

MODEL  
Modellname:  
Nazwa modelu:

**DAKOTA**





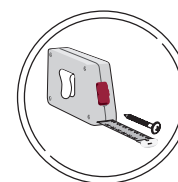
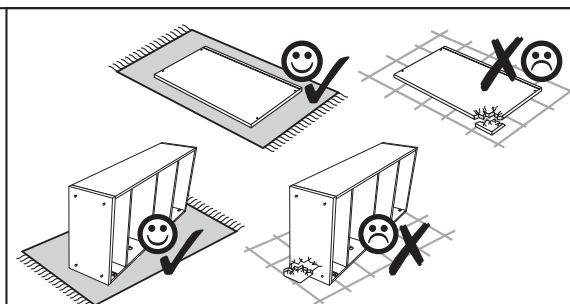
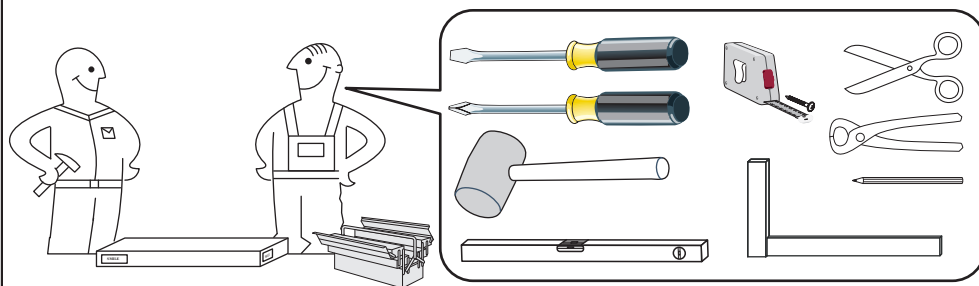
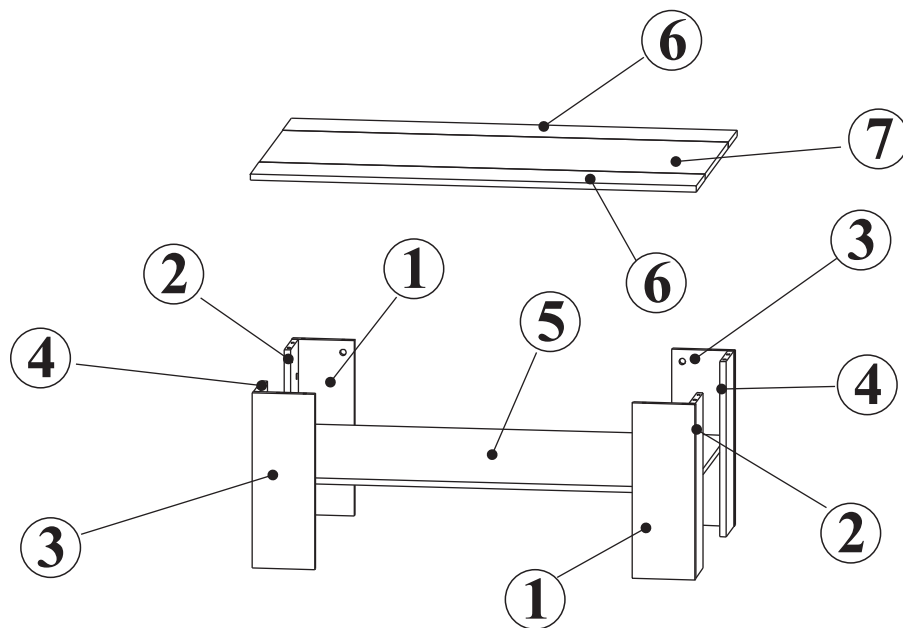
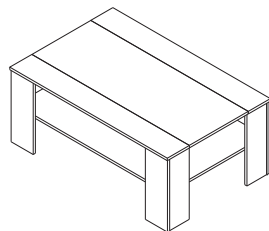
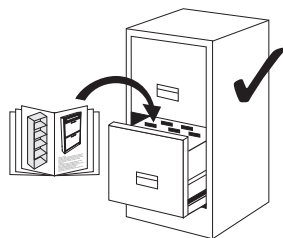

MODEL  
Modellreihe: **83-300-..-8**  
Numer modelu:

Type:  
Typ:

Blatt Nr 1 von: 2  
Strona z: 2

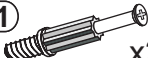

STRANA

NR 1	Č. 1
<b>B1</b>	 x24 φ 8x28
<b>B2</b>	 x8 φ 10x50
<b>M1</b>	 x36
<b>T1</b>	 x24
<b>T12</b>	 x6
<b>C2</b>	 x16
<b>F15</b>	 x8
<b>L1</b>	 x1

MODEL  
Modellname:  
Nazwa modelu:

**DAKOTA**

MODEL  
Modellreihe:  
Numer modelu:

**83-300-..-8**

Type:  
Typ:

Blatt Nr  
Strona

von:  
z:

