

Jennifer

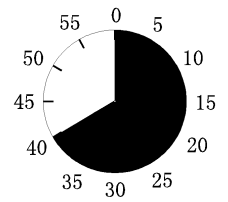

1

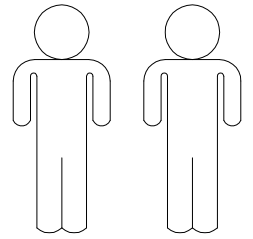
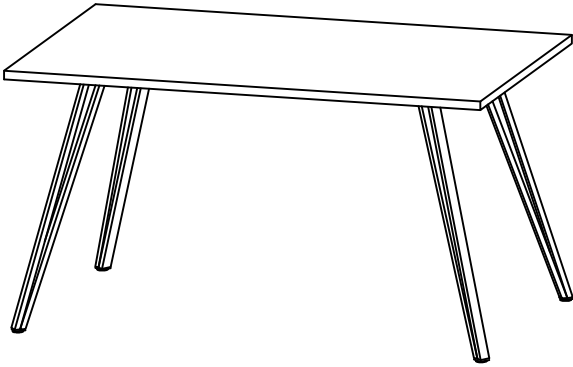
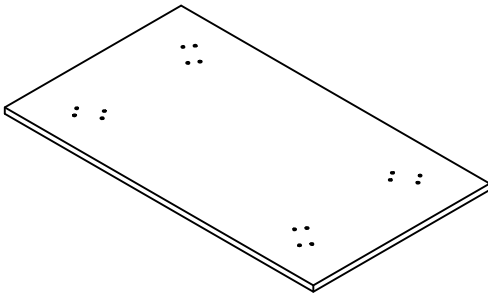

2

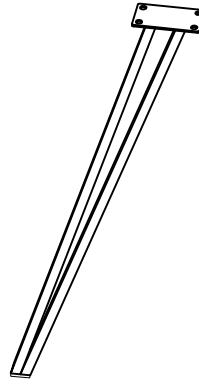

1	1x	1/2
2	4x	2/2

A

M8*18



16X

B

M8*20



16X

C

Ø18*Ø8*1.5



16X

D

Ø25



4X

E

5mm



1X

F

8mm

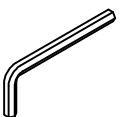

1X

I.

1.

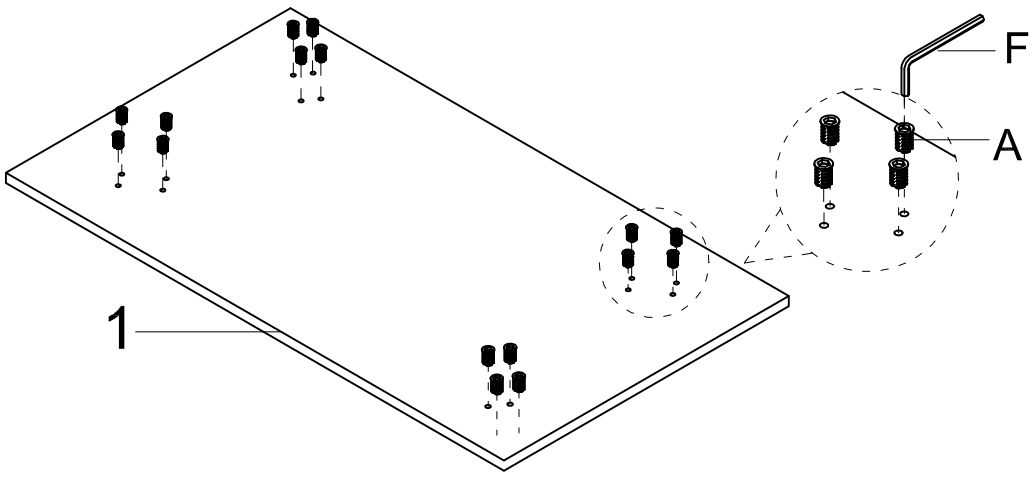

- A M8*18 16X
- F 8mm 1X
- 100%

2.

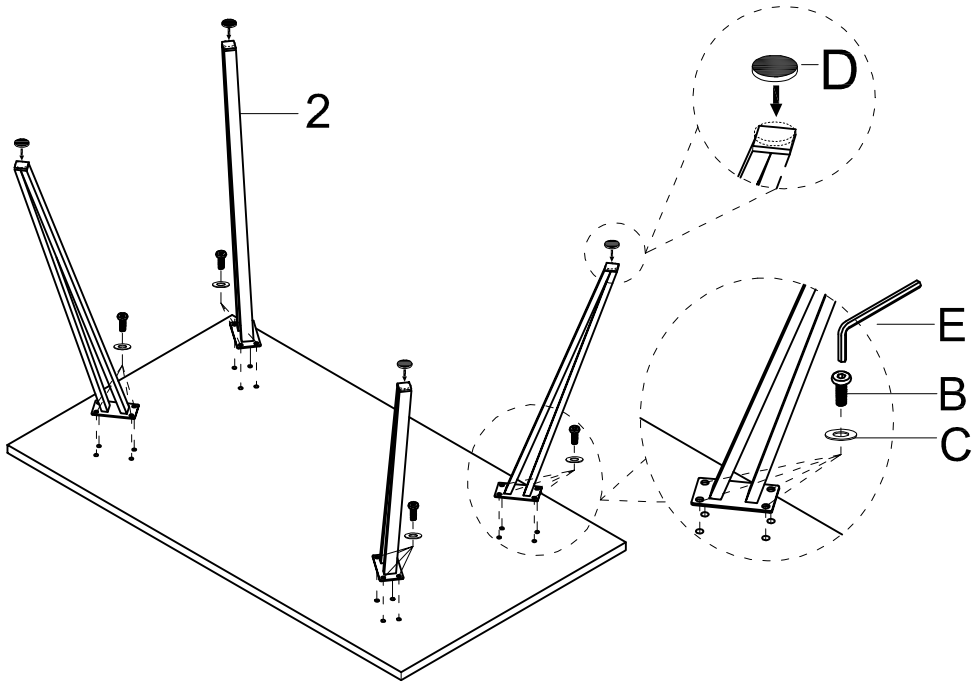

- B M8*20 16X
- C Ø18*Ø8*1.5 16X
- D Ø25 4X
- E 5mm 1X
- 100%

3.

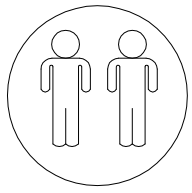

!

