

| A  | B         | C1   | C2   | C3  | D       |
|----|-----------|------|------|-----|---------|
| 1  | L109-0001 | 2145 | 500  | 29  | 7/9     |
| 2  | L109-0002 | 2145 | 500  | 29  | 8/9     |
| 3  | L109-0003 | 2145 | 500  | 29  | 6/9     |
| 4  | L109-1001 | 2200 | 575  | 36  | 4/9     |
| 5  | L109-1002 | 2200 | 575  | 36  | 4/9     |
| 6  | L109-1003 | 2200 | 545  | 18  | 3/9     |
| 7  | L109-1004 | 2200 | 545  | 18  | 6/9     |
| 8  | L109-3006 | 1000 | 510  | 22  | 5/9     |
| 9  | L109-3007 | 486  | 510  | 22  | 2/9 9/9 |
| 10 | L109-4003 | 450  | 86   | 10  | 2/9     |
| 11 | L109-4004 | 1269 | 86   | 10  | 2/9     |
| 12 | L109-5001 | 599  | 100  | 32  | 2/9     |
| 13 | L109-5002 | 599  | 100  | 32  | 2/9     |
| 14 | L109-5003 | 1325 | 100  | 32  | 2/9     |
| 15 | L109-5004 | 1325 | 100  | 32  | 2/9     |
| 16 | L109-9001 | 2130 | 494  | 2,5 | 3/9     |
| 17 | L109-9301 | 2130 | 1011 | 2,5 | 3/9     |
| 18 | L109-Z001 | 1000 | 545  | 66  | 1/9     |
| 19 | L109-Z002 | 486  | 545  | 66  | 1/9     |
| 20 | L109-Z003 | 1000 | 545  | 16  | 2/9     |
| 21 | L109-Z004 | 486  | 545  | 16  | 2/9     |
| 22 | L109-Z005 | 1000 | 545  | 16  | 2/9     |
| 23 | dr-987    | 987  | 30   | 15  | 2/9     |

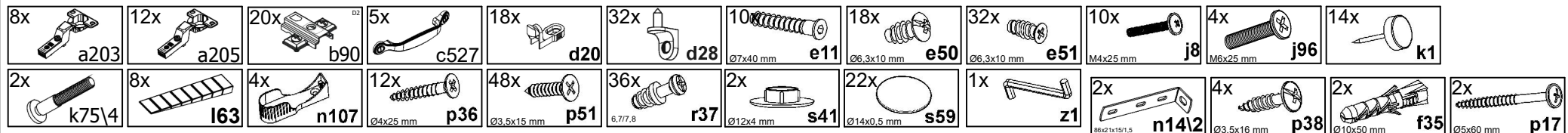

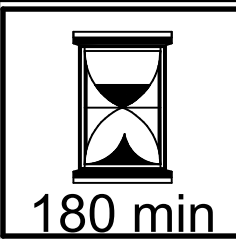

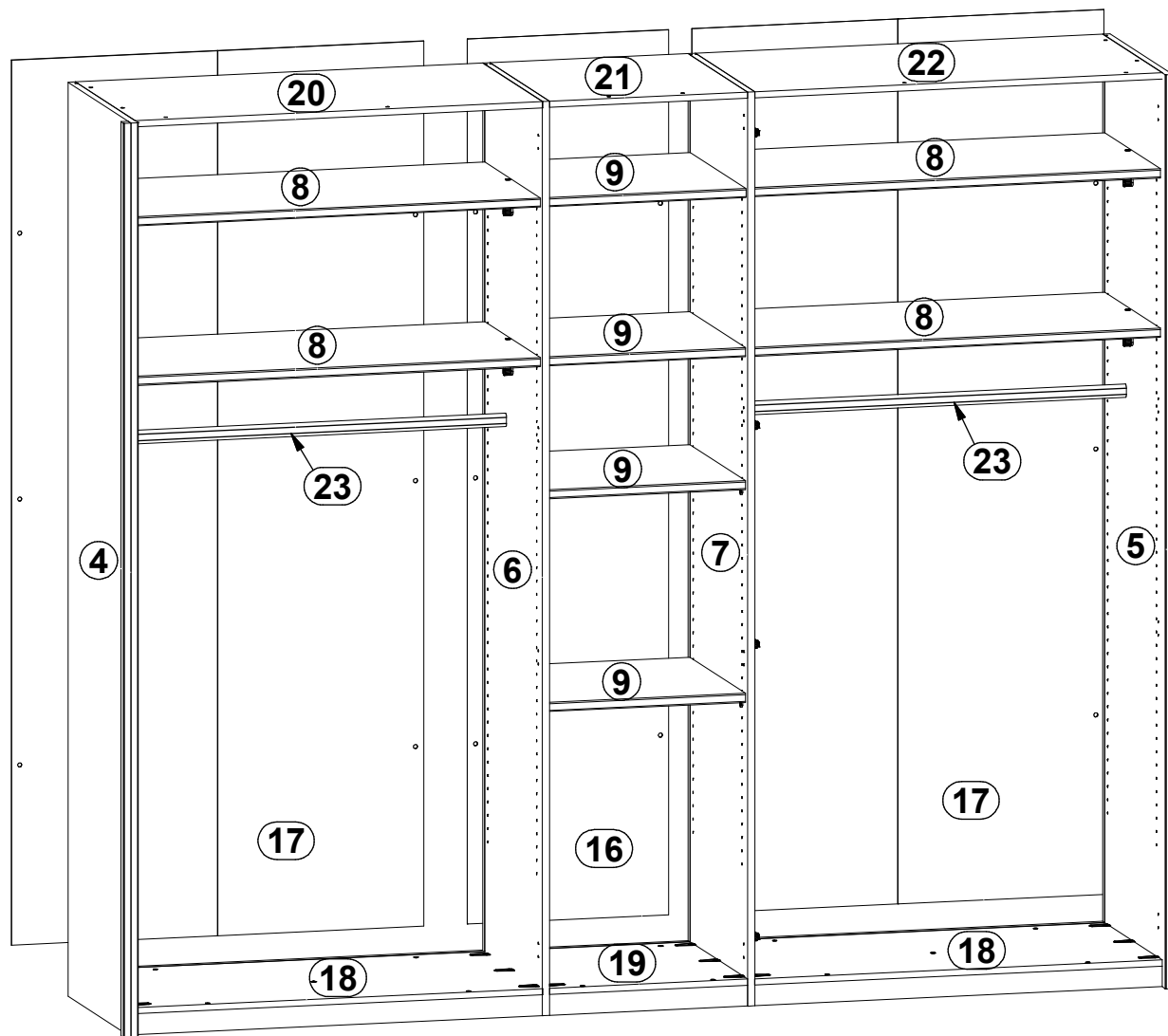
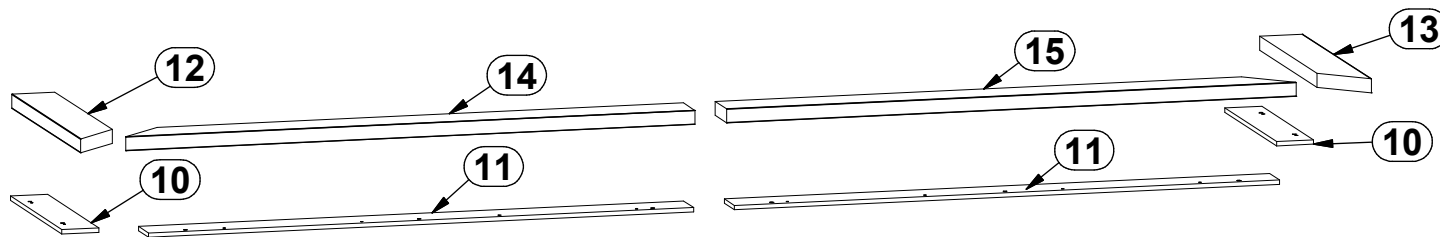
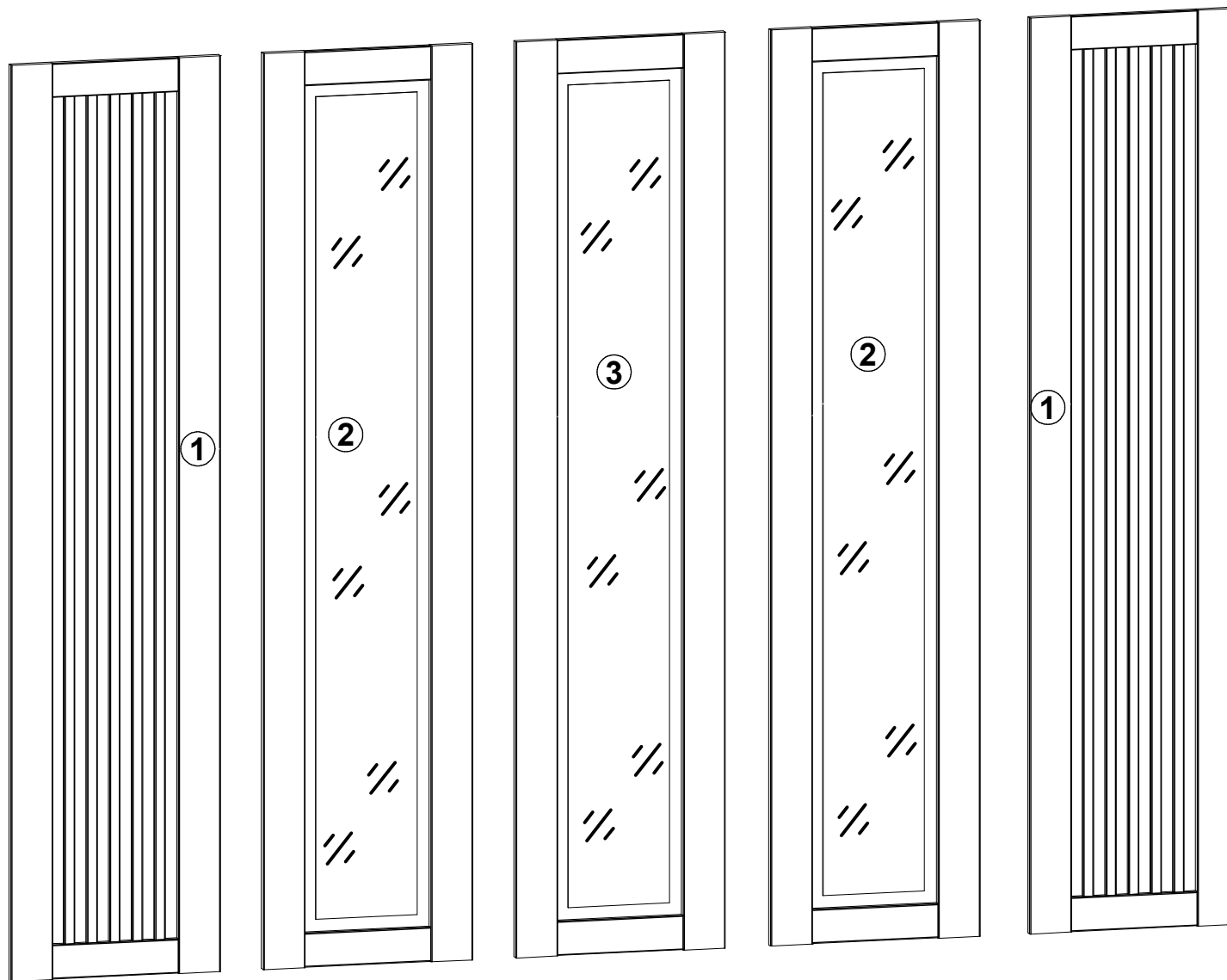

1

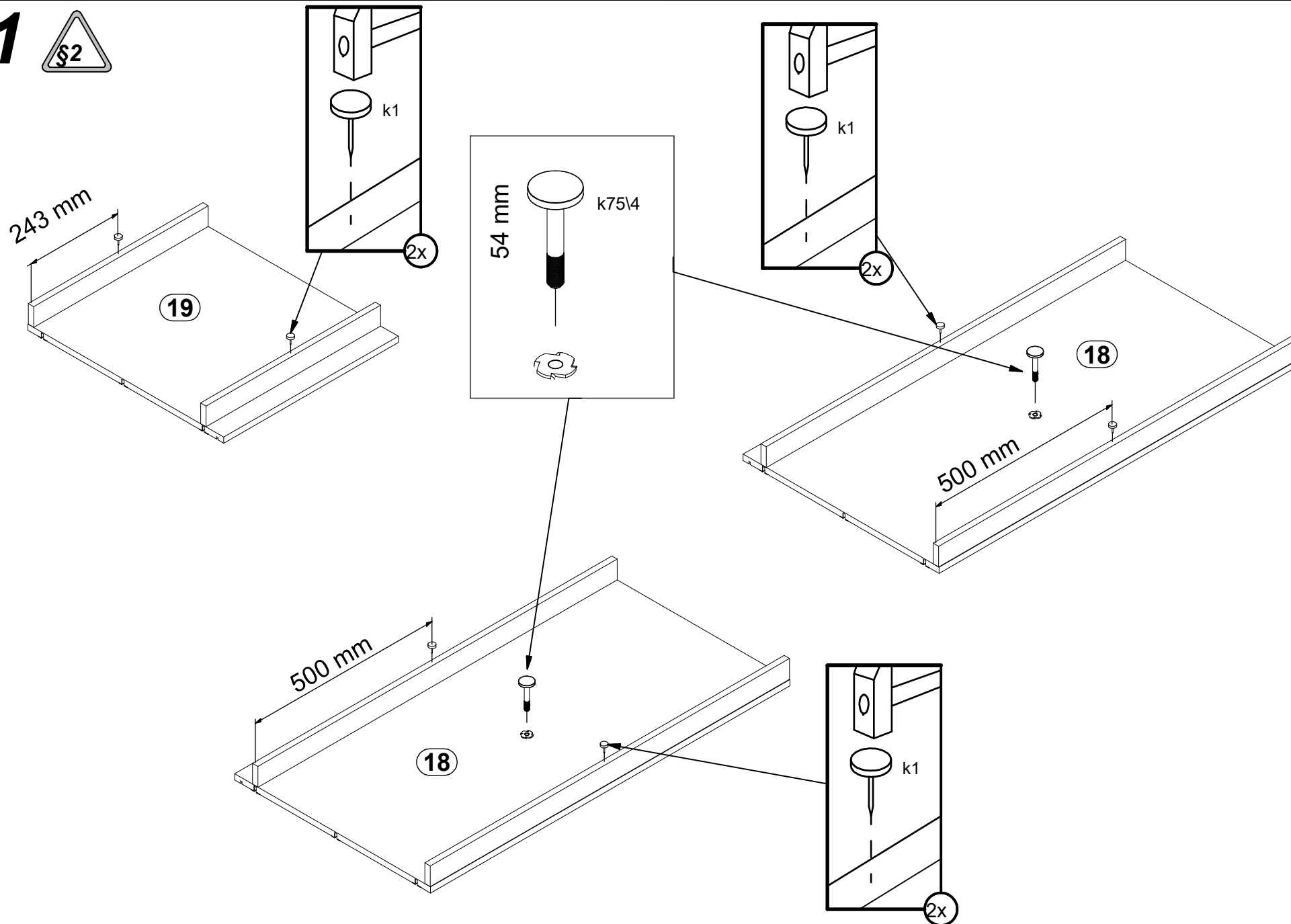

1

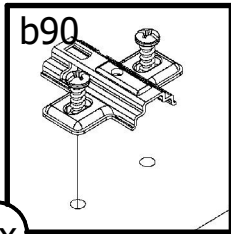
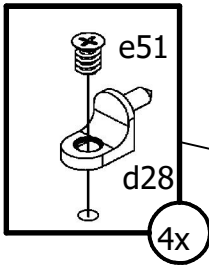
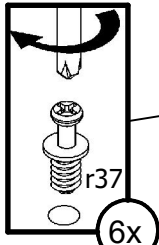

4x

5

e51  
d28

6x

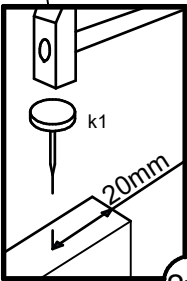

2x

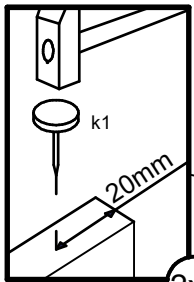

2x

4

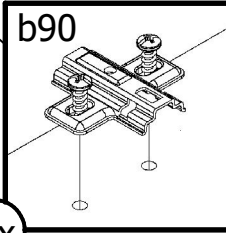

4x

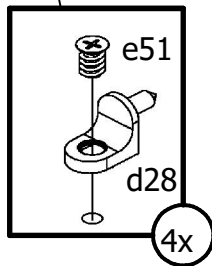

4x

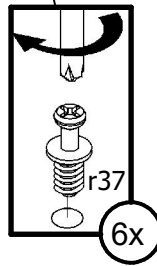

6x

1

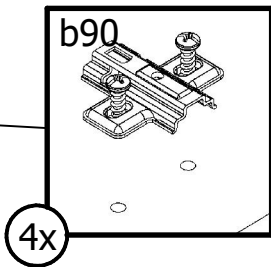
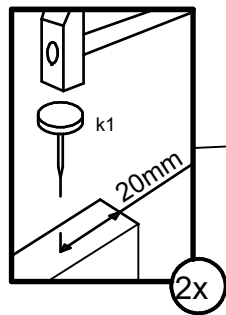
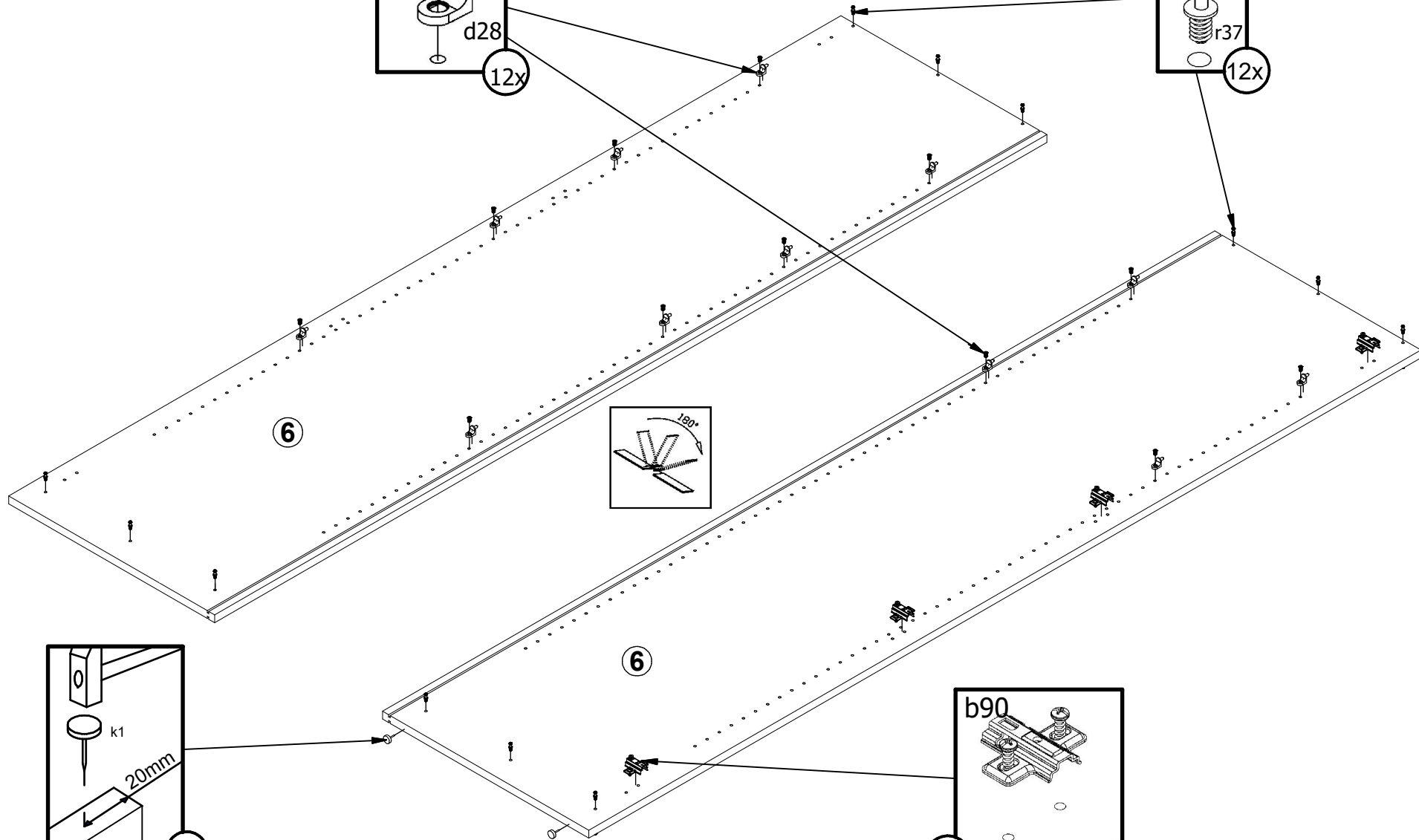
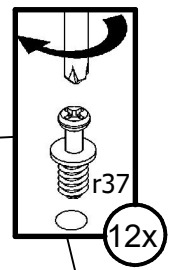
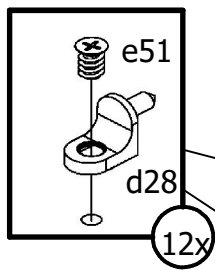

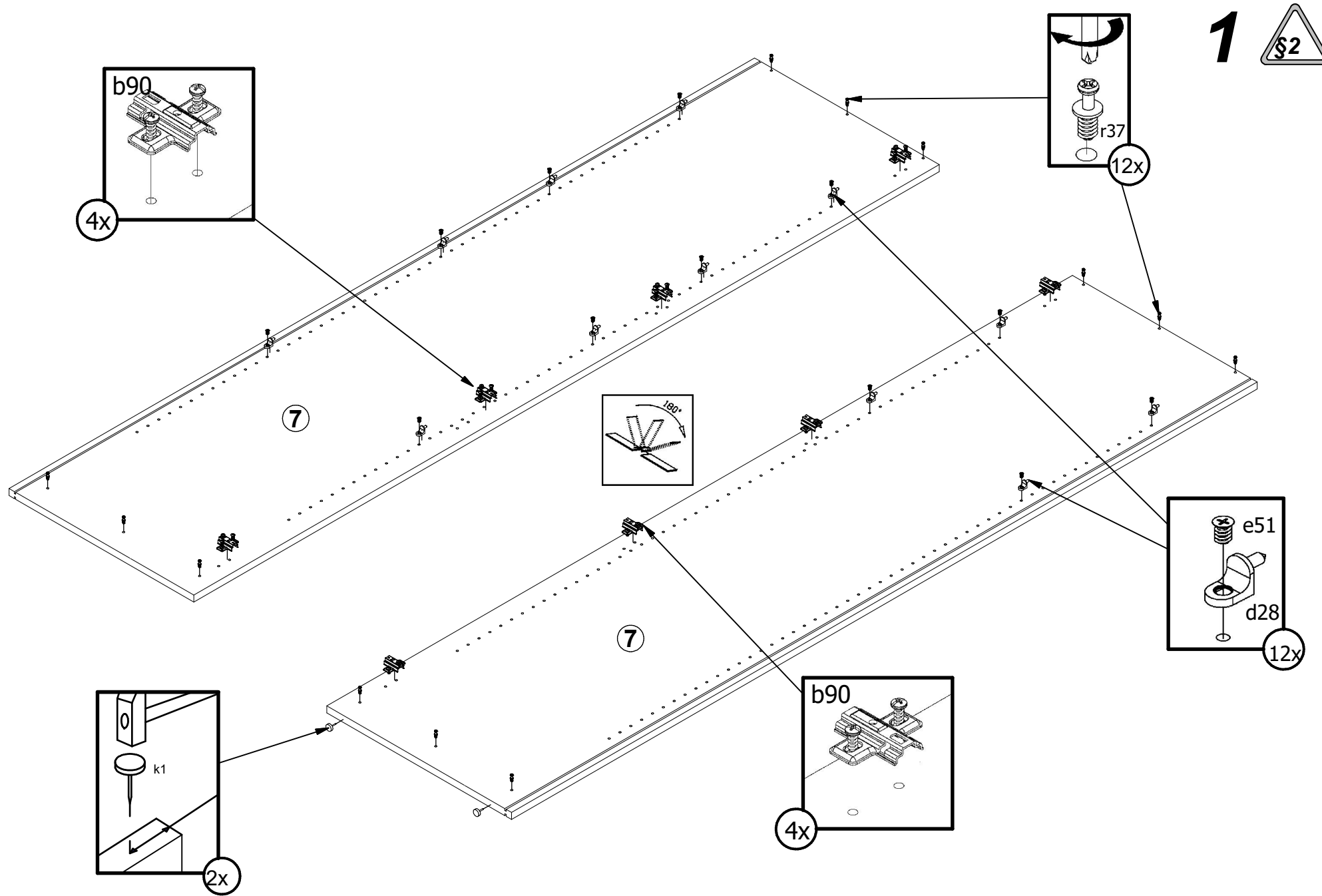



**1** 

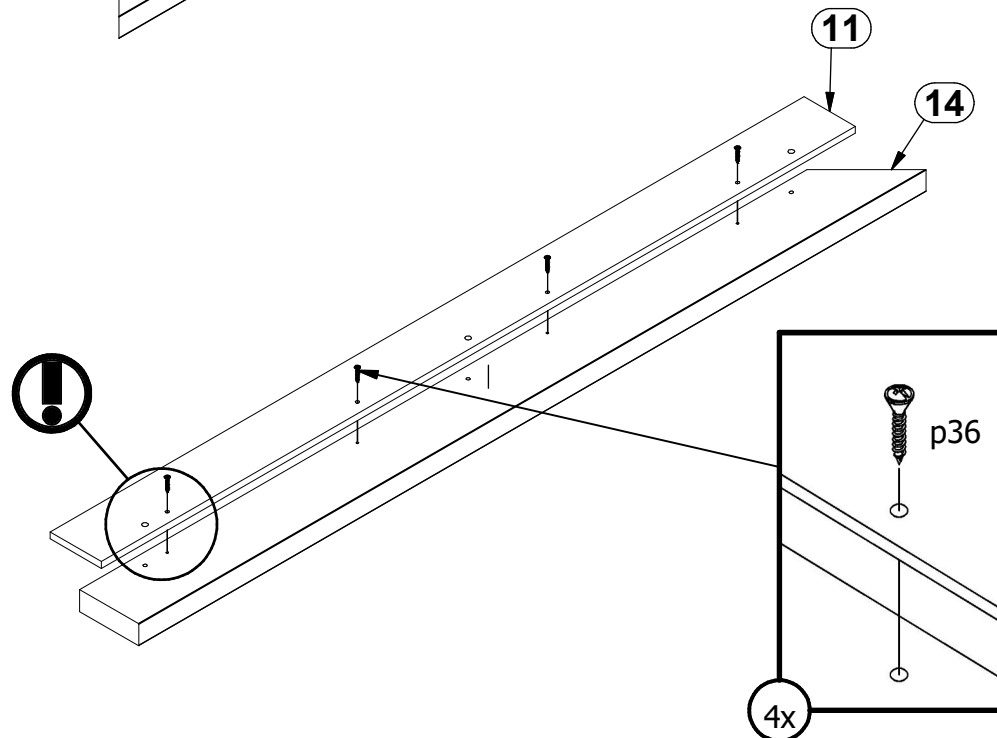
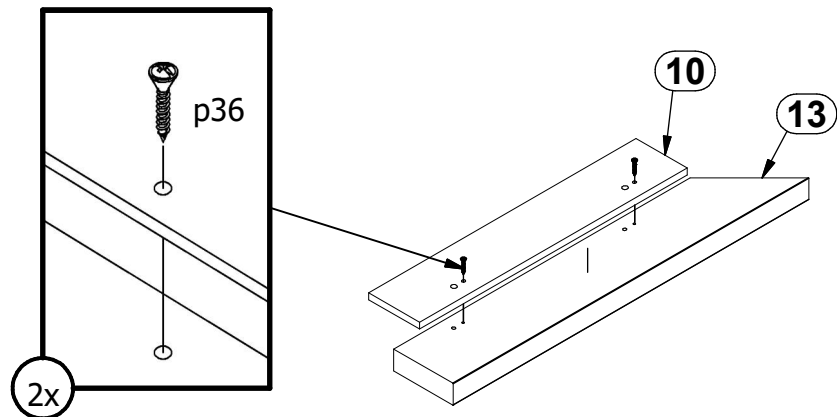
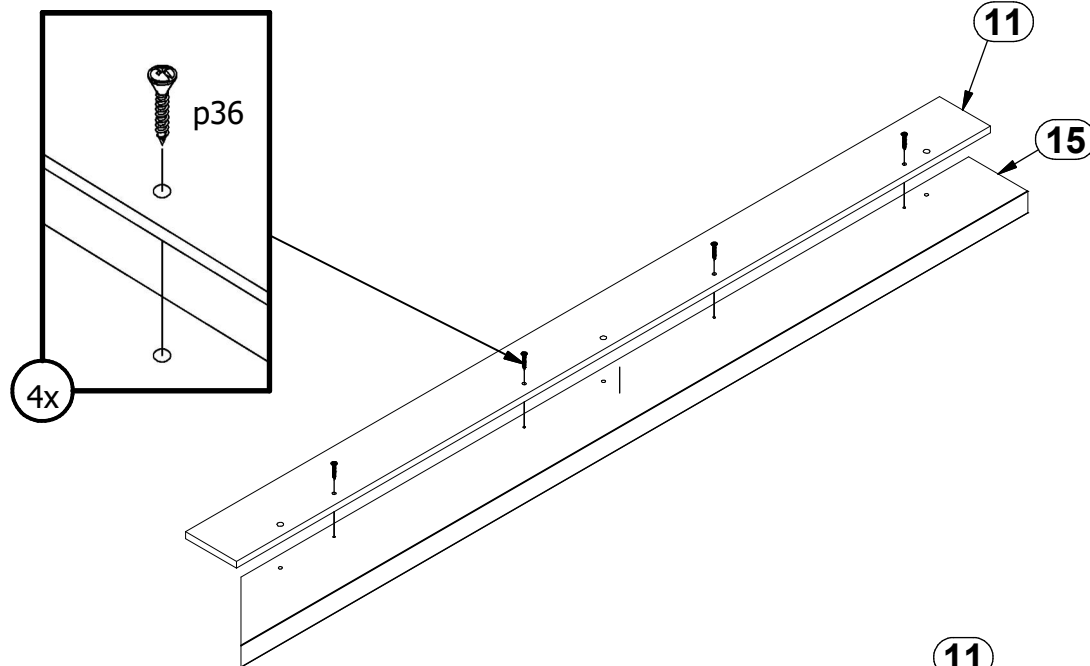
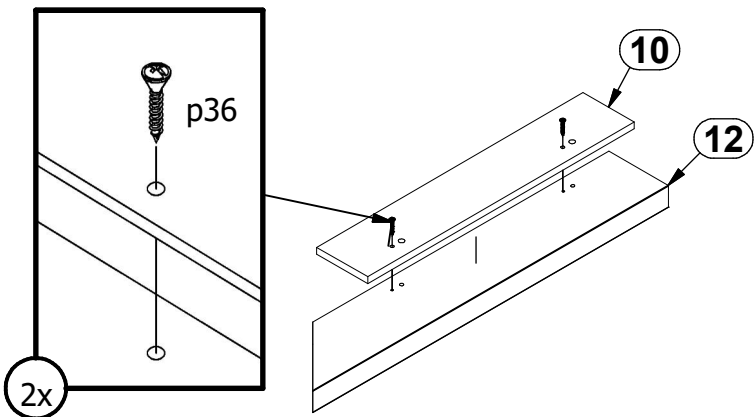

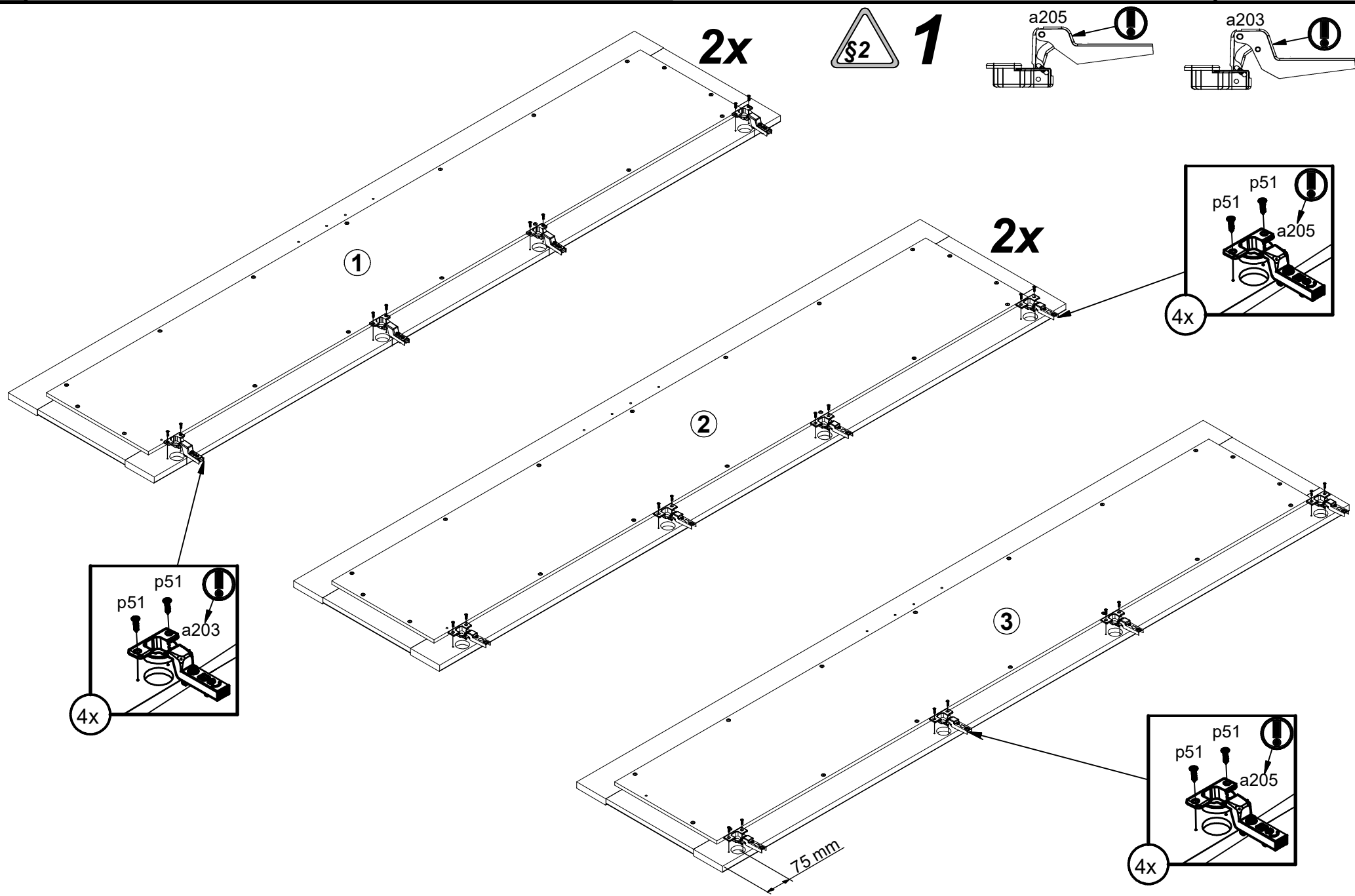

2 

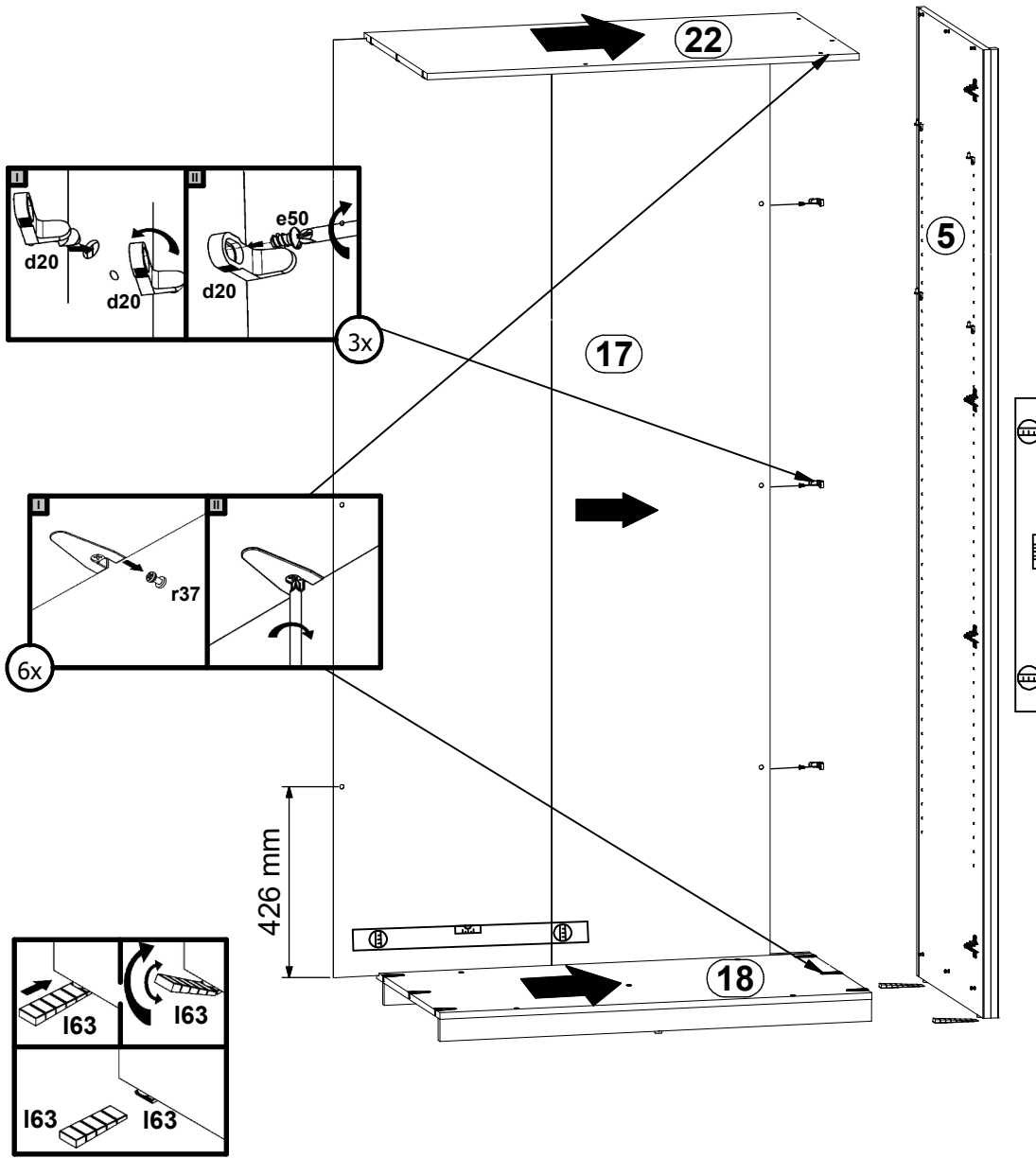

3

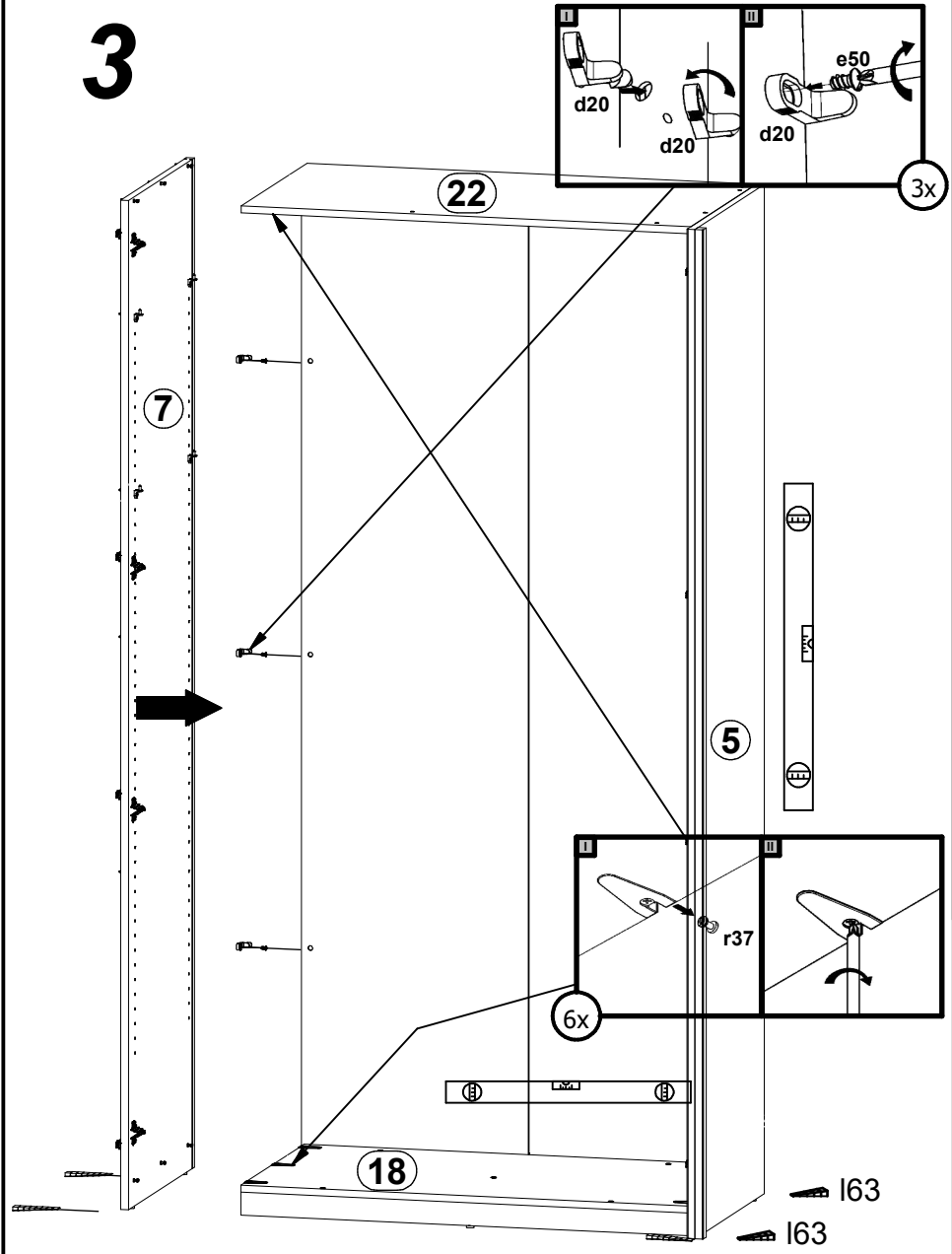

4

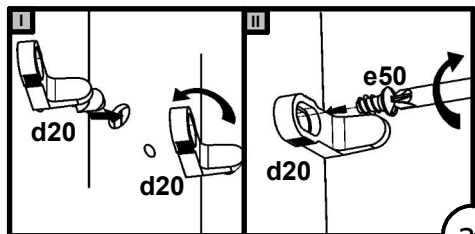

3x

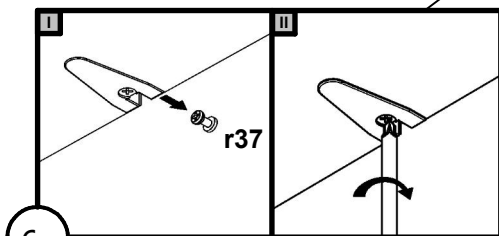

6x

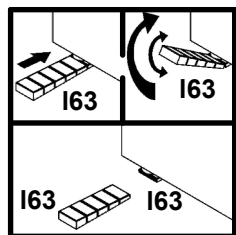

433 mm

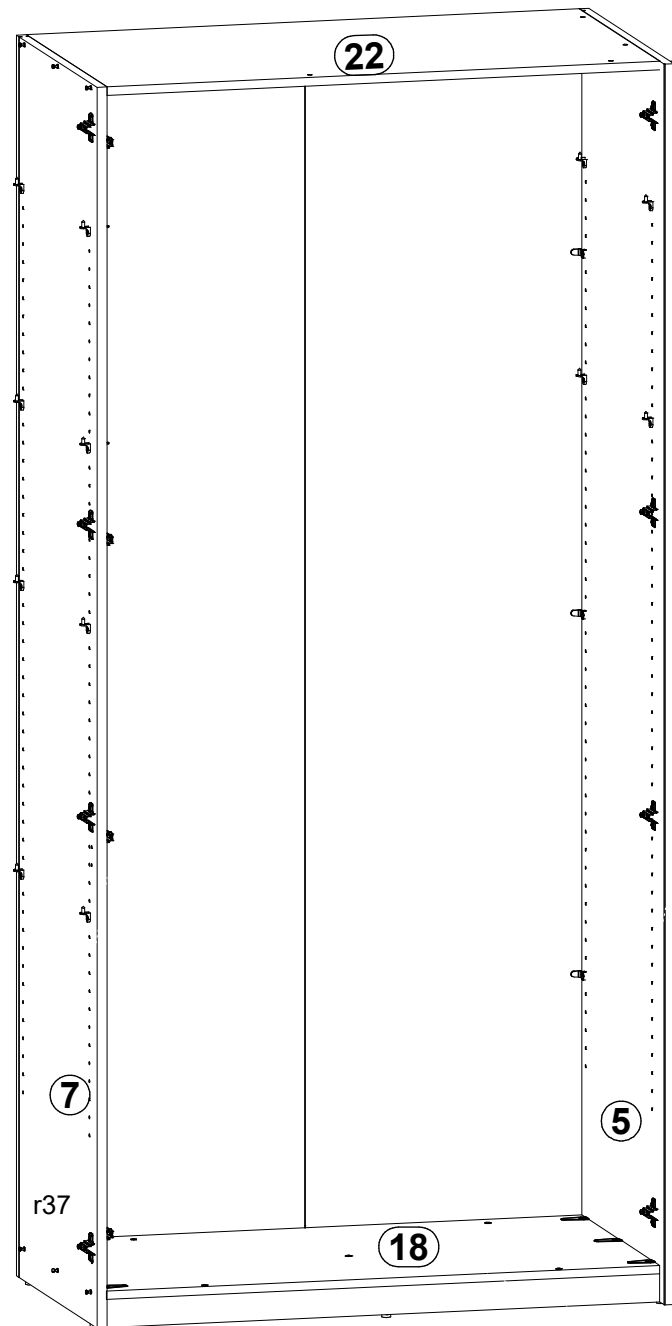
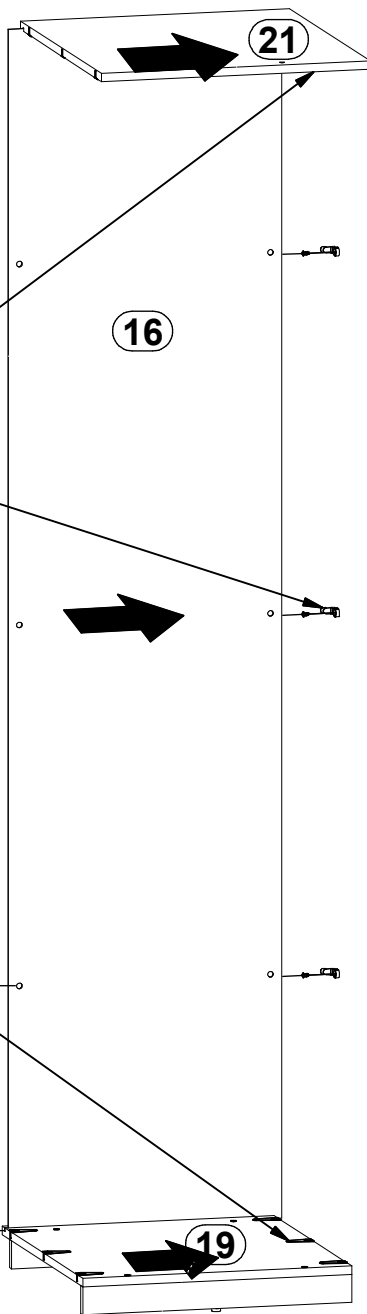

5

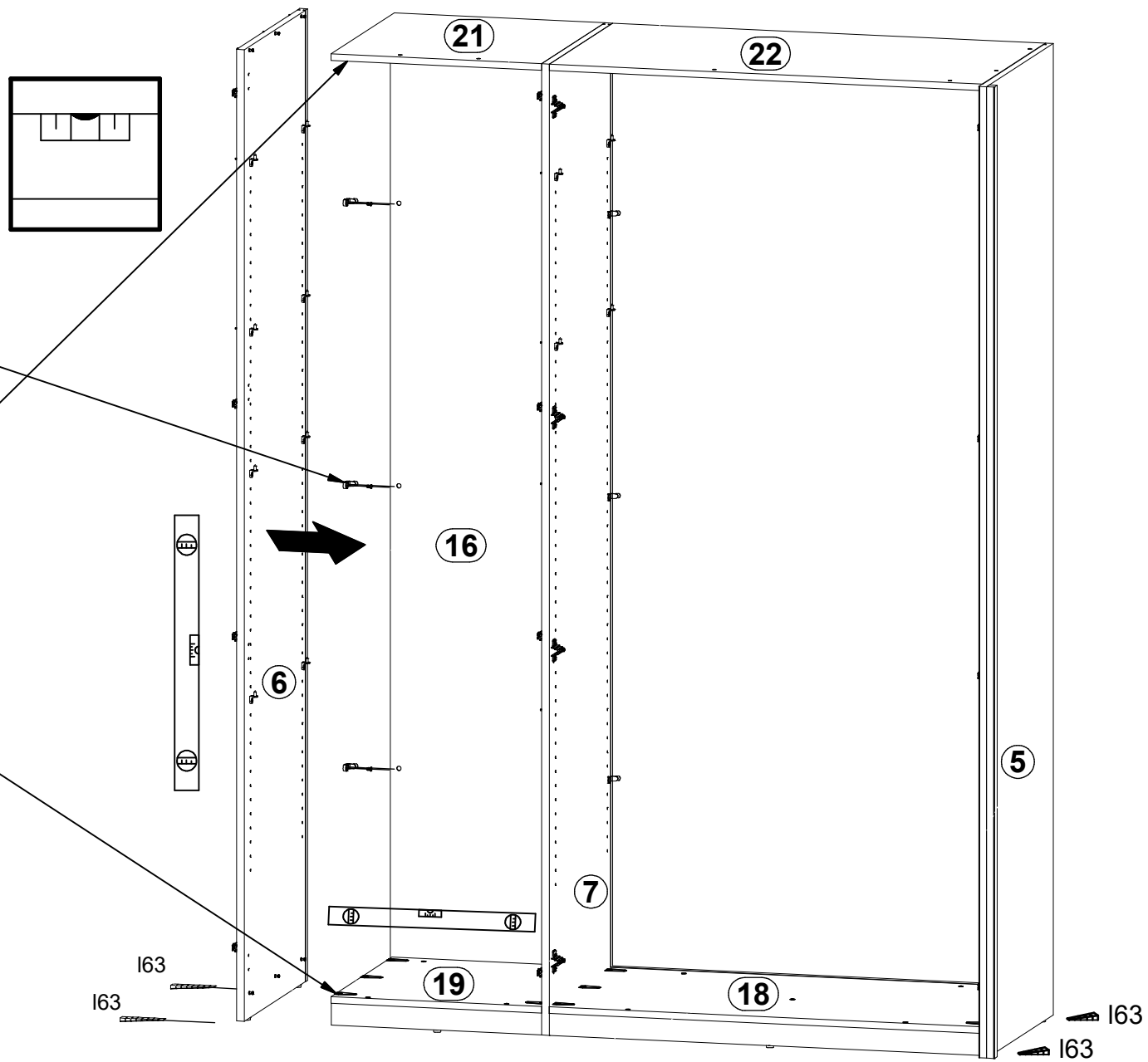
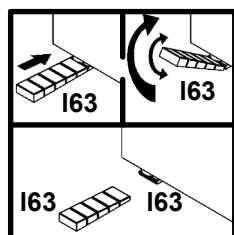
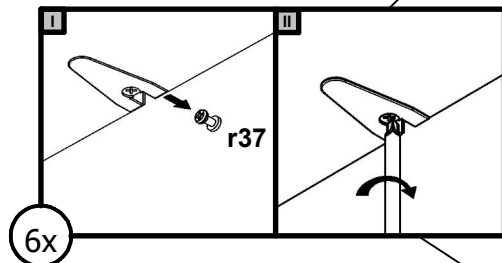
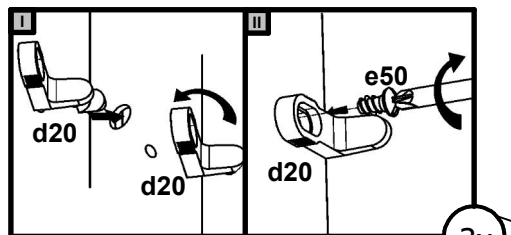

6

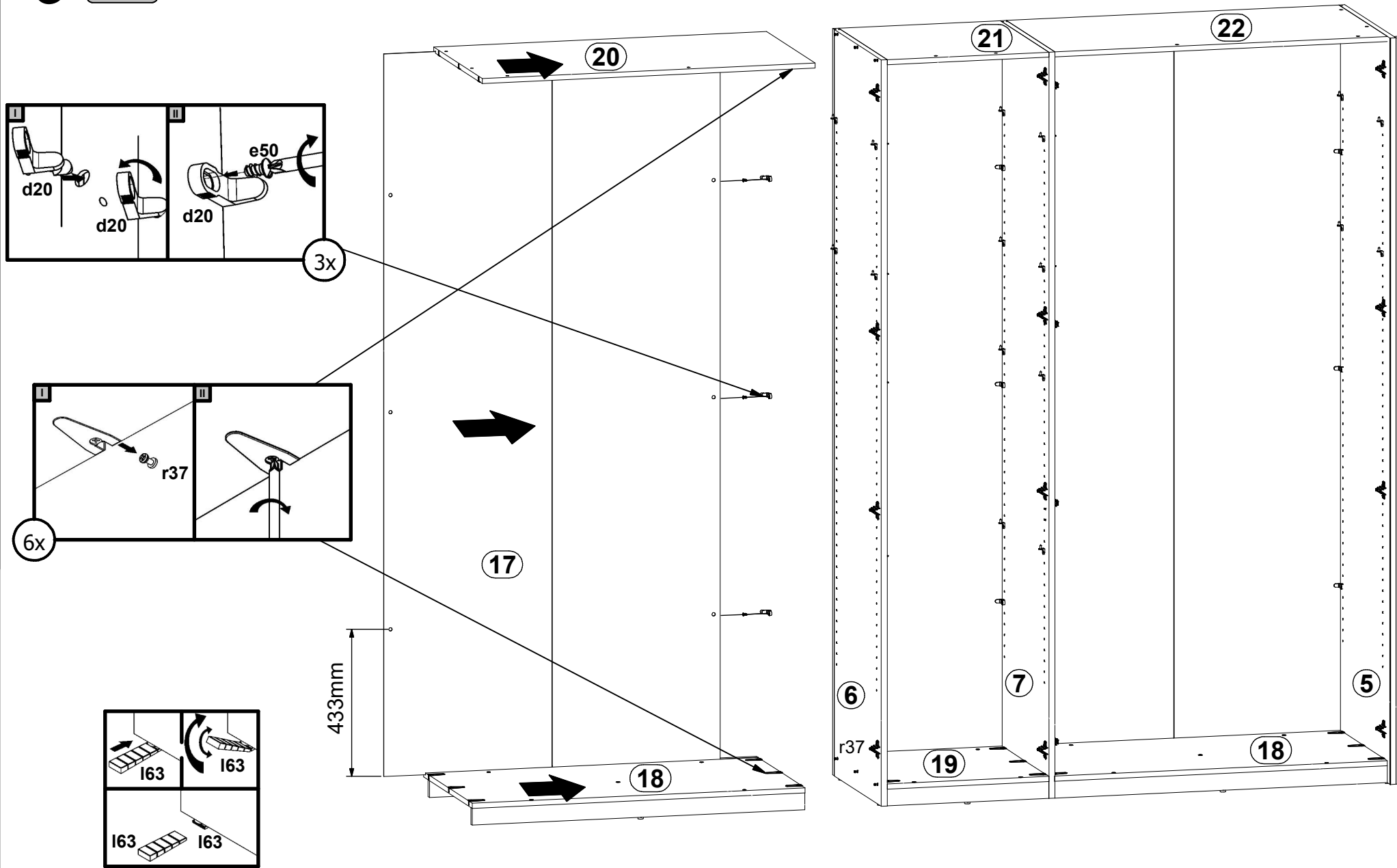

7

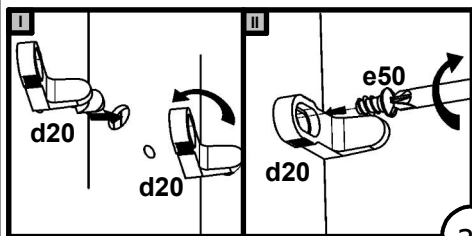

3x

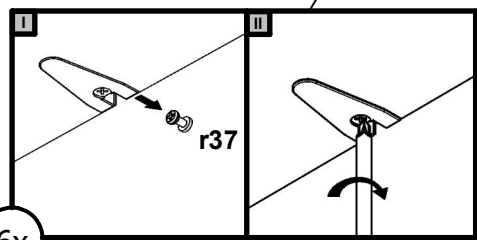

6x

4

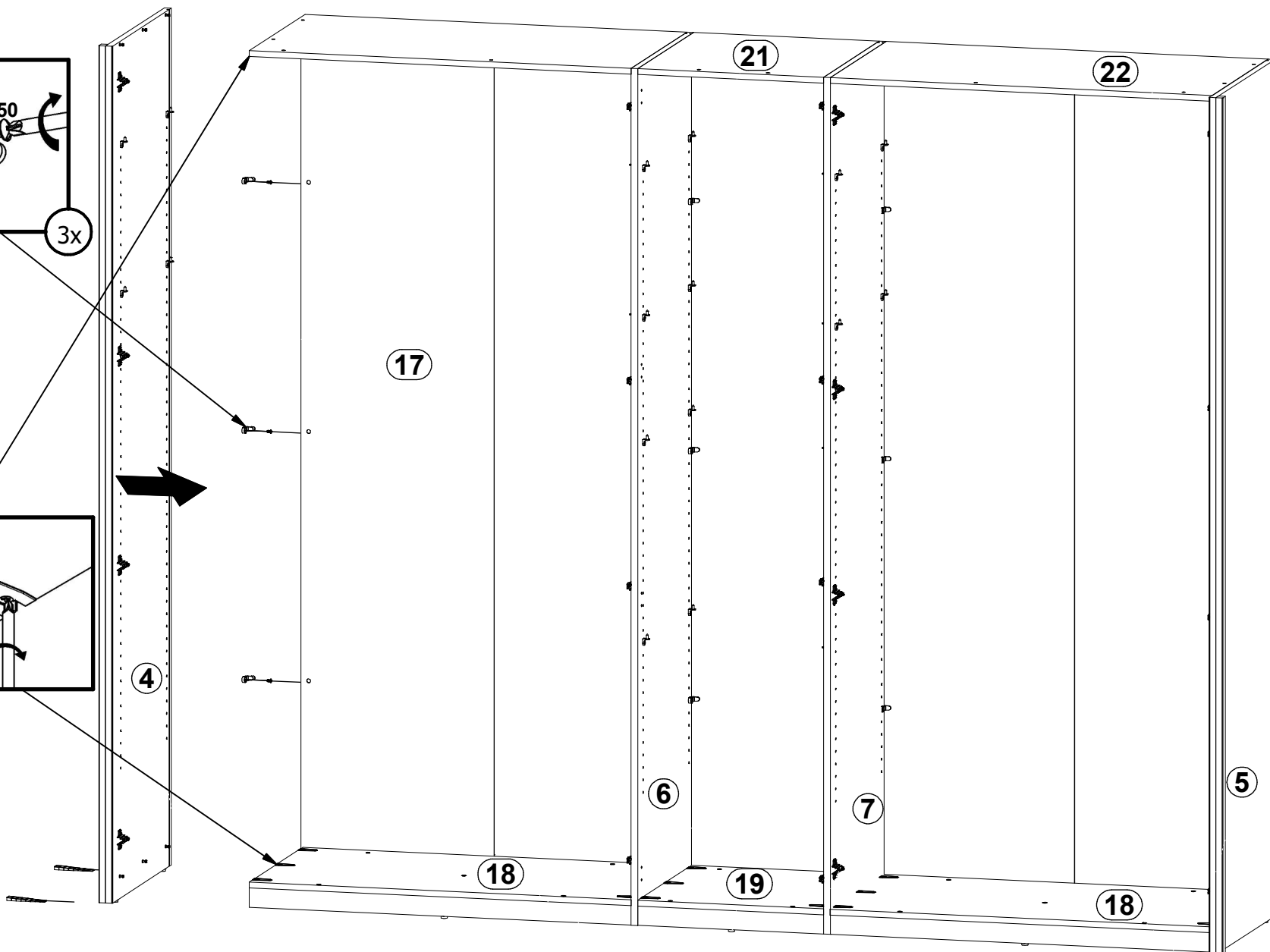
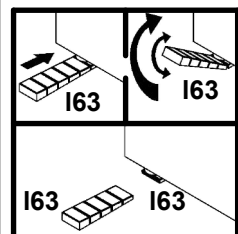

17

21

22

6

7

5

18

19

18

8

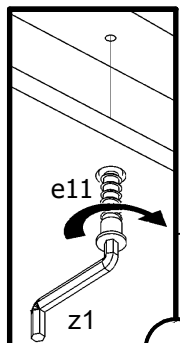

10x

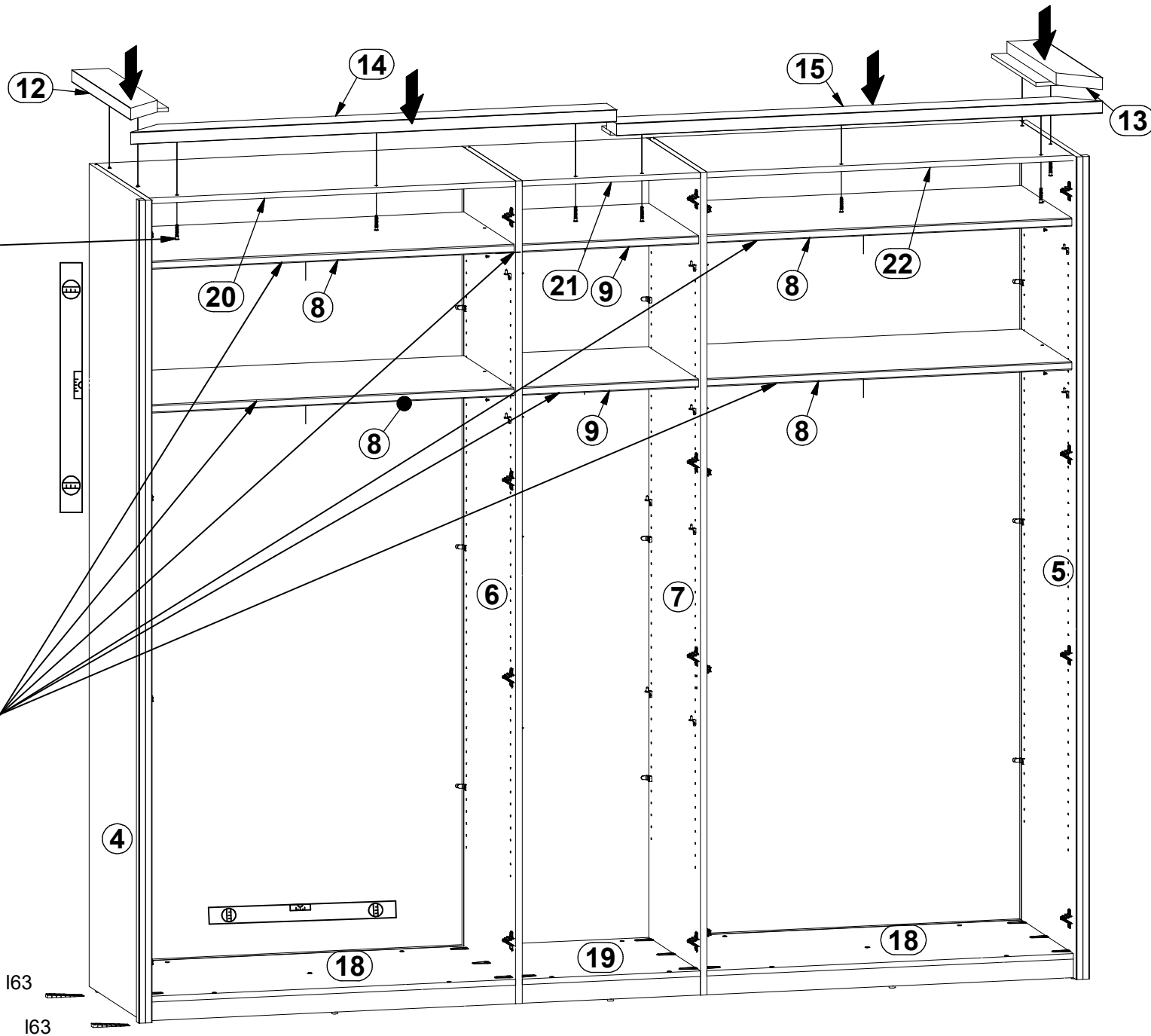
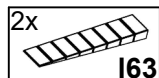
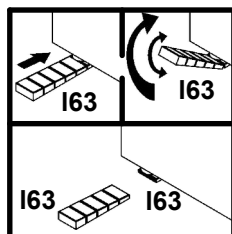
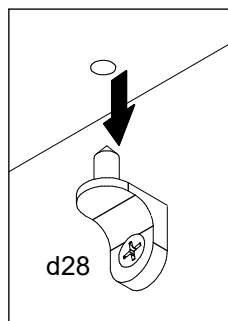
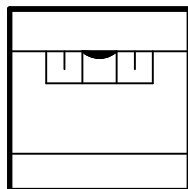



9

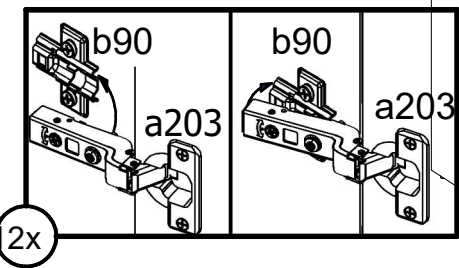
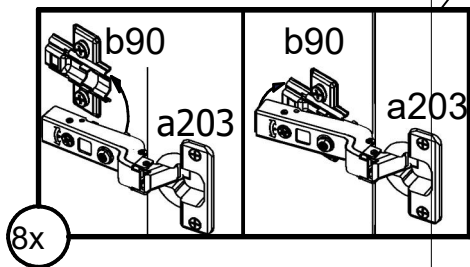
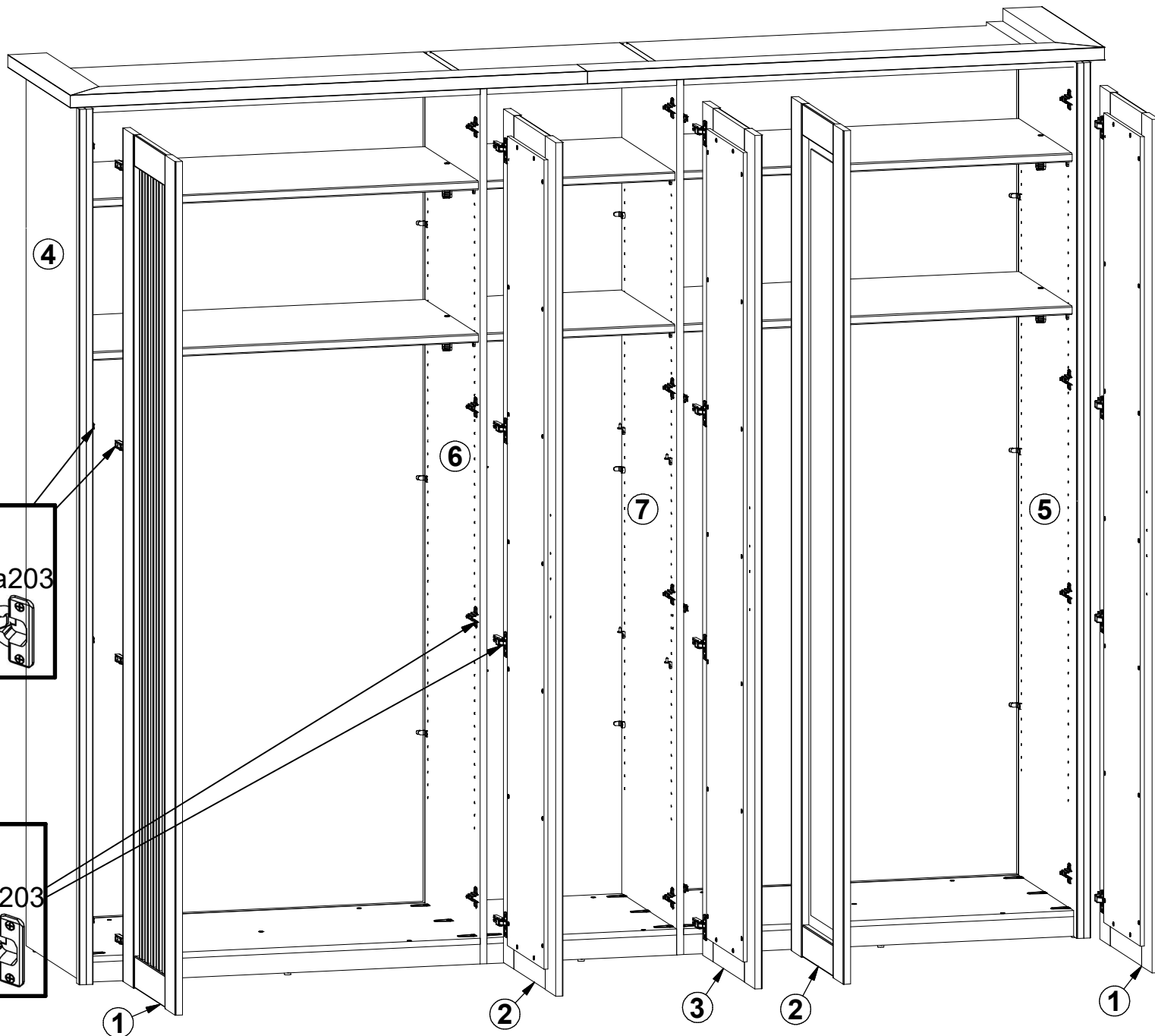

# 10

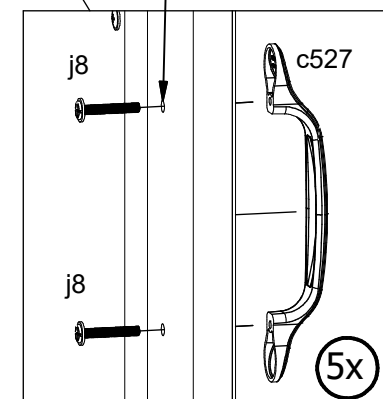
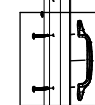
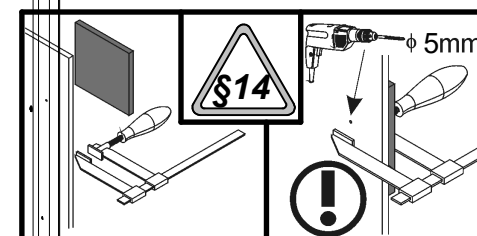
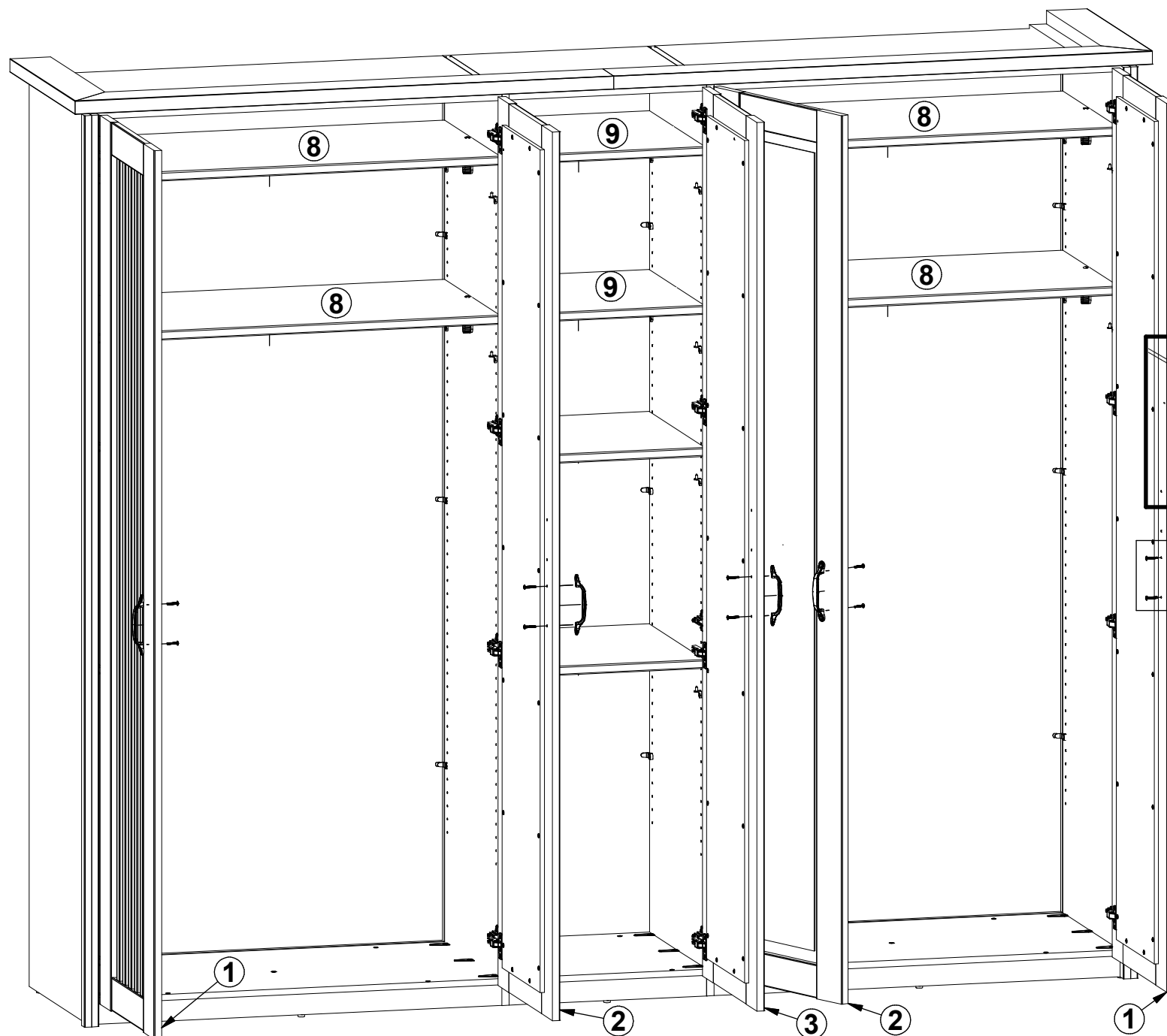

11

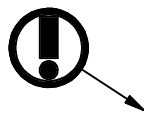
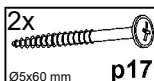
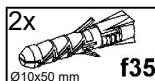
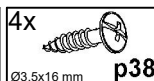
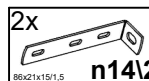

n14/2 p38

n14/2 p38

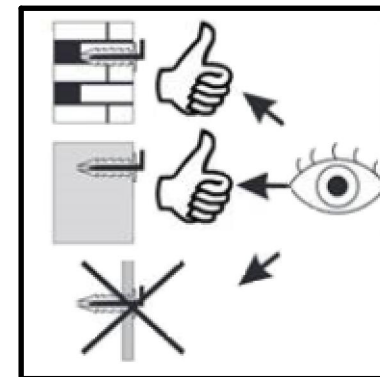
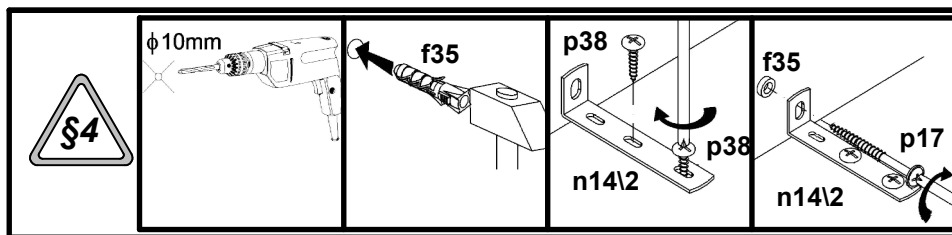
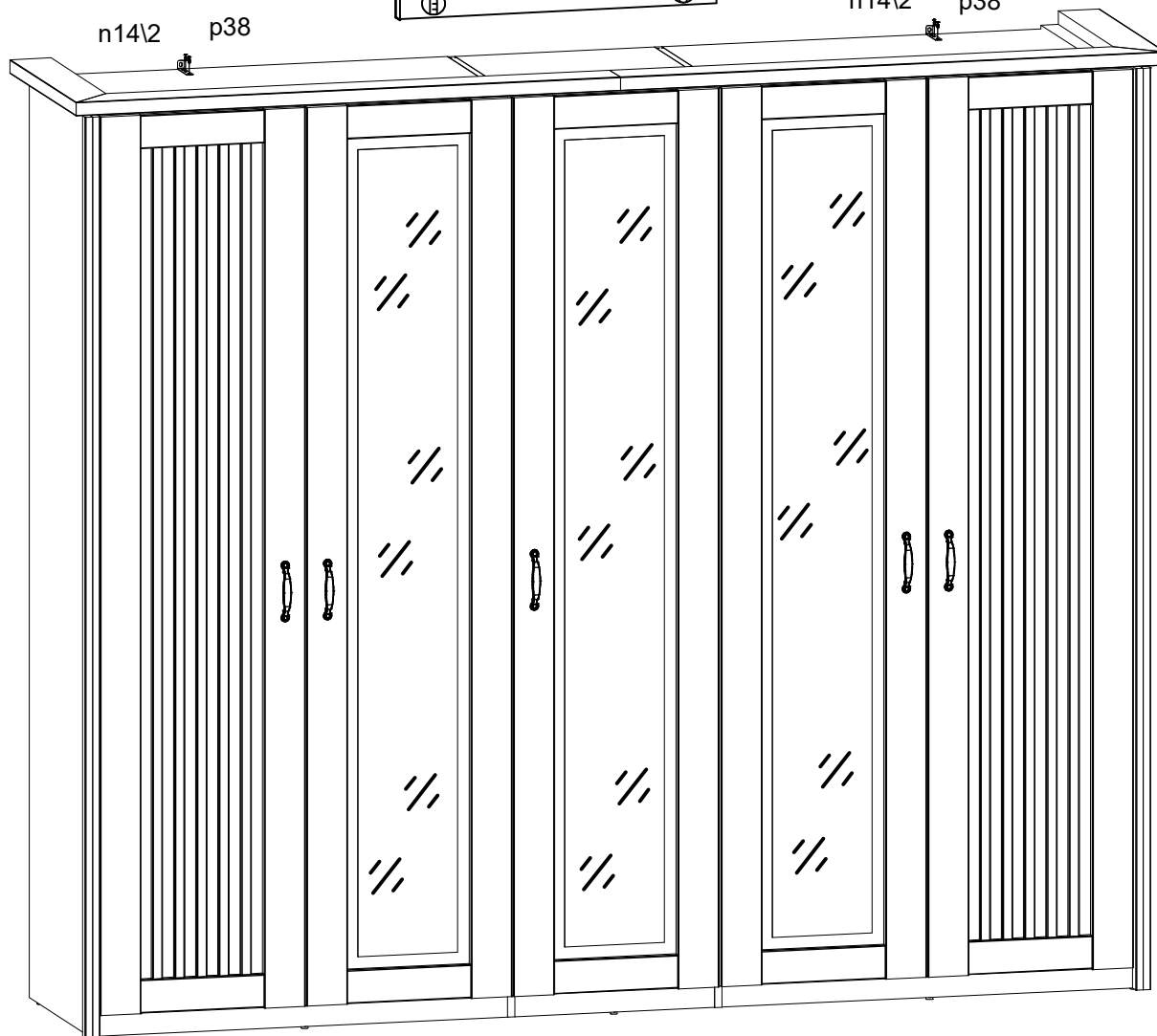

12

