

RIVA RVK23B

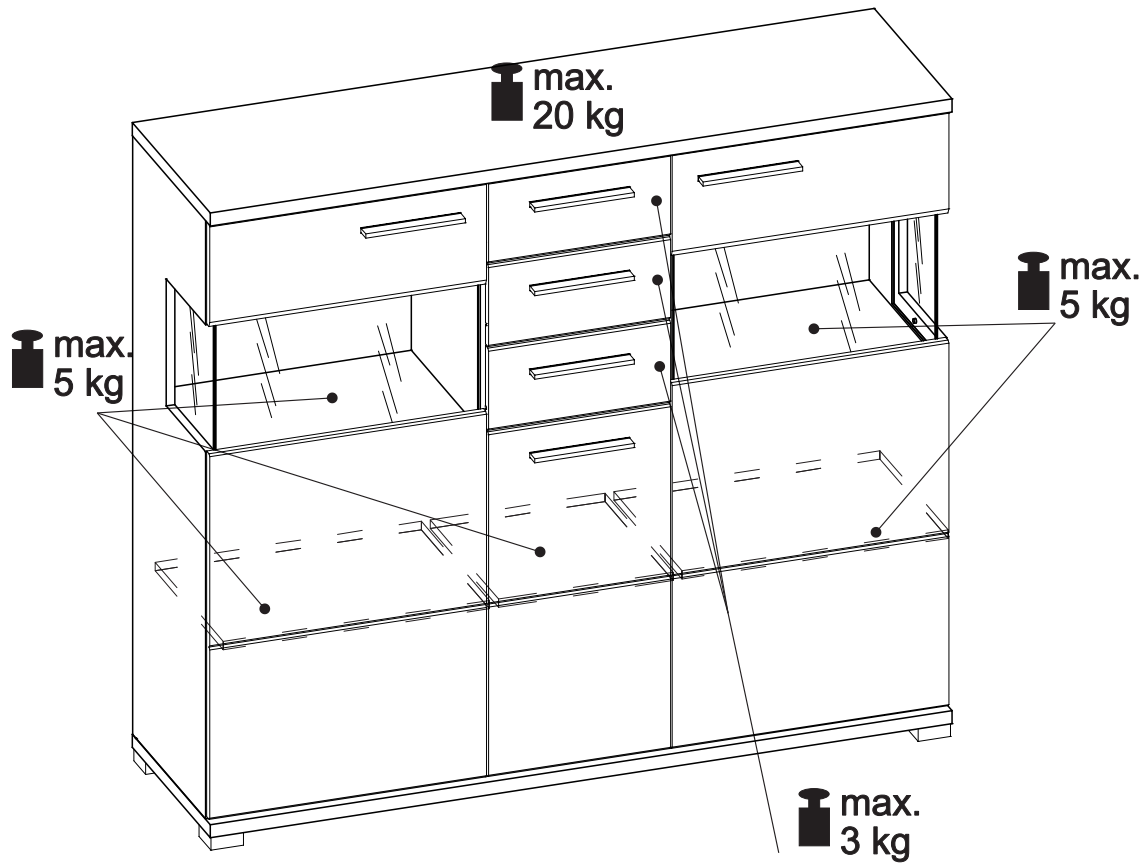

- ① -C2 ② -C2 ③ -C2 ④ -C2 ⑤ -C1
- ⑥ -C1 ⑦ -C1 ⑧ -C1 ⑨ -C2 ⑩ -C2
- ⑪ -C2 ⑫ -C1 ⑬ -C1 ⑭ -C1 ⑮ -C1
- ⑯ -C2 ⑰ -C1 ⑱ -C2 ⑲ -C2 ⑳ -C1
- ㉑ -C1 ㉒ -C1 ㉓ -C1 ㉔ -C2



RIVA RVK23B

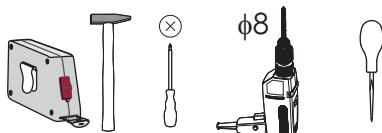
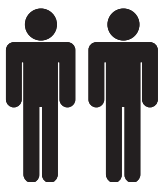
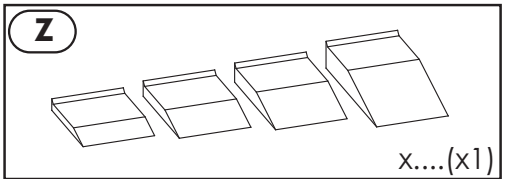
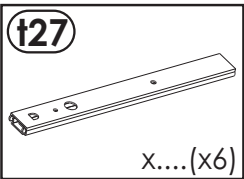
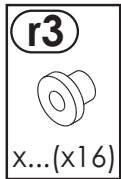
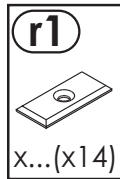
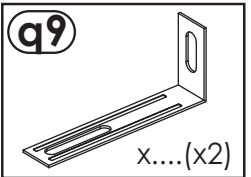
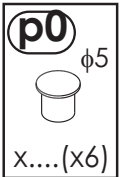
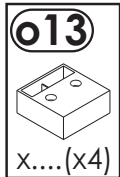
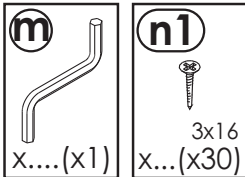
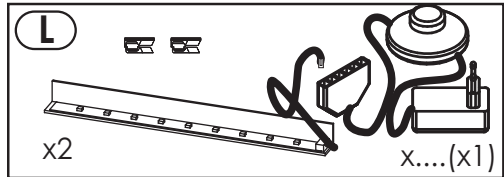
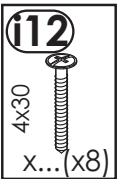
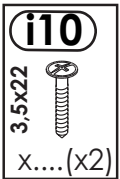
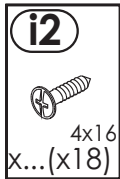
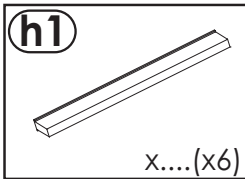
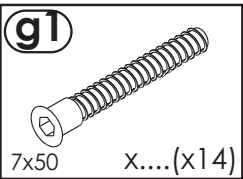
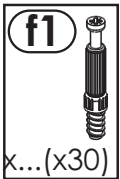
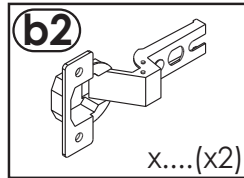
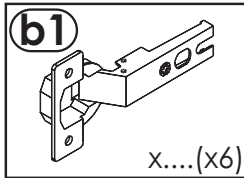
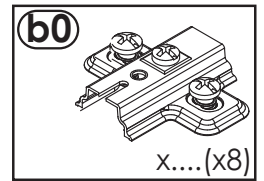
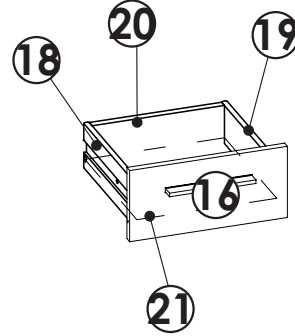
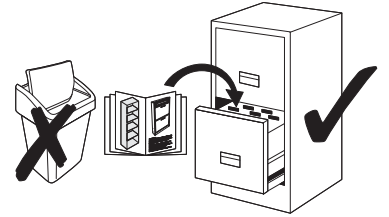
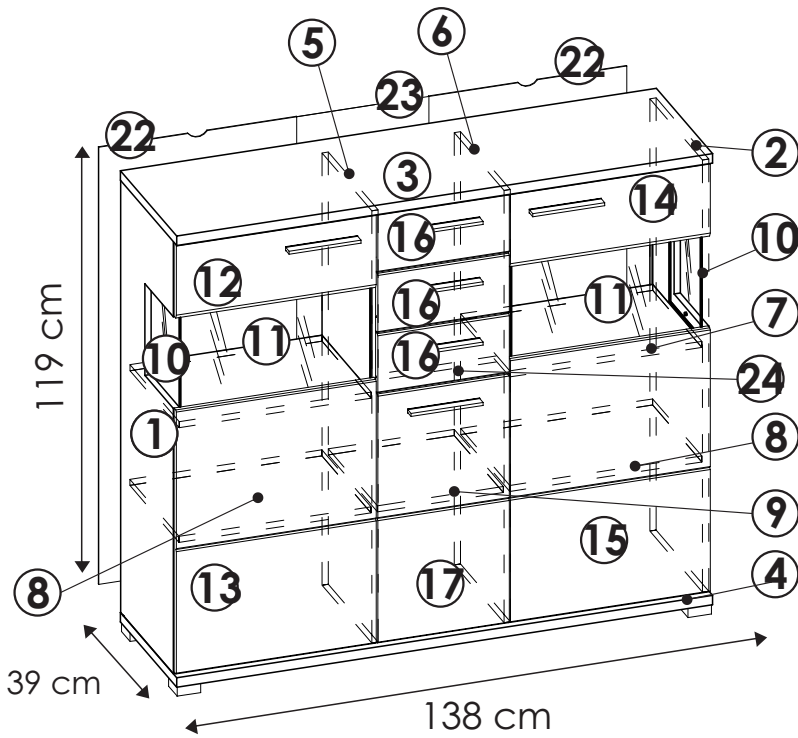

1

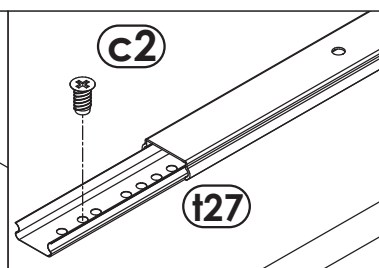
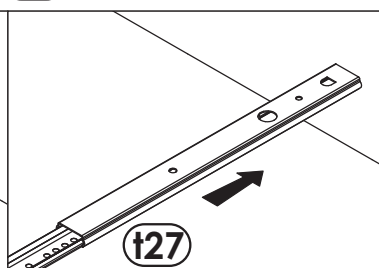
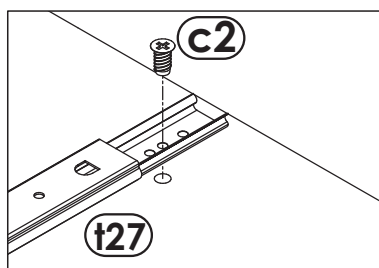
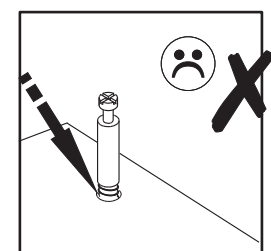
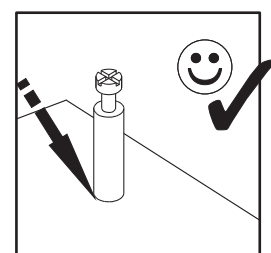
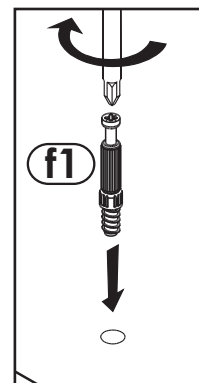
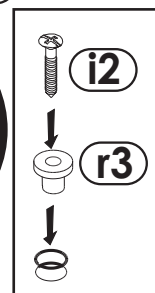
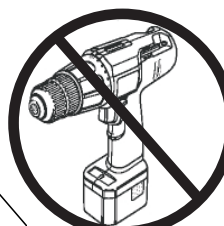
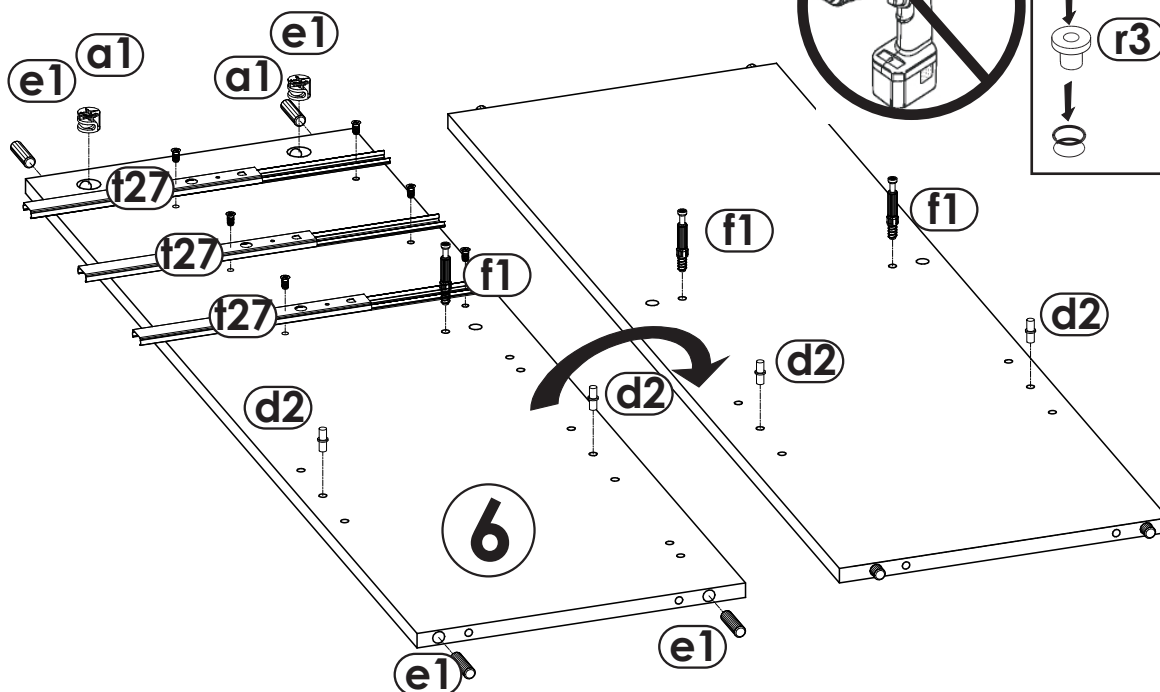
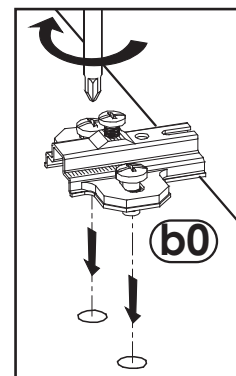
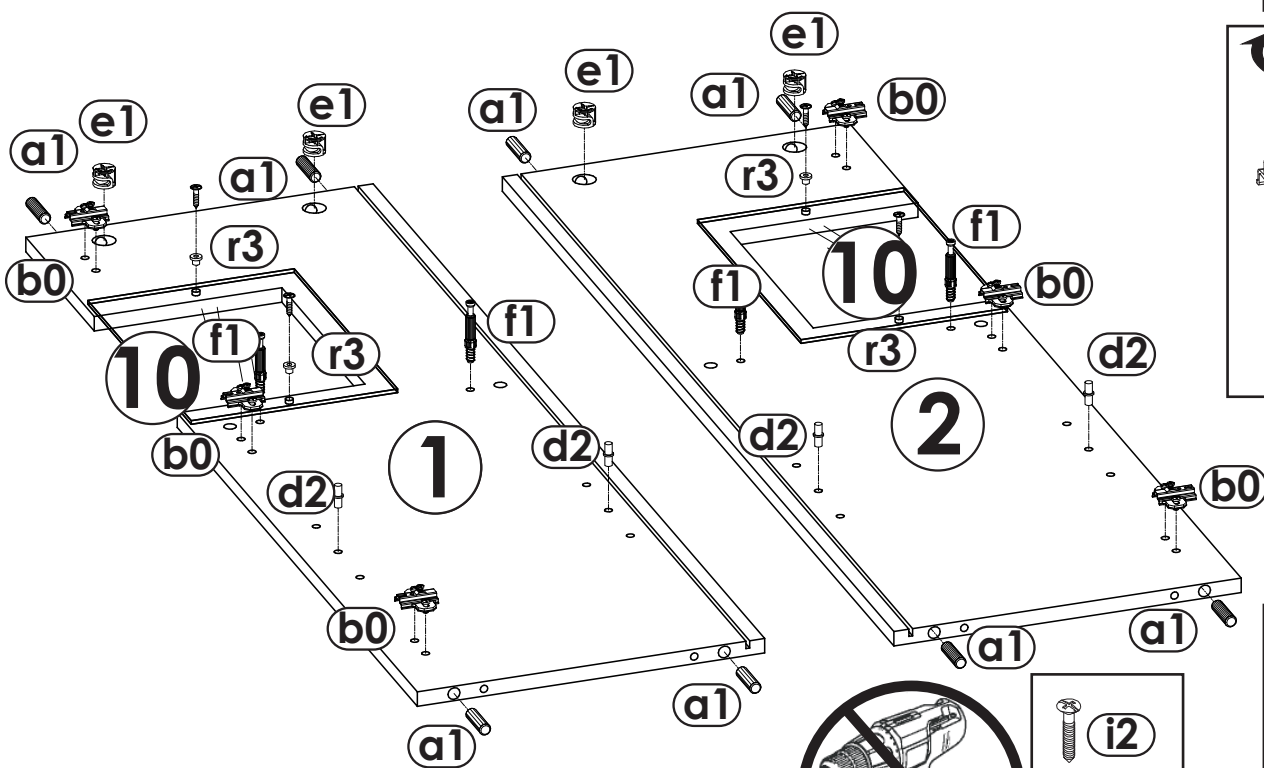
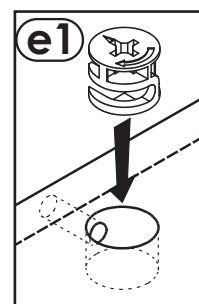
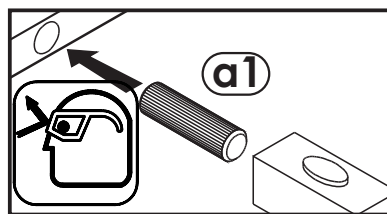
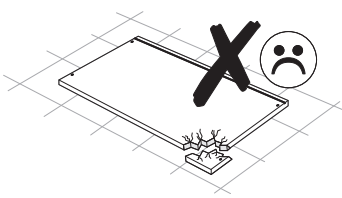
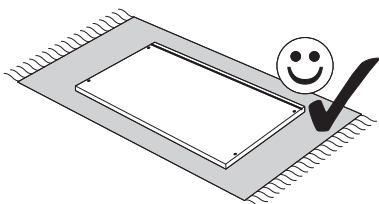

2

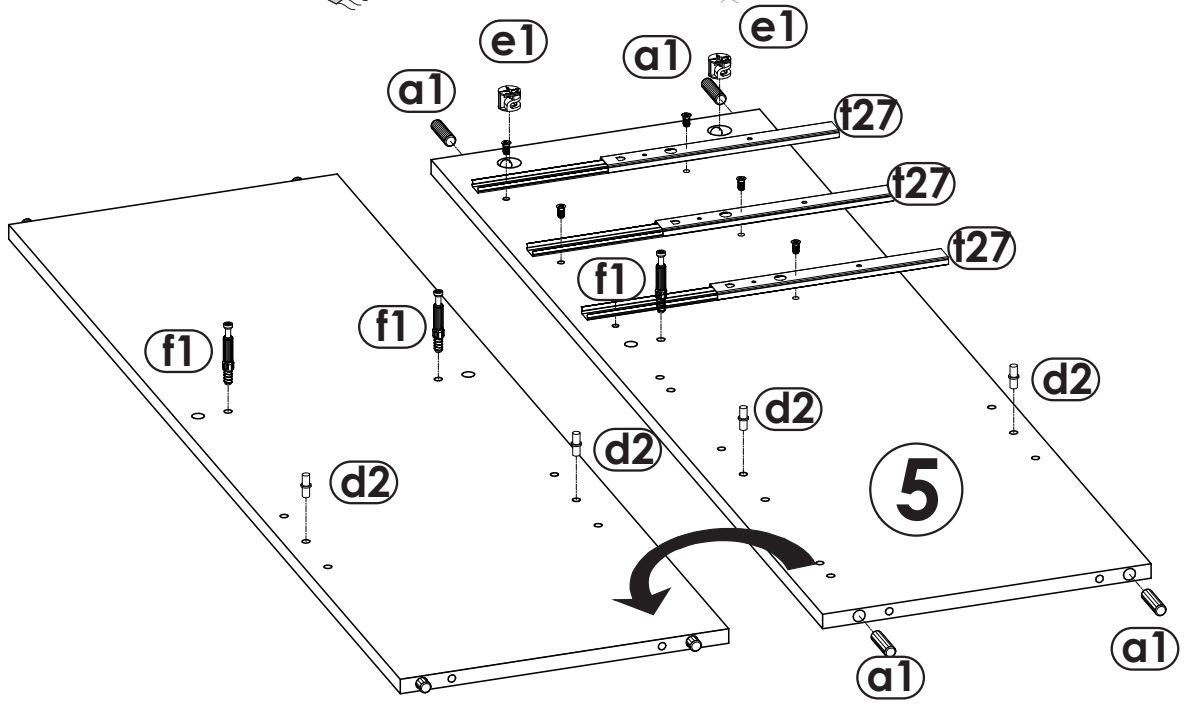
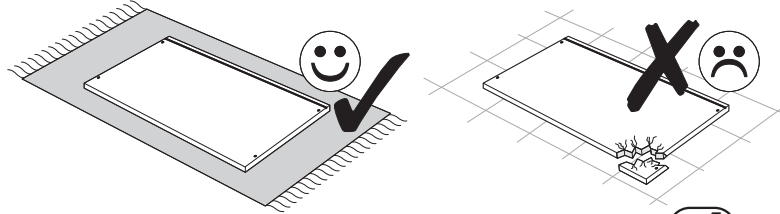

3

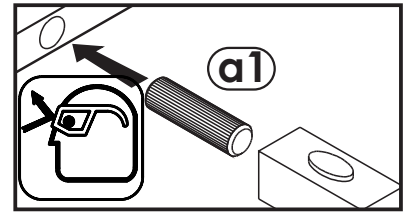
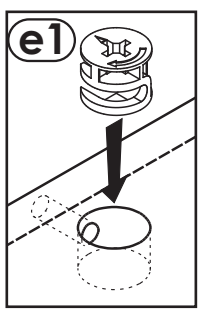
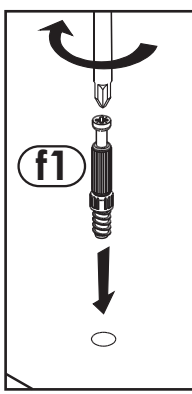
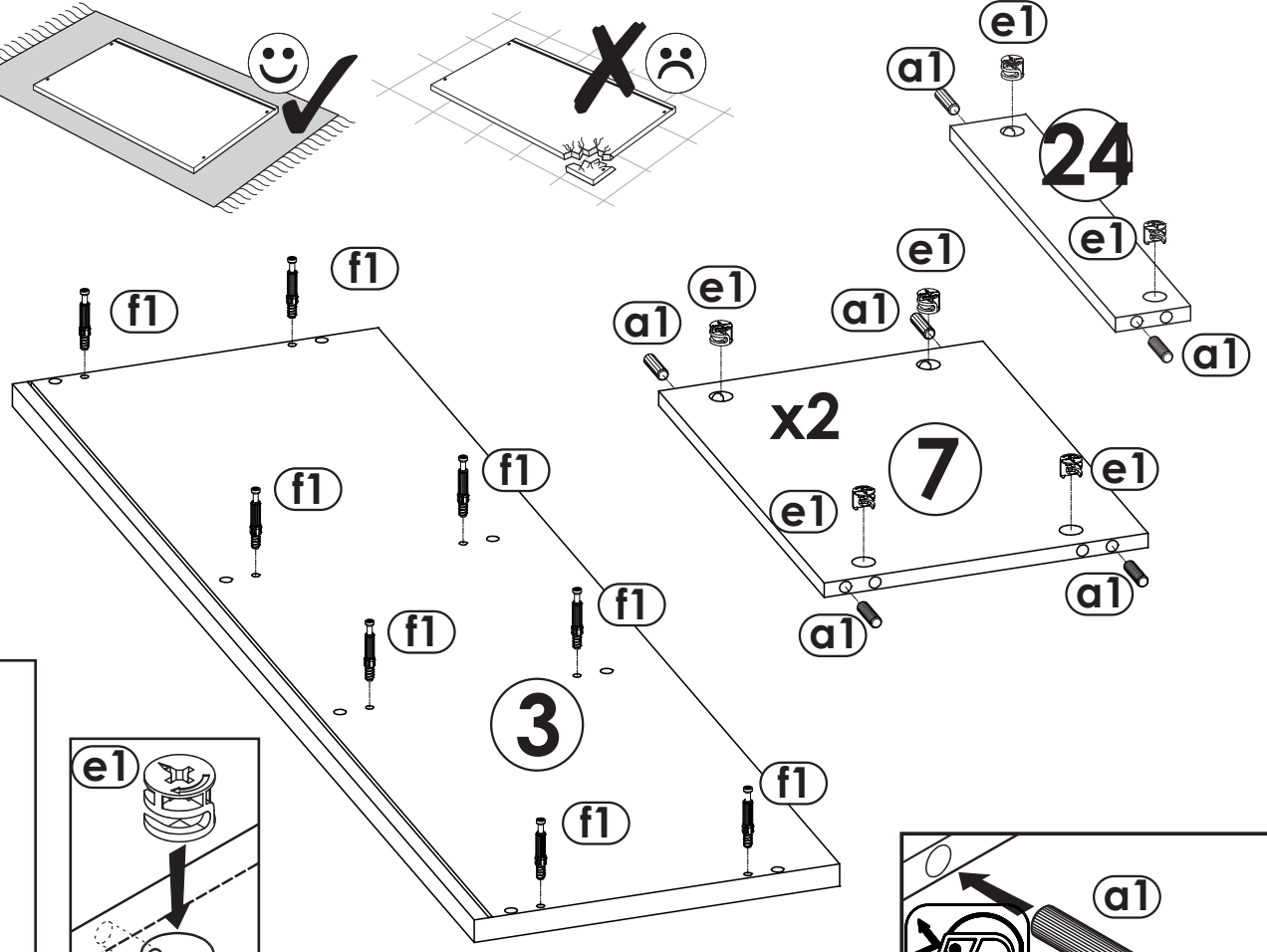
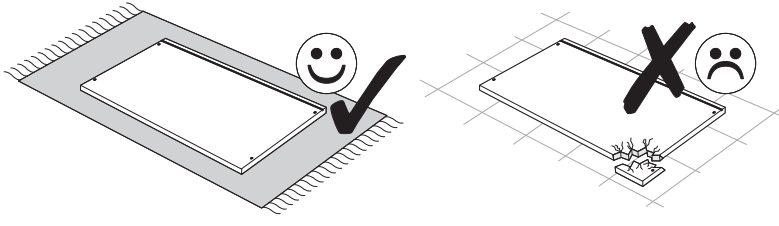

4
▼

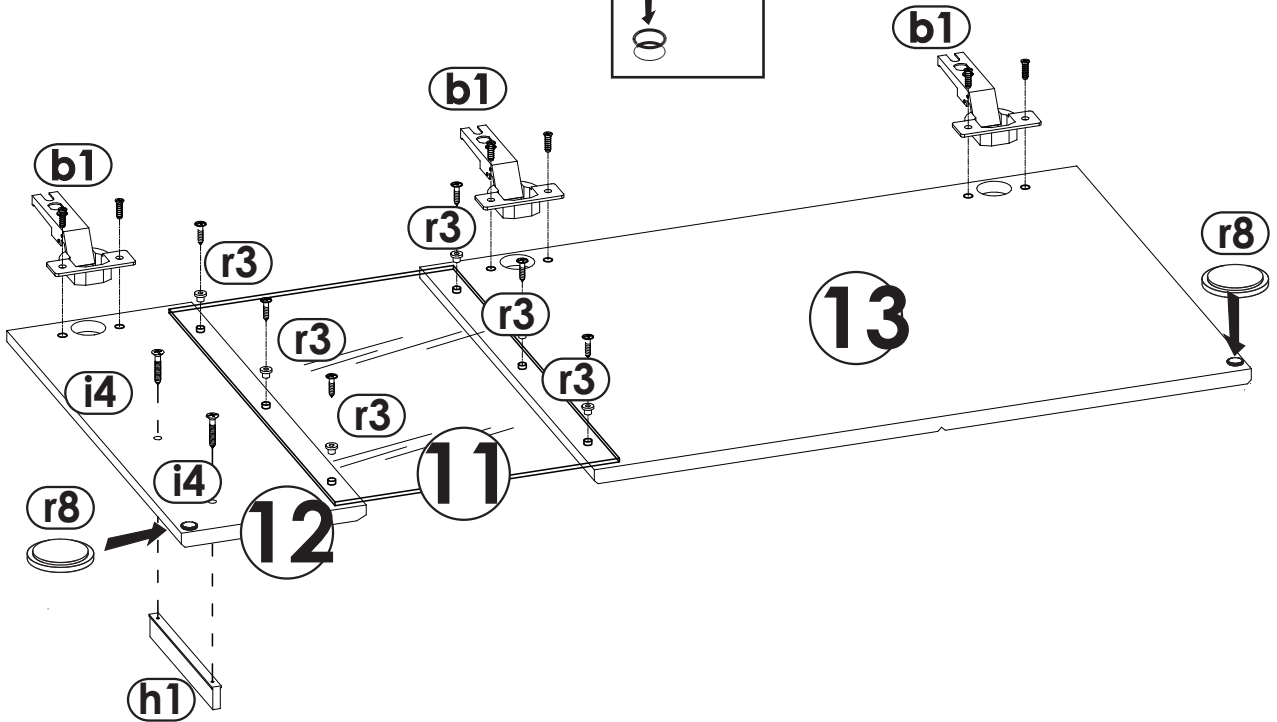
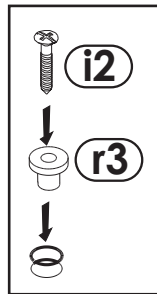
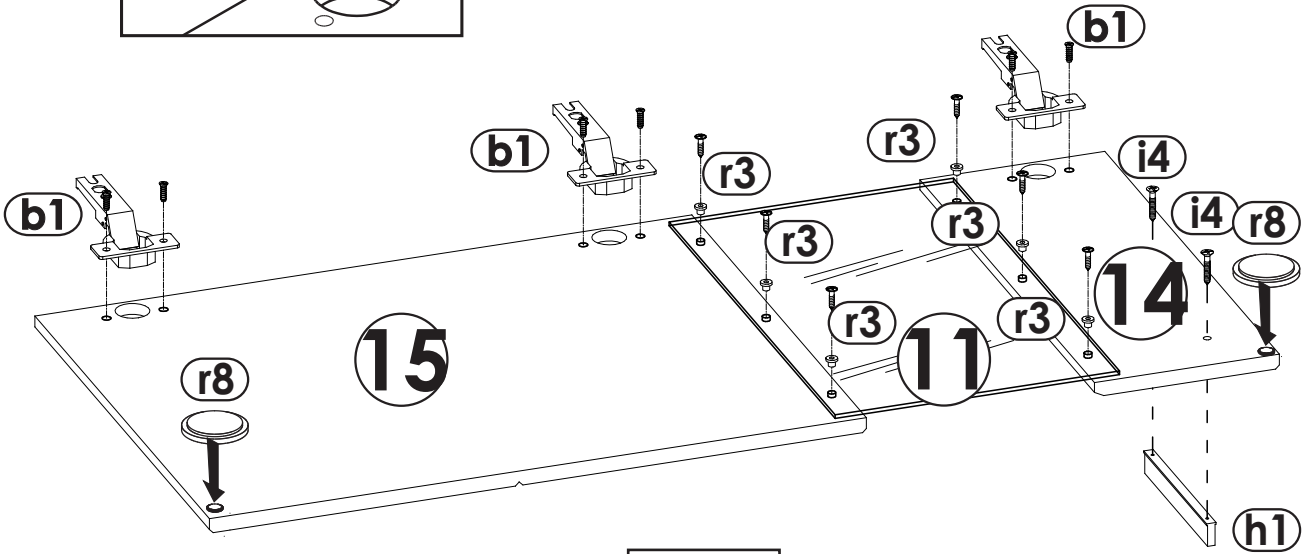
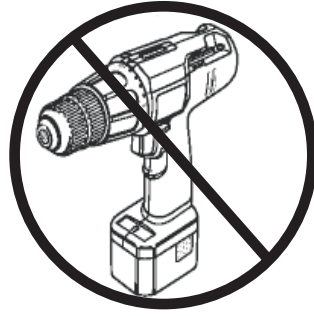
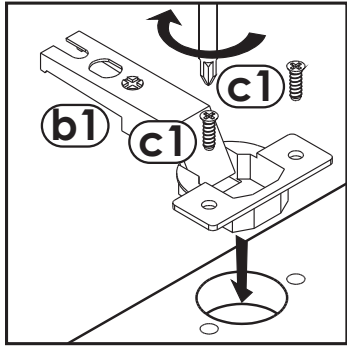

5

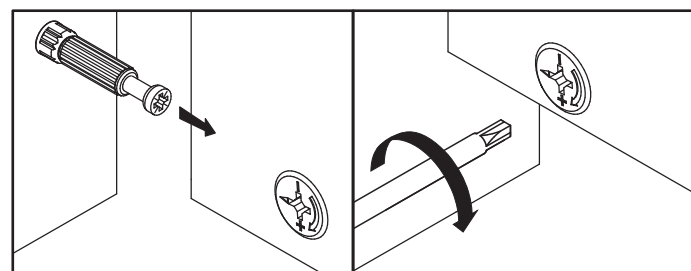
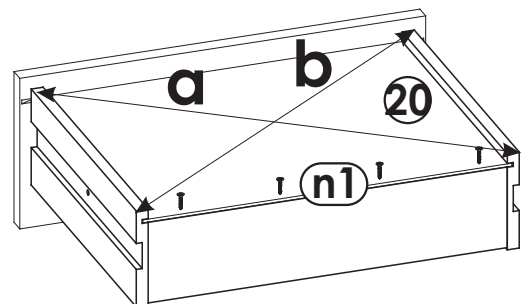
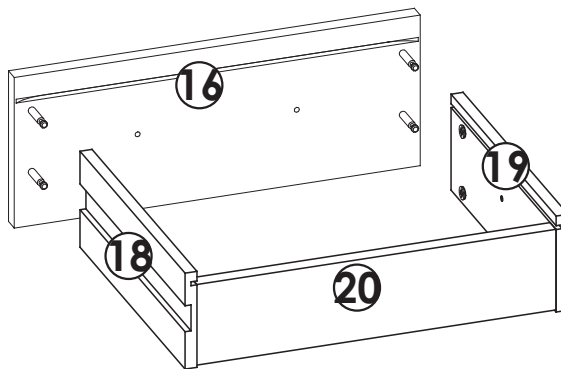
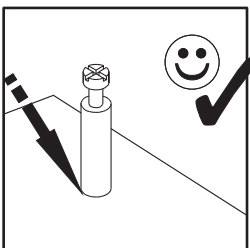
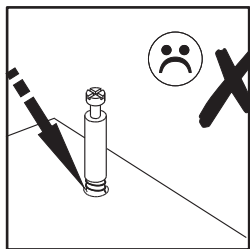
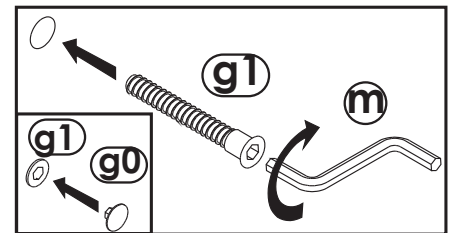
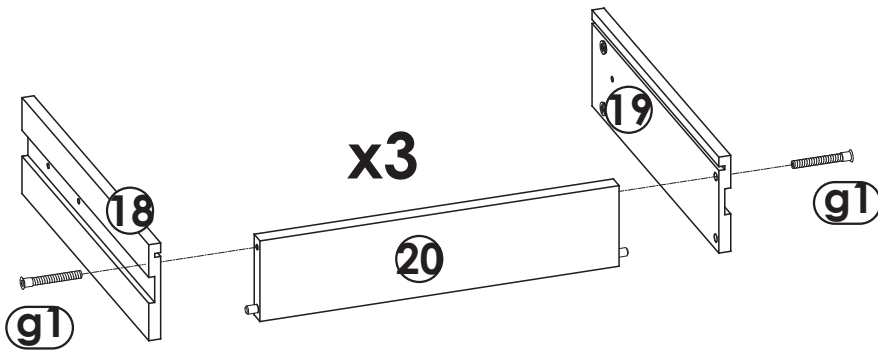
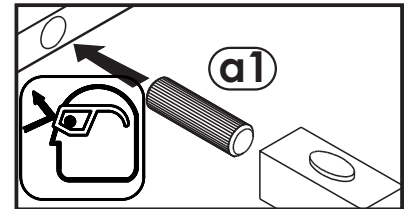
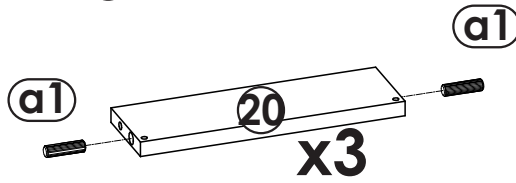
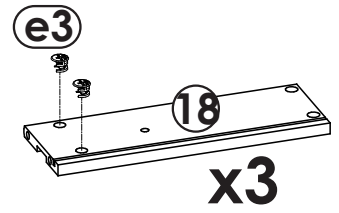
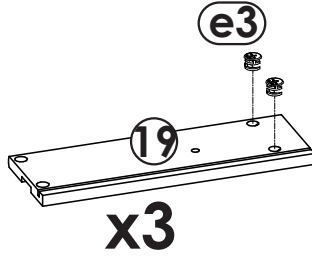
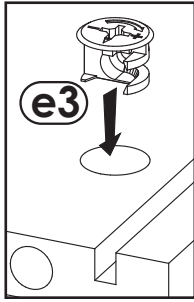
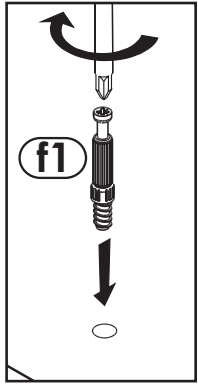
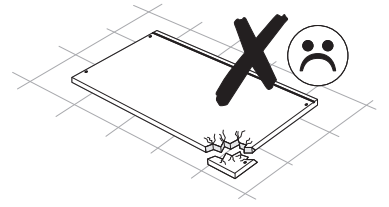
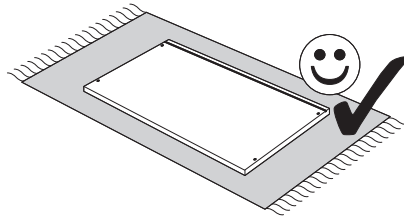
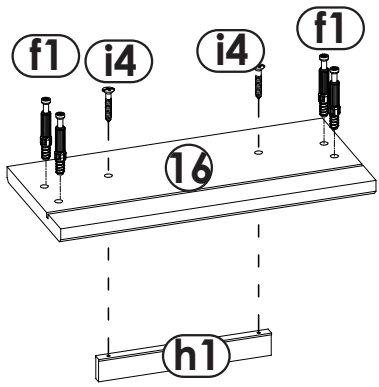

a=b

6

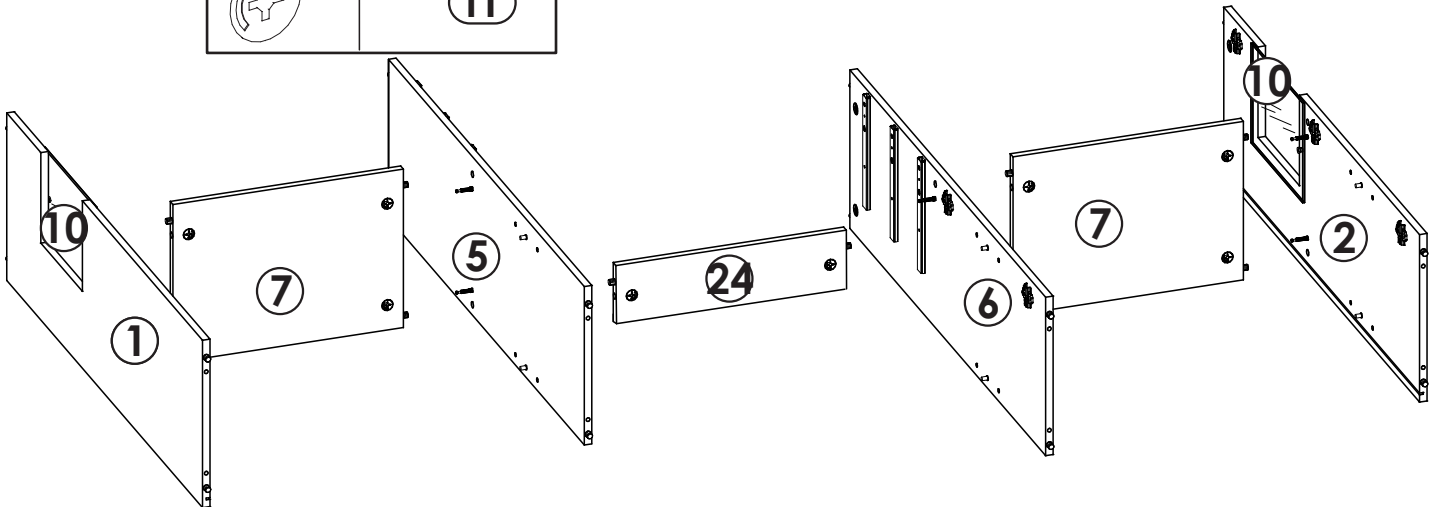
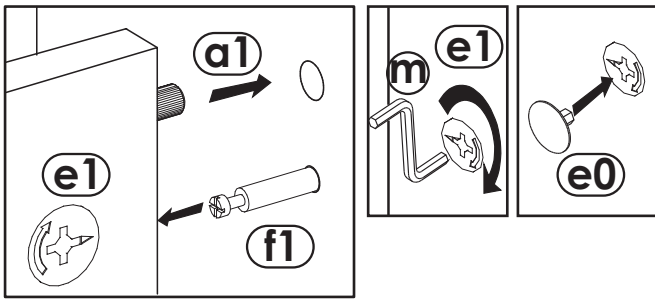

7

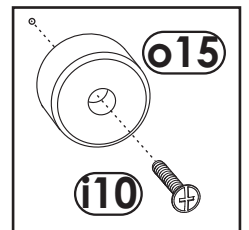
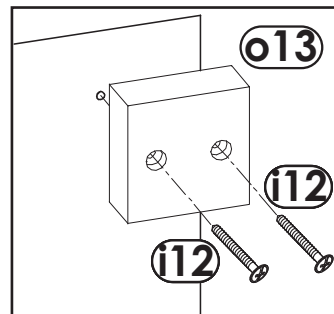
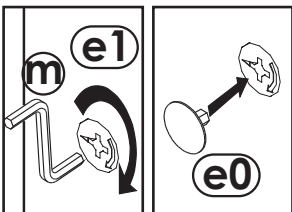
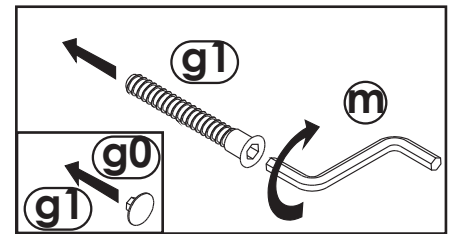
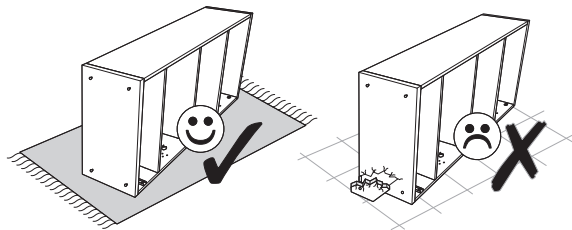
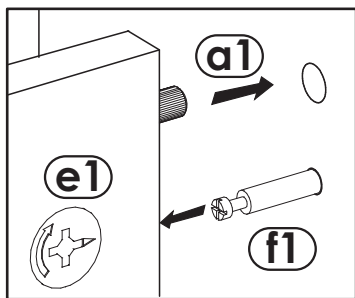
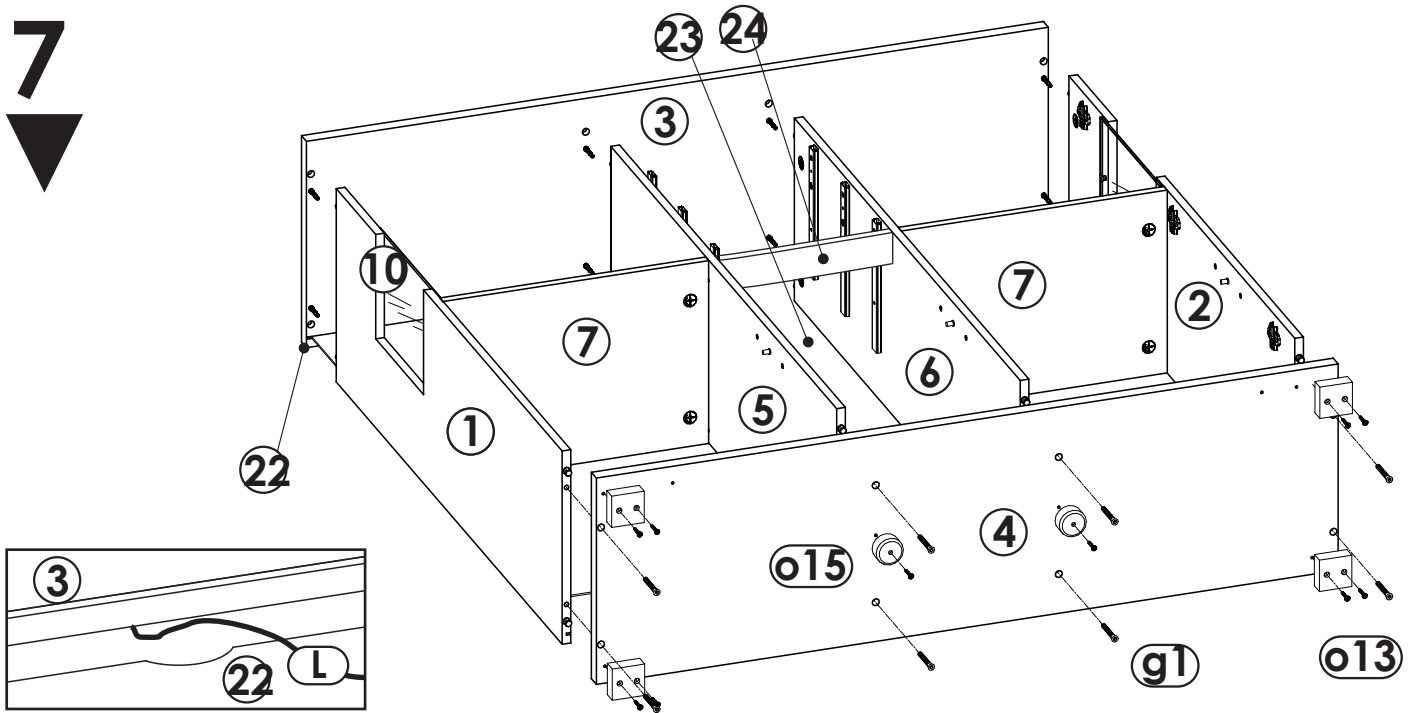

8

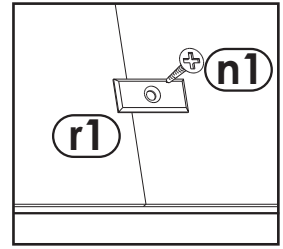
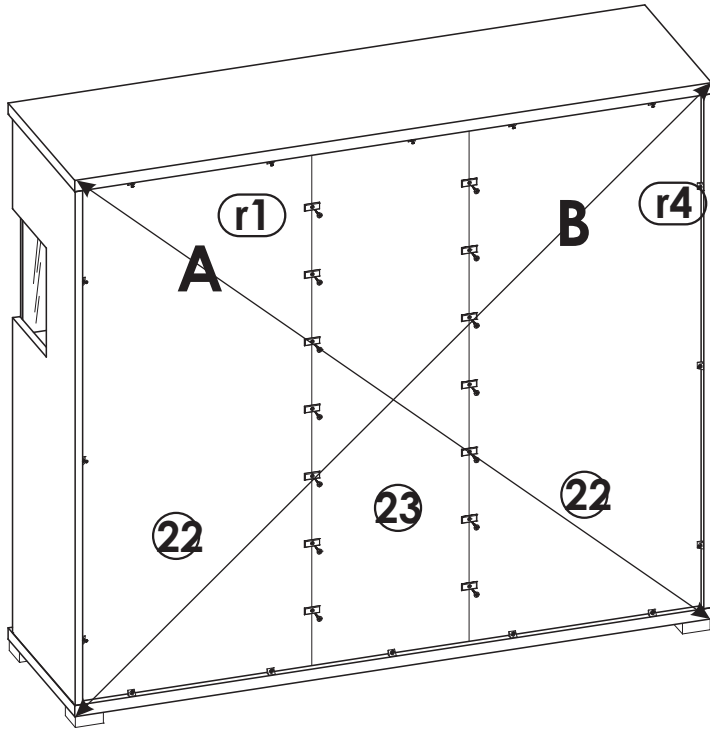

A=B

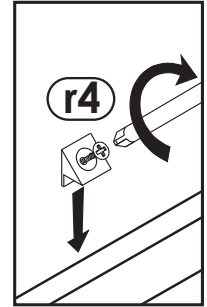

9

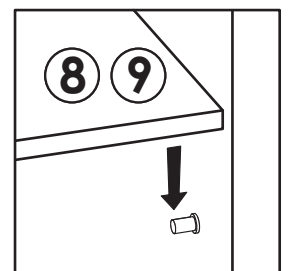
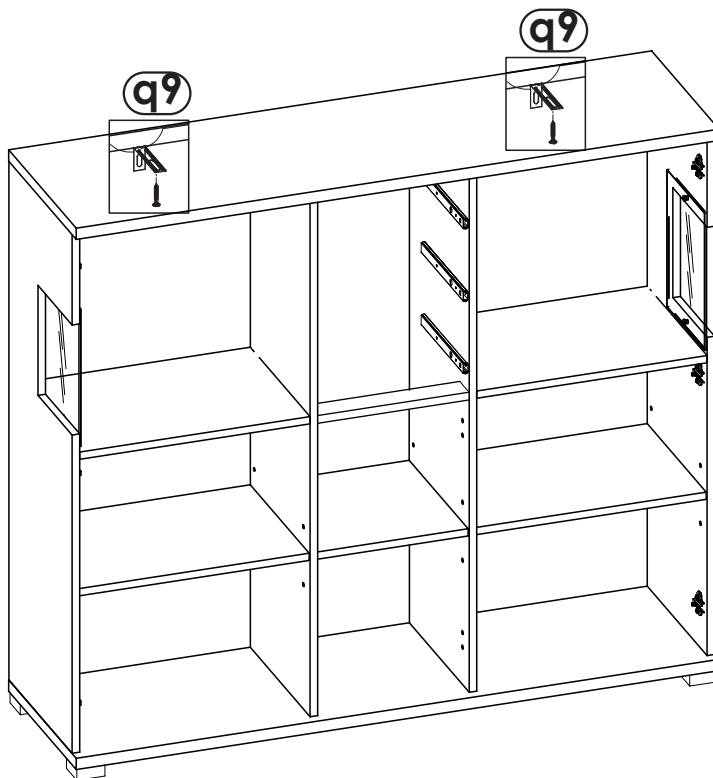
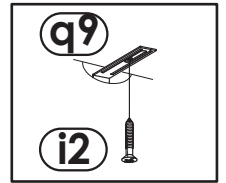
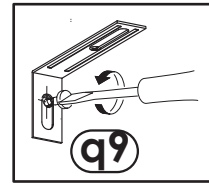
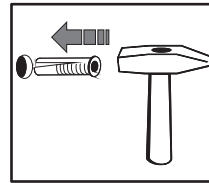
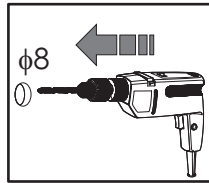
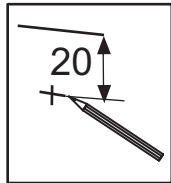
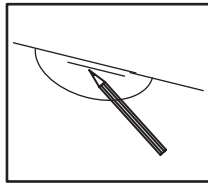

10R

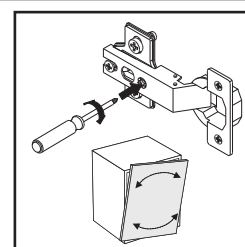
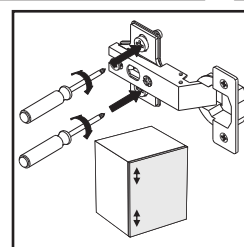
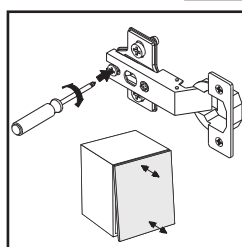
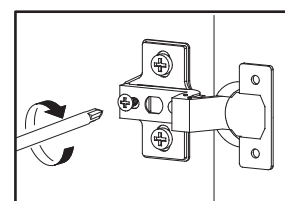
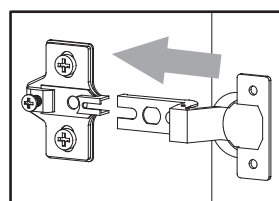
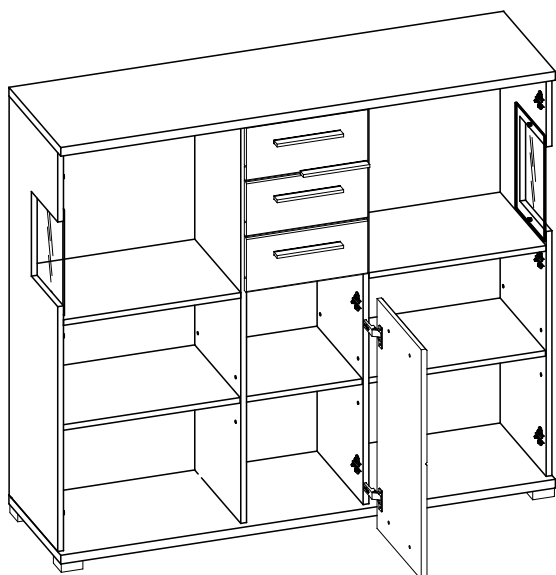
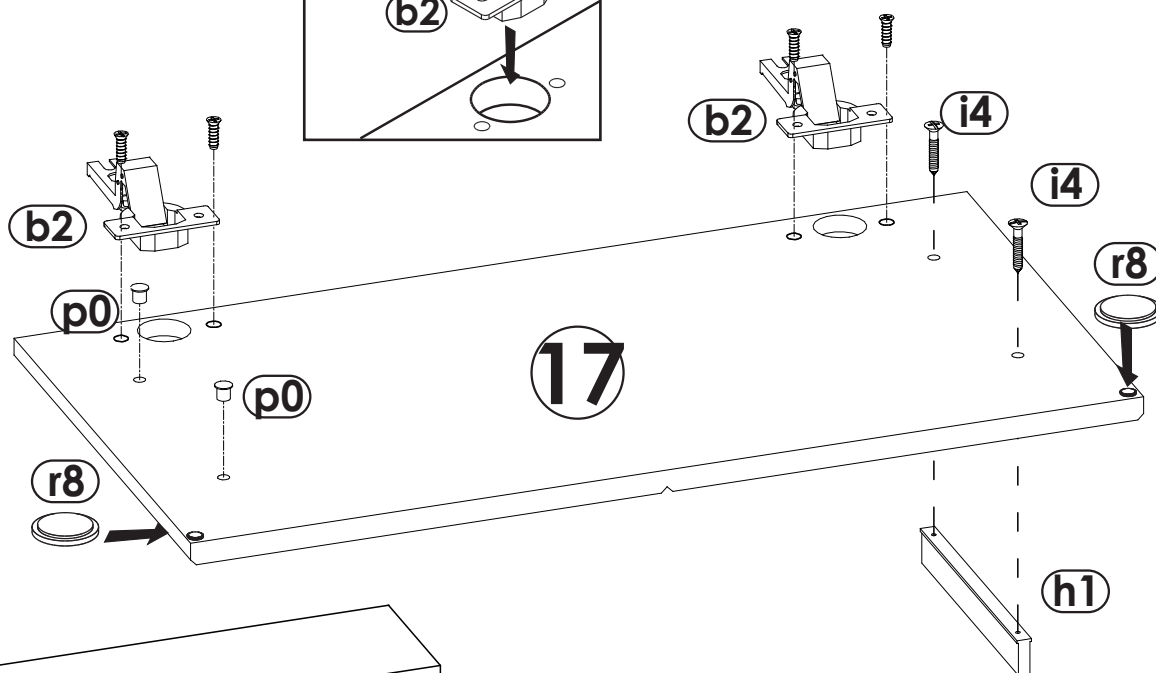
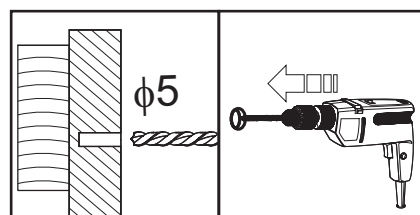
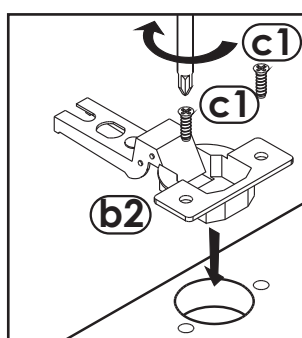
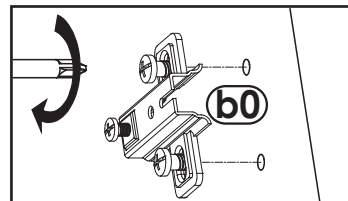
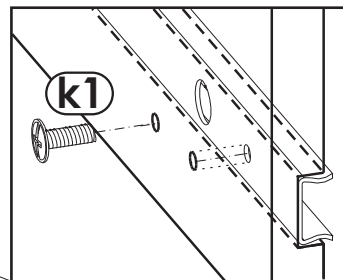
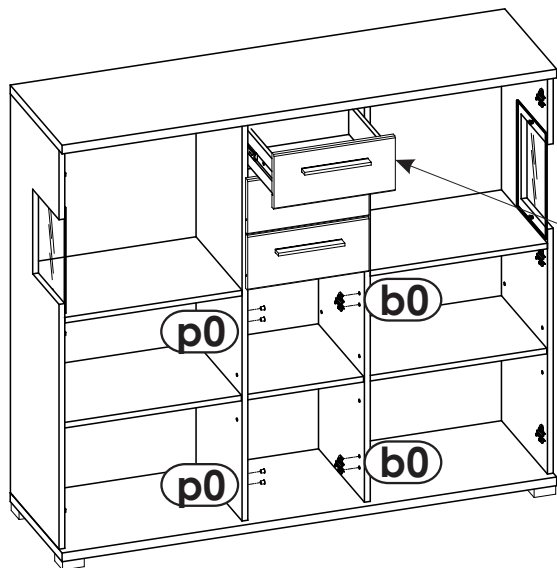

10L

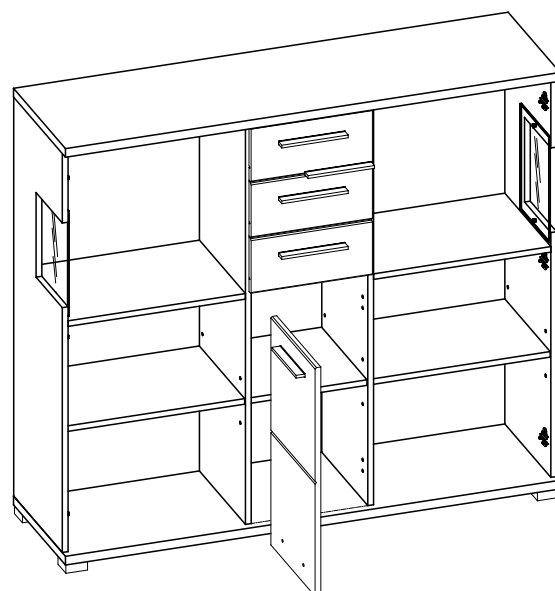
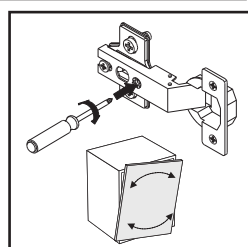
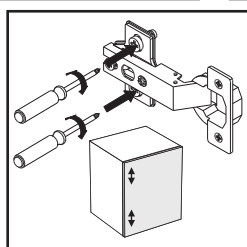
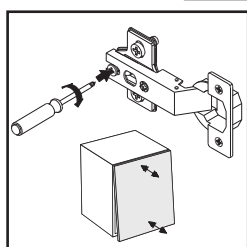
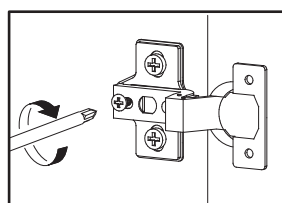
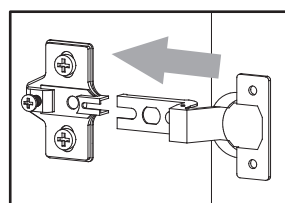
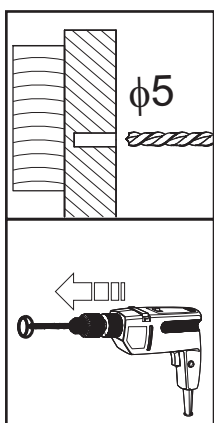
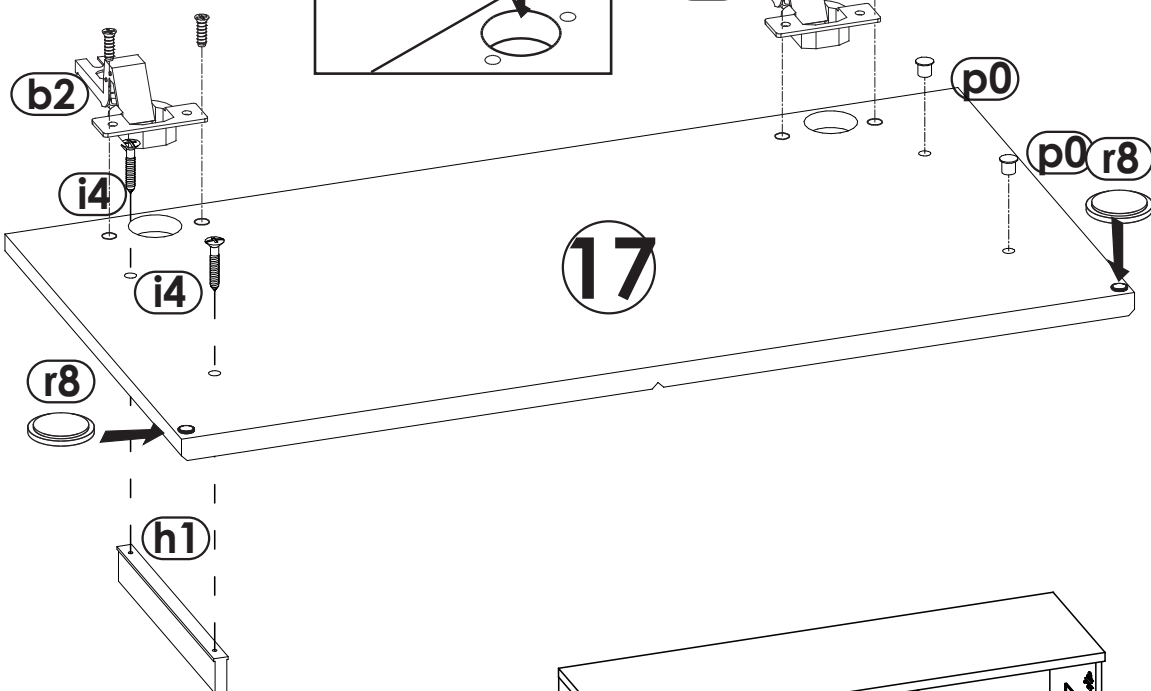
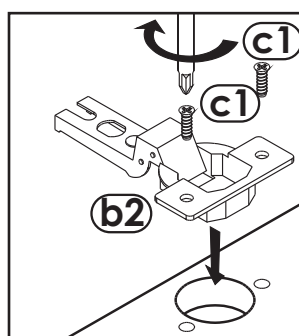
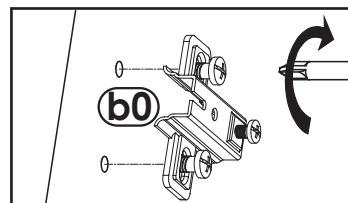
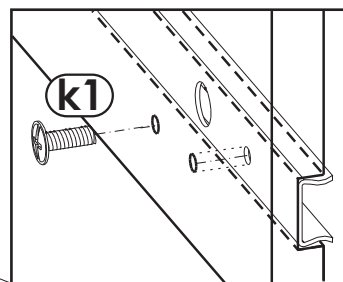
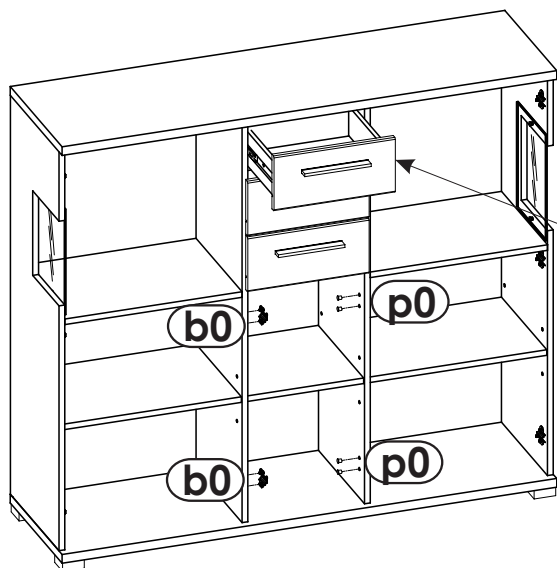

11
↓

