

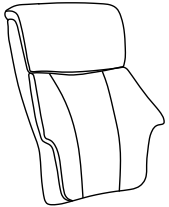





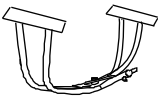
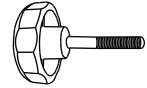
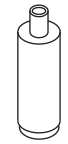

FM-476

 1	 2	 3	 4	
 5	 6	 7	 8	
 9	 10	 11	 12	
 M6*20 8 PCS A	 M8*25 2 PCS B	 M8*50 1 PCS C	 M8*50 2 PCS D	 M6 E

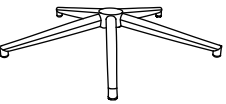
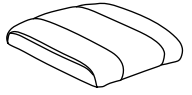
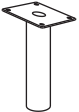

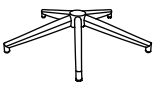
5

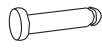
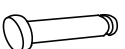
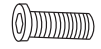
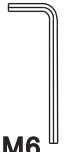
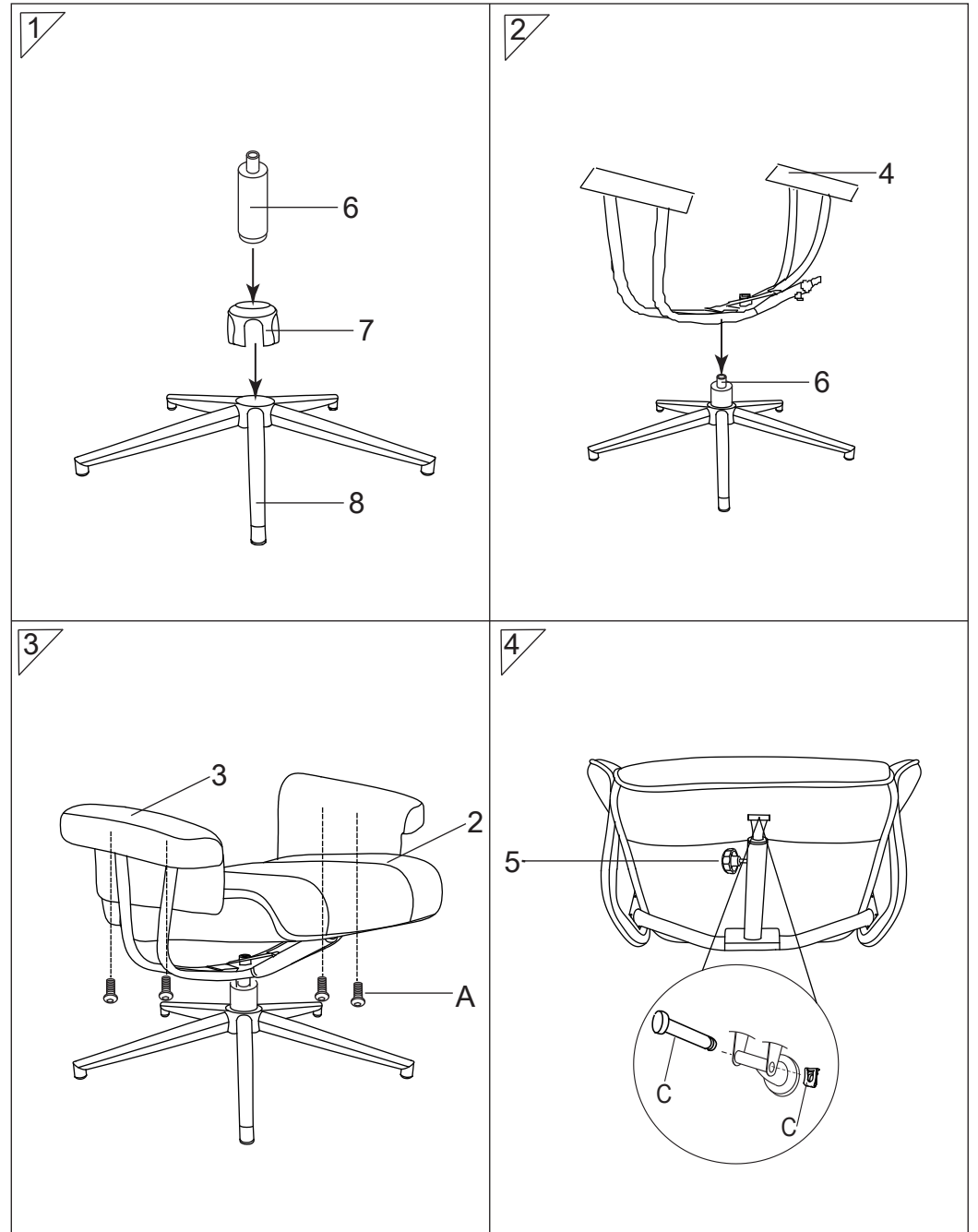

6

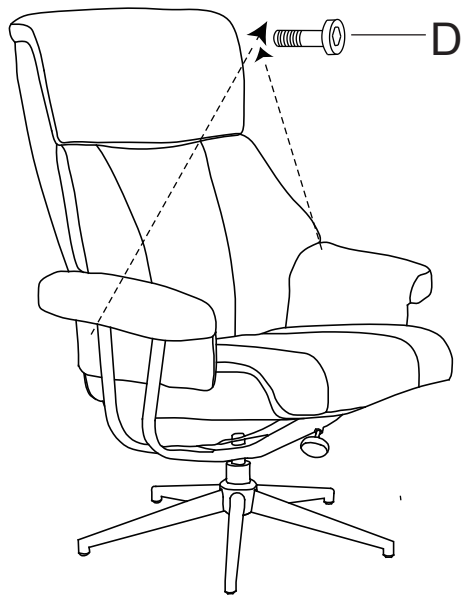

7

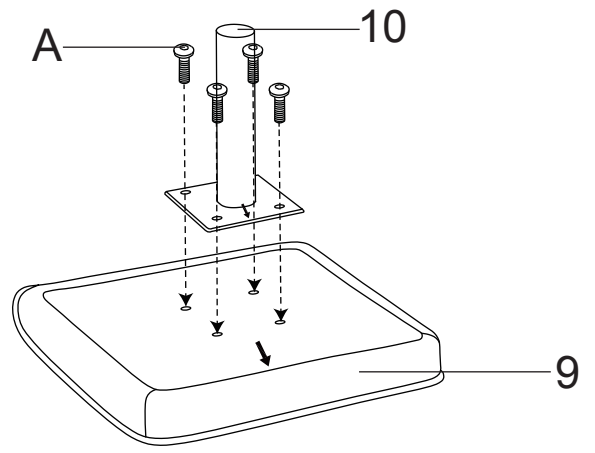

8

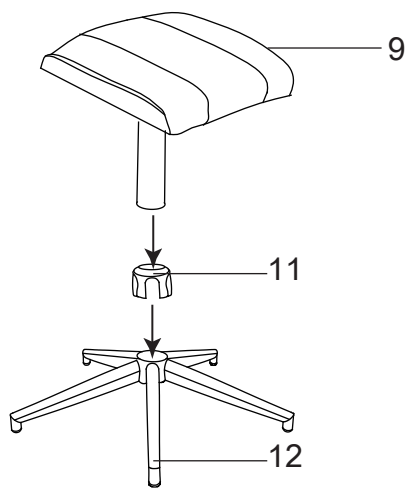

9

