

SCONTO **N Á B Y T O K**

MONTÁŽNY NÁVOD

Posteľ typu box

klasické predné nohy

www.sconto.sk

ČASTI POSTELE

SO STREDOVOU LATKOU

140x200
160x200
180x200
200x200

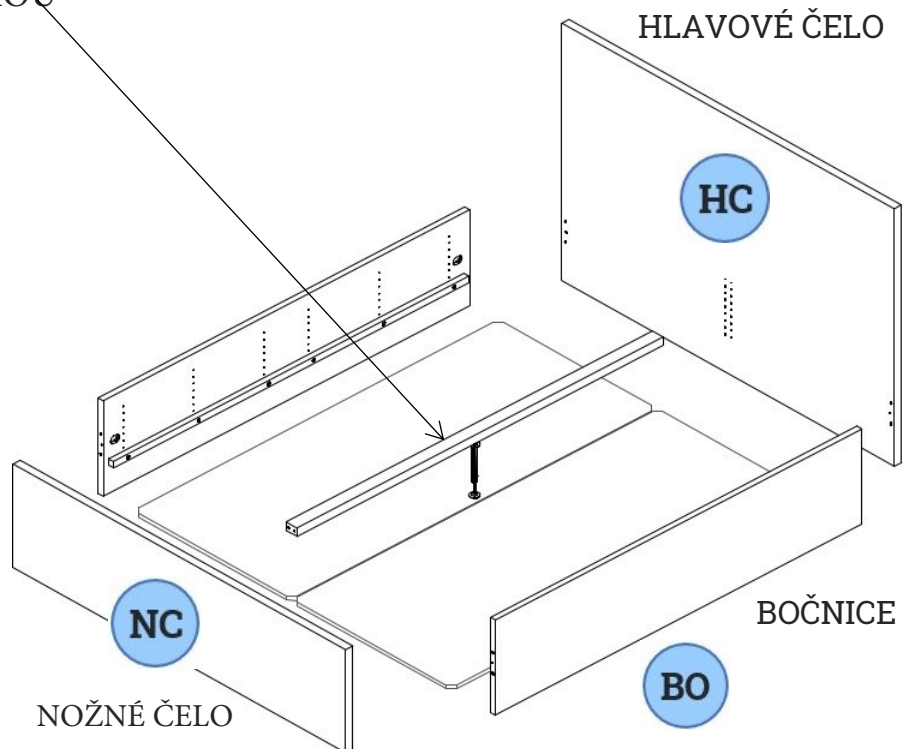

BEZ STREDOVEJ LATKY

80x200
90x200
90x200
100x200
110x200
120x200
130x200

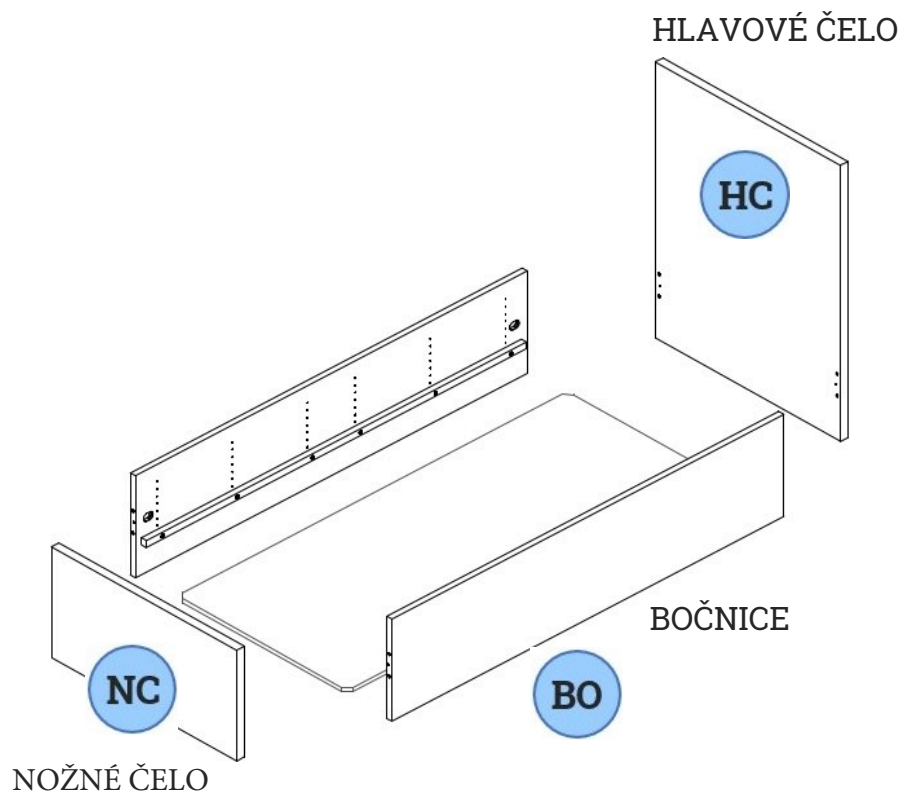

LATKY DO BOČNÍC

LB

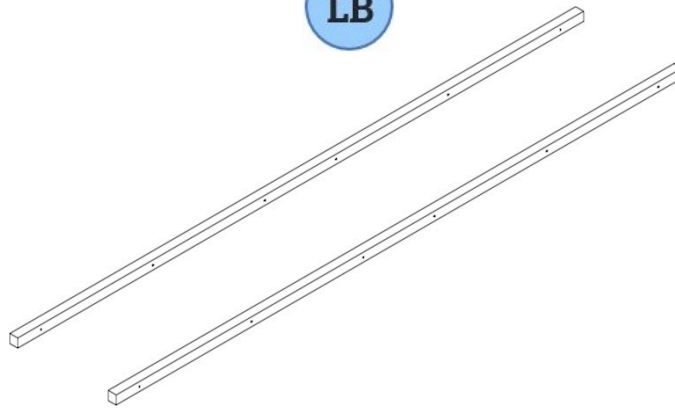

STREDNÁ LATKA

SL

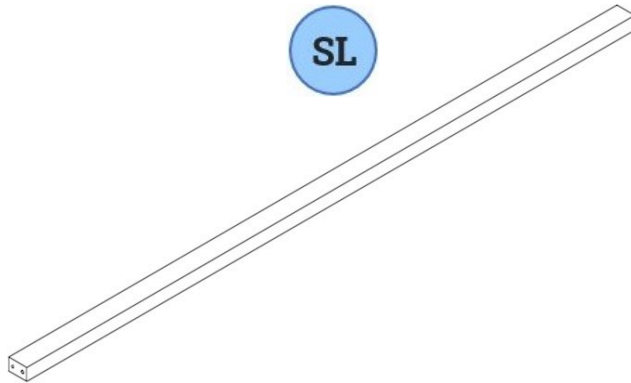

DNO ÚLOŽNÉHO PRIESTORU

DUP

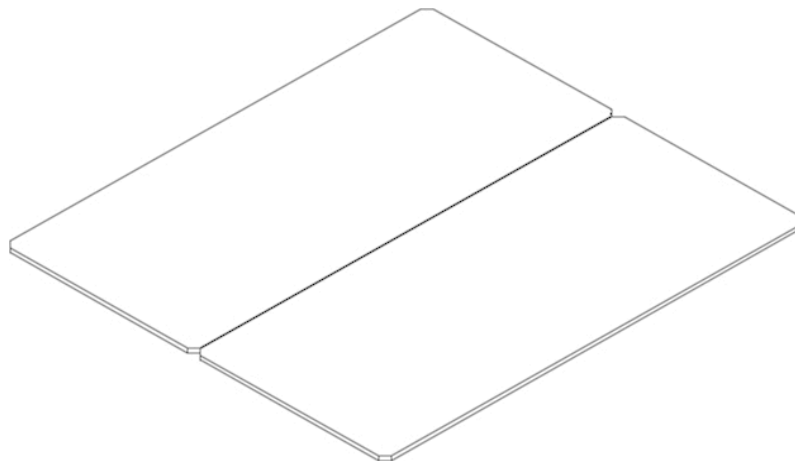

Obrázky uvedené nižšie sú ilustračné, dizajn vašej postele sa môže líšiť.

PRÍKLAD BOČNICE

BO

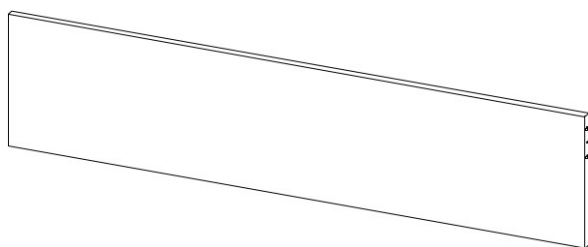

Pohľadová časť

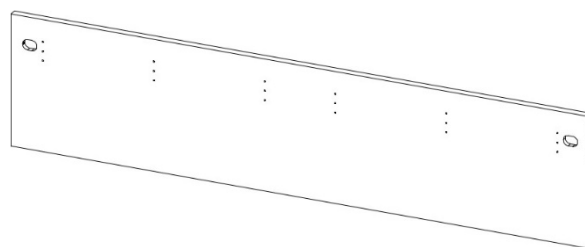

Vnútoraná časť

PRÍKLAD NOŽNÉHO ČELA

NC

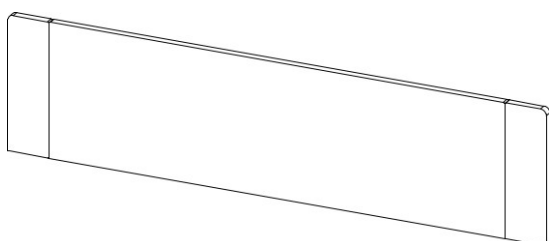

Pohľadová

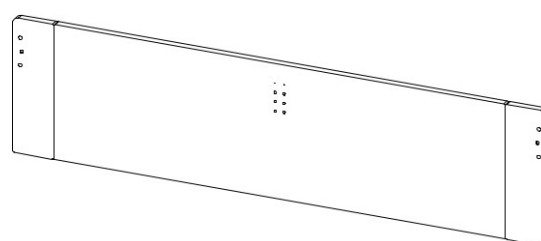







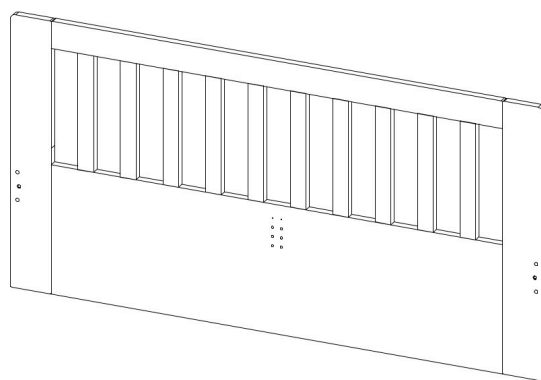
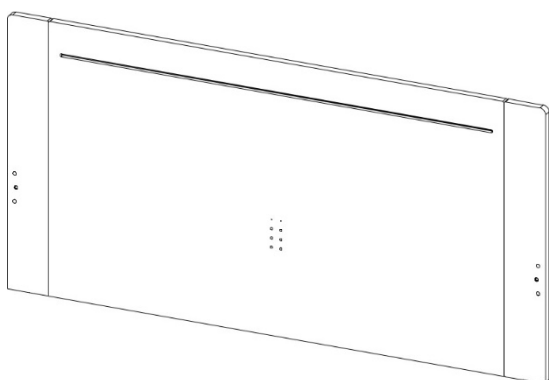

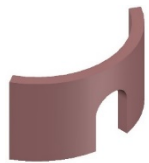

Vnútoraná časť

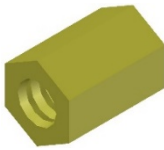
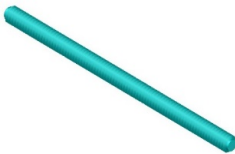
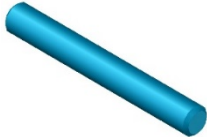
PRÍKLAD HLAVOVÉHO ČELA

HC

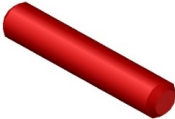
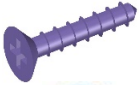

SÚPIS KOVANIA

 1 4 ks	 2 4 ks	 3 4 ks	 4 4 ks
 5 Ø 8x40 4 ks	 6 TORX 7x45 12 ks	 7 2 ks	 8 1 ks
 9 Ø 12 8x24	 10 4x20 4 ks	 11 4x30 4 ks	 12 KLÚČ TORX 1 ks
 13 1 ks			

ZOSTAVENIE POSTELE

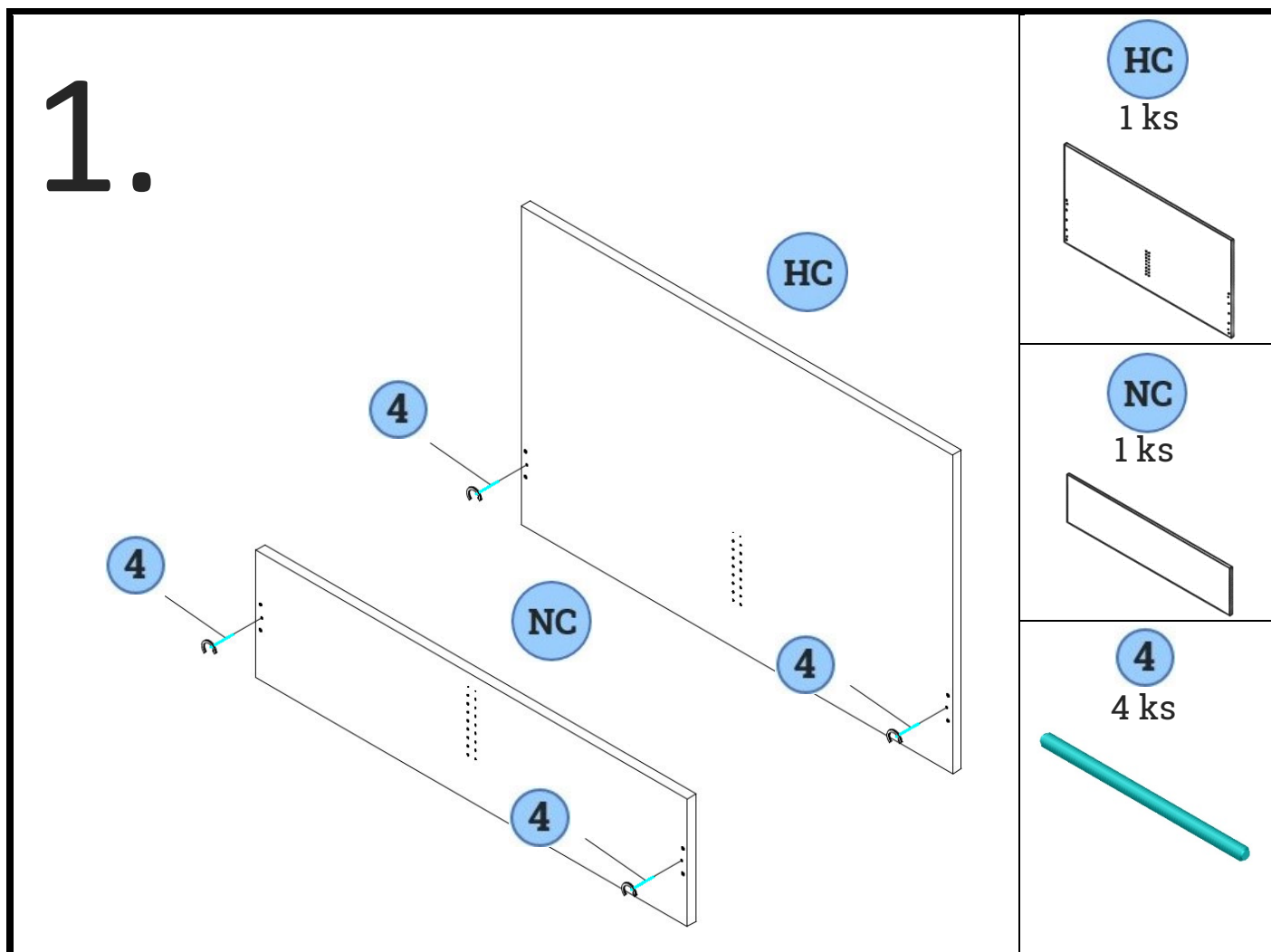

2.

Diagram showing two slats (BO) being attached to a base with red pins (9). The slats are labeled BO and the pins are labeled 9.

<p>BO 2 ks</p>
<p>9 8-26 ks</p>

3.

Pokiaľ máte posteľ šírky 90-130 cm, tento krok preskočte.

Diagram showing a slat (5) being attached to a base with a green pin (8) and a green sleeve (SL). The slat is labeled 5, the pin is labeled 8, and the sleeve is labeled SL.

POUŽITIE NADSTAVCA NA NOHU NA ZÁKLADE VÝŠKOVÉHO UMIESTNENIA LATIEK

<p>SL 1 ks</p>
<p>5 4 ks</p>
<p>8 1 ks</p>

4.

V tomto kroku dobre zväzíte, v akej výške bude umiestnená stredná latka (pozri schému výšky latiek nižšie na tejto strane). V prípade postele šírky 90-130 cm krok umiestnenia strednej latky preskočíte.

Schéma výšky latiek

Latky do bočnic a strednú latku môžete pripevniť do niekoľkých pozícií. Výšková pozícia latiek ovplyvňuje tieto dve veci:

- 1) Výslednú výšku lôžnej plochy (pozor, berte do úvahy aj výšku roštu).
- 2) Koľko cm matracu bude zapusteného v ráme postele (odporúčame minimálne 5-8 cm).

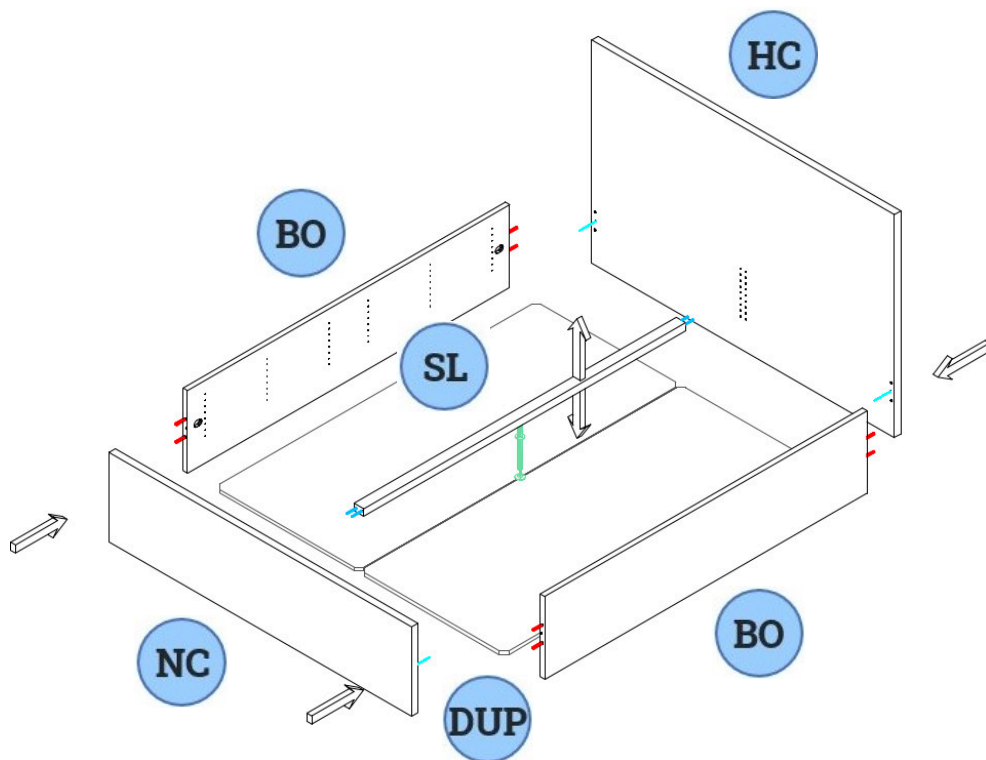
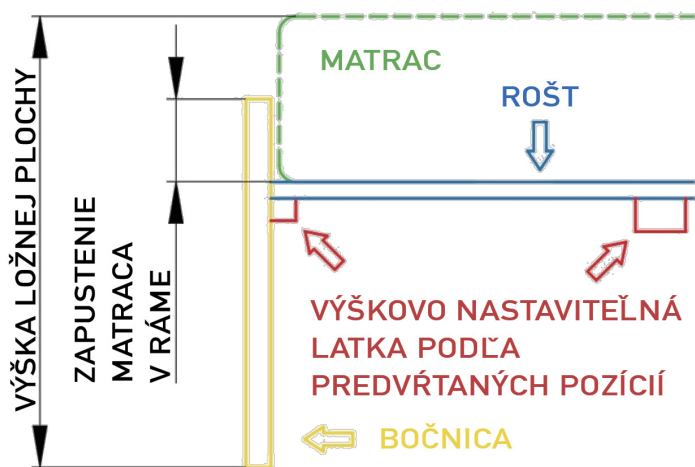

HC

1 ks

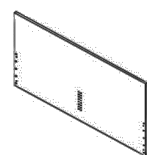

NC

1 ks

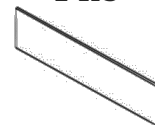

BO

2 ks



SL

1 ks



DUP

1 ks

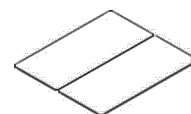

5.

Pred stiahnutím skrutkového spoja starostlivo skontrolujte, že k sebe dielce bočnice a čela postele dokonale doliehajú. V prípade nutnosti použite gumovú paličku. Až potom je možné skrutkový spoj dotiahnuť.

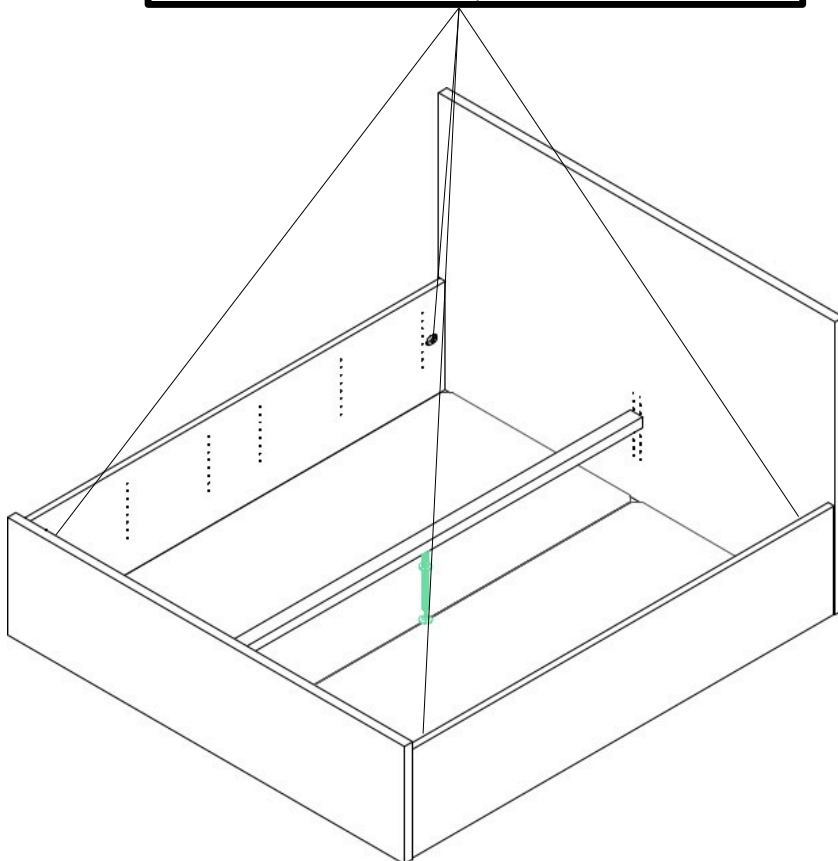
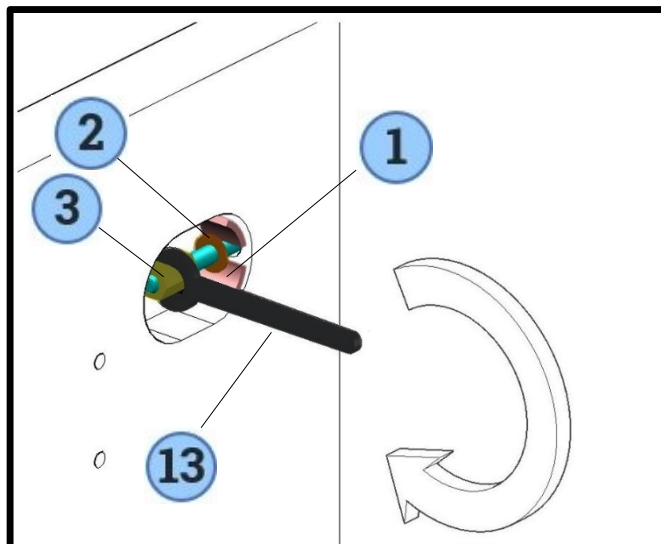

1

4 ks



2

4 ks



3

4 ks

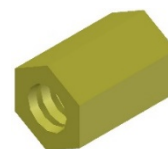

13

1 ks



6.

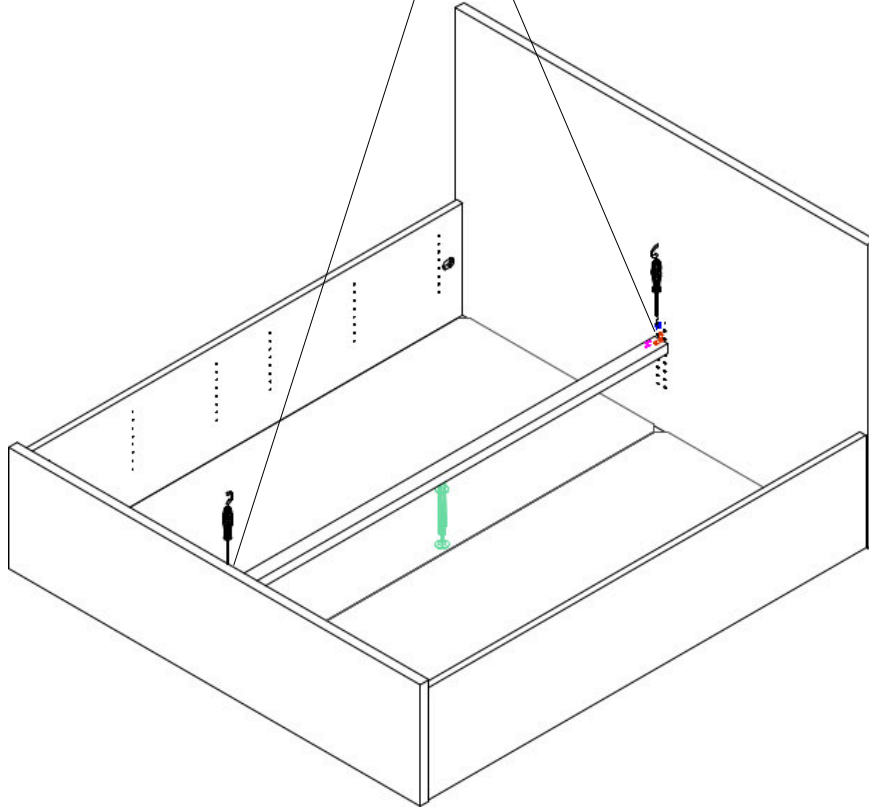
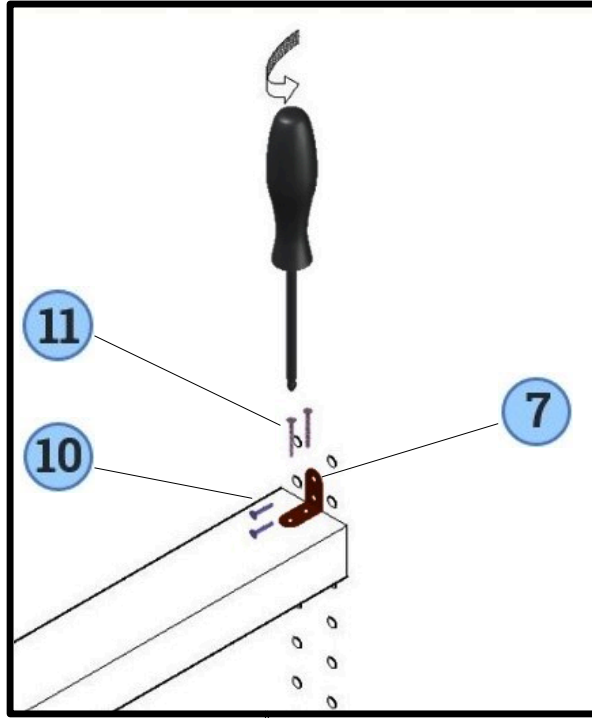

10

4 ks



11

4 ks



7

2 ks

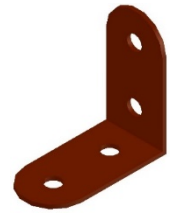

7.

Schéma výšky latiek

Latky do bočnic a strednú latku môžete pripevniť do niekoľkých pozícií.

Výšková pozícia latiek ovplyvňuje tieto dve veci:

- 1) Výslednú výšku ložnej plochy (pozor, berte do úvahy aj výšku roštu).
- 2) Koľko cm matraca bude zapusteného v ráme postele (odporúčame minimálne 5-8 cm).

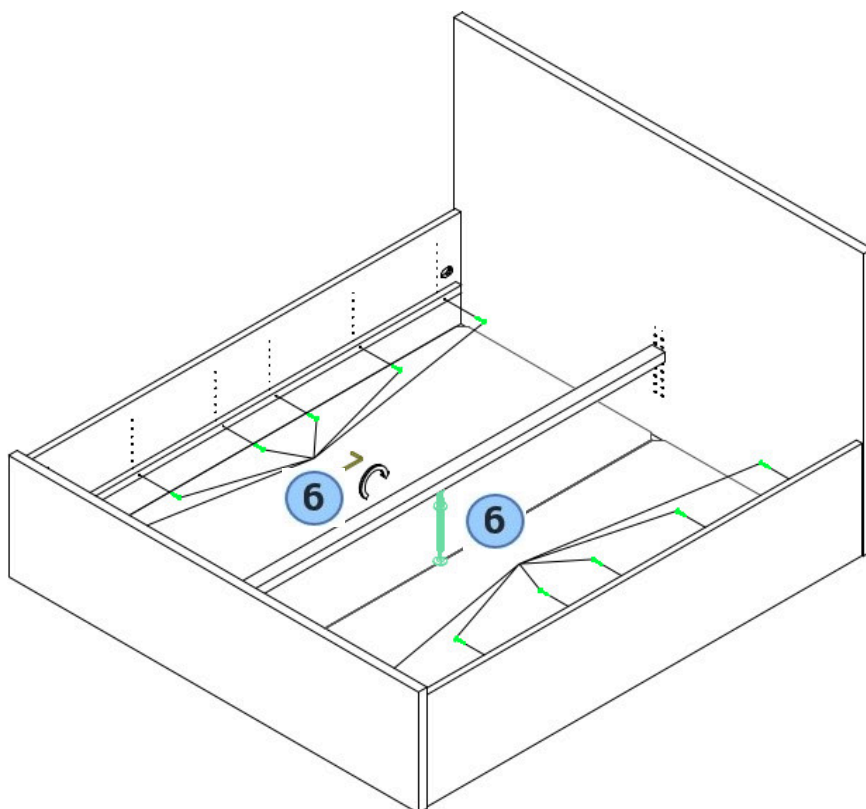
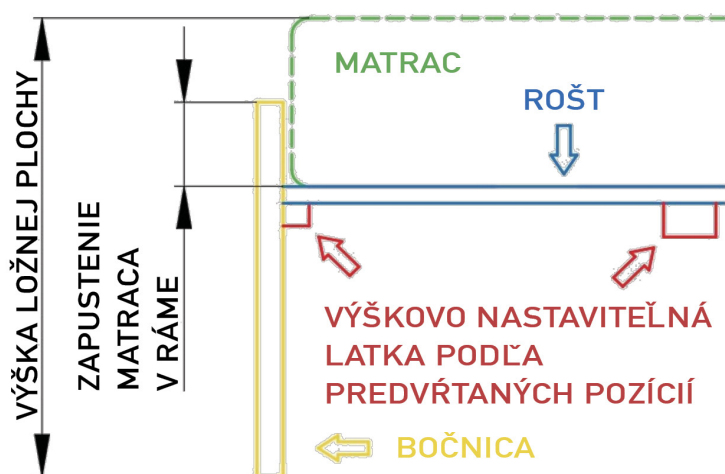

LB

2 ks

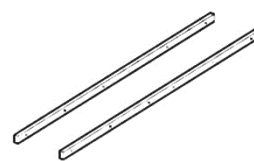

6

TORX
7x45
12 ks



12

KLÚČ
TORX
1 ks

