

# Talia

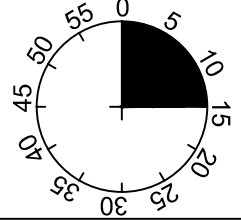
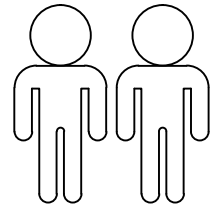
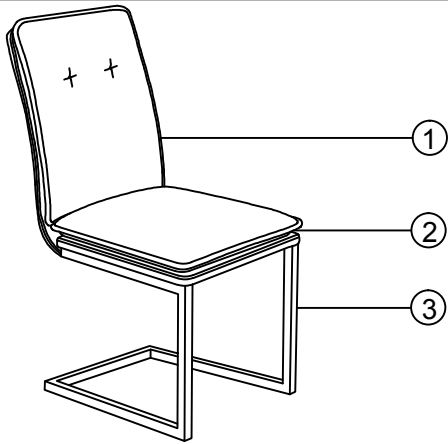

1

2

3

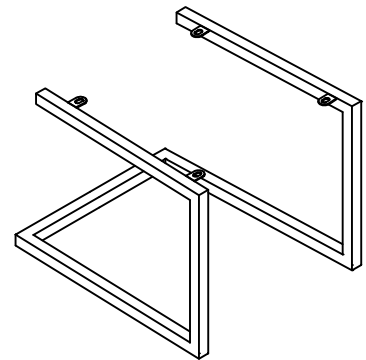
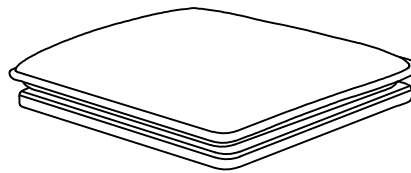
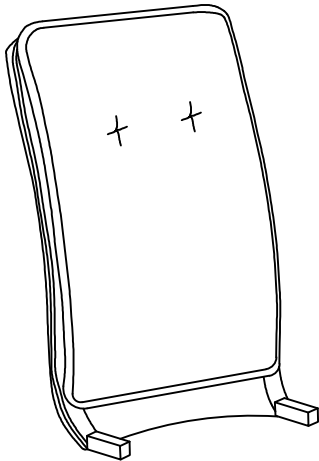

1	1 x	1/2
2	1 x	2/2
3	1 x	2/2

A

M6X20

B

M6X12

C

Ø18xØ6x1.5

D

4MM



4x



4x



4x

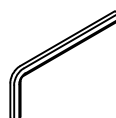

1x

**I.**

**1**

**B** M6x12  
4x

**D** 4MM  
1x

75%

**2**

**A** M6X20  
4x

**C** Ø18xØ6x1.5  
4x

**D** 4MM  
1x

75%

**3**

**D** 4MM  
1x

100%

