

TANGO

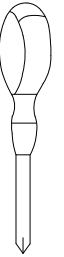

Teil	L	W	H	Pcs	Colli
1	110	153/173/193	16	1x	1/4
2	82	203	38	1x	2/4
3	82	203	38	1x	3/4

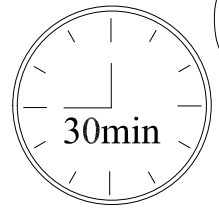
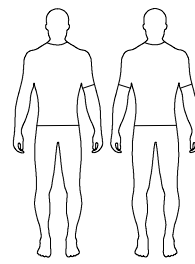
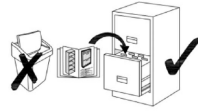
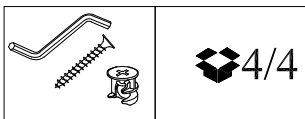
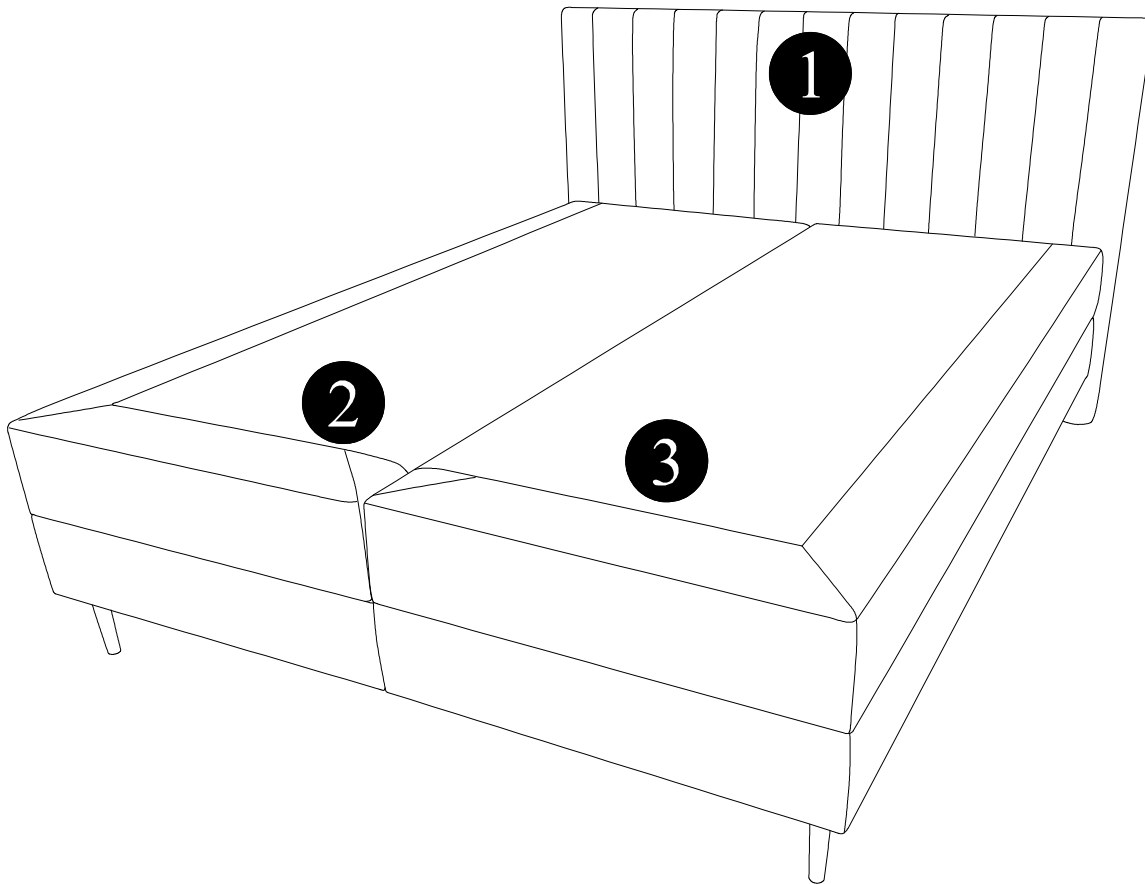

A		H-150	2x	B		H-150	6x	C		6X25	1x	D		H-150	1x	E		M6x80	4x
F		M6	4x																

A	B	C	D
H-150	H-150	6X25	H-150
2x	6x	1x	1x

1

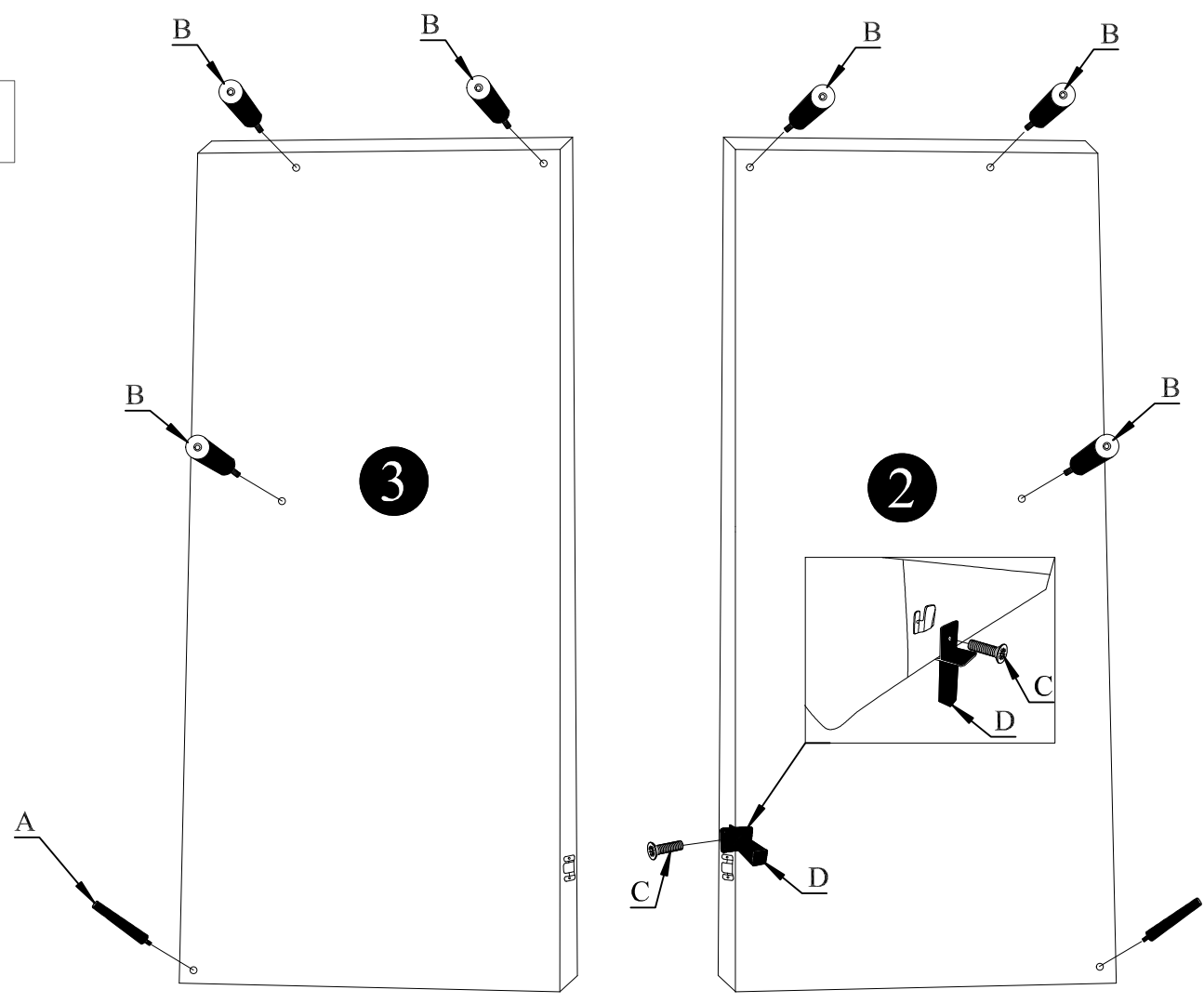

2

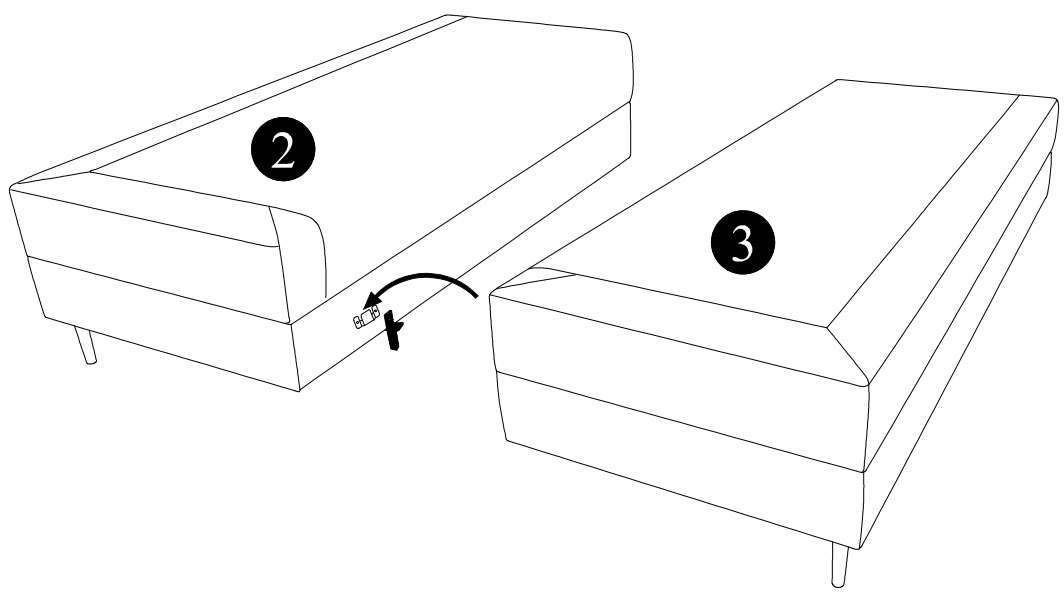

F	E
M6x80	M6
4x	4x

3

