

60 min 

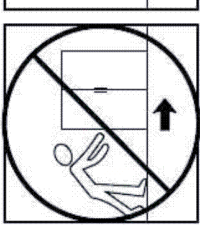

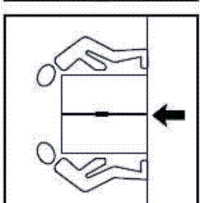

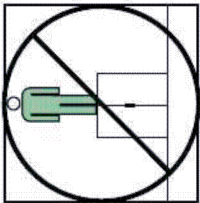
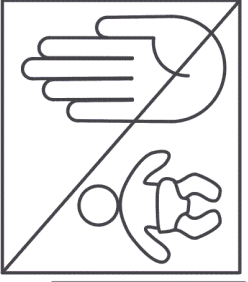
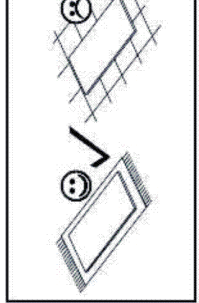
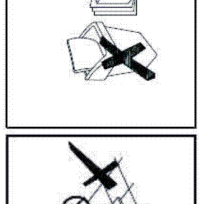
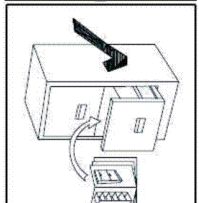
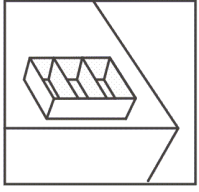
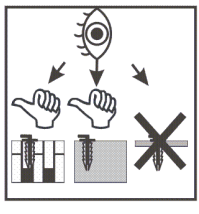
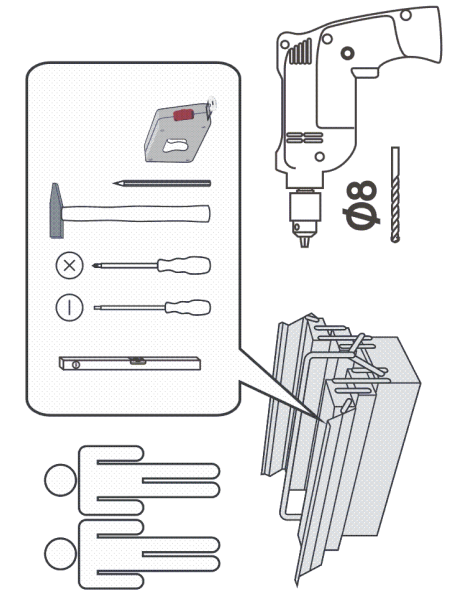
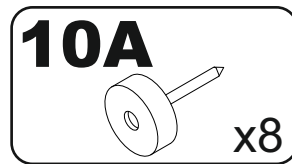
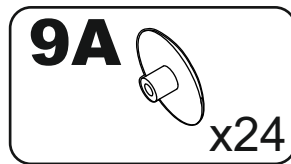
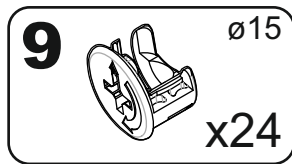
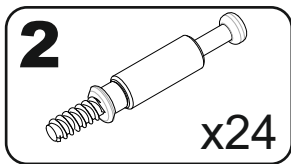
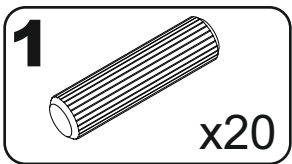
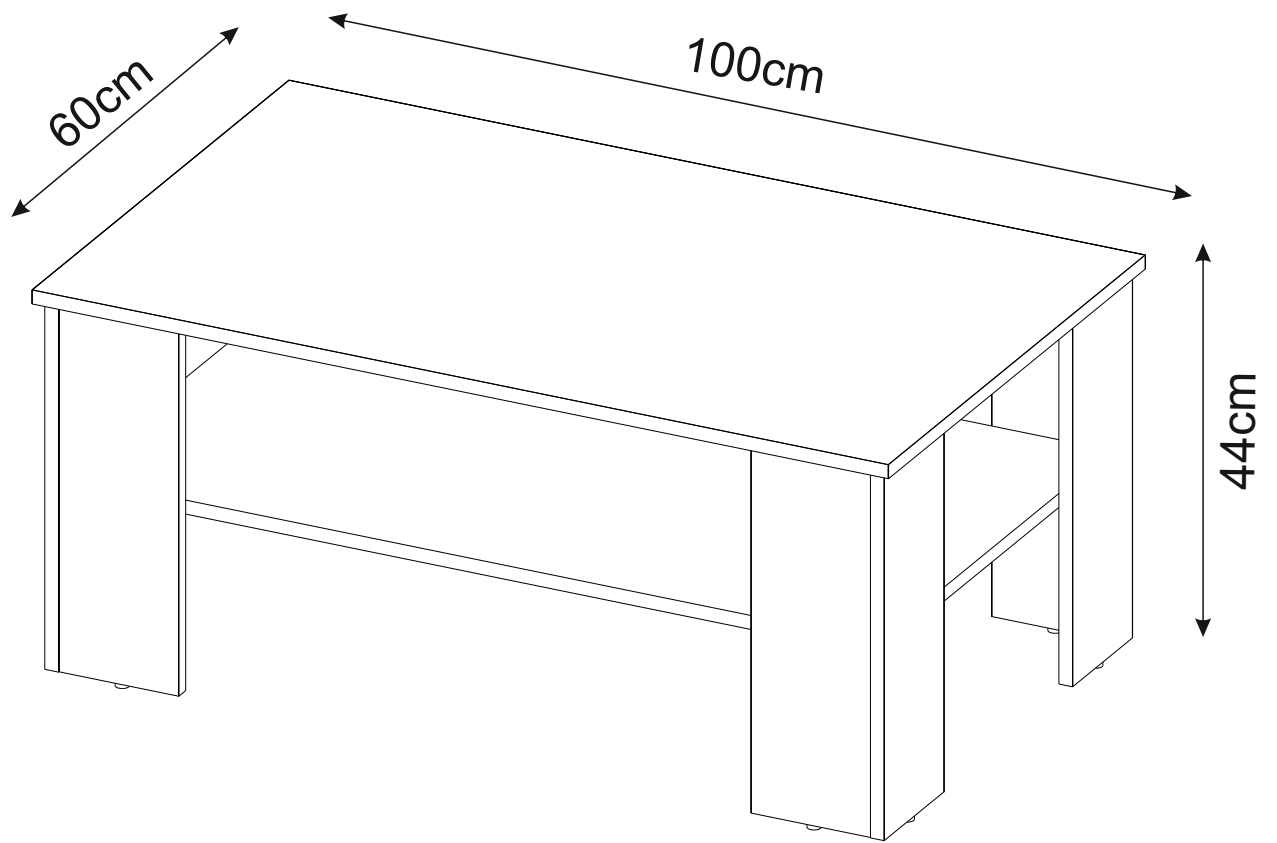
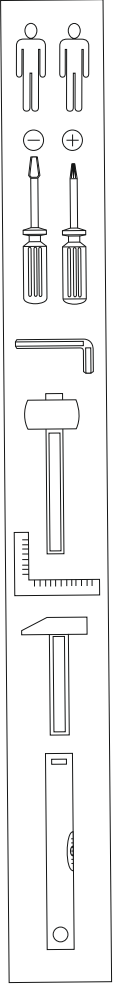
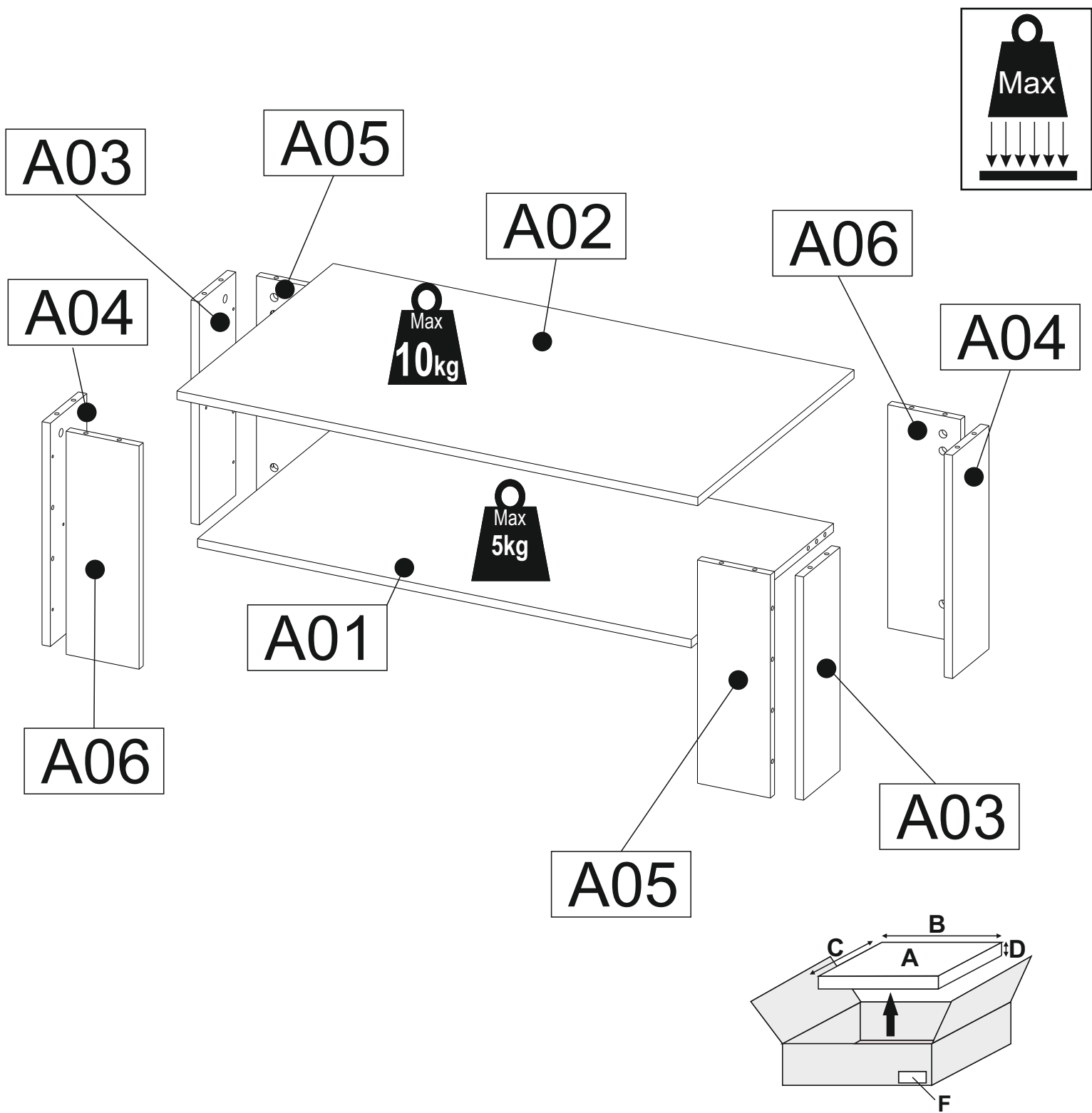

A	B (mm)	C (mm)	D (mm)	E	F
A01	948	546	16	1	1 1
A02	1000	600	16	1	1 1
A03	420	140	16	2	1 1
A04	420	140	16	2	1 1
A05	420	140	16	2	1 1
A06	420	140	16	2	1 1

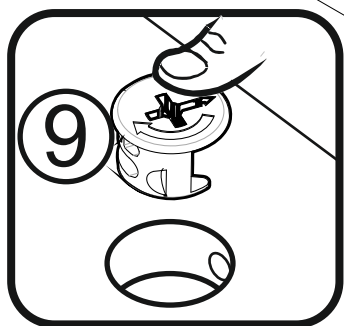
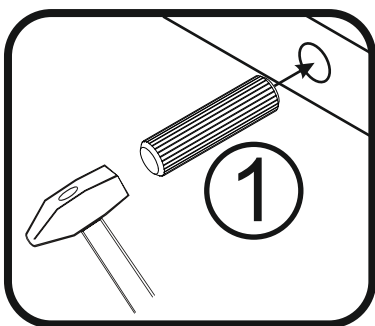
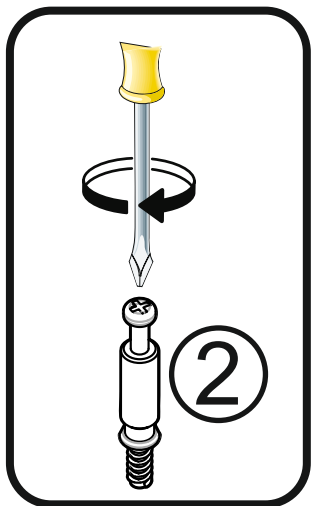
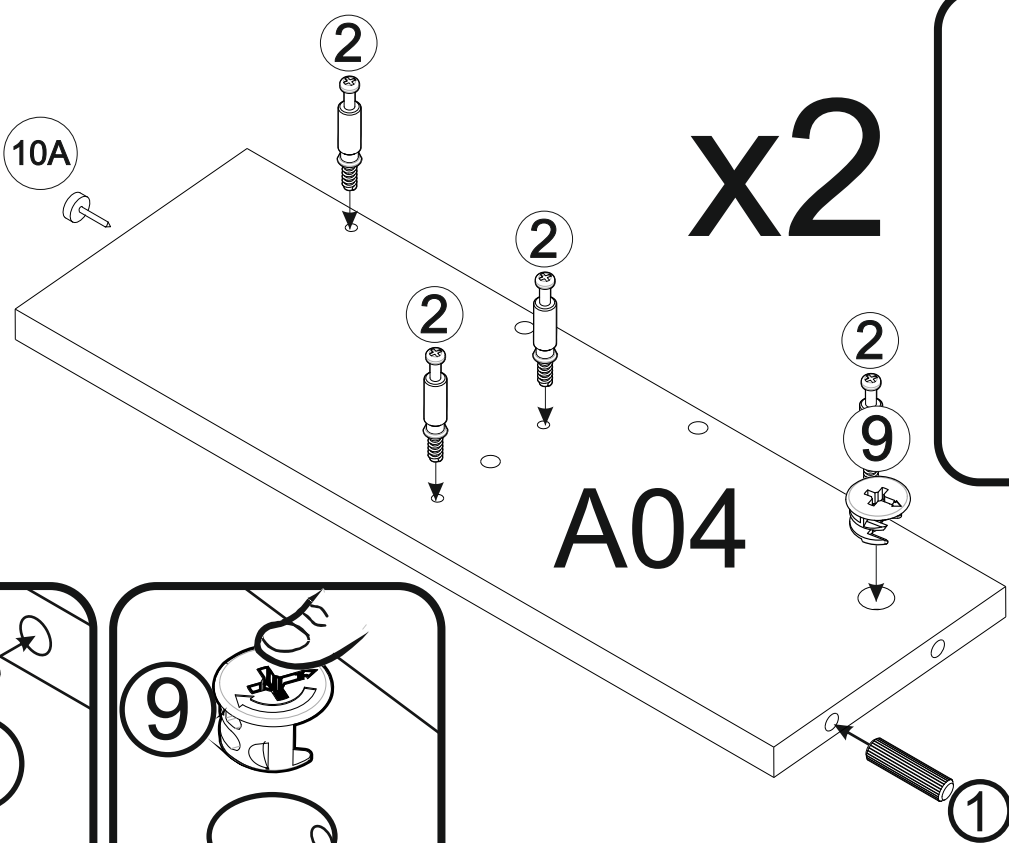
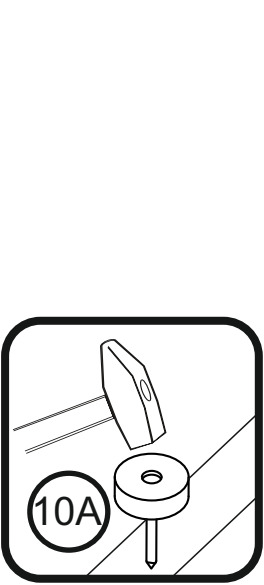
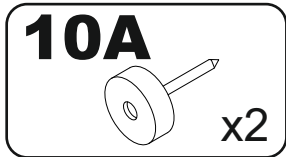
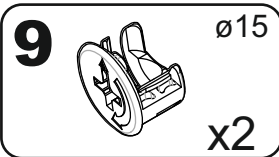
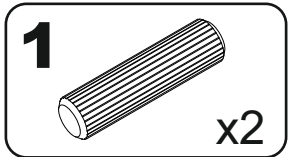
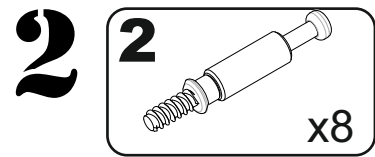
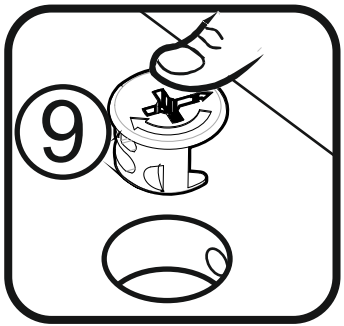
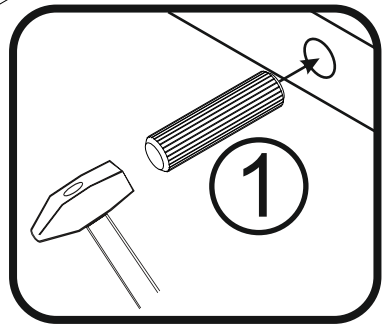
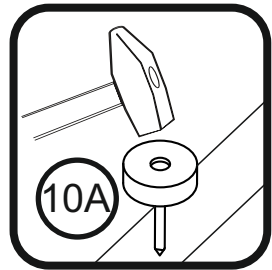
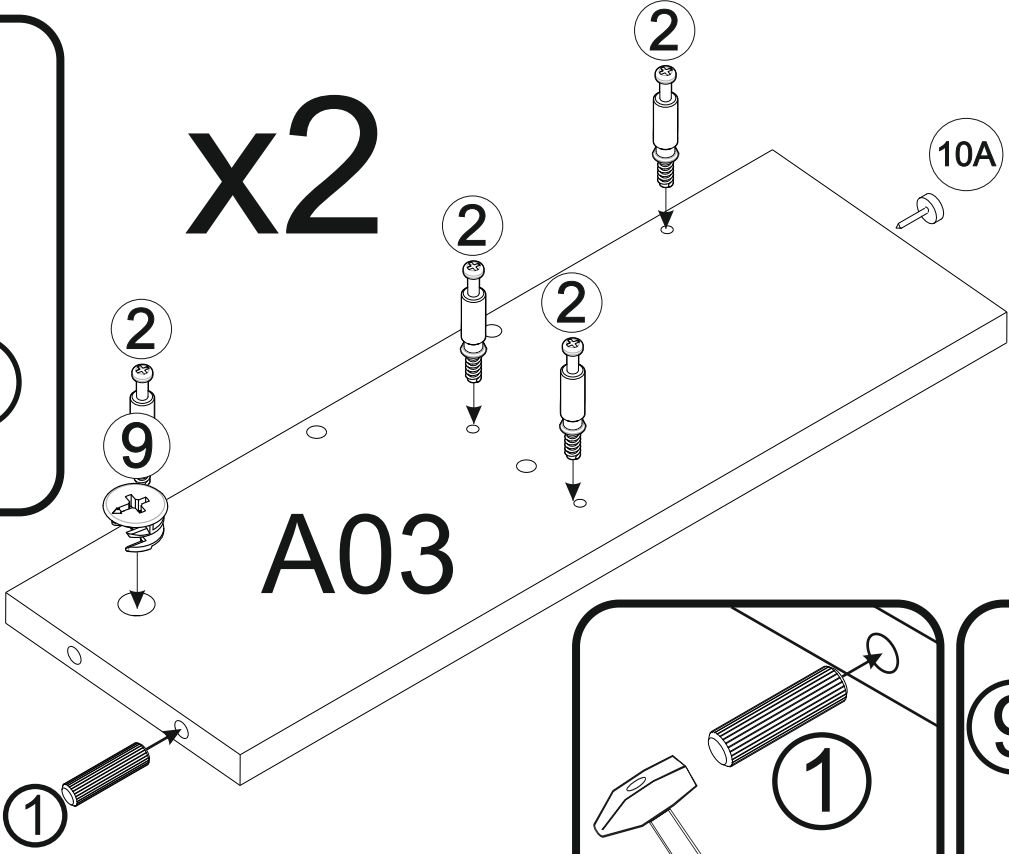
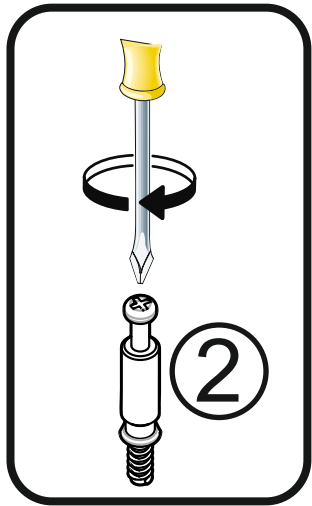
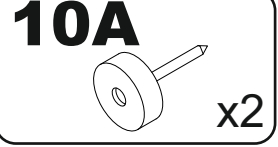
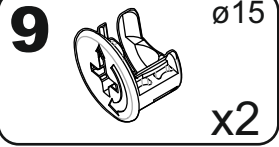
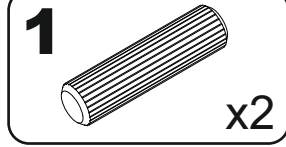
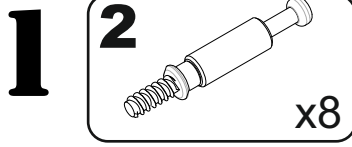

3

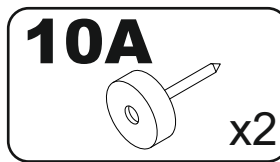
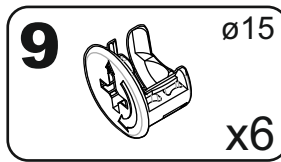
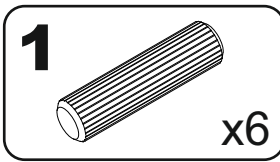

x2

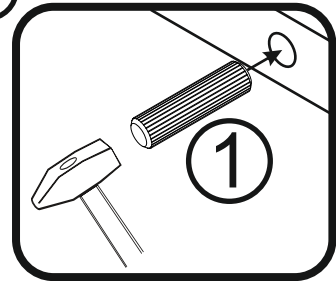
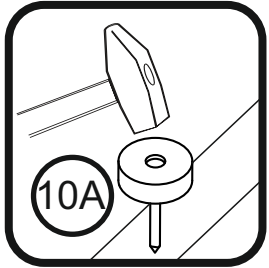
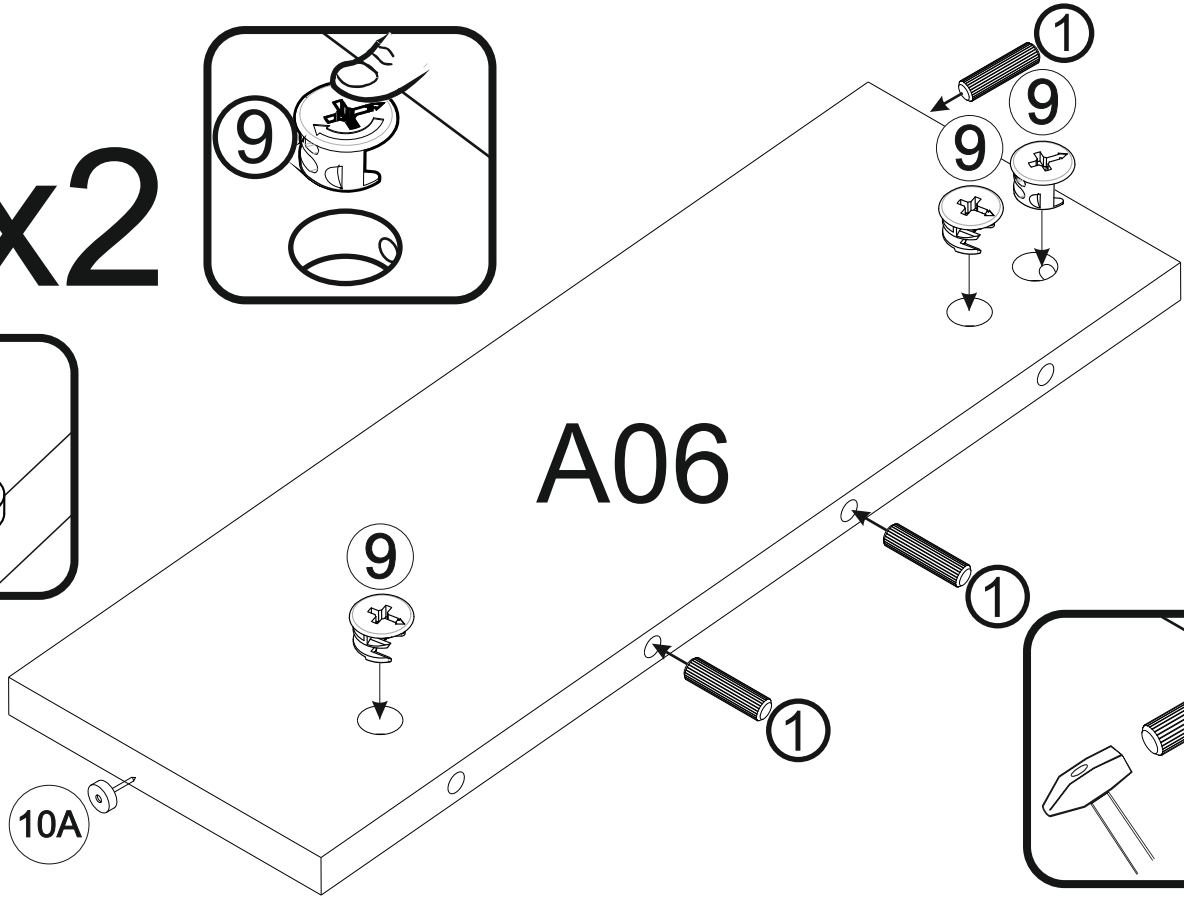
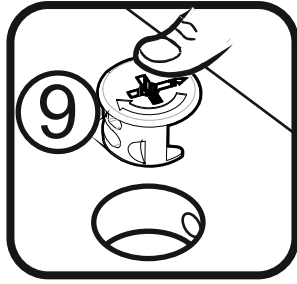

4

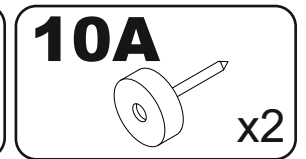
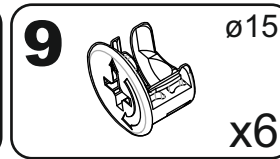
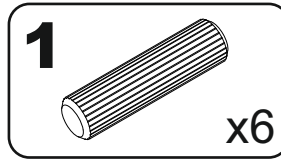

x2

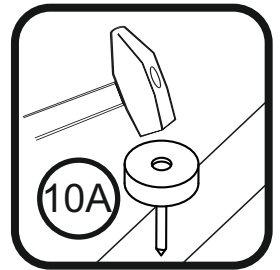
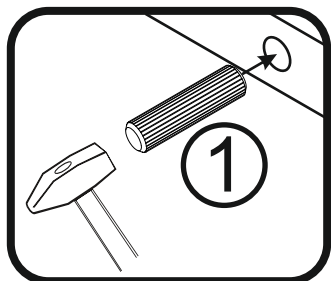
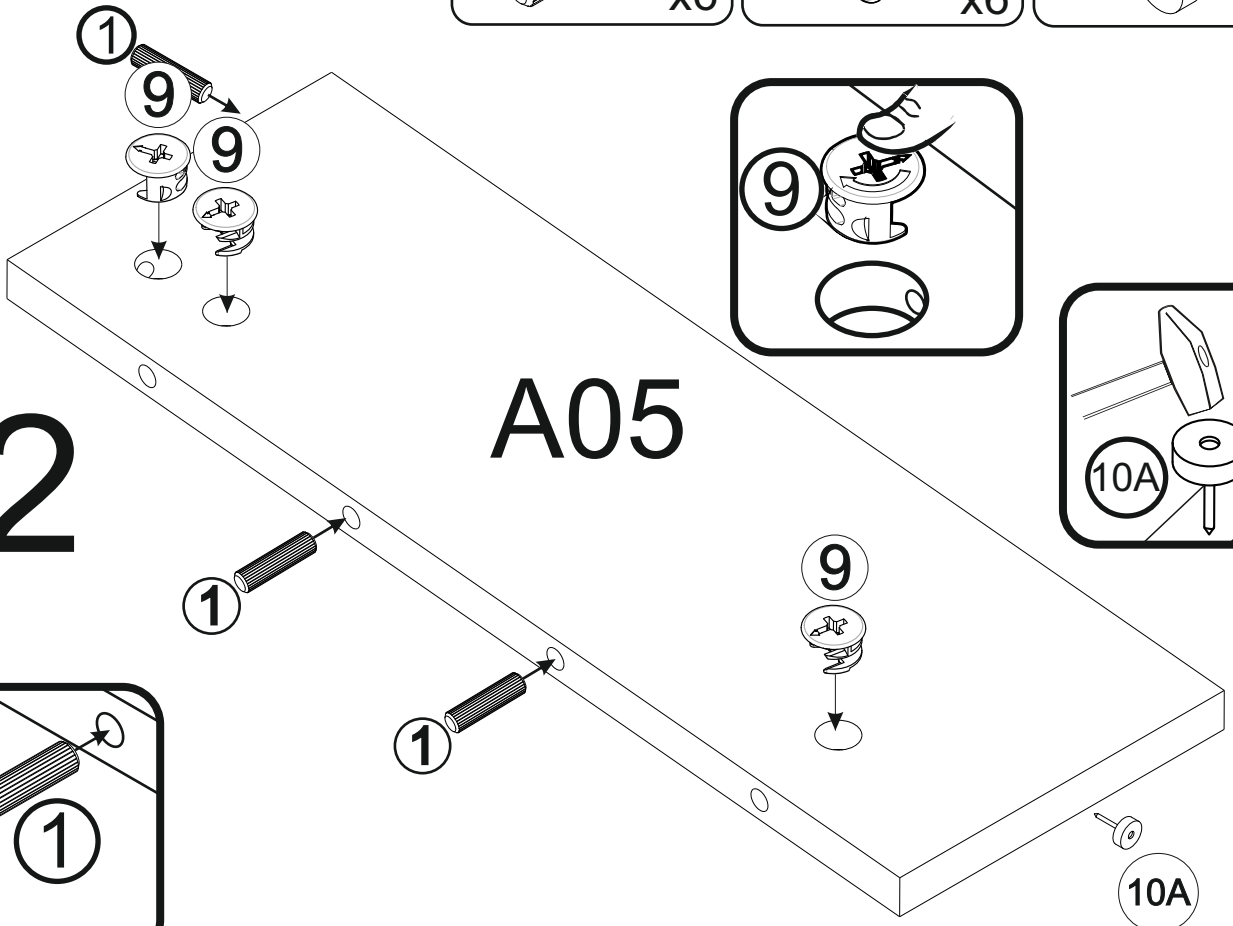
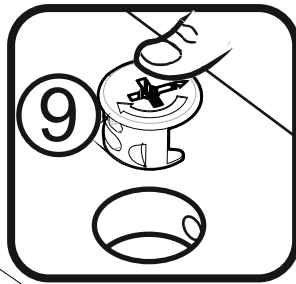

5

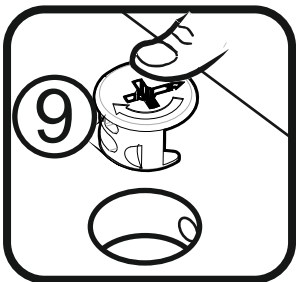
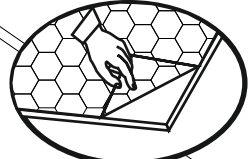
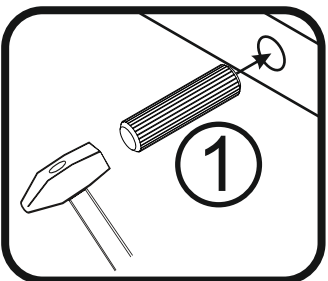
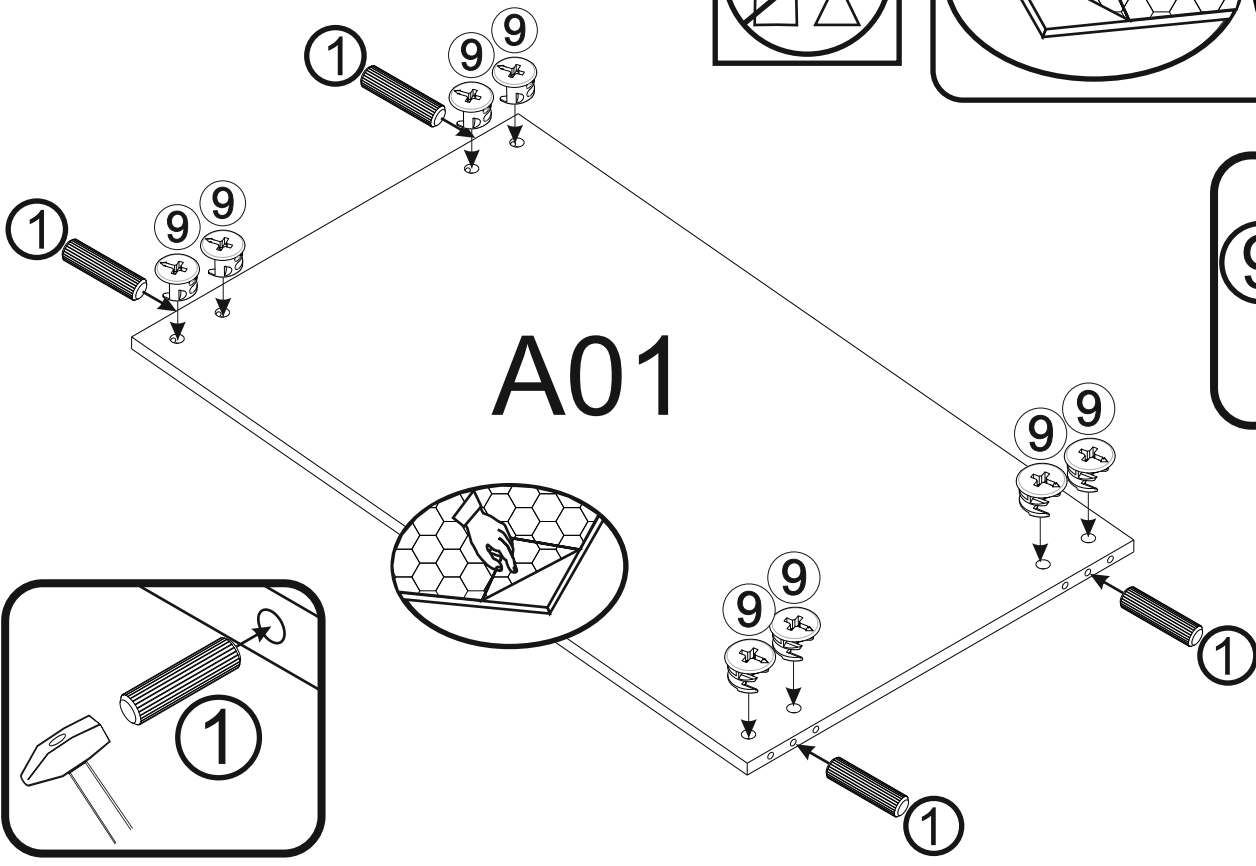
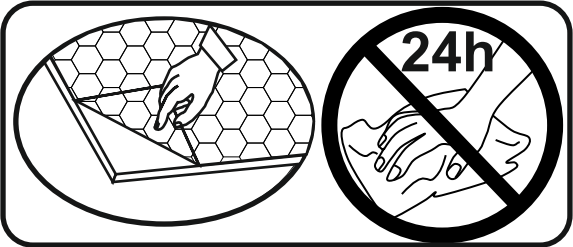
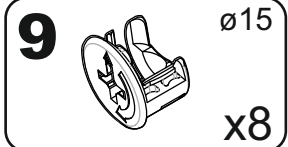
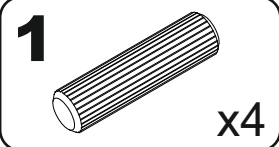

6

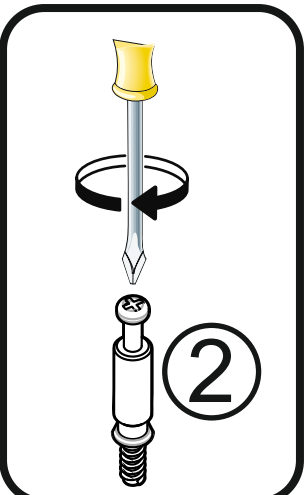
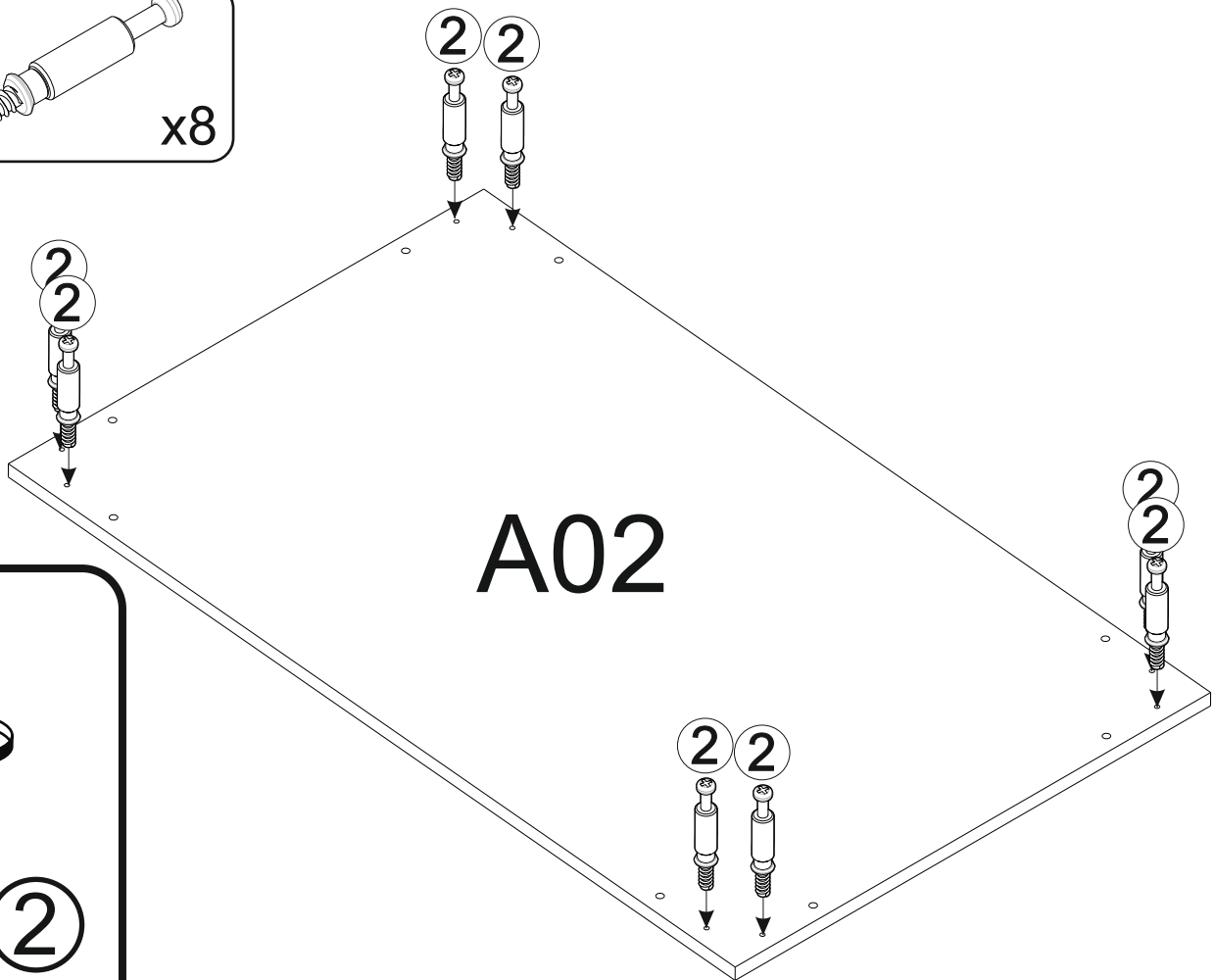
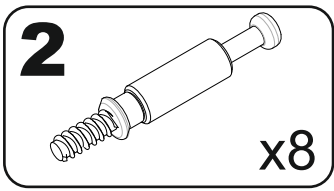

7

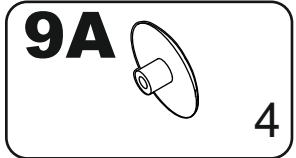
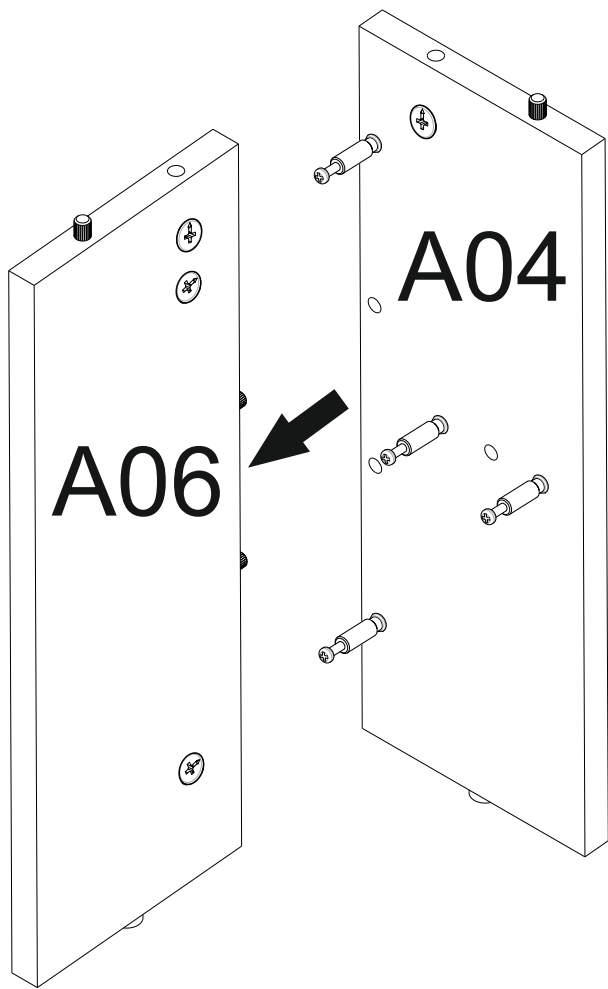

x2

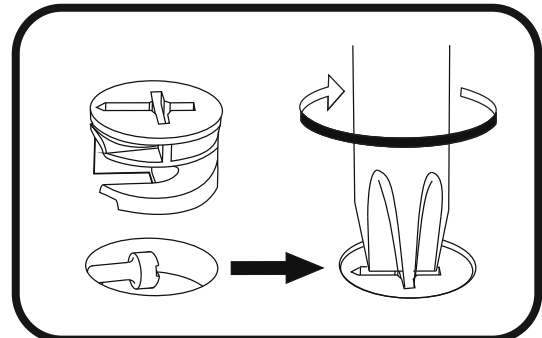
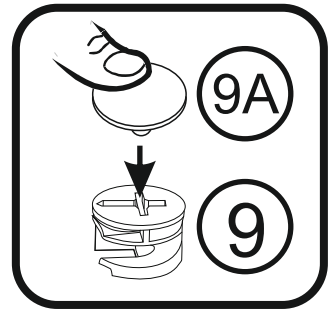

8

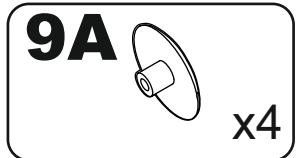
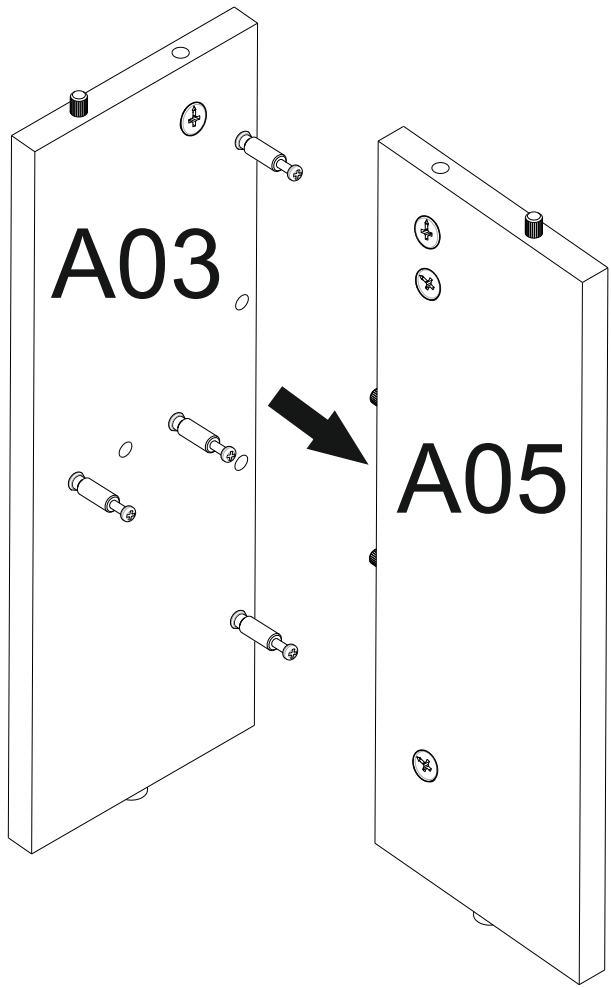

x2

