

# MONTANA

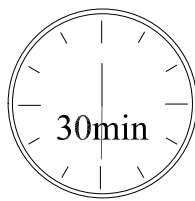

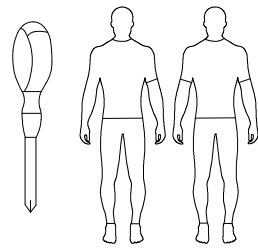
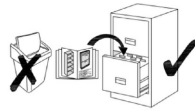
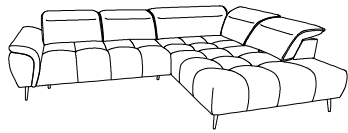
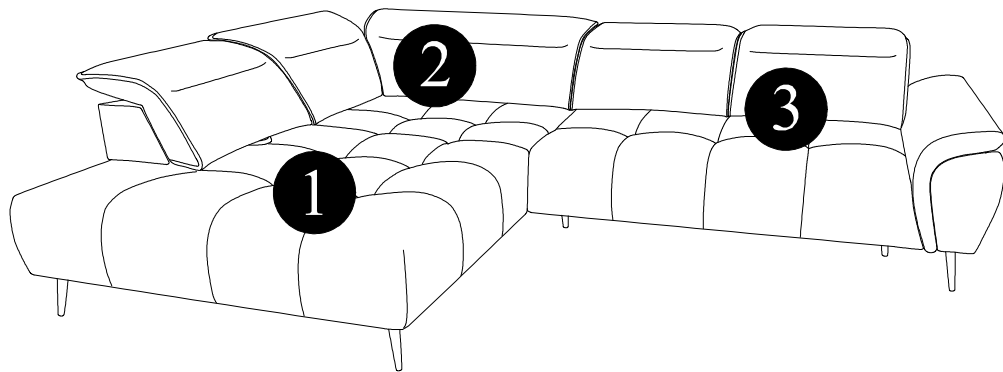

Teil	L	W	H	Pcs	Colli
1	142	115	62	1x	1/4
2	136	102	62	1x	2/4
3	166	108	62	1x	3/4

**L**

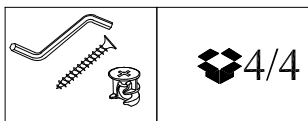
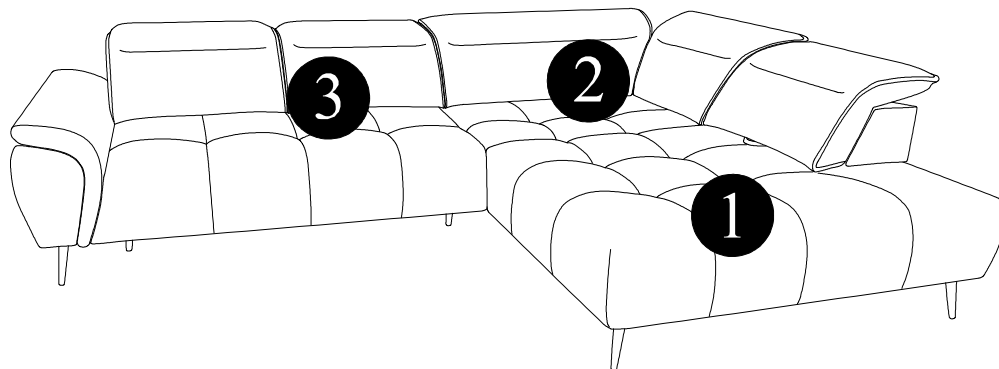

**R**

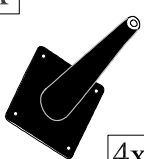

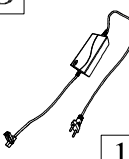
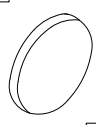
A	B	C	D	E
				
4x	7x	16x	1x	7x
H-155	H-150	5x30		

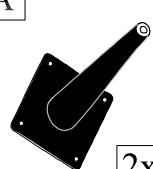
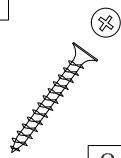
	
<p>H-155</p>	<p>5x30</p>

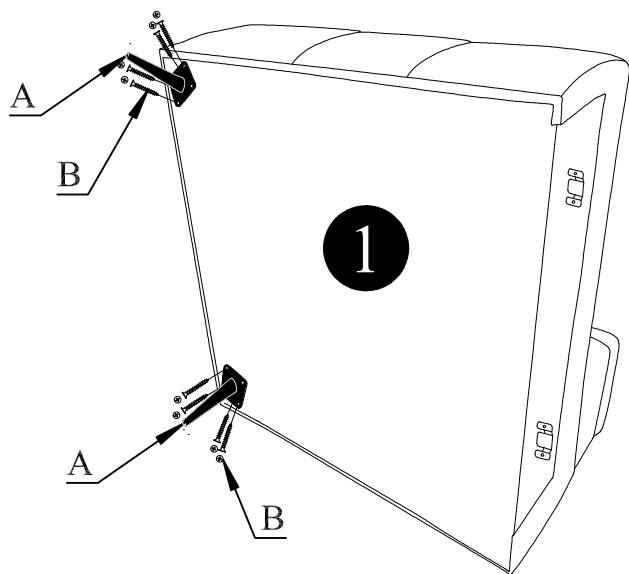

1

L



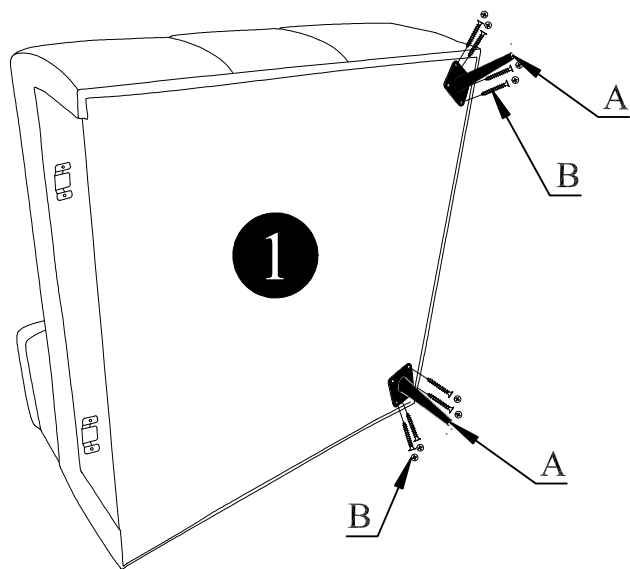

R

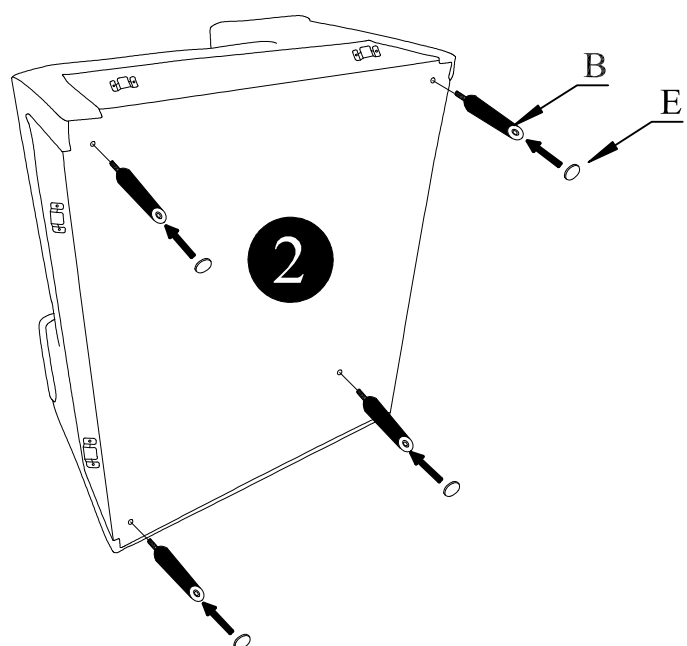
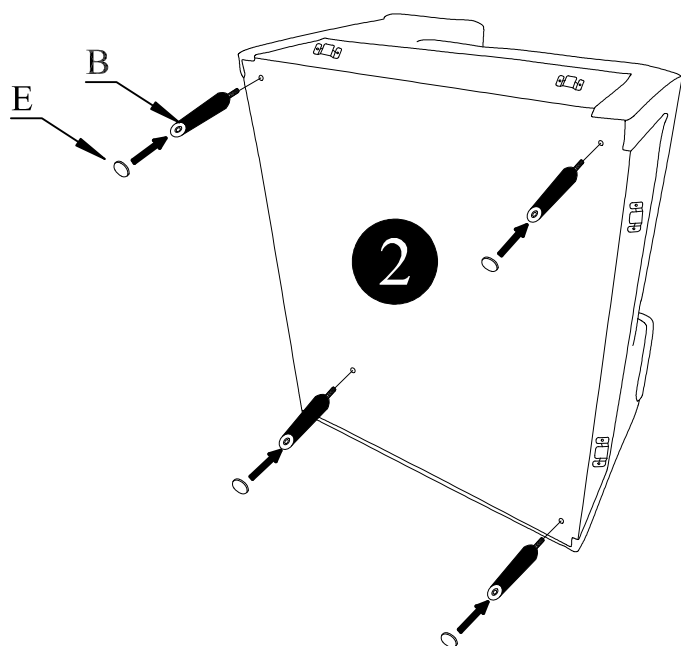

	
<p>H-150</p>	

2

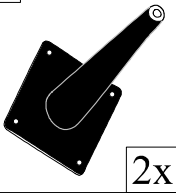

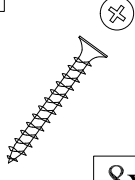
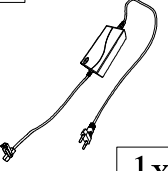
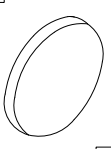
A  2x	B  3x	C  8x	D  1x	E  3x
H-155	H-150	5x30		

3

L

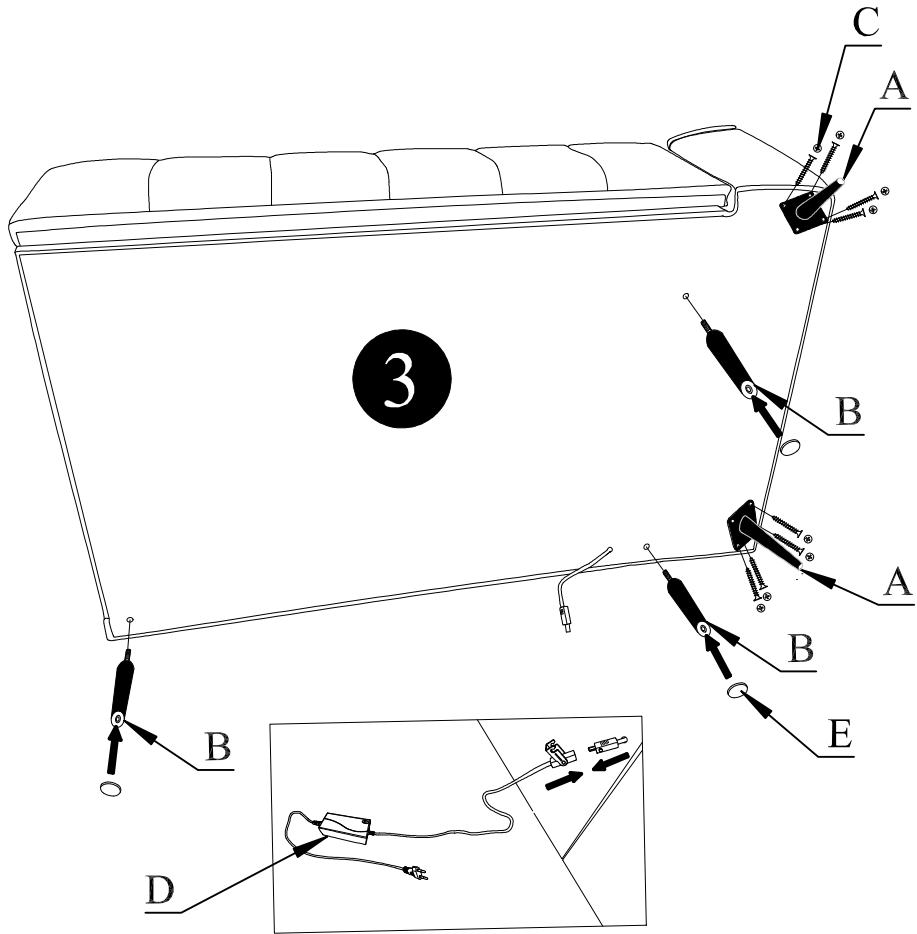

R

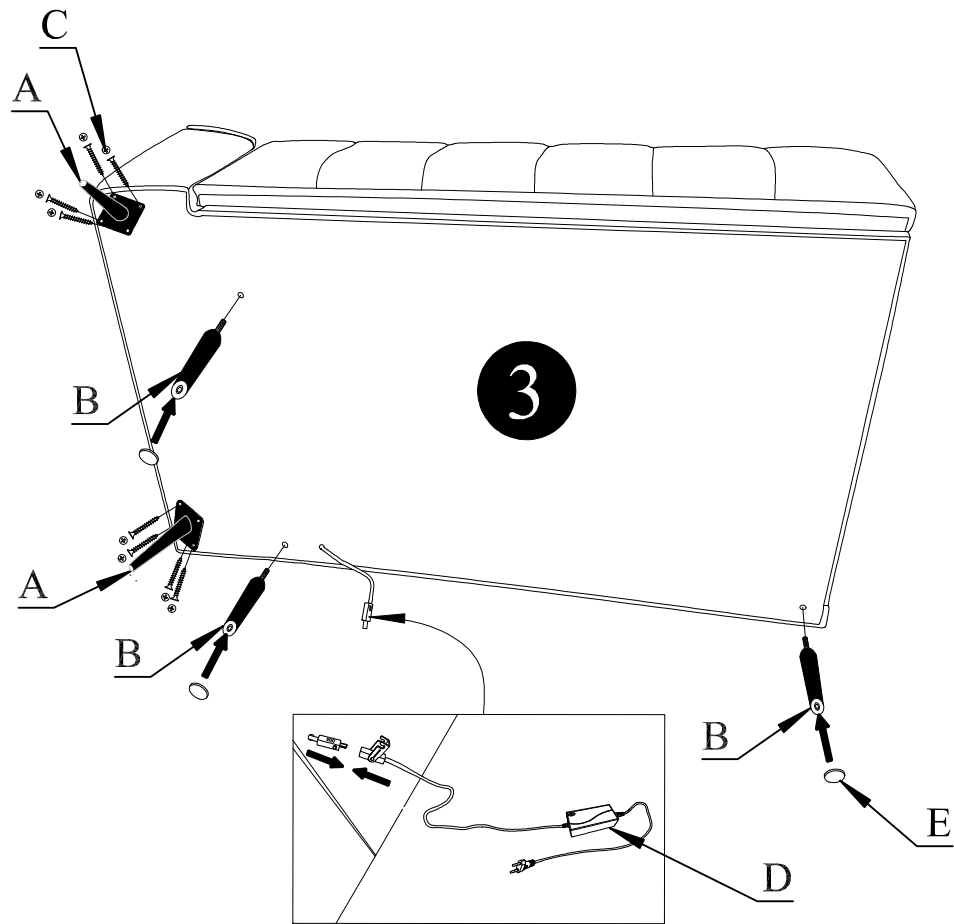

4

