

PAMPLONA RTV

45720689

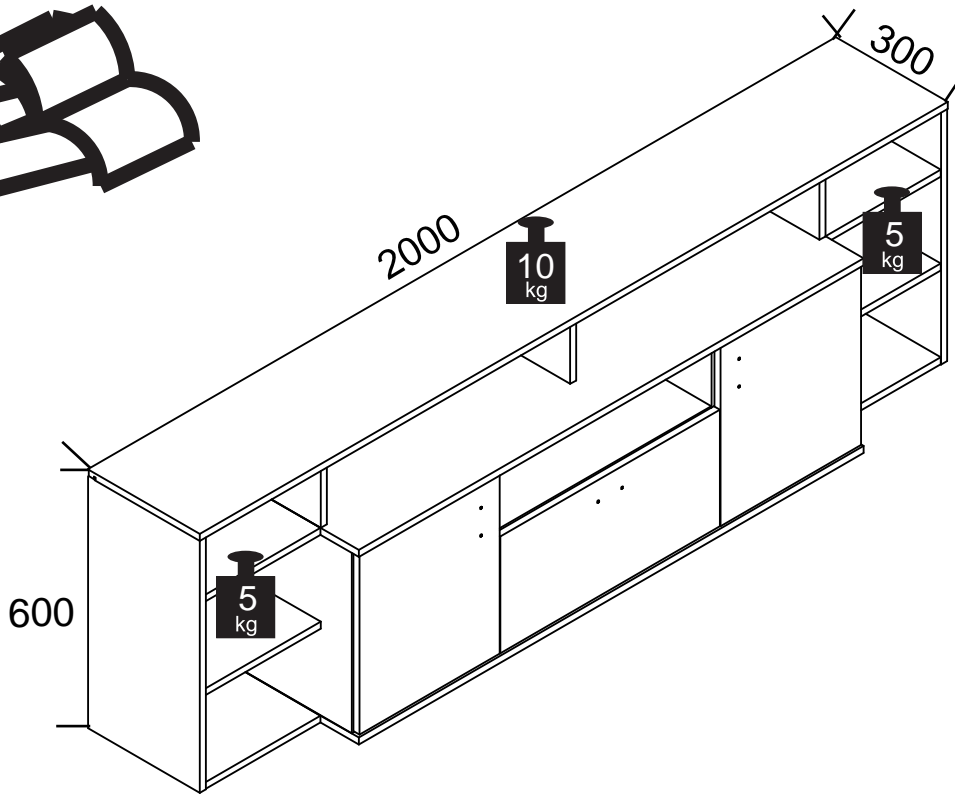

NUMBER	L	W	T	COUNT	COLI
1	2000	300	16	1	2/2
2	1350	382	16	1	1/2
3	1350	382	16	1	1/2
4a + 4b	308	280	16	6	2/2
5	584	299	16	1	2/2
6	584	299	16	1	2/2
7	418	363	16	2	1/2
8	418	363	16	1	1/2
9	418	363	16	1	1/2
10	133.5	280	16	3	2/2
11	574	362	16	1	1/2
12	412	375.5	16	1	1/2
13	412	375.5	16	1	1/2
14	587	270	16	1	2/2
15	355	353	16	2	1/2
16	1976	147	3	1	2/2
17	1976	220	3	2	2/2

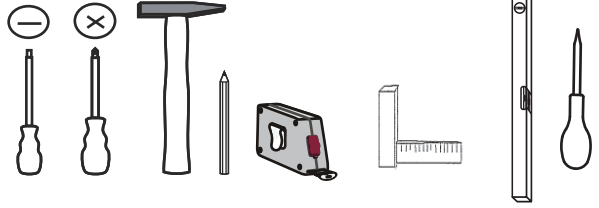
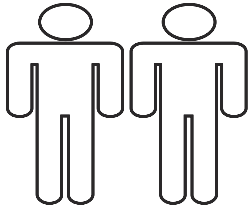
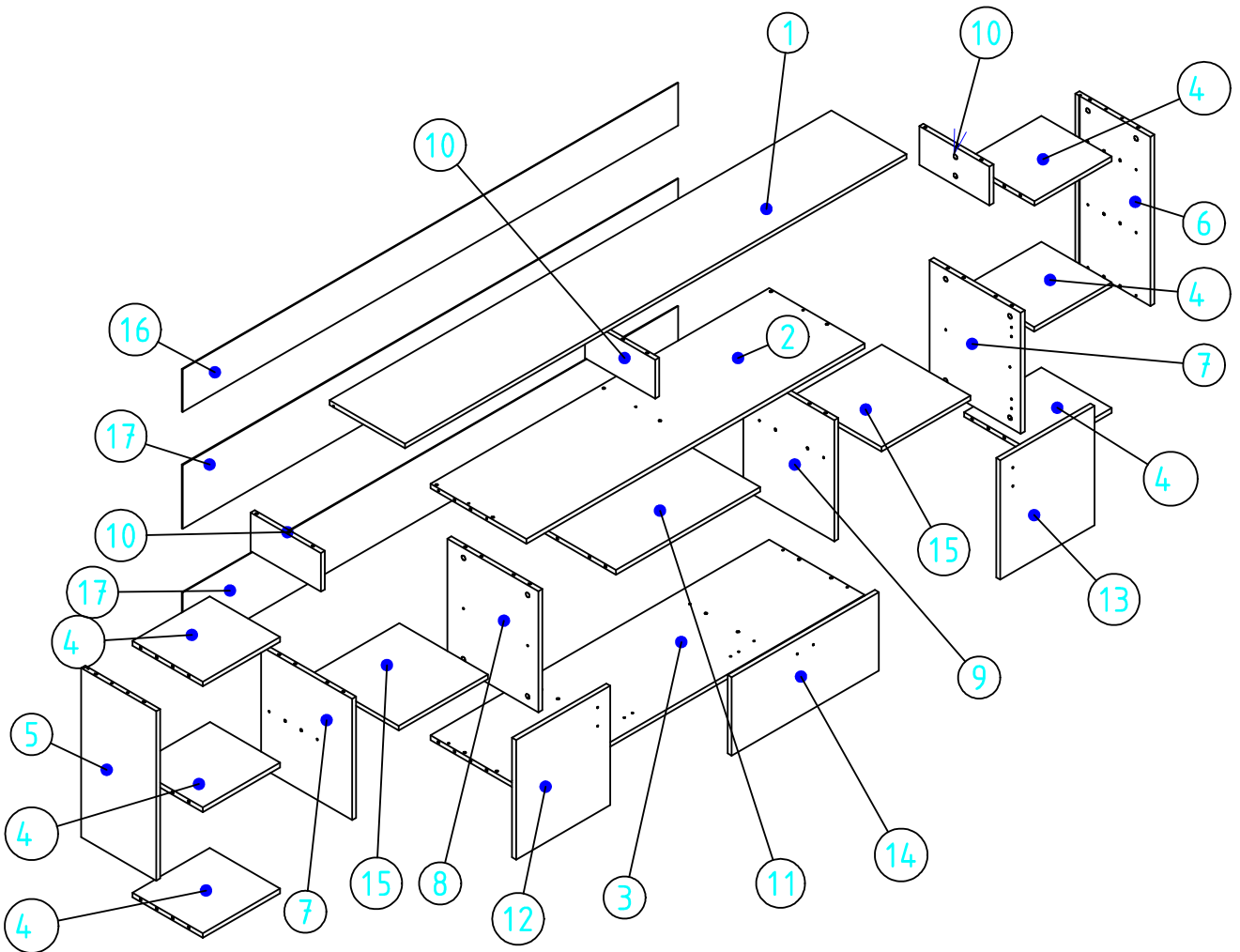
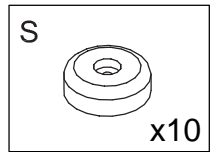
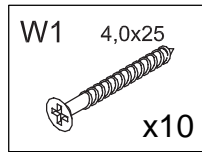
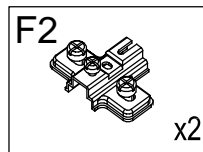
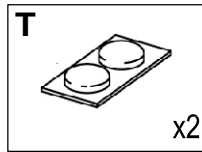
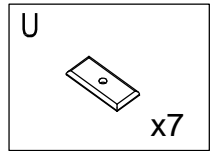
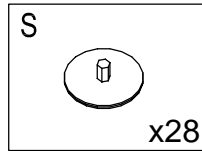
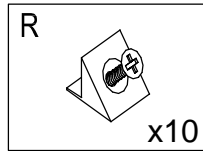
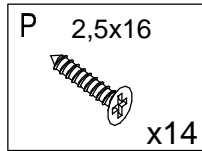
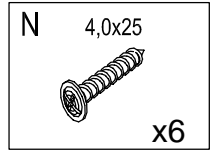
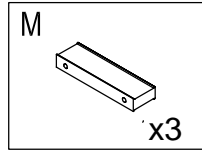
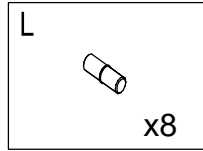
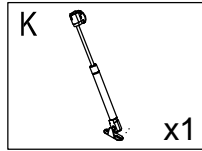
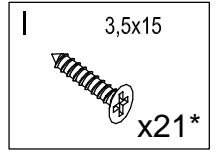
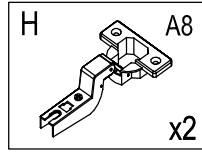
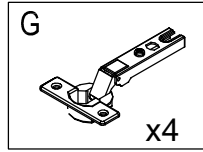
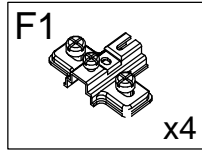
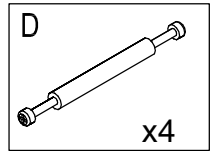
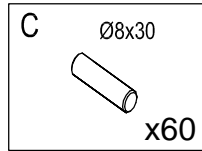
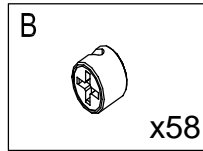
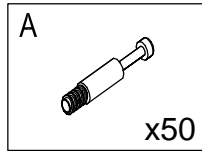
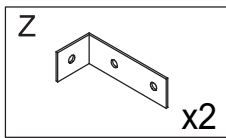
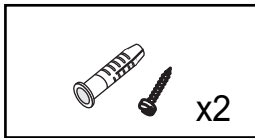

1

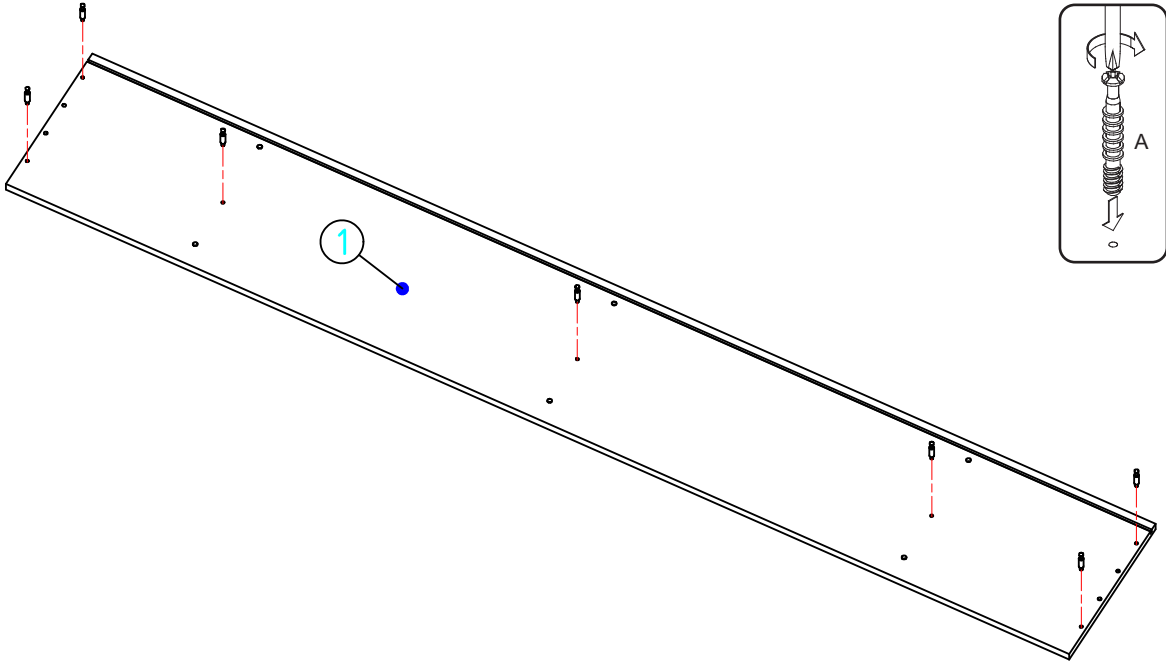
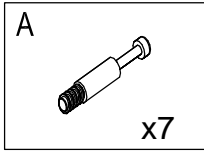

2

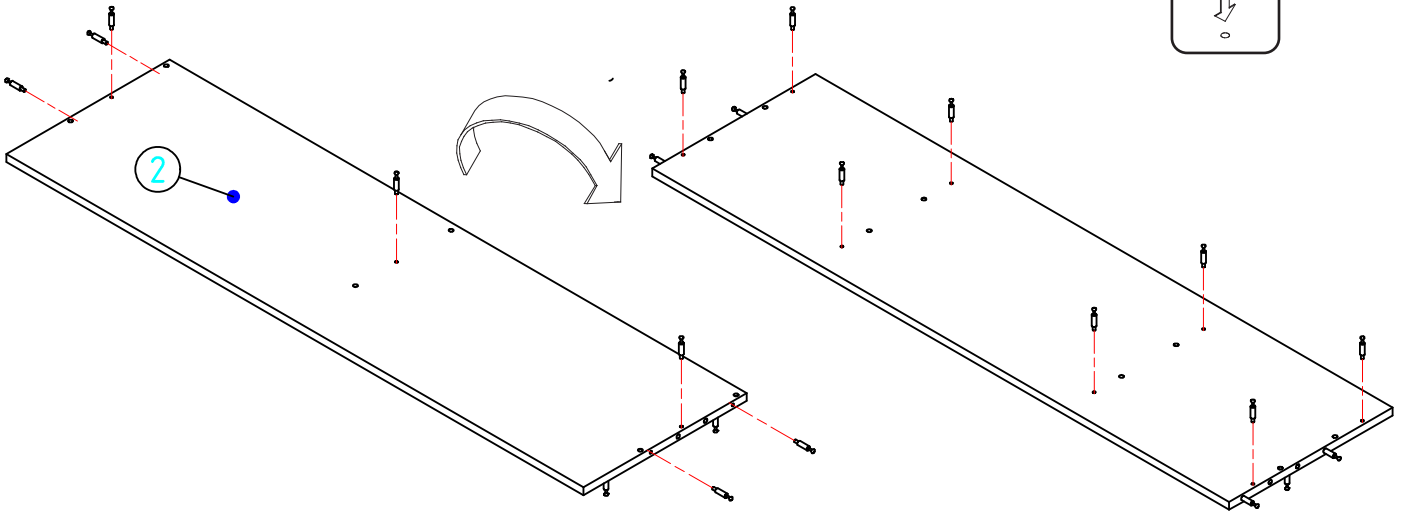
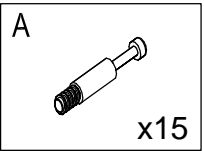

3

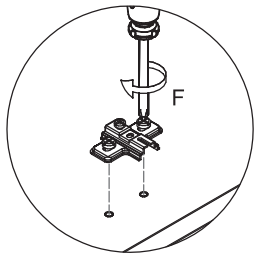
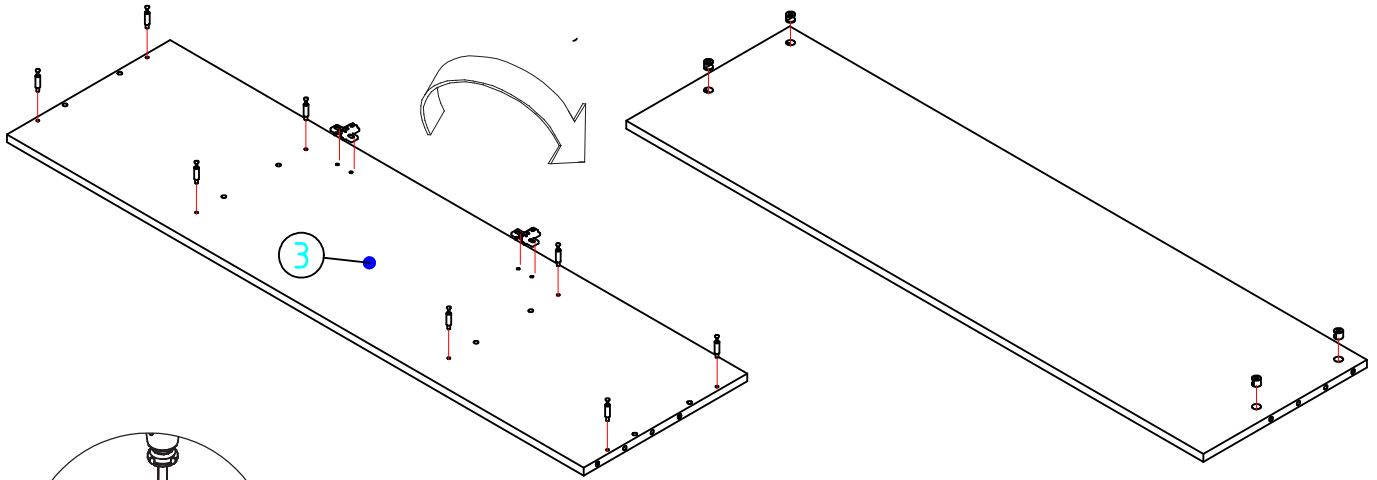
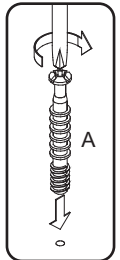
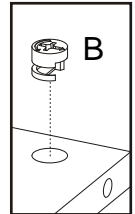
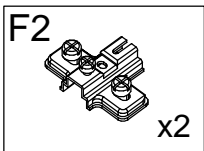
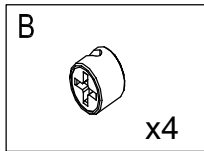
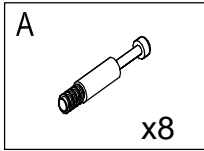

4

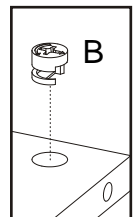
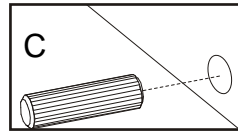
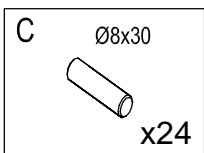
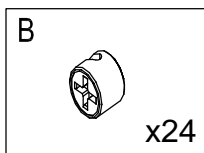

x6

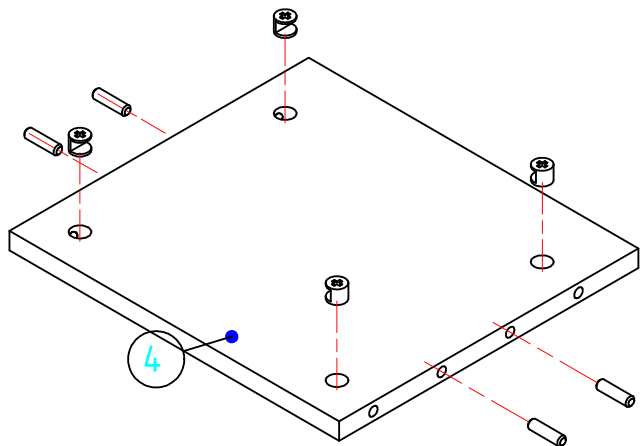

5

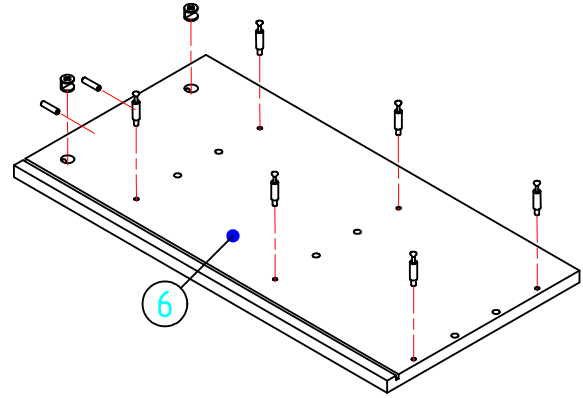
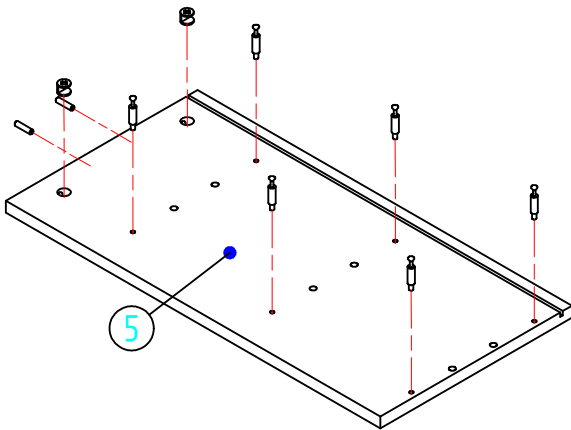
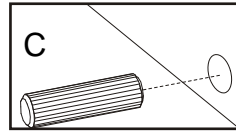
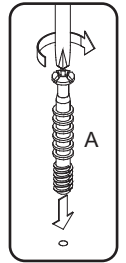
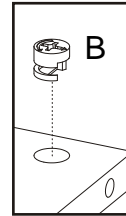
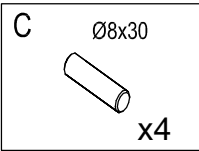
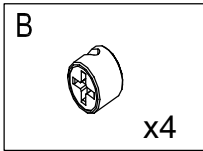
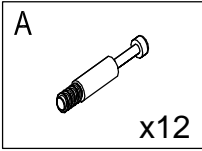

6

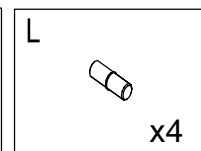
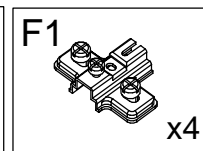
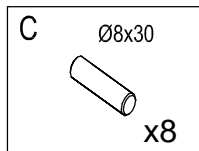
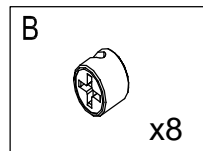
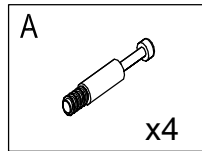

x2

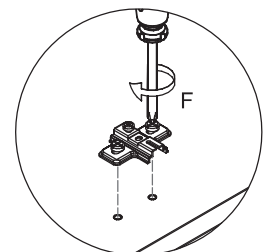
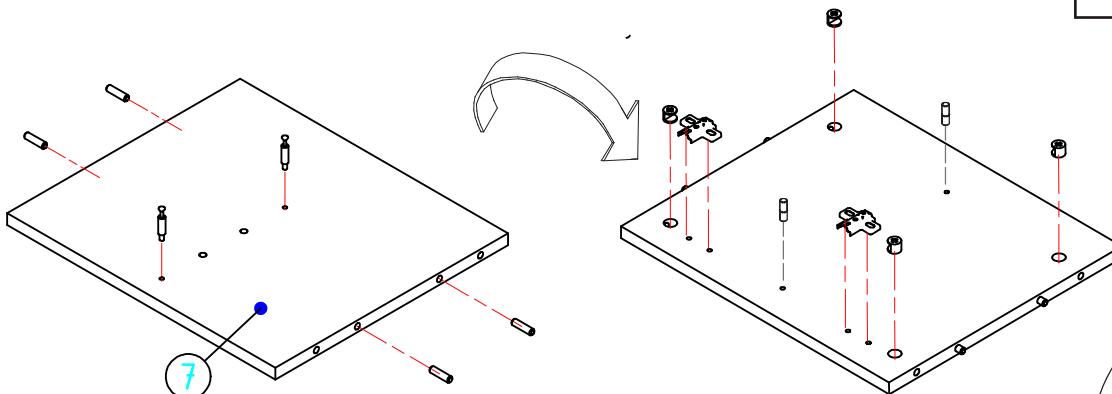
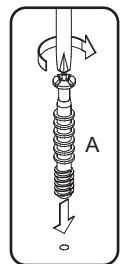
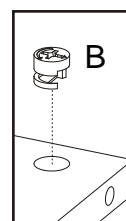
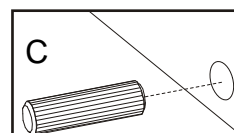

7

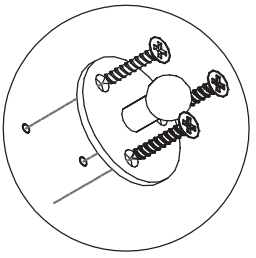
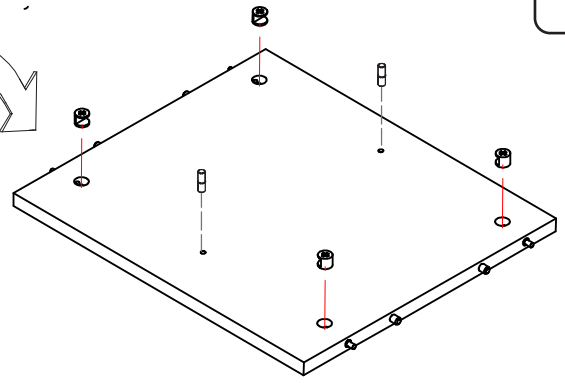
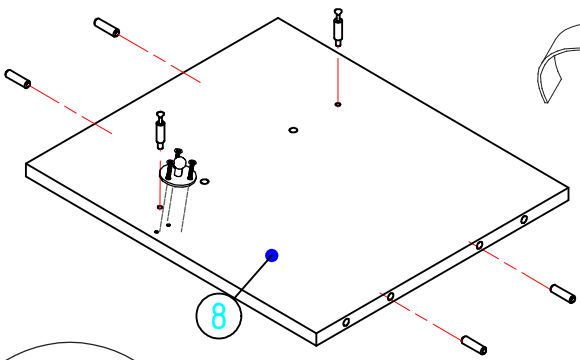
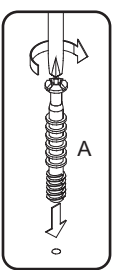
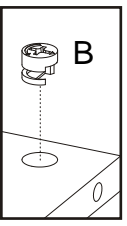
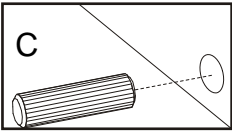
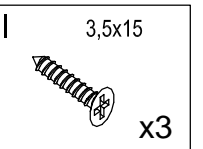
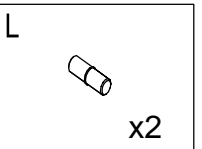
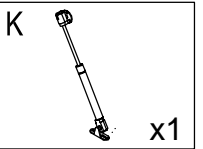
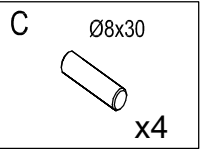
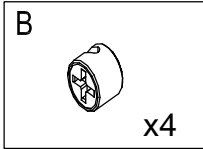
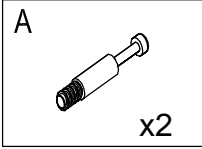

8

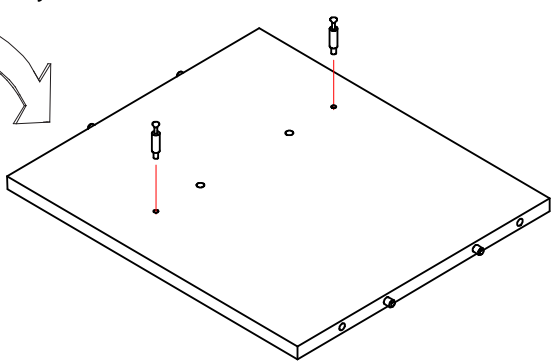
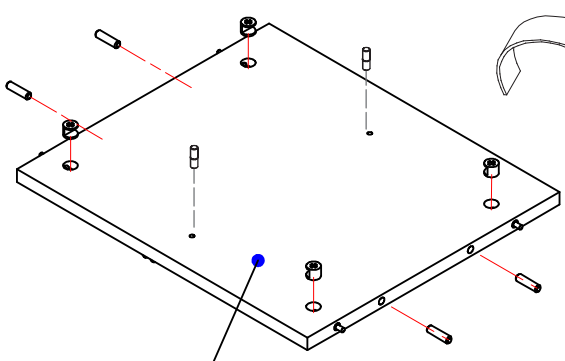
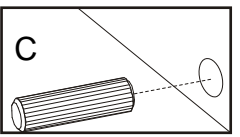
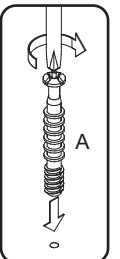
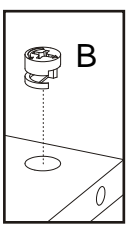
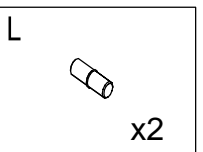
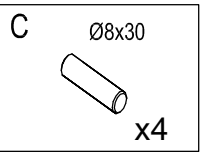
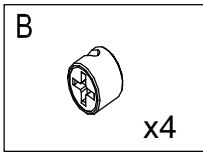
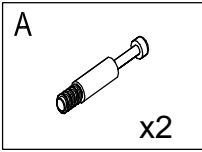

9

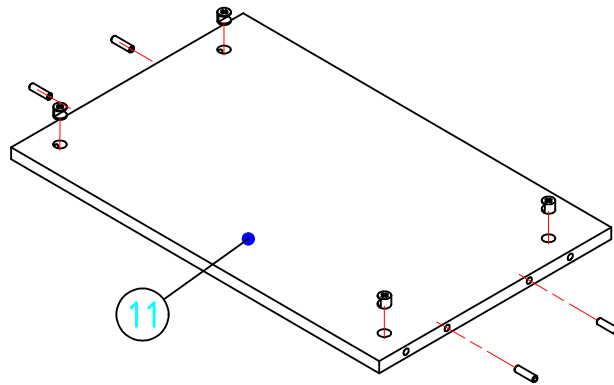
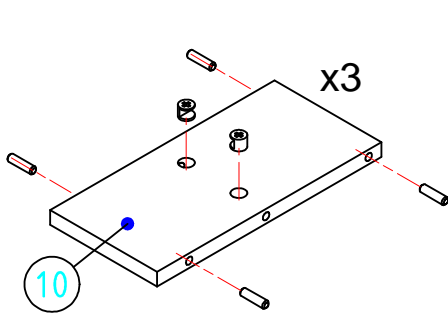
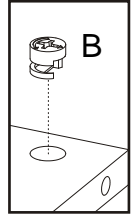
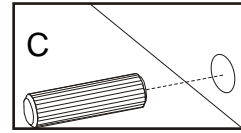
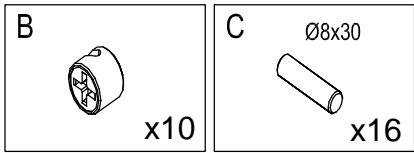

10

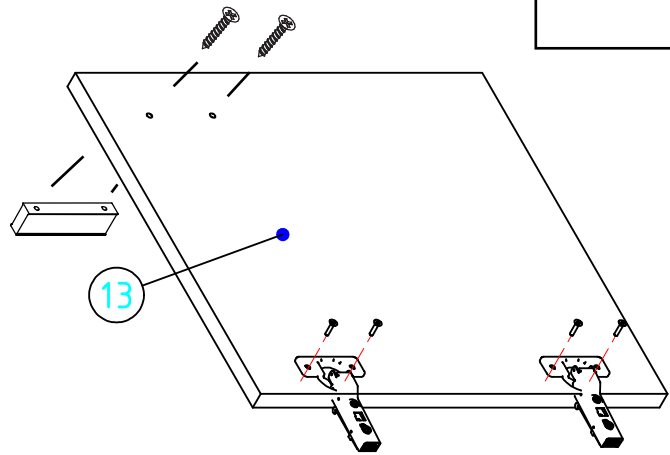
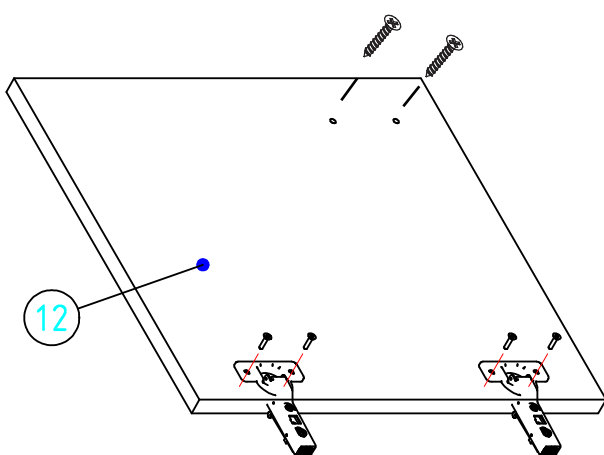
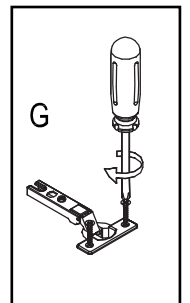
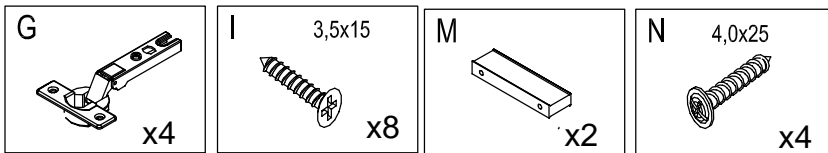

11

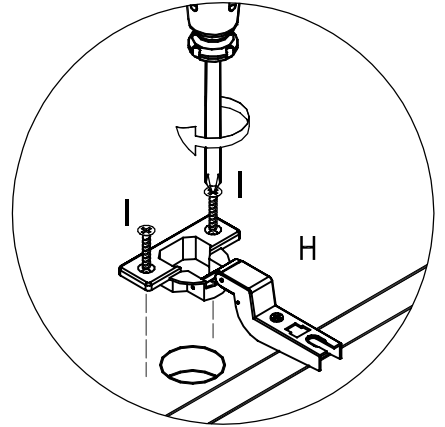
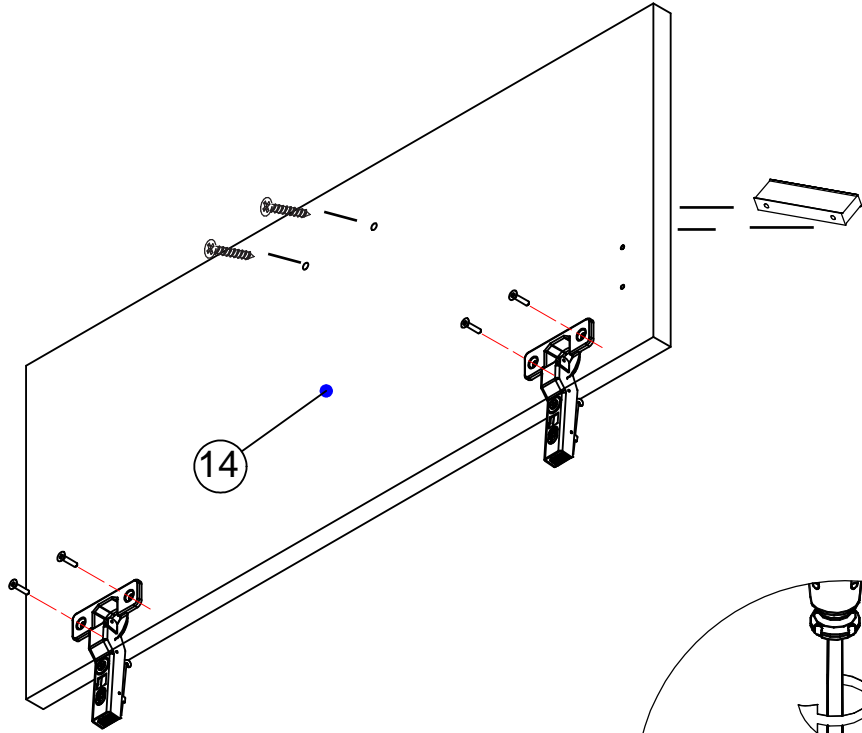
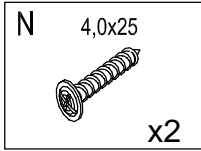
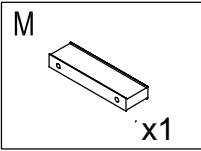
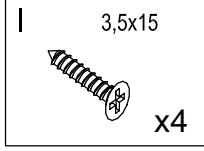
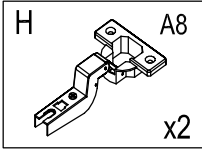

12

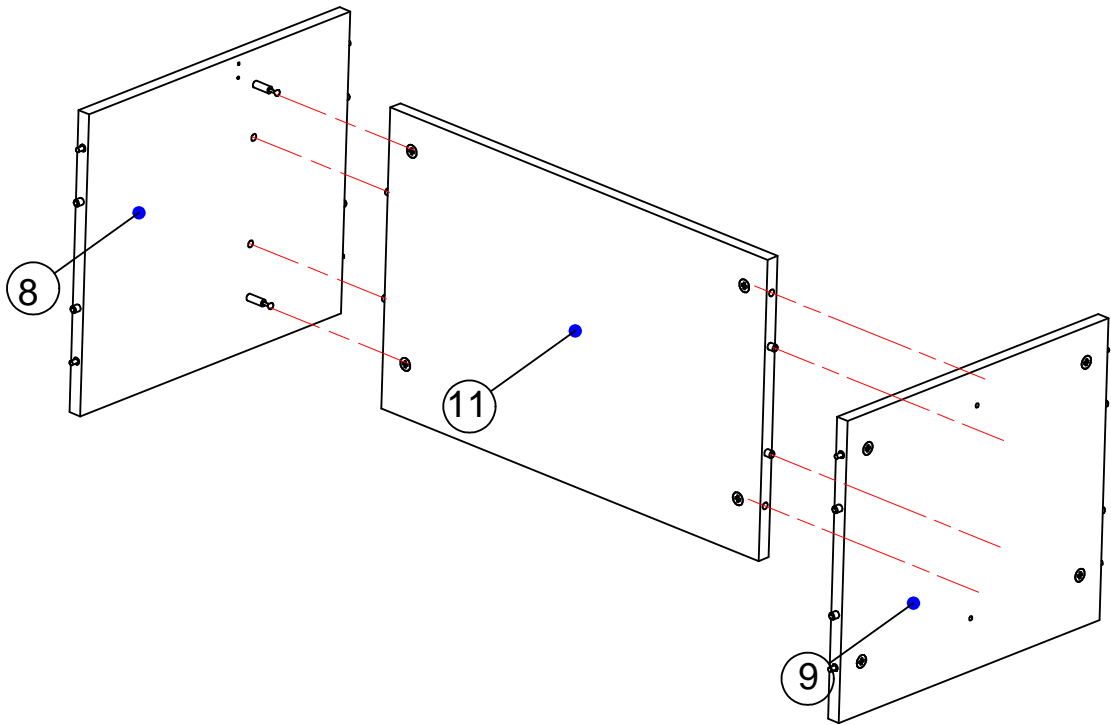
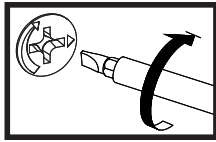

13

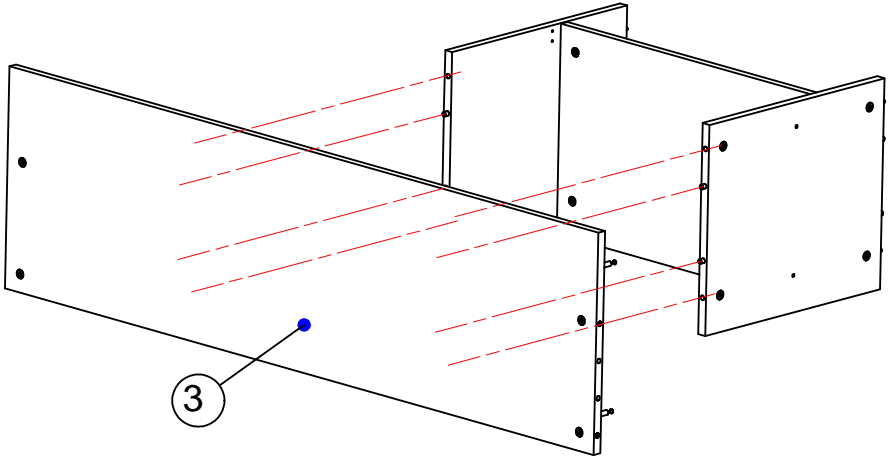
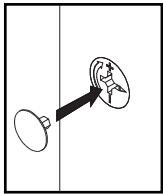
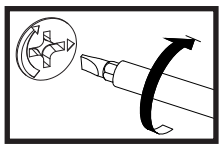
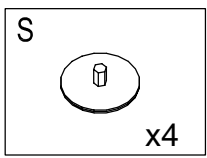

14

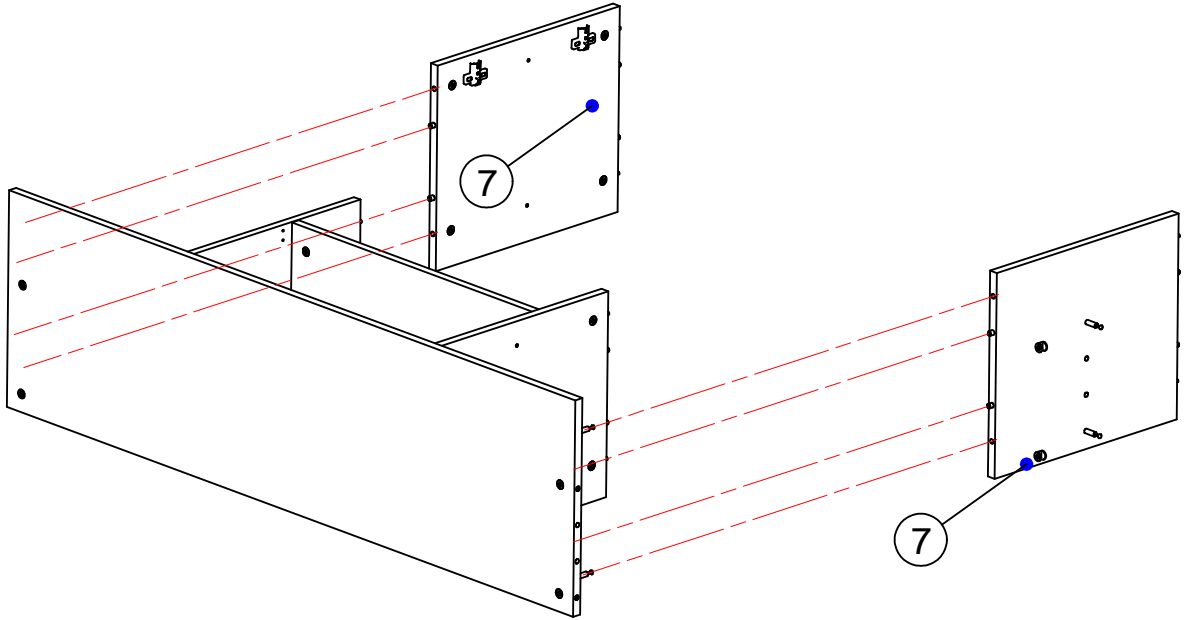
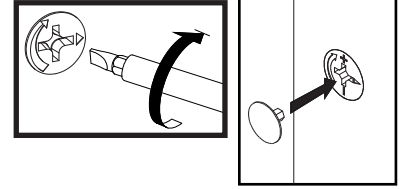
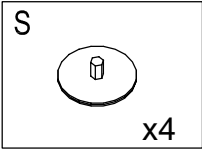

15

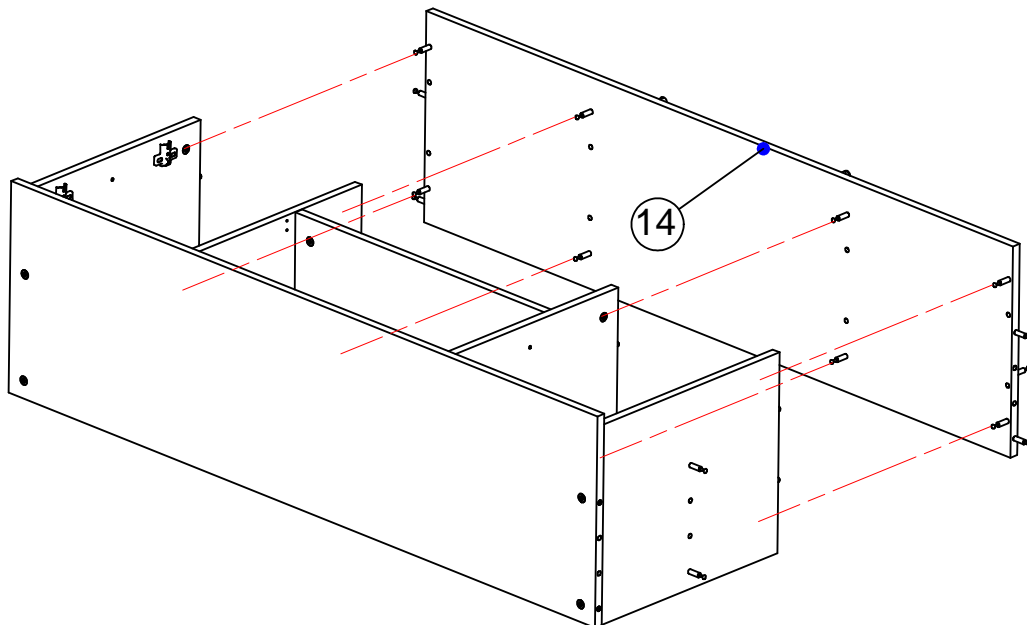
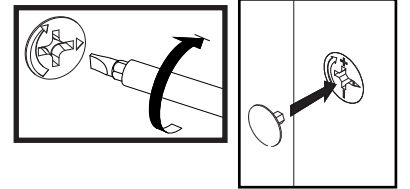
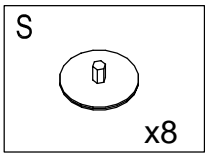

16

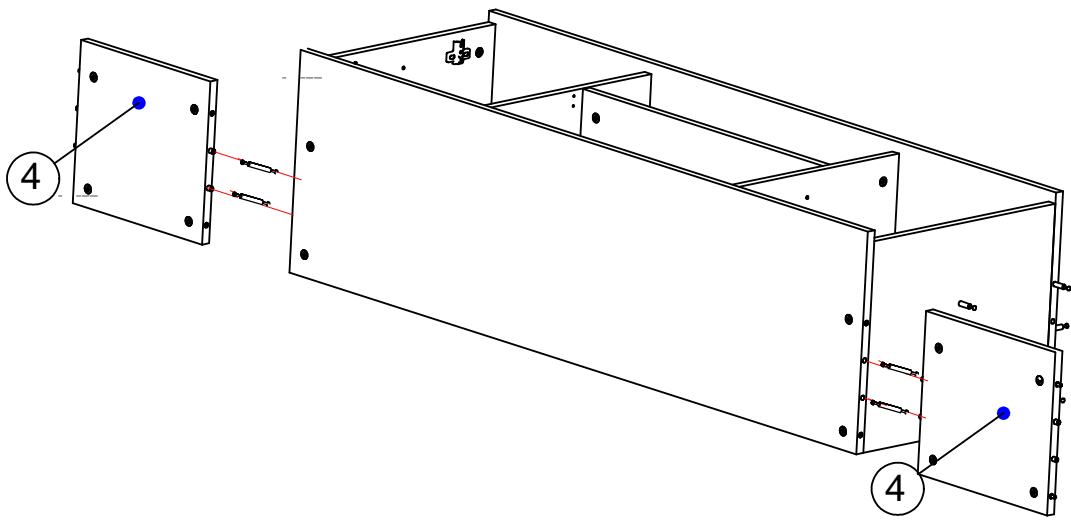
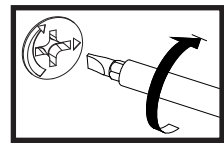
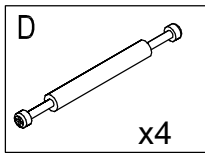

17

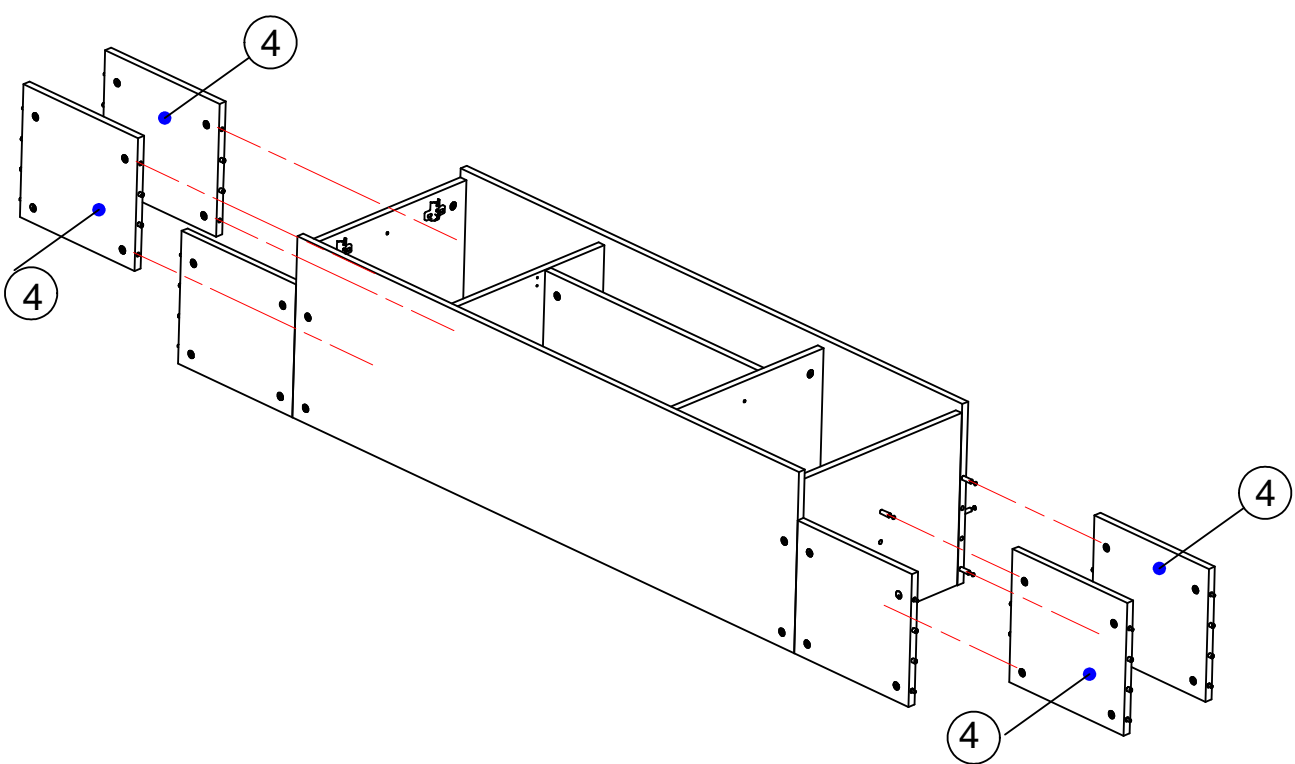
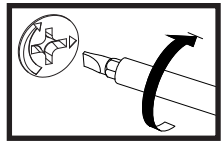

18a

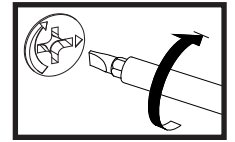
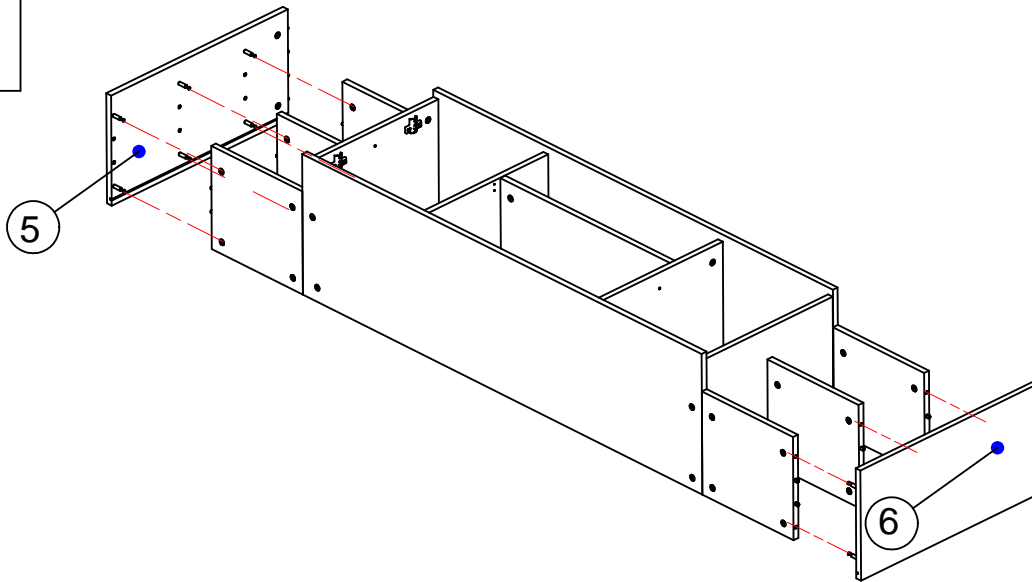

18b

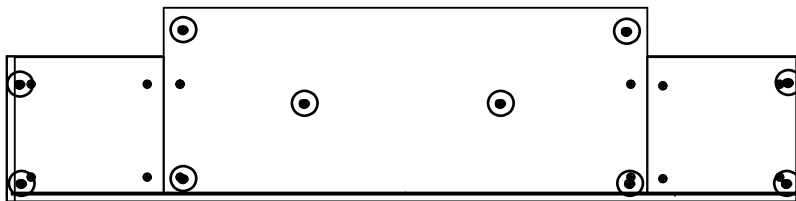
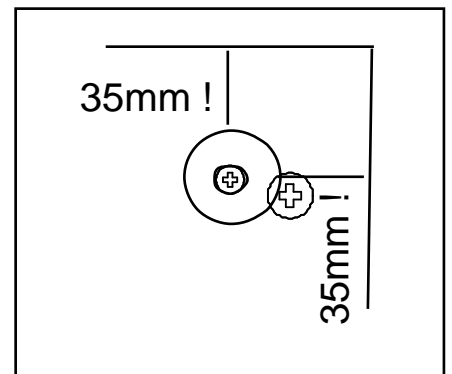
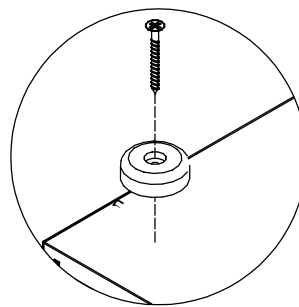
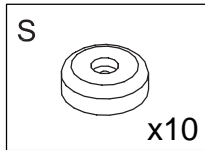
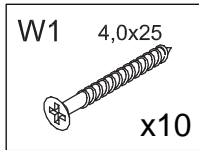

19

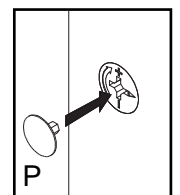
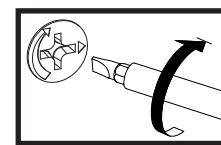
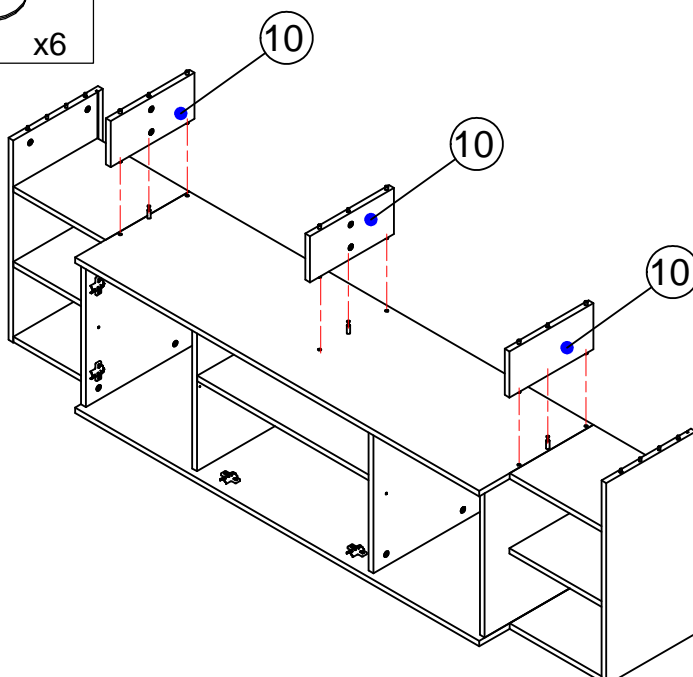
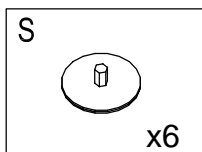

20

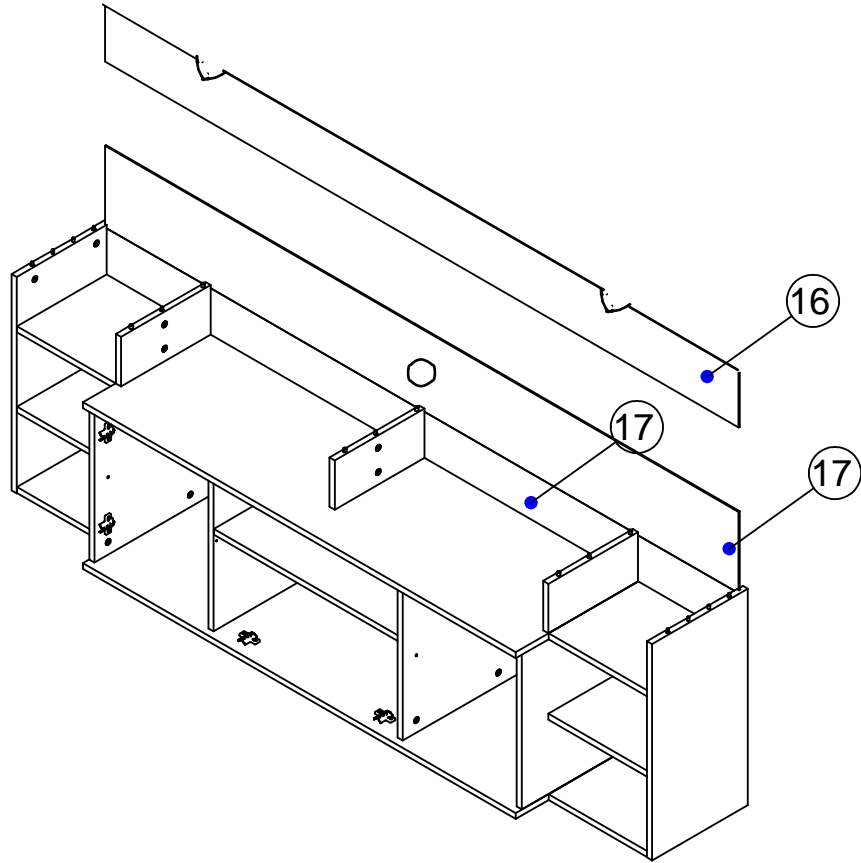

21

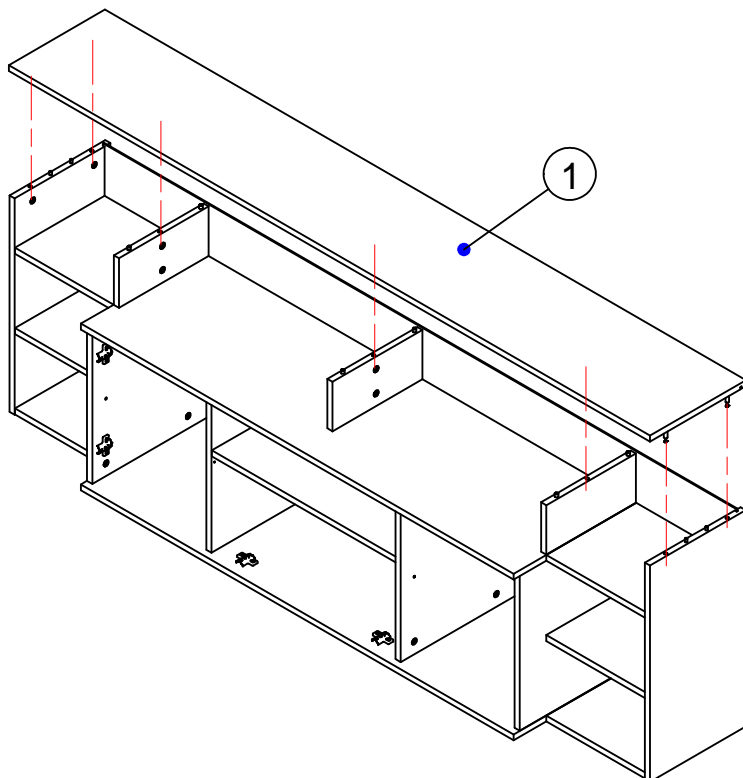
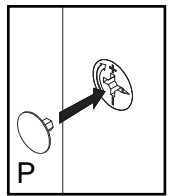
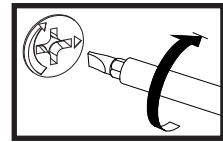
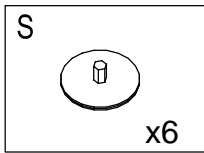

22

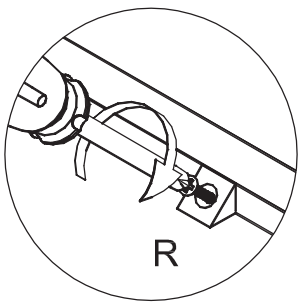
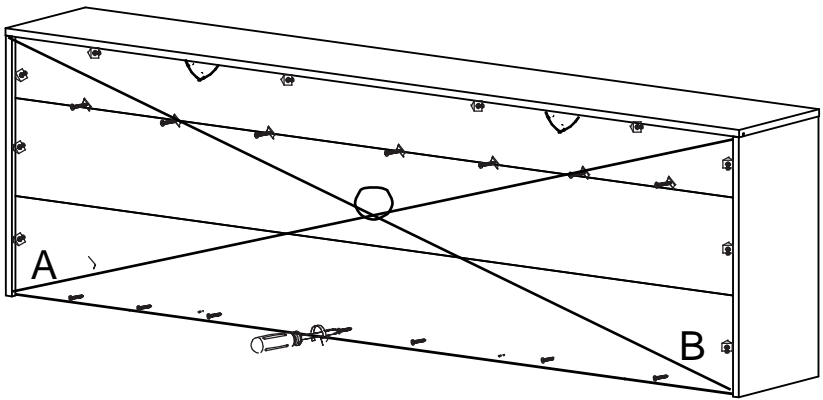
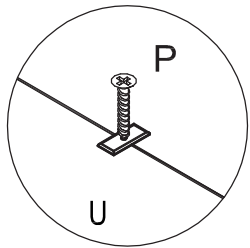
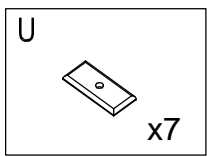
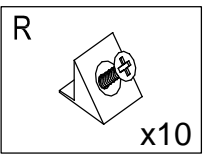
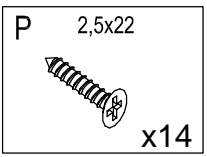

!
A=B

23

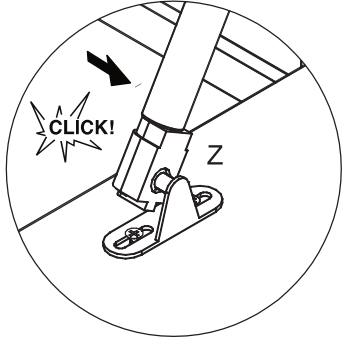
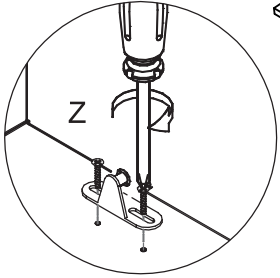
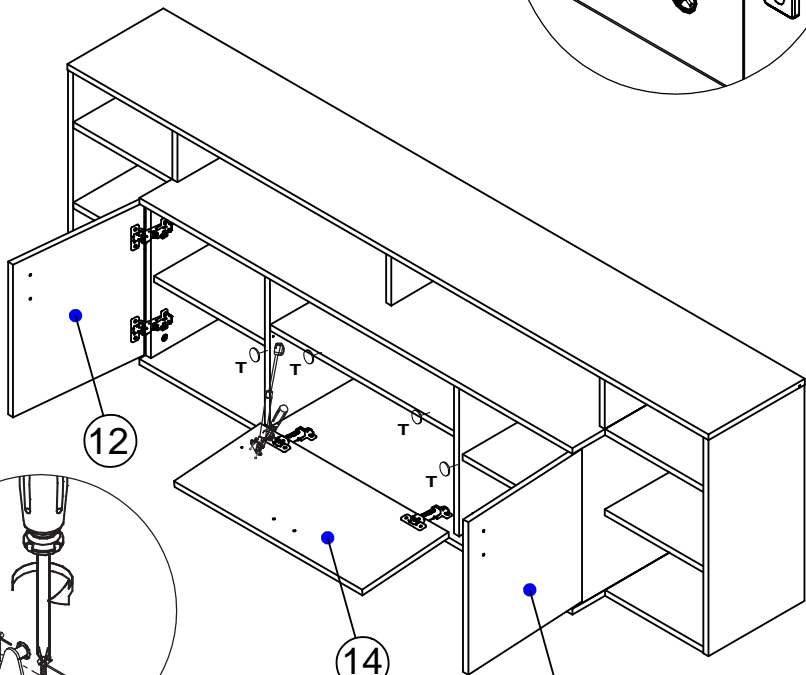
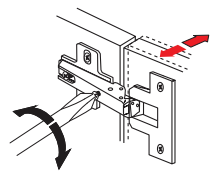
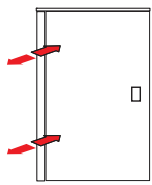
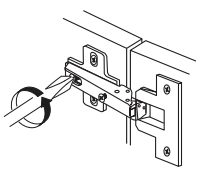
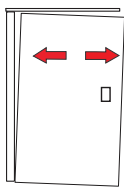
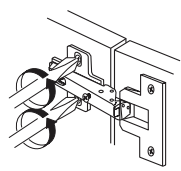
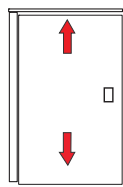
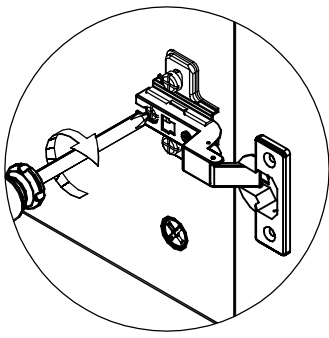
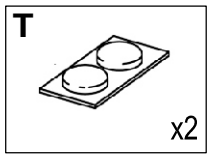
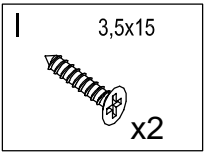

24

