

Sc 290

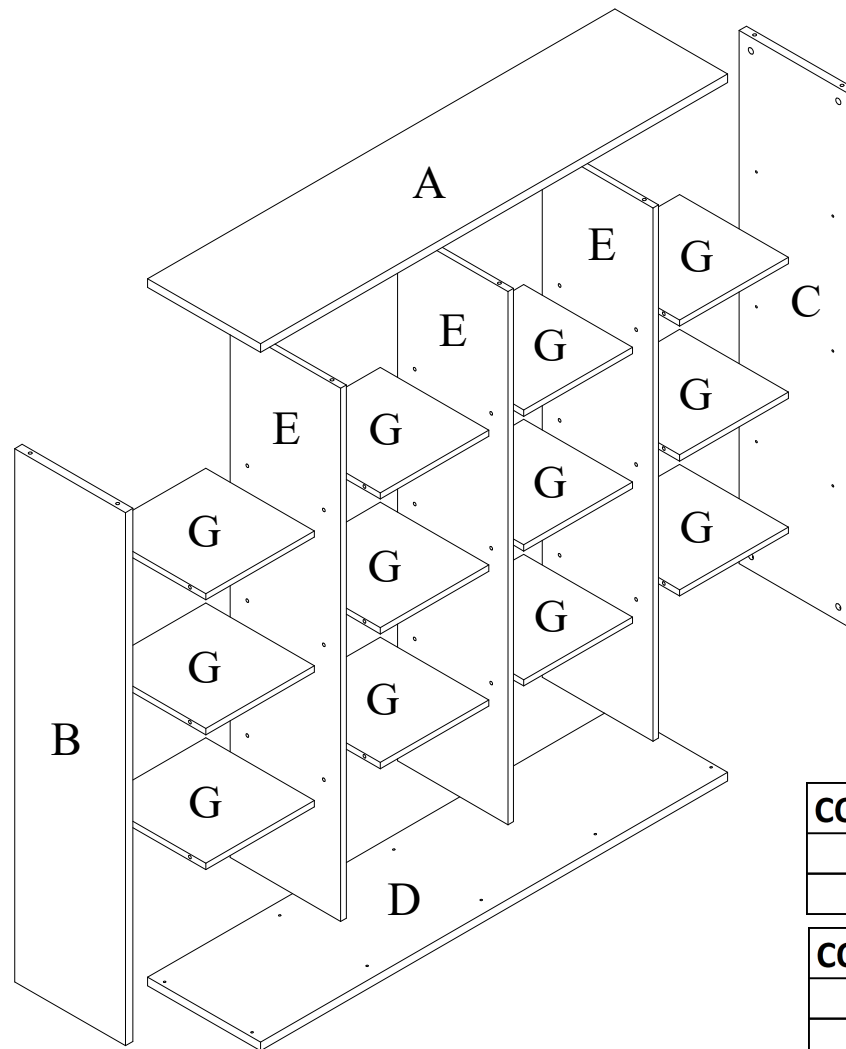

COLLI 1/2				
A+D	1368	x	330	2
G	318	x	318	12
COLLI 2/2				
B+C	1352	x	324	2
E	1352	x	324	3

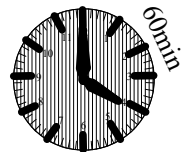
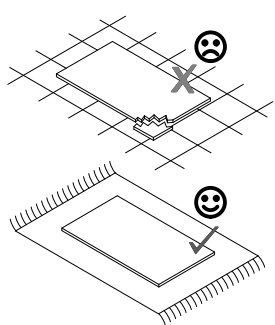
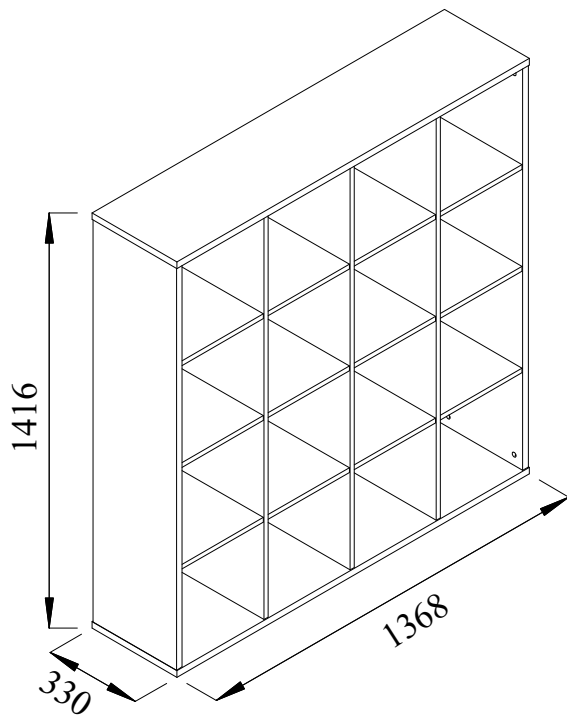

0013K	1x	0019K	32x	0018K	68x	0074K	18x	0054K	68x	0061K	7x
-------	----	-------	-----	-------	-----	-------	-----	-------	-----	-------	----

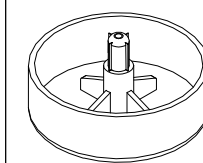
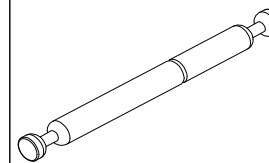
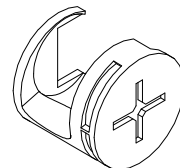
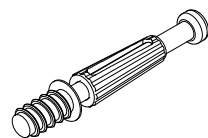
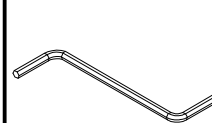

0109K	2x	0051K	2x	0001V	2x	0013V	2x
-------	----	-------	----	-------	----	-------	----

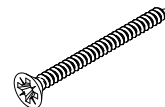
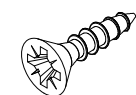
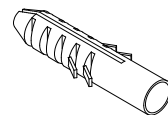
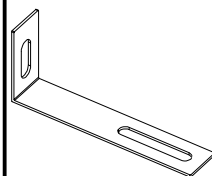

4x16

5x50

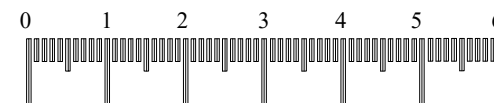

1)

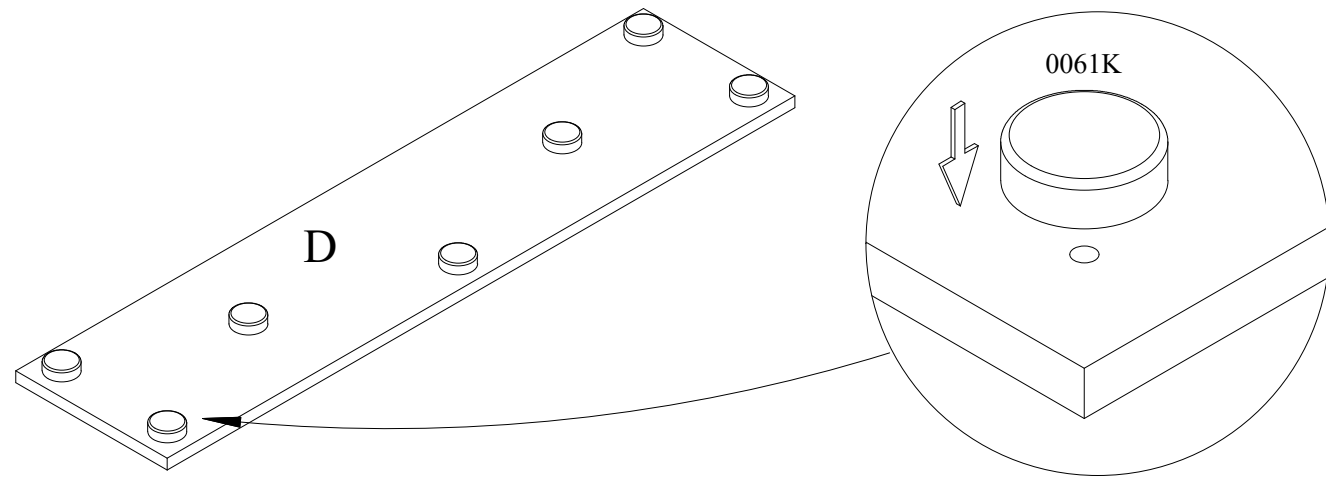

0061K	7x

2)

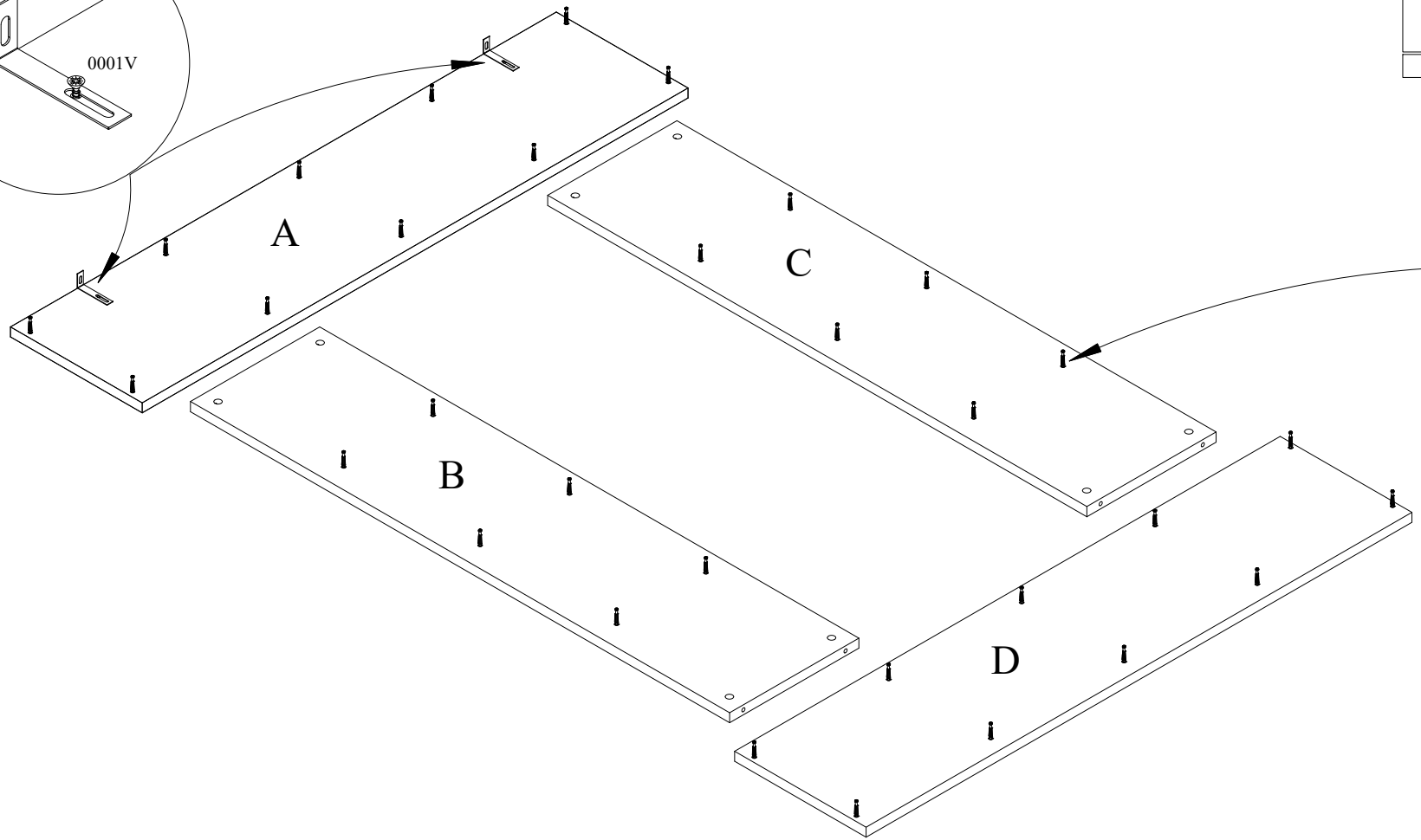
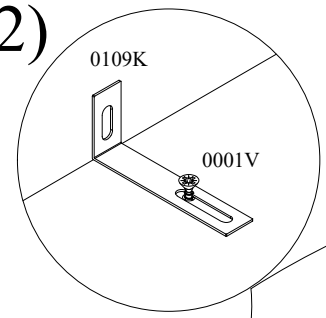

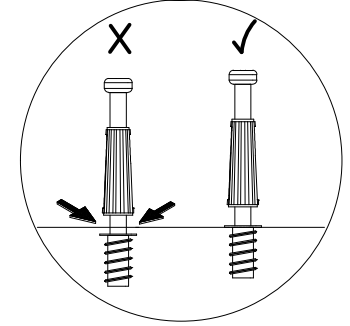
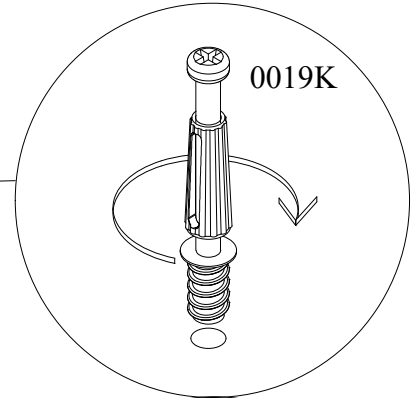

0001V	2x	0109K	2x	0019K	32x
4x16					

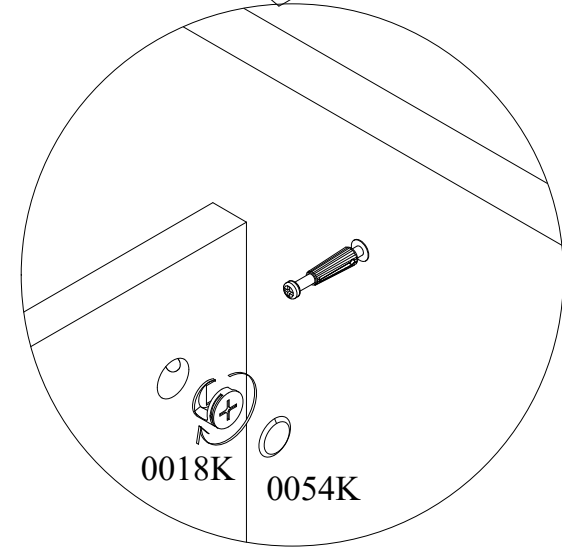
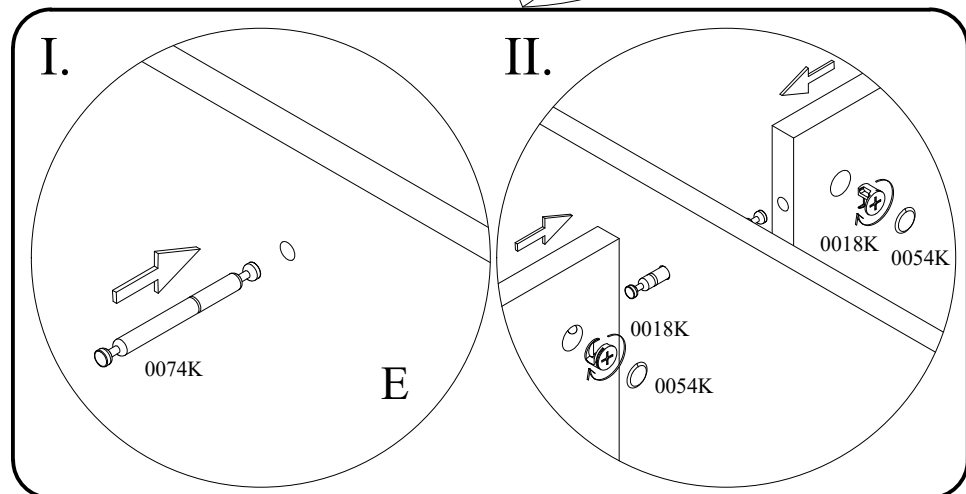
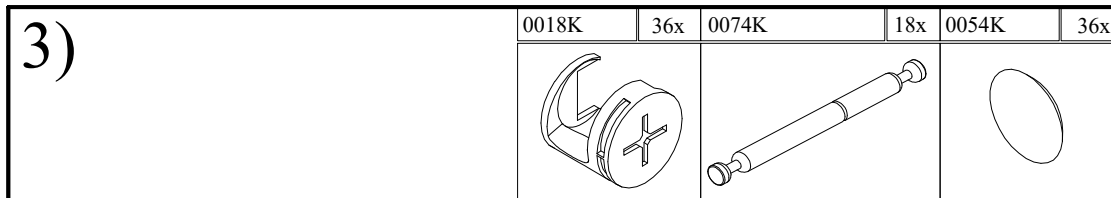

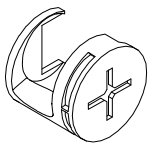

5)

0018K	20x	0054K	20x
			

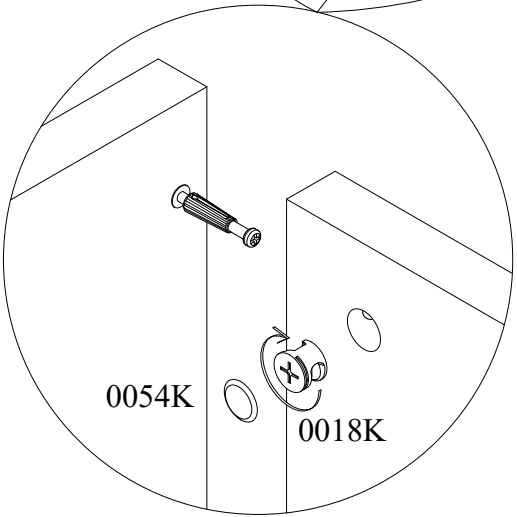
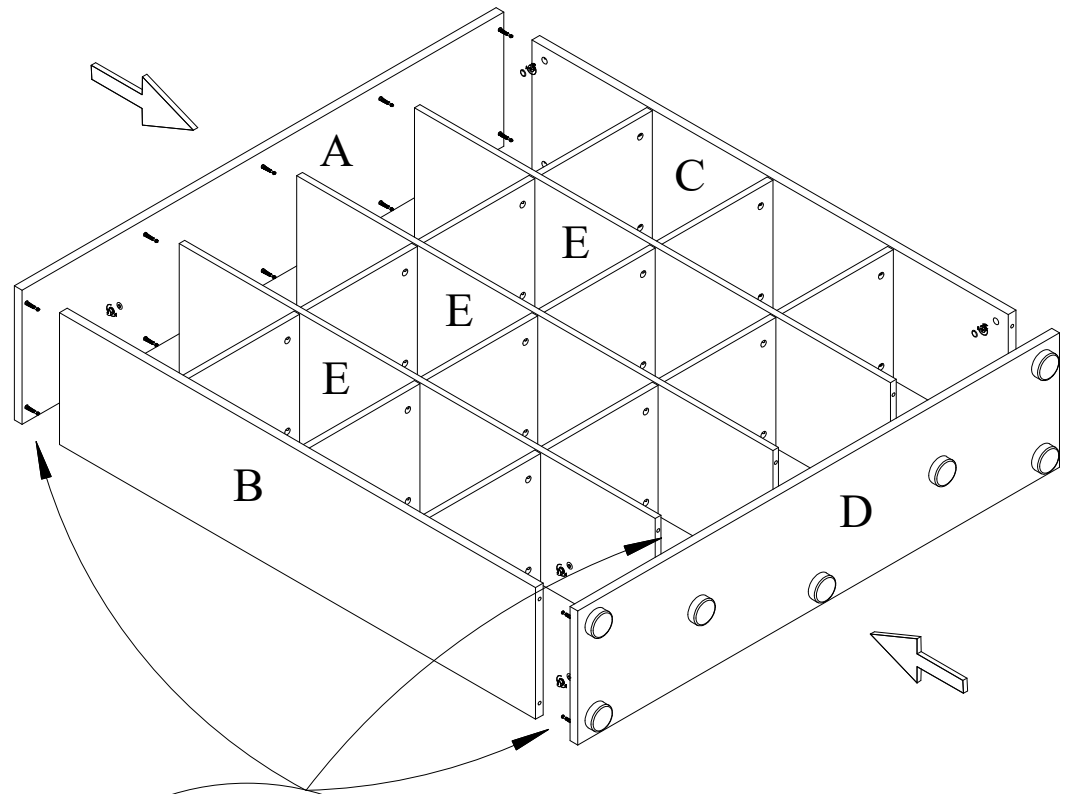

6)

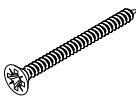
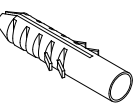
0013V	2x	0051K	2x
			
5x50			

