

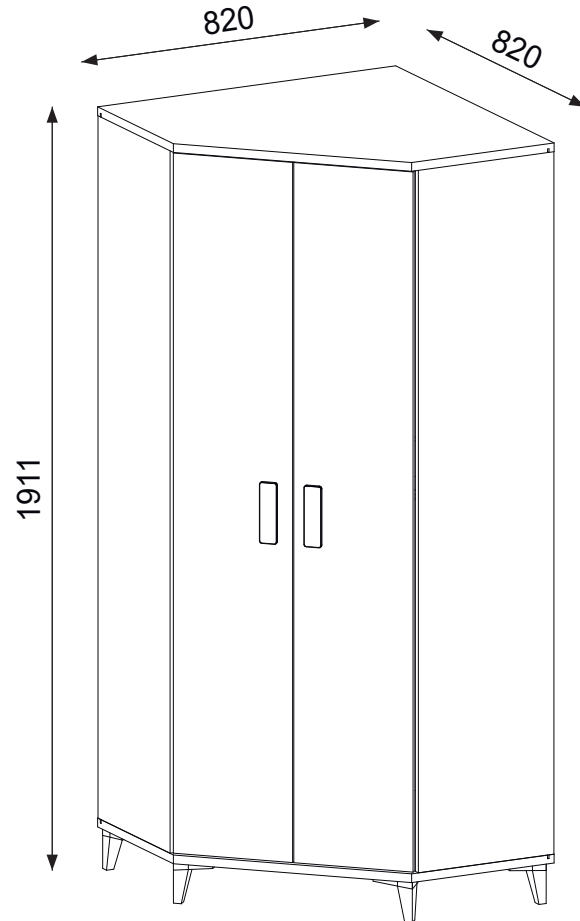

Modell **Kubo KB 06**

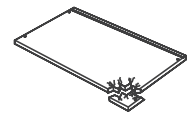

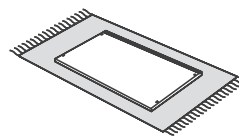

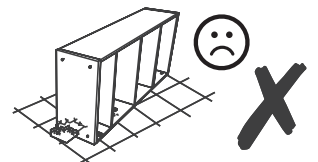
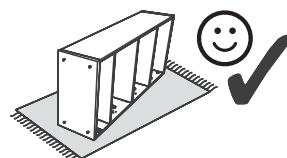
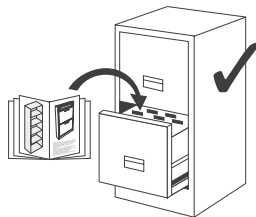
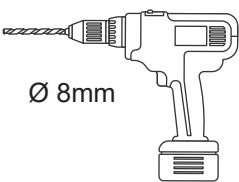
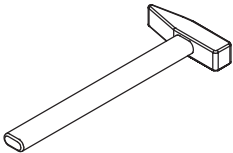
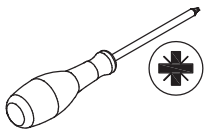
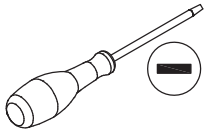
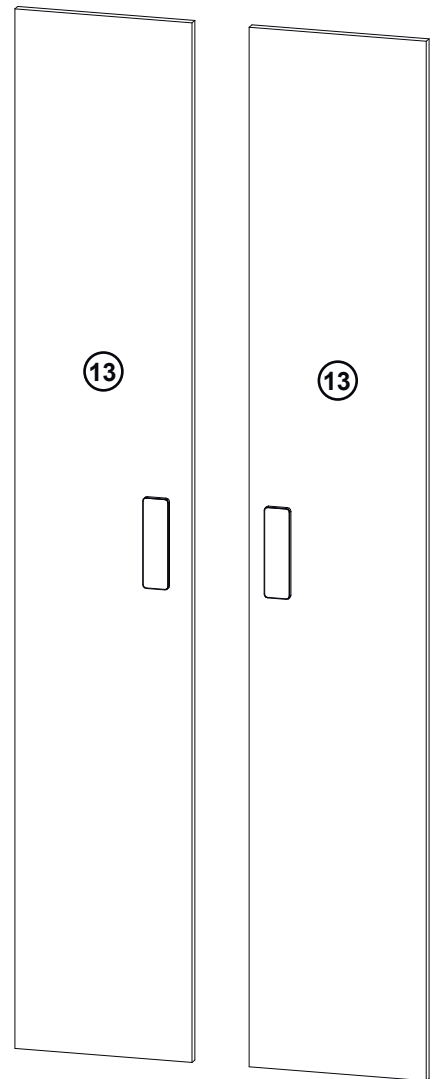
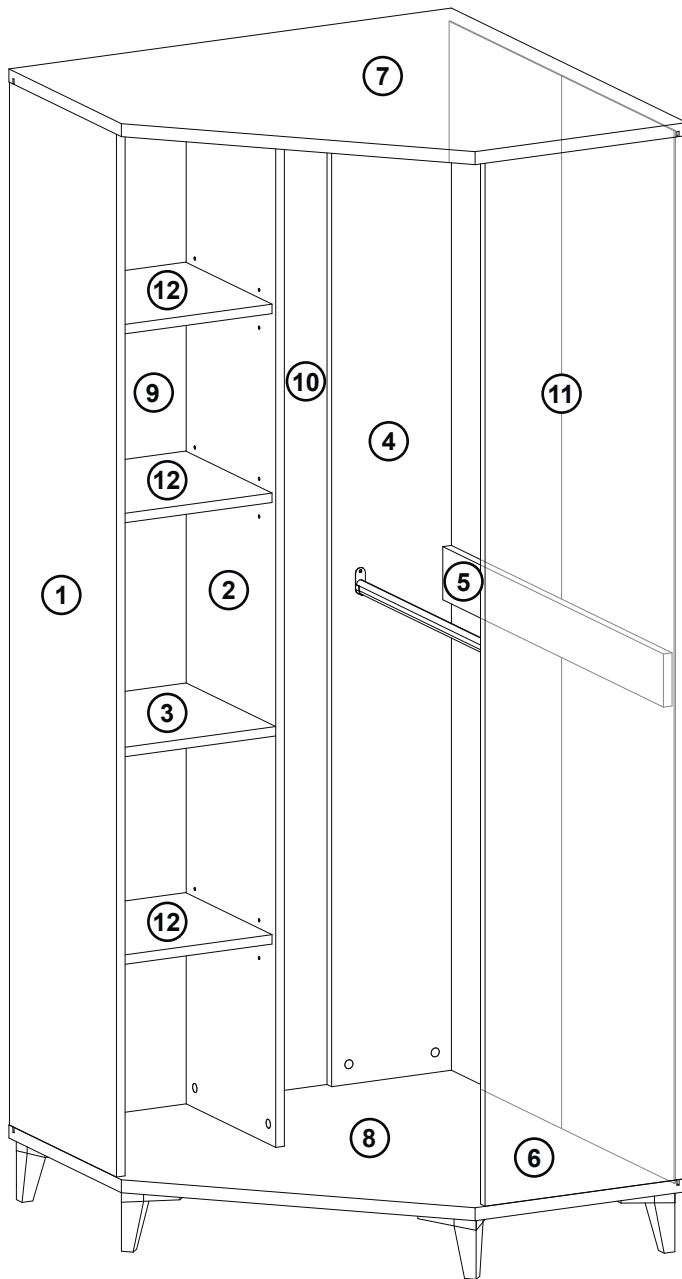
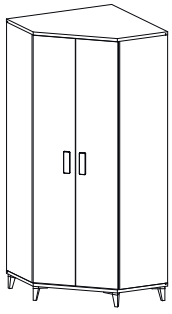

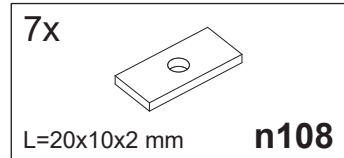
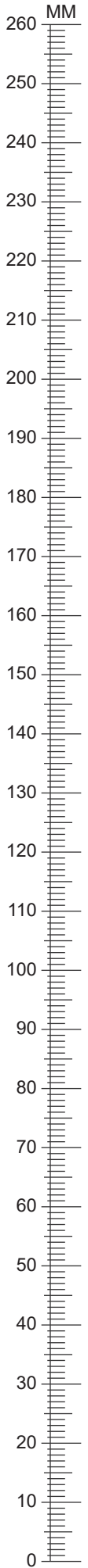
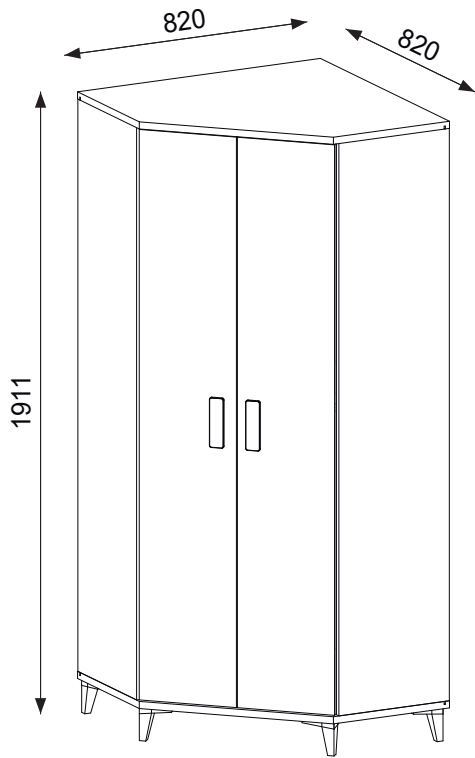





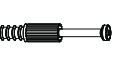

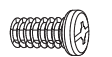
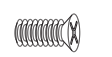

A	B (mm)			C	D
1	1767	373	16	x1	3/4
2	1767	312	16	x1	3/4
3	302	312	16	x1	1/4
4	1767	240	16	x1	2/4
5	769	90	16	x1	1/4
6	1767	373	16	x1	3/4
7	820	820	22	x1	1/4
8	820	820	22	x1	1/4
9	1783	318	2,5	x1	3/4
10	1783	282	2,5	x1	3/4
11	1783	784	2,5	x1	3/4
12	301	301	16	x3	1/4
13	1761	303	16	x2	2/4

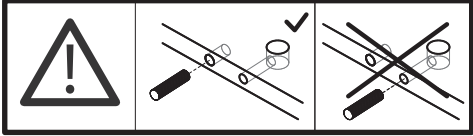
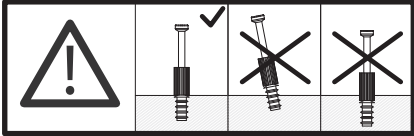
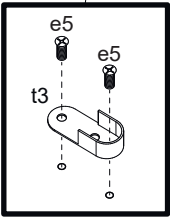
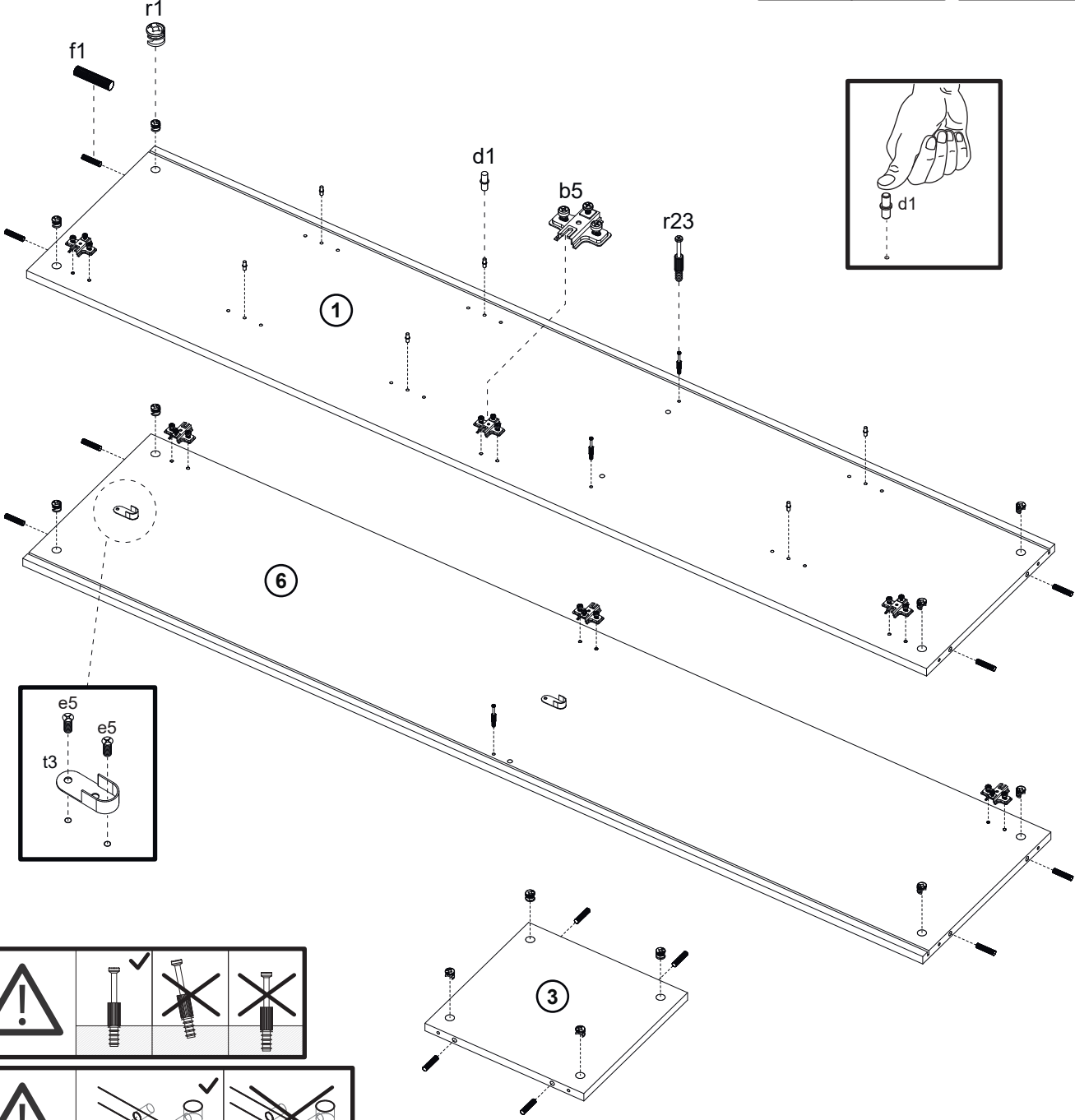
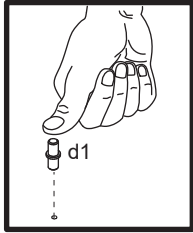
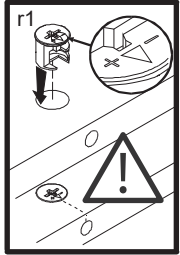
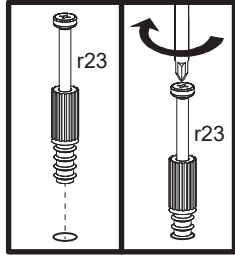
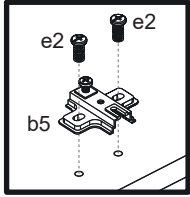
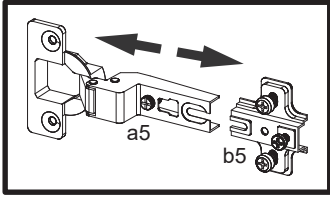
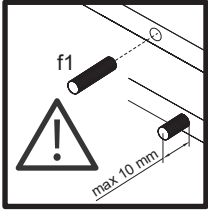

<p>2x L=762x23x15mm t1</p>	<p>4x 30x15mm t3</p>	<p>22x Ø 8x30mm f1</p>
<p>22x 45mm r23</p>	<p>22x Ø 15x12mm r1</p>	<p>20x Ø 20mm s1</p>
<p>6x Ø 35mm ab5</p>	<p>2x 154x44x24mm k3</p>	<p>22x 10x10x15mm l2</p>
<p>1x L=75x25x15mm n14/2</p>	<p>12x Ø 6,3x13 mm e2</p>	<p>20x Ø 4x20mm p27</p>
<p>4x h=100mm k49</p>	<p>4x Ø 4x25mm p26</p>	<p>7x Ø 2x20mm g1</p>
<p>1x h=100mm k50</p>	<p>14x Ø 3,5x16mm p51</p>	<p>11x Ø 4,2x13mm p20</p>
<p>12x Ø 5mm d1</p>	<p>2x Ø 5mm d2</p>	<p>8x Ø 5x11 mm e5</p>

<h1>1</h1>	<p>f1 x 12</p>  <p>Ø 8x30mm</p>	<p>r1 x 12</p>  <p>Ø 15x12mm</p>	<p>r23 x 3</p>  <p>45mm</p>	<p>b5 x 6</p>  <p>40x50x12mm</p>	<p>e2 x 12</p>  <p>Ø 6,3x13mm</p>	<p>e5 x 4</p>  <p>Ø 5x11mm</p>	<p>t3 x 2</p>  <p>30x15mm</p>	<p>d1 x 6</p>  <p>Ø 5mm</p>
------------	--	---	--	---	---	---	--	--



<h1>2</h1>	<p>f1 x 10</p>  <p>Ø 8x30mm</p>	<p>r1 x 10</p>  <p>Ø 15x12mm</p>	<p>r23 x 3</p>  <p>45mm</p>	<p>e5 x 4</p>  <p>Ø 5x11mm</p>	<p>t3 x 2</p>  <p>30x15mm</p>	<p>d1 x 6</p>  <p>Ø 5mm</p>
------------	--	---	--	---	--	--

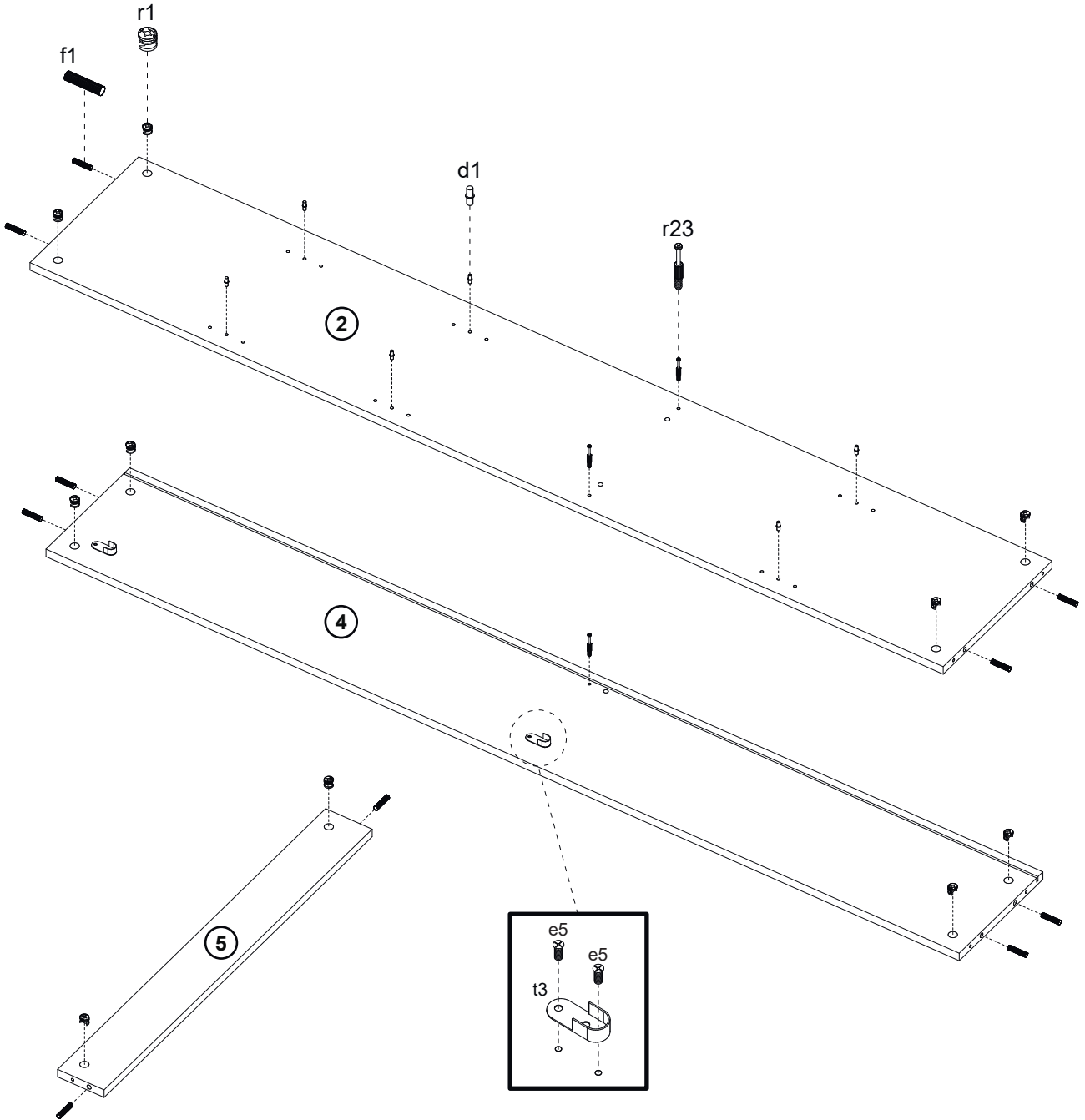
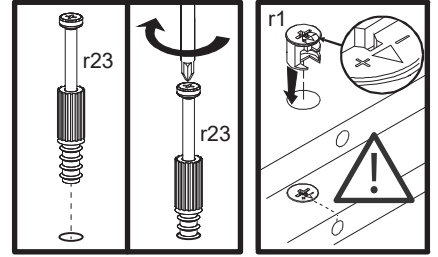
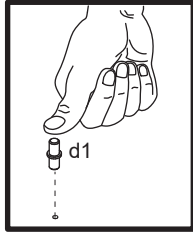
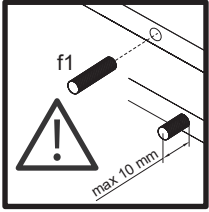

3

r23 x 16



45mm

d2 x 2



Ø 5mm

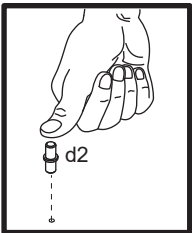
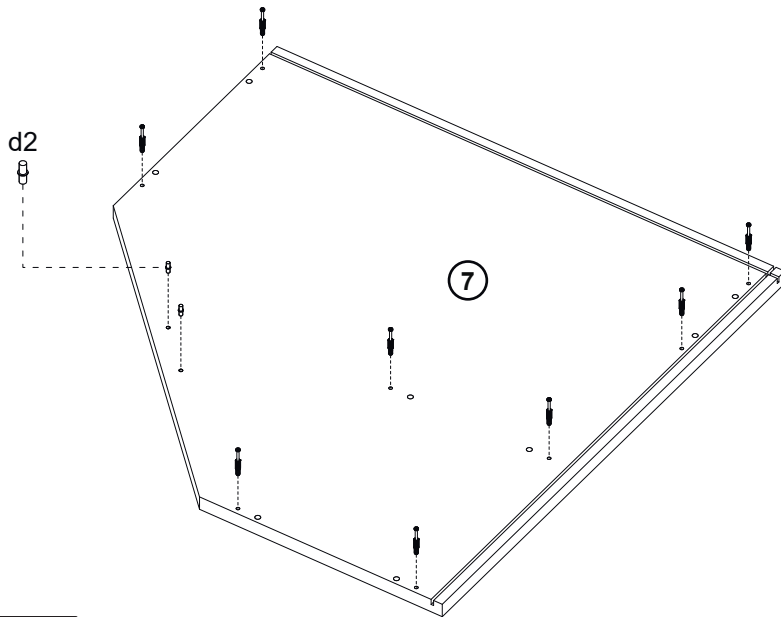
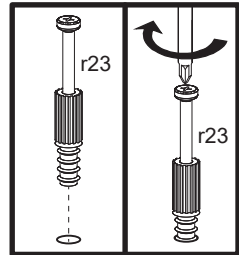
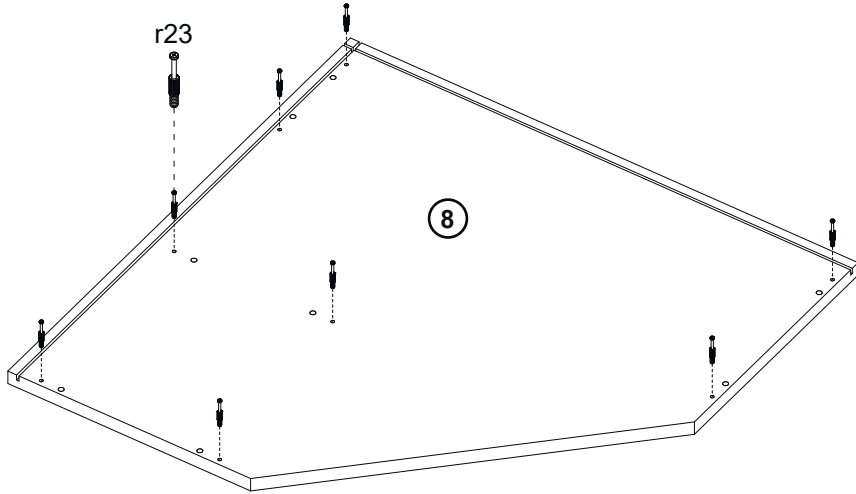

4

s1 x 4



Ø 20mm

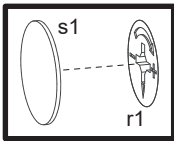
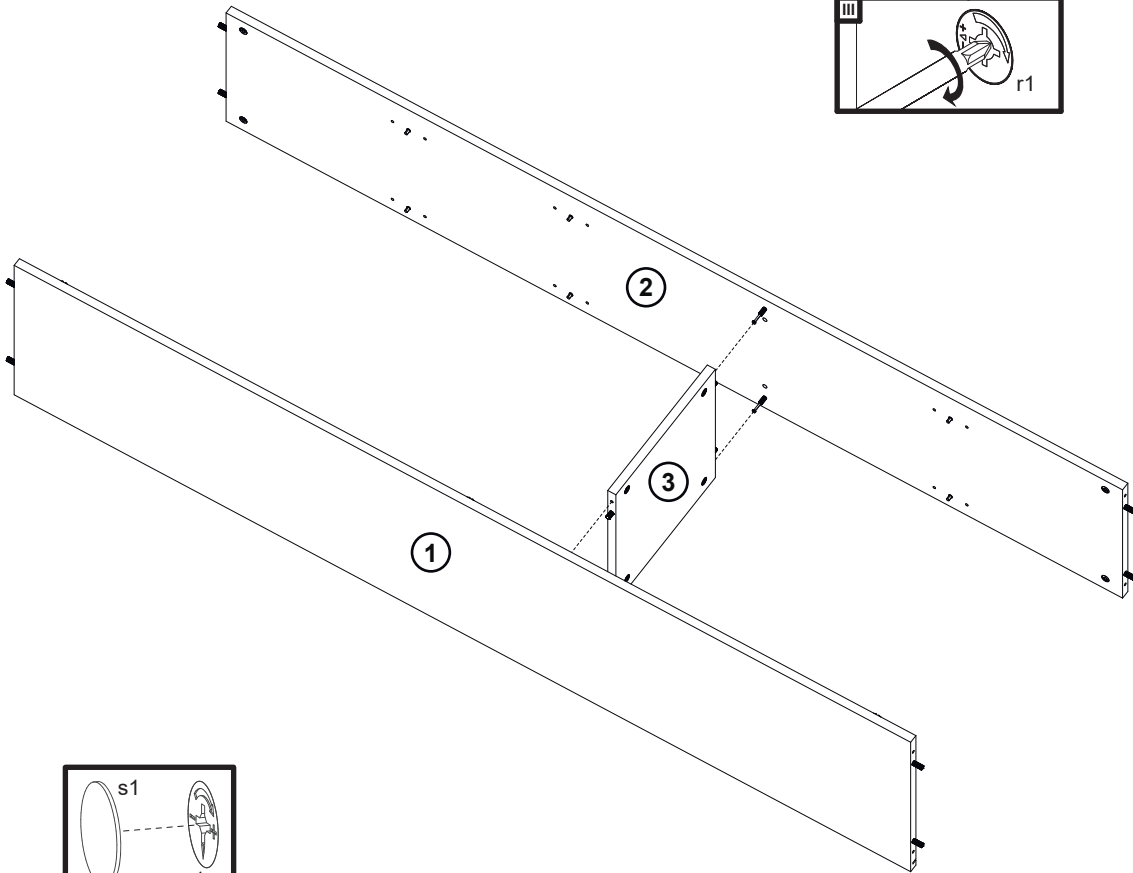
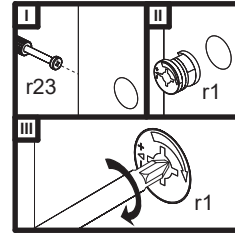

5

s1 x 4



Ø 20mm

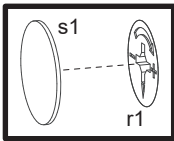
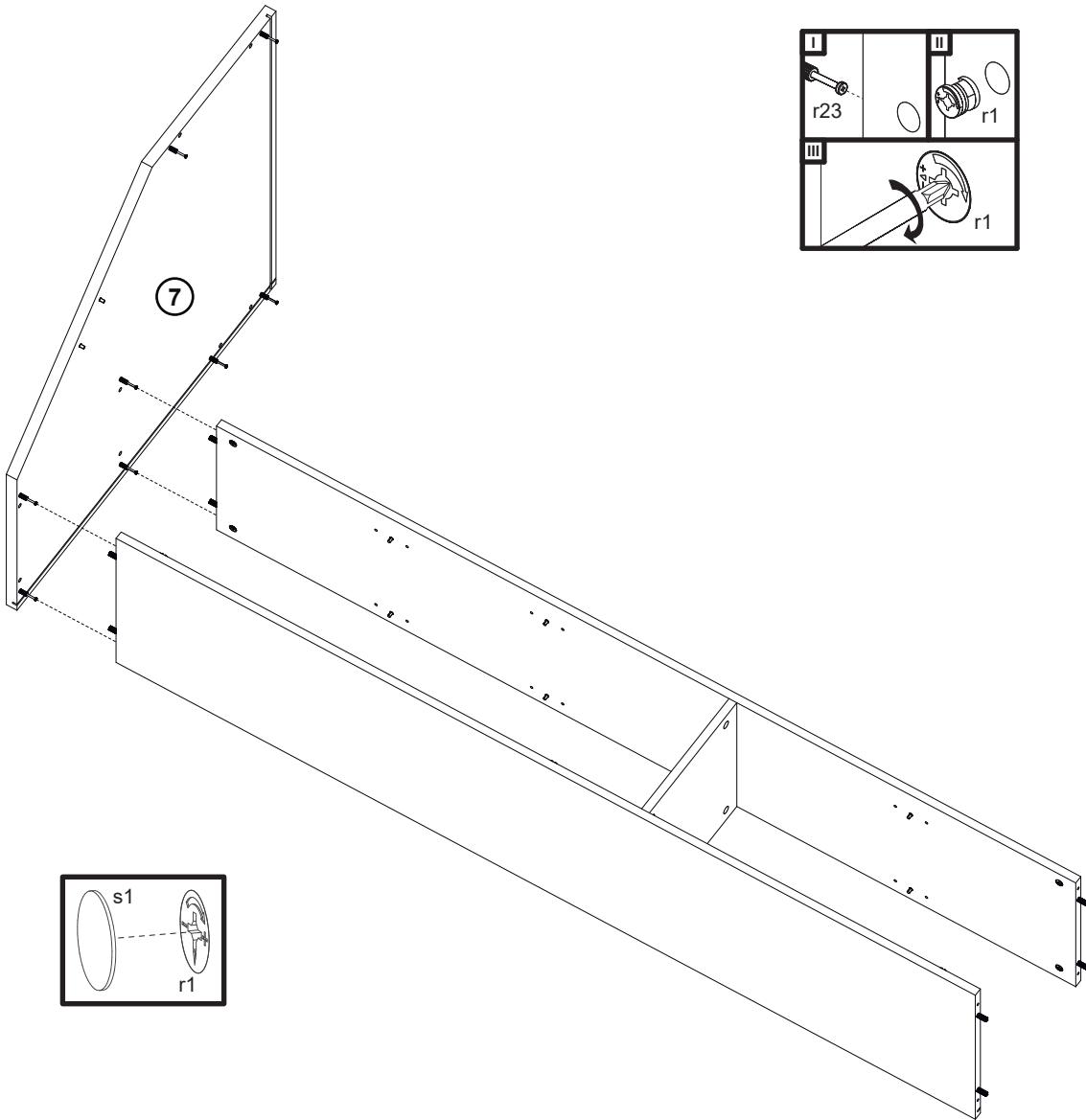

6

s1 x 2



Ø 20mm

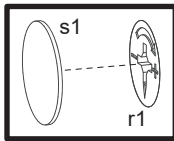
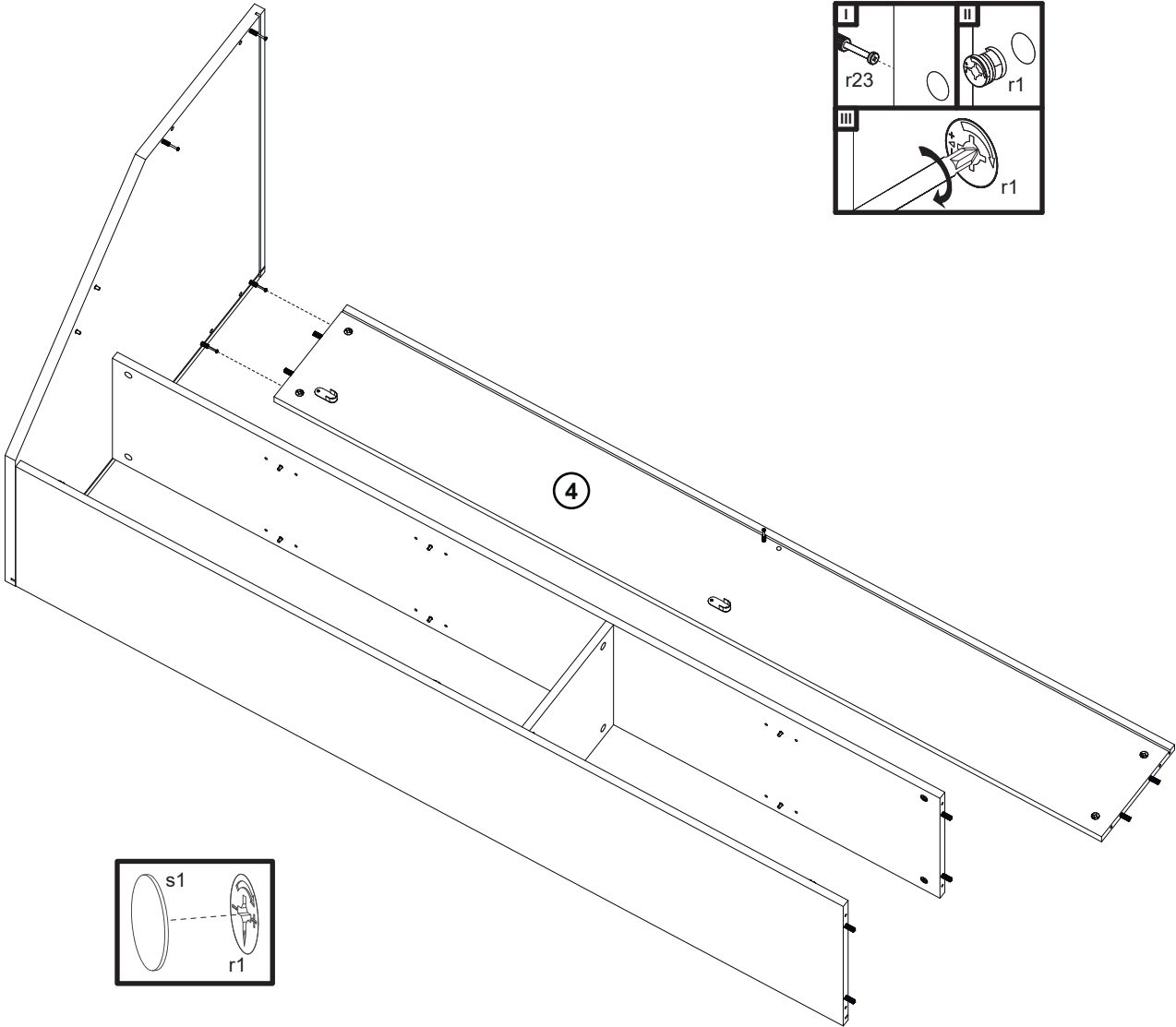
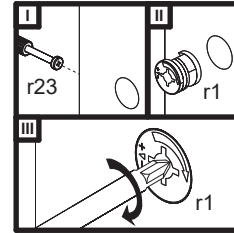

7

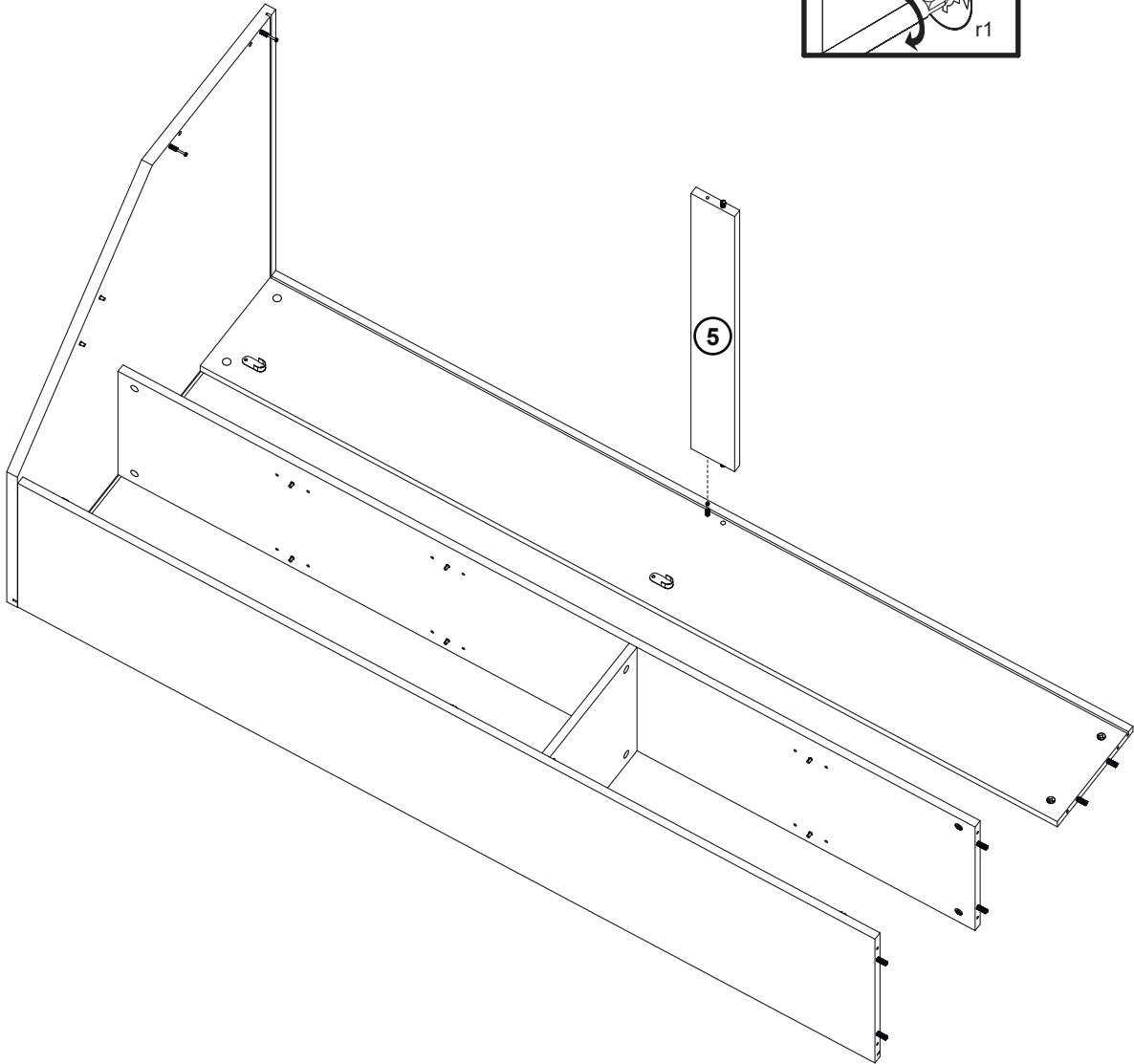
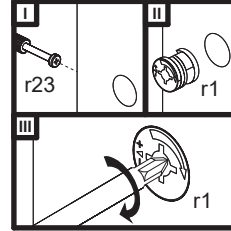

8

s1 x 2



Ø 20mm

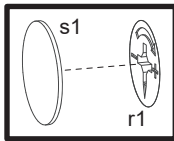
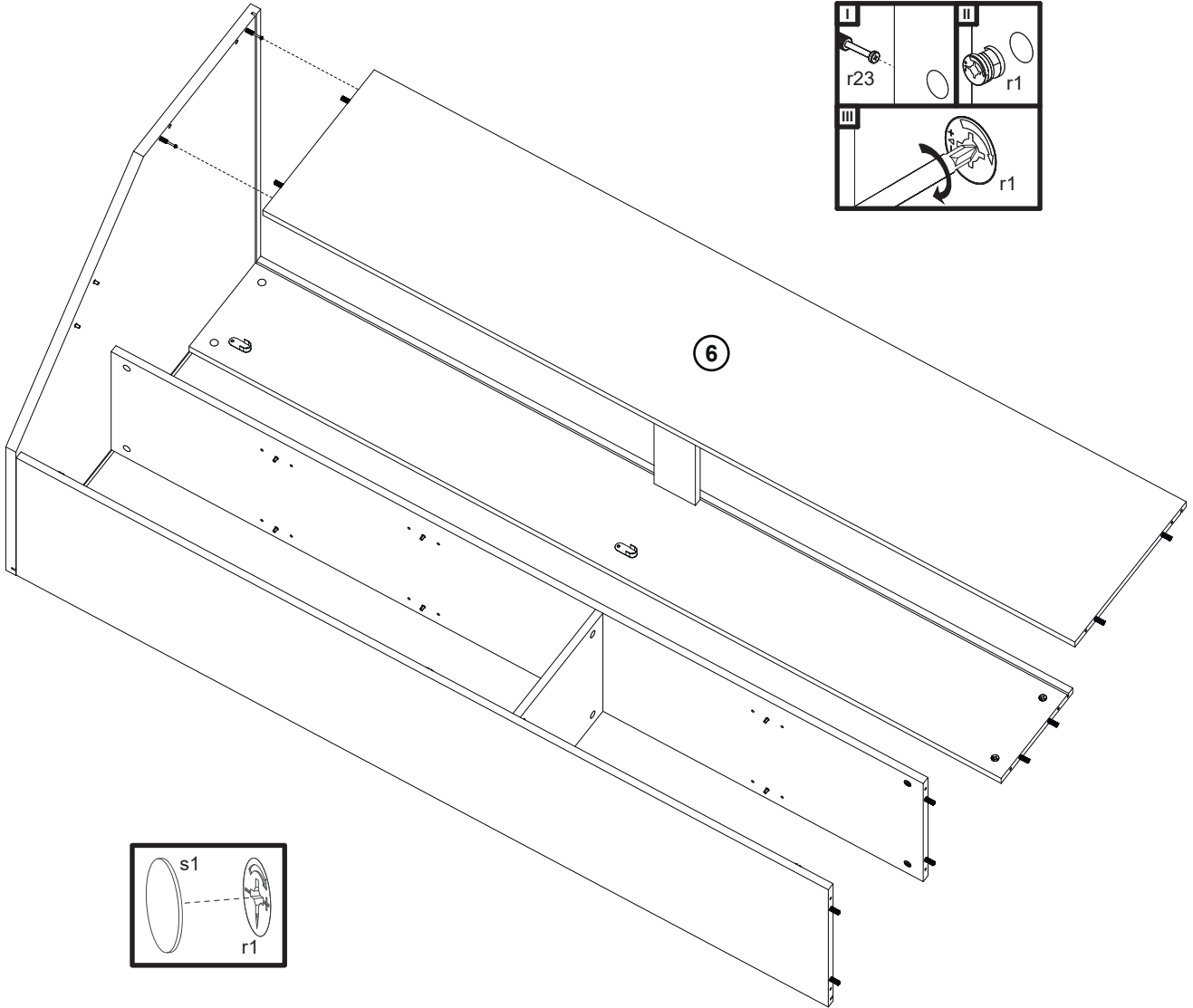
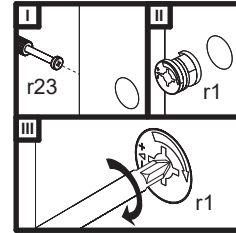

9

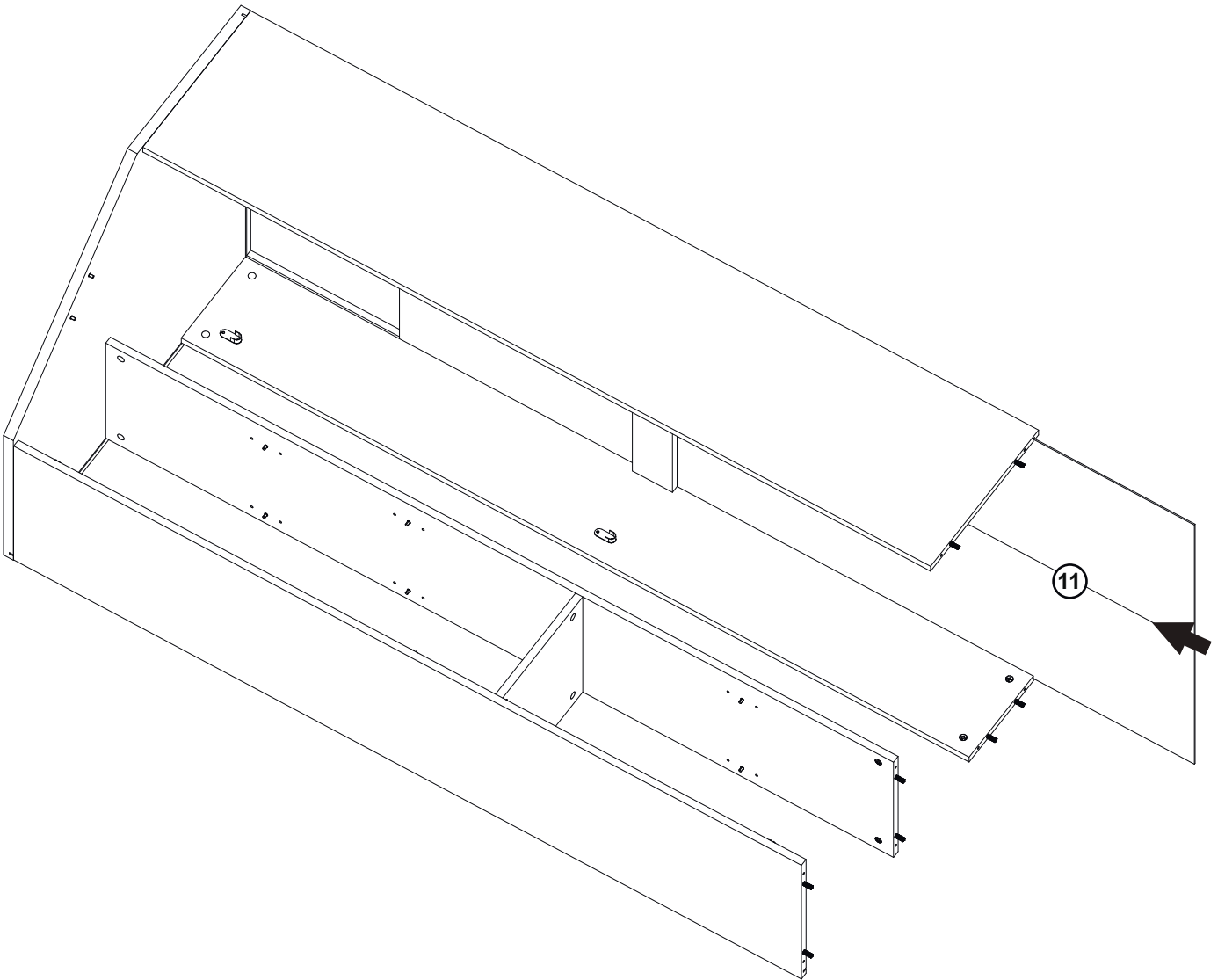

10

s1 x 8



Ø 20mm

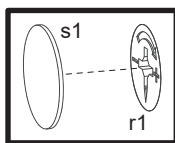
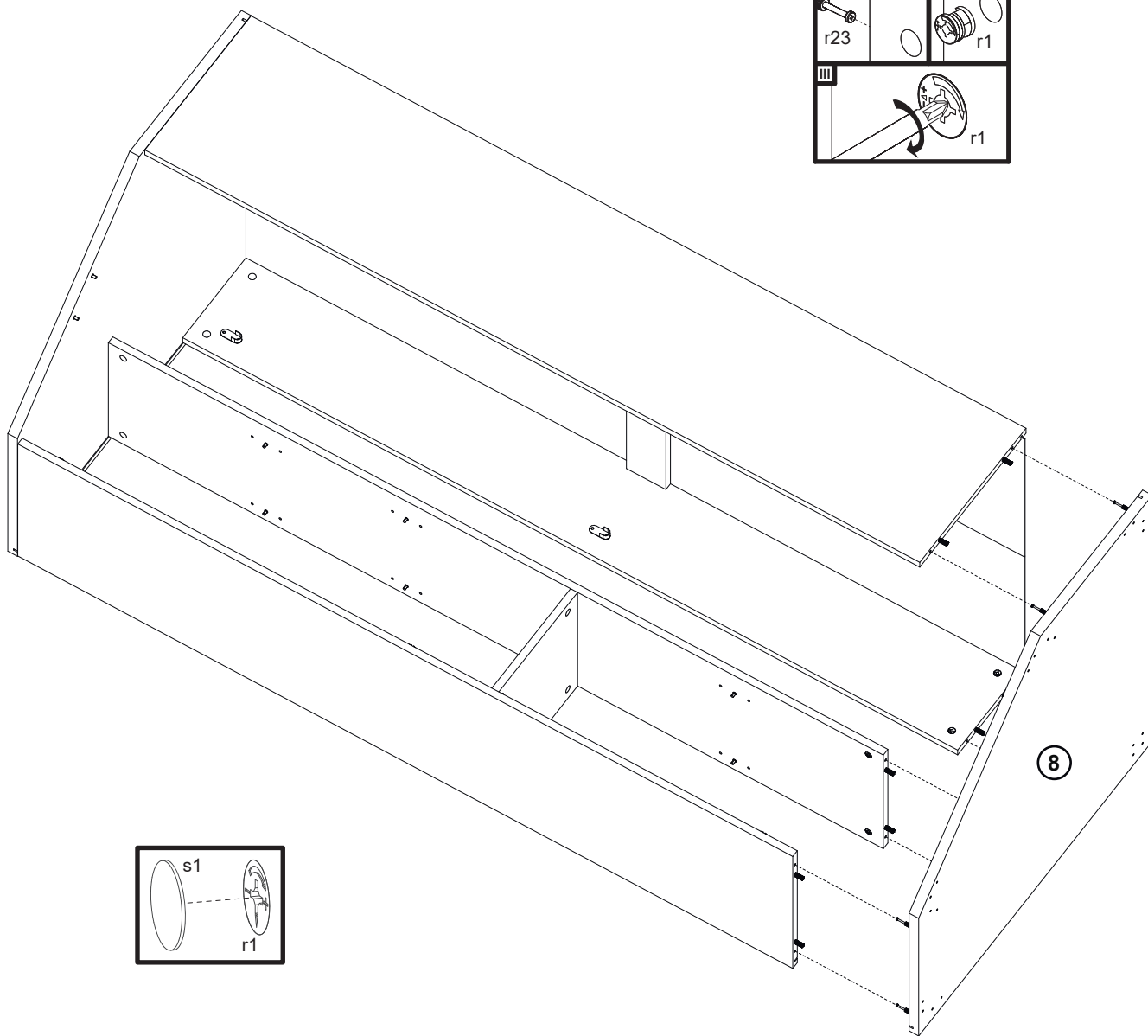
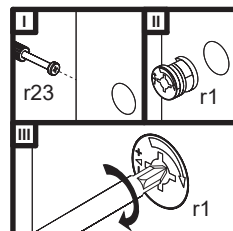

11

k49 x 4

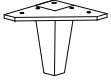

h=100mm

k50 x 1



h=100mm

p27 x 20



Ø 4x20mm

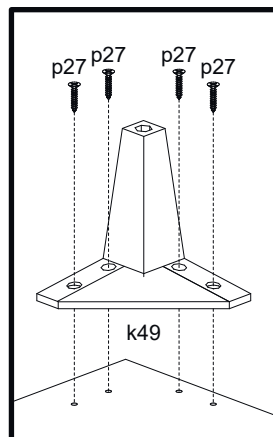
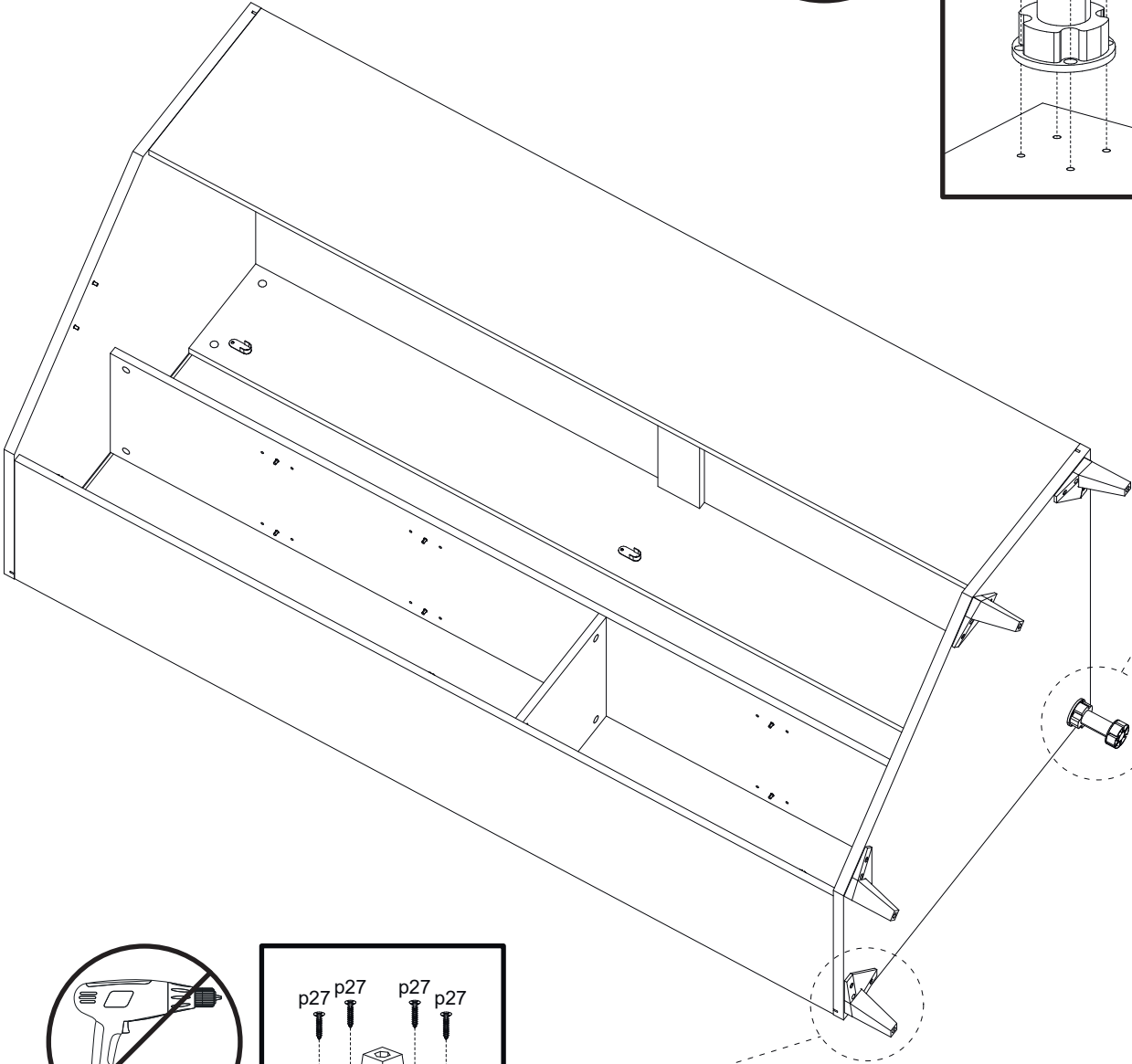
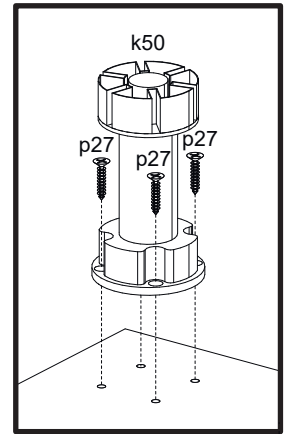
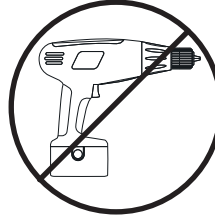

12

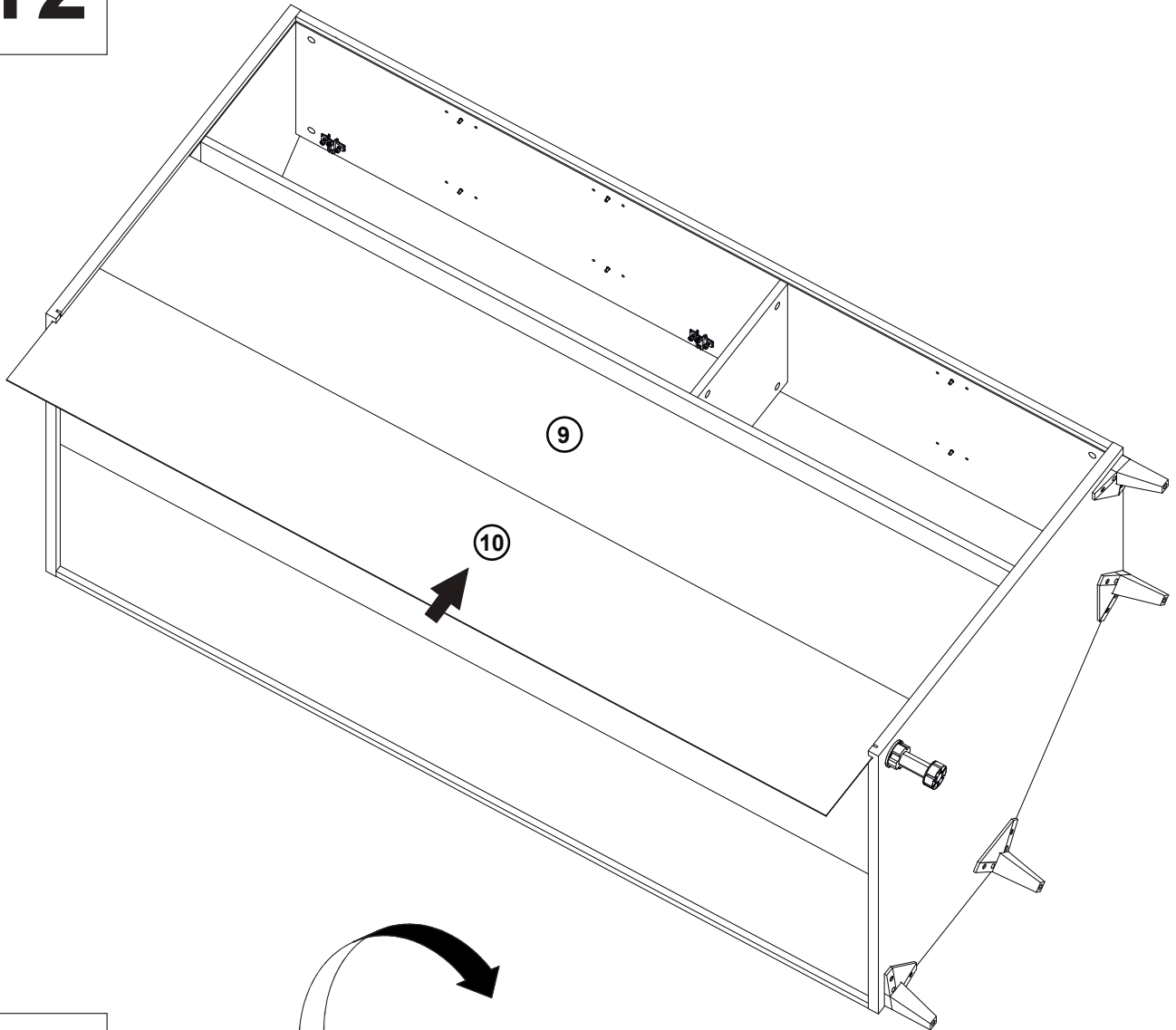

13

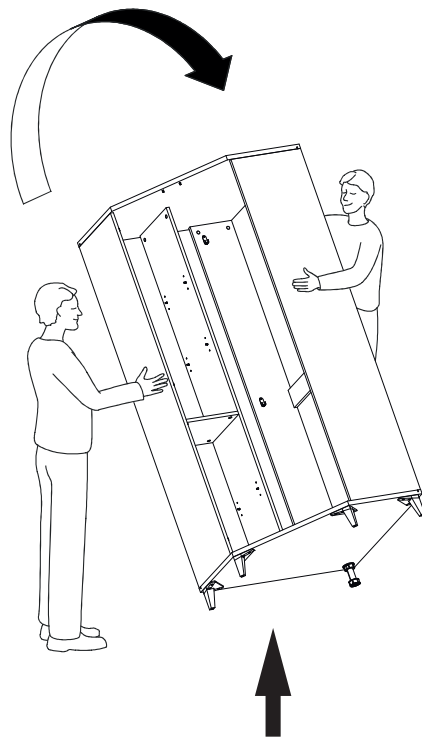

14

I2 x 22



10x10x15mm

g1 x 7



Ø 2x20mm

p20 x 11



Ø 4,2x13mm

n108 x 7

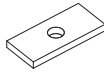

L=20x10x2mm

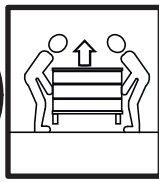
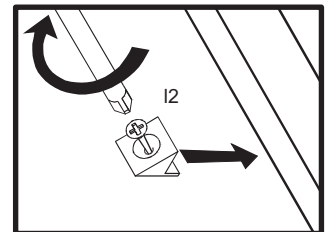
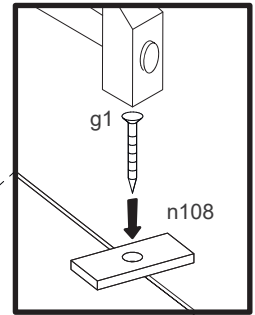
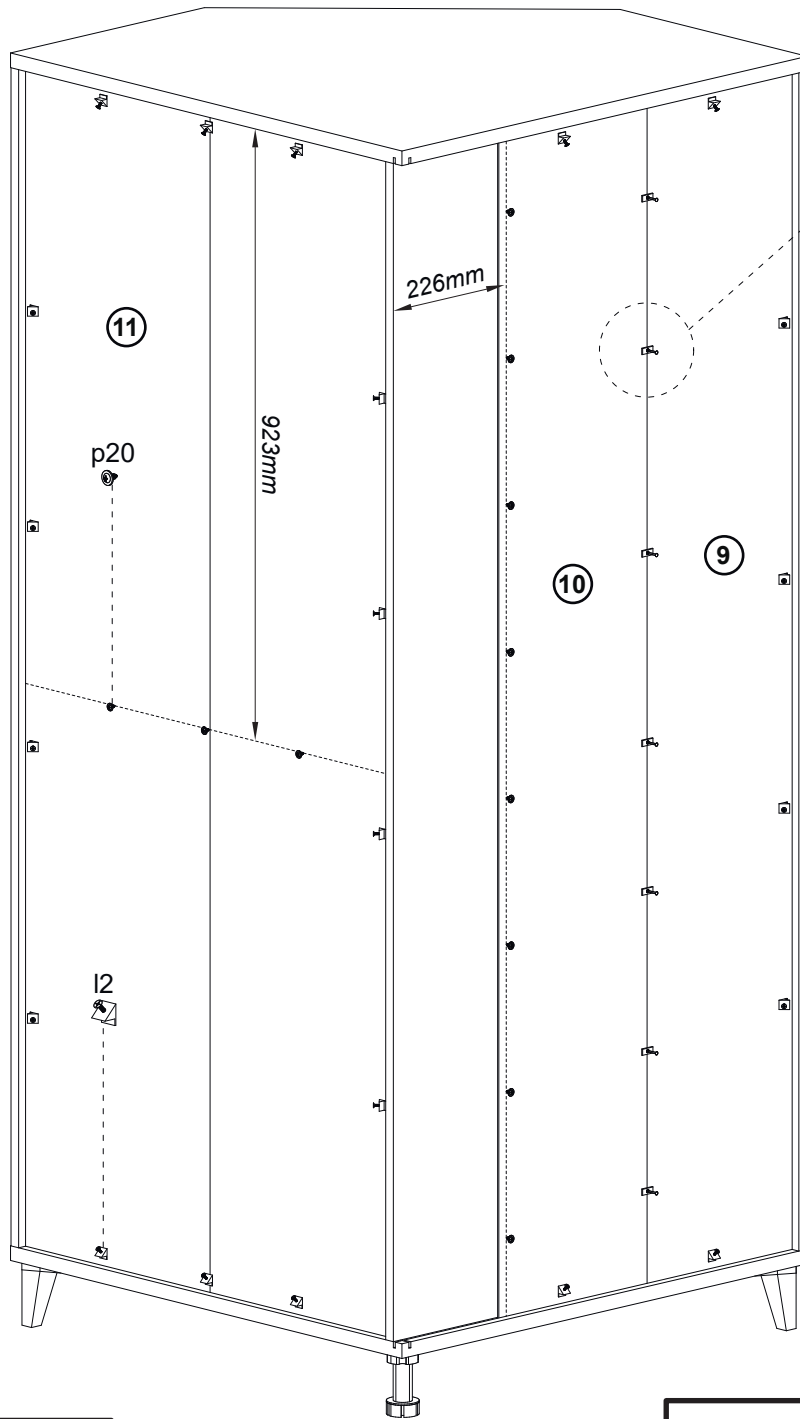

$XX=YY=90^\circ$

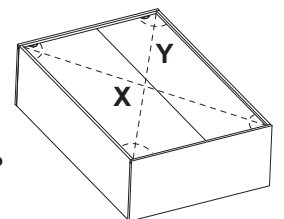

15

k3 x 2
154x44x24mm

p26 x 4
Ø 4x25mm

p51 x 12
Ø 3,5x16mm

a5 x 6
Ø 35mm

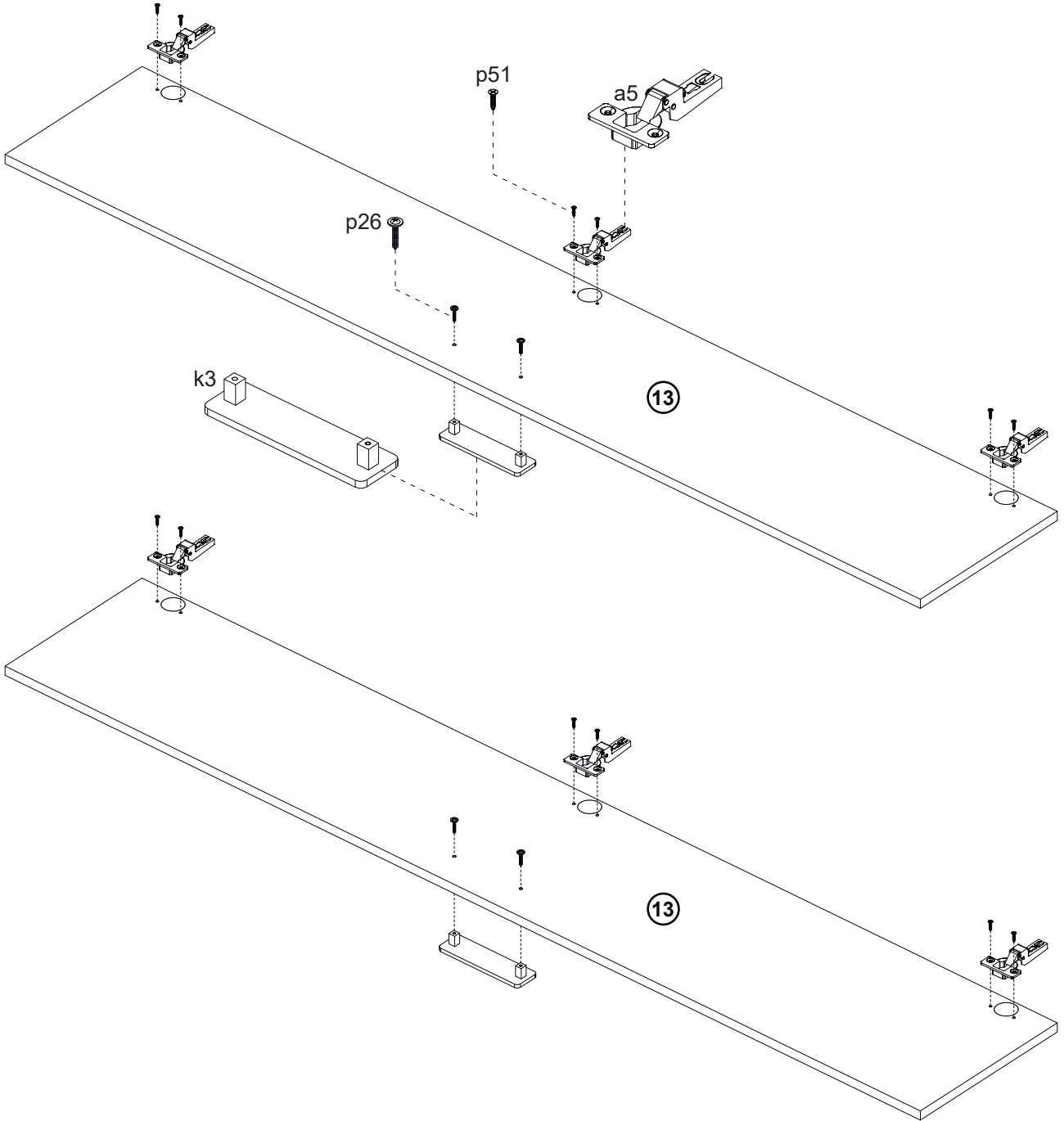

16



t1 x 2
L=762x23x15mm

n14/2 x 1
L=75x25x15mm

p51 x 2
Ø 3,5x16mm

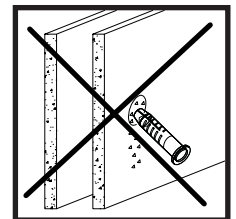
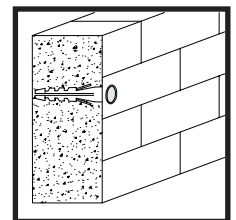
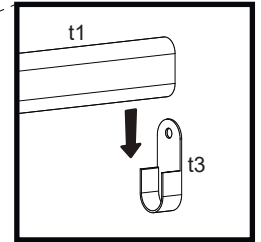
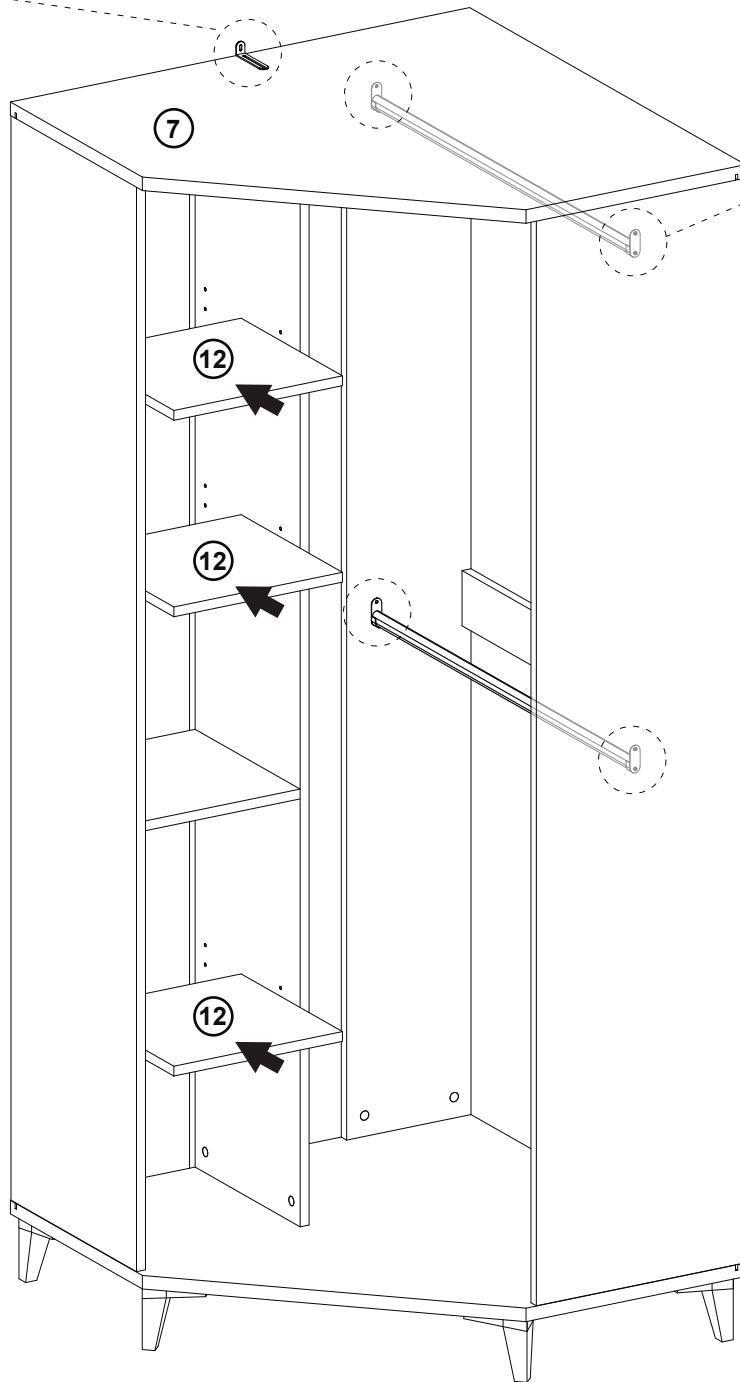
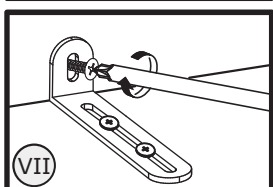
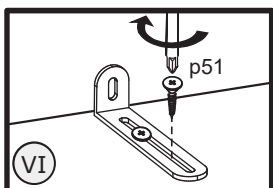
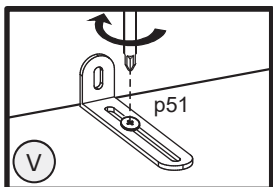
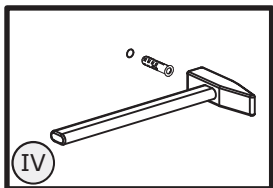
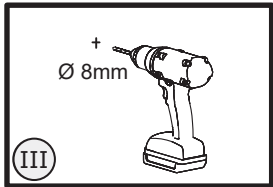
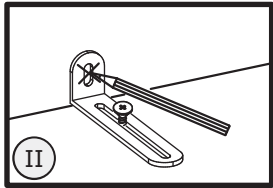
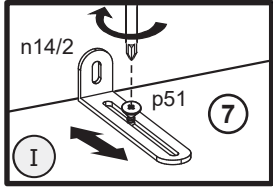

17

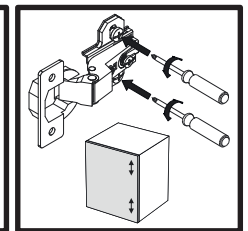
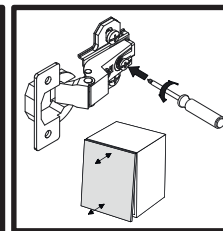
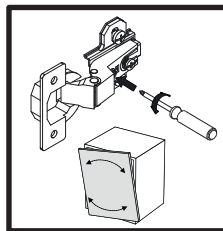
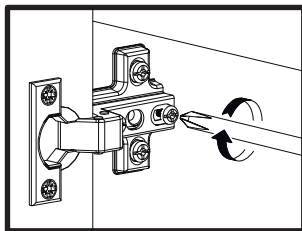
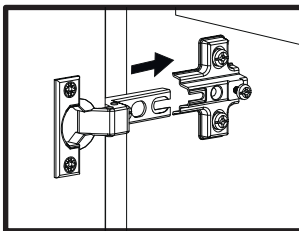
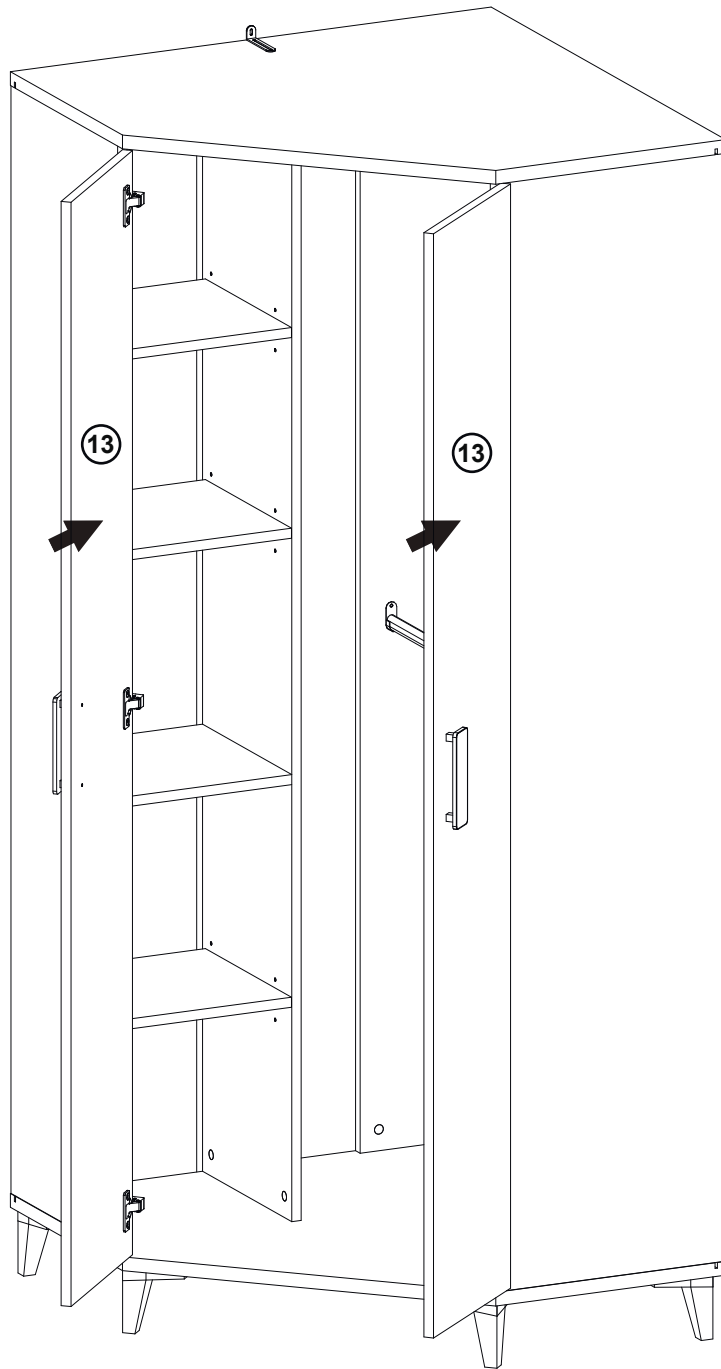

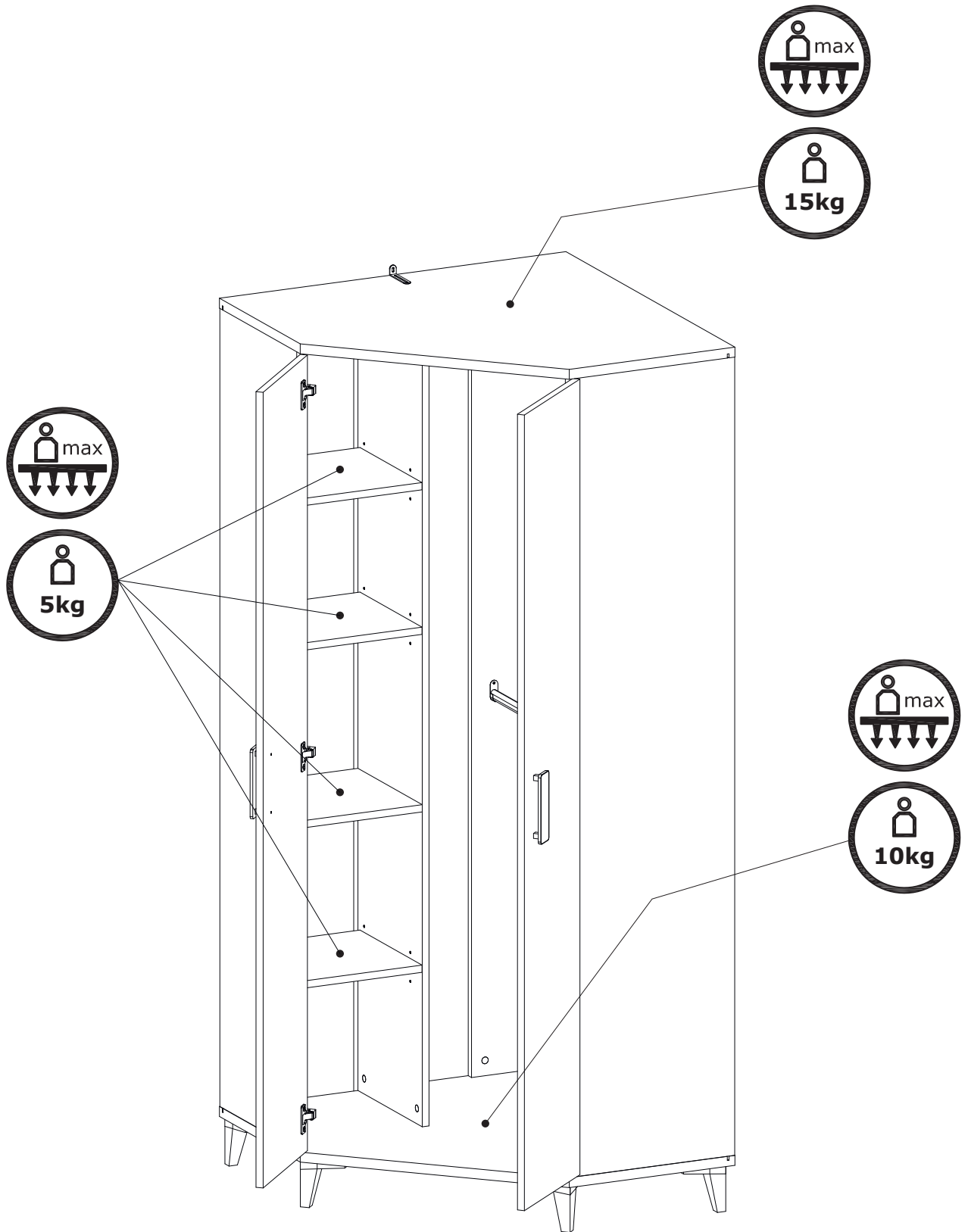

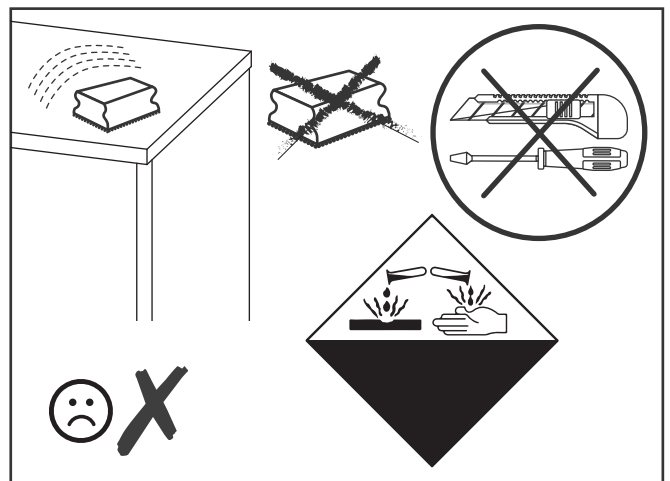
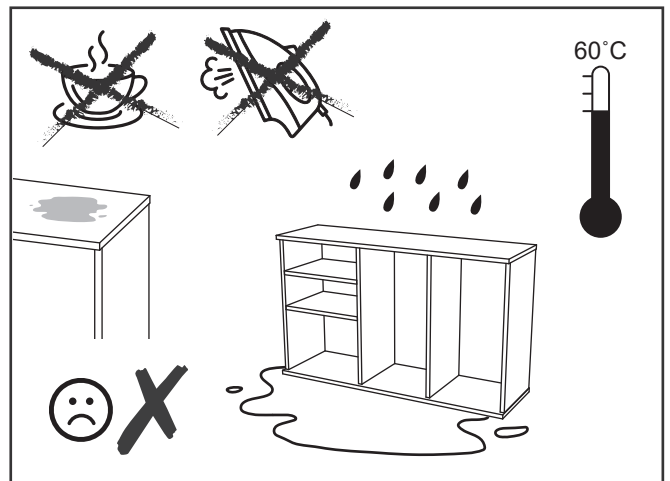
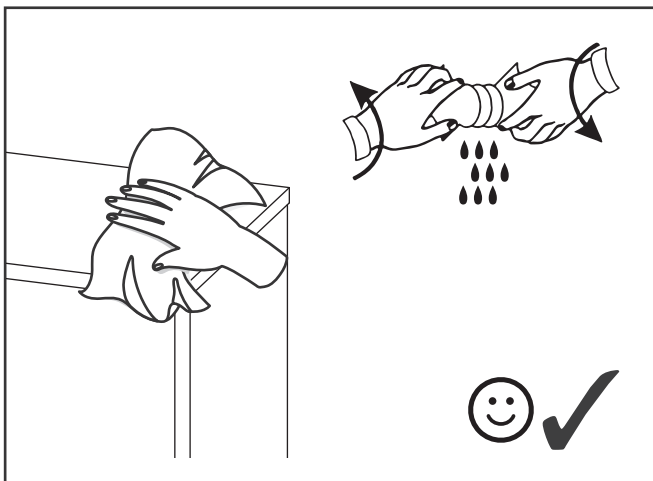
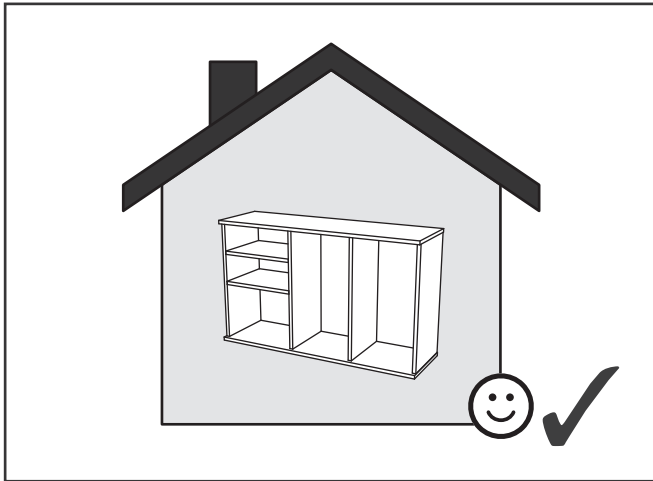

- PL** Powierzchnię mebli należy czyścić tylko środkami do pielęgnacji mebli. Szanowny kliencie w przypadku reklamacji prosimy wypełnić druki reklamacyjne dostępne w punktach sprzedaży przedkładając Kartę Reklamacyjną (zawierającą datę produkcji i numer pakowacza lub zmiany pakowania) umieszczona w każdej z paczek, oraz instrukcję montażu mebla, gdzie prosimy o zaznaczenie uszkodzonego elementu.
- SK** Povrch nábytku čistite iba prostriedkami určenými na ošetrovanie nábytku.Vá ení zákazníci! V prípade reklamácie prosíme, aby ste vyplnili tlačivá, ktoré sú prístupné v obchodoch, predlo ili Reklamačný list (ktorý obsahuje dátum výroby a číslo baliča alebo číslo zmeny pri balení), ktorý sa nachádza v ka dom balení a návod na montáž nábytku, v ktorom označte poškodenú čas.
- CZ** Povrch nábytku čistěte pouze přípravy určenými k ošetřování nábytku.Vá ený zákazníkú, v případě uplatnění reklamacie vyplňte prosím reklamační formuláře, které jsou dostupné v prodejnách a předlo te Reklamační kartu (obsahující datum výroby a číslo balení nebo změny balení, která je umístěna v balíčku) a návod k obsluze s vyznačením poškozeného dílu.
- BG** Повърхността на мебелите трябва да се почиства само с препарати за поддържане на мебели.Уважаеми клиенти, в случай на рекламация моля попълнете формулярите за рекламация, които ще получите в търговските пунктове, като представите Картата за рекламация (съдържаща датата на производство и номера на опаковчика или смяната за опаковане), която ще намерите във всяка опаковка, и инструкцията за монтаж на мебела, върху която да отбележите повредения елемент.
- RO** Suprafata ei trebuie să fie curătată numai cu substanțe destinate pentru curățarea mobilei.Stimate Cumpărător, în caz de reclamatie vă rugăm să completați formularul de reclamatie pe care îl puteți lua de la punctul de vânzare și pe care îl veți prezenta împreună cu Cartela de Garantie (care conține data producției și nr ambalatorului sau turei de ambalare), însoțită la fiecare ambalaj, precum și instrucțiunile de montaj ale mobilei, pe care vă rugăm să marcați elementul deteriorat.
- UA** Поверхню меблів потрібно чистити тільки засобами для догляду за меблями.Шановний клієнте для заяви рекламачії, просимо заповнити формуляр рекламачії, доступний у пунктах продажу, вказуючи рекламачійну карту (містить дату виробництва та номер пакувальника або зміни упаковки), прикладену до кожного пакету, а також інструкцію з монтажу меблів, на якій просимо позначити пошкоджений елемент.
- RUS** Поверхность мебели надо чистить только средствами для ухода за мебелью.Уважаемый клиент для заявления рекламации, просим заполнить формуляр рекламации, доступный в пунктах продажи, указывая Рекламационную карту (содержащую дату производства и номер упаковщика или смены упаковки), приложенную к каждому пакету, а также инструкцию по монтажу мебели, на которой просим обозначить поврежденный элемент.
- DE** Reinigen Sie den Möbelbereich nur mit Möbelpflege. Kunden, bei Beanstandung Bitte füllen Sie die Reklamationsformulare, die in den Verkaufsabteilungen erhältlich sind, vor dem Verkauf aus eine Reklamationskarte (mit Angabe des Produktionsdatums und der Anzahl der Personen, die die Waren verpacken, oder der Anzahl der Schichten)Verpackung), die in jeder Packung enthlten ist, und Halterungen, in denen Sie reichlich vorhanden oder beschädigt sind ElementeReinigen Sie den Möbelbereich nur mit Möbelpflege. Kunden, bei Beanstandung.
- GB** Furniture surface must be cleaned only with furniture maintenance formulas.Dear Customer, should you wish to file a complaint, we would request you to fill in the complaint forms available in our outlets, submitting the Complaint Card (specifying the date manufactured, packaging employee/ shift code) enclosed in each of the packets, together with the Assembly Manual, where please highlight the faulty component.
- H** A bútorok felületét kizárólag a bútorápolószerekkel lehet tisztítani. Tisztelt Vásárló! Reklamáció esetén kérjük az eladási helyeken kapható reklamációs nyomtatványokat kitölteni a Reklamációs Lap (tartalmazza a gyártási dátumát és csomagoló számát vagy műszakszámát) bemutatásával, amely mindegyik csomagban található, valamint a bútor szerelési utasítását, amelyen kérjük a sérült elemet bejelölni sziveskedjék.
- FR** La surface des meubles ne peut être nettoyée qu'avec des produits pour l'entretien de meubles. Cher Client, en cas de réclamation, veuillez bien remplir des formulaires de réclamation accessibles dans les centres de vente en montrant le mode d'emploi pour monter le meuble. Nous vous demandons de bien vouloir y entourer l'élément en panne.
- ES** Limpiar la superficie de muebles exclusivamente con los agentes para el cuidado de los muebles.Estimado Cliente, en caso de reclamaciones, hagan favor de rellenar los formularios de reclamación disponibles en los puntos de venta, presentando las instrucciones de montaje de mueble, donde es necesario indicar un elemento estropeado.
- NL** Het oppervlak van meubels hoeft alleen te worden gereinigd door middel van meubelverzorging Beste klant voor de verklaring!
klacht, vul dan het klachtenformulier in dat beschikbaar is in de verkooppunten, met vermelding van: klachtenkaart (bevat de fabricagedatum en het nummer van de verpakker of verandering van verpakking), bevestigd aan elk pakket, evenals instructies voor het installeren van meubels, die we u vragen te markeren beschadigd item.