

R4 300x600x320

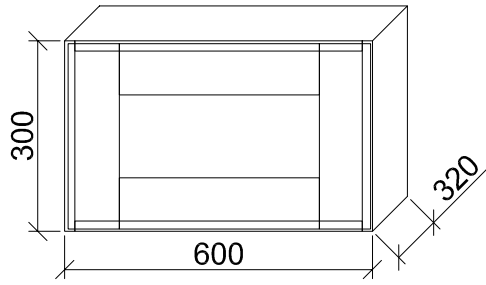

R4

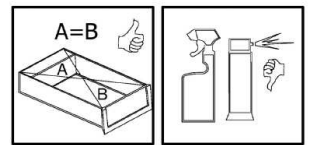
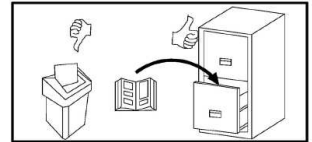
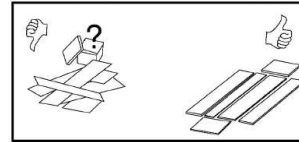
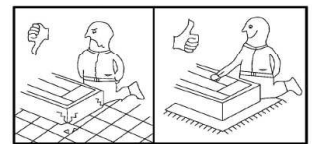
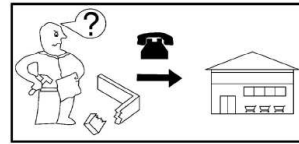
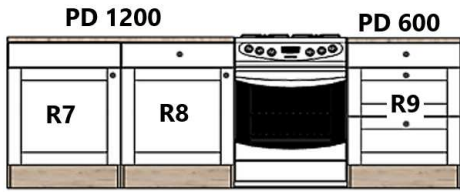
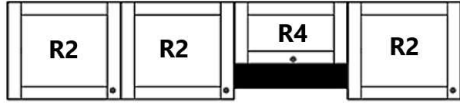
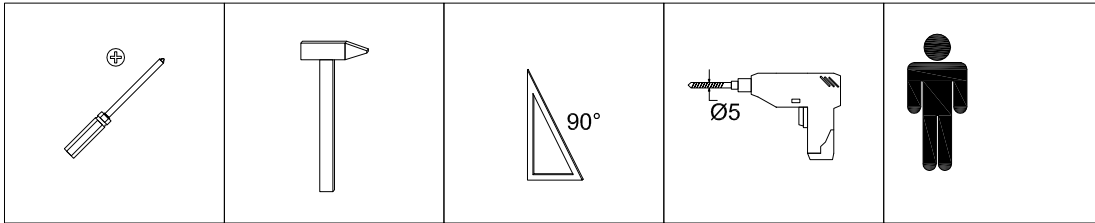
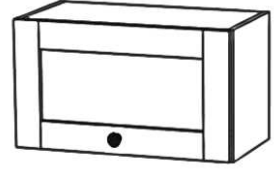
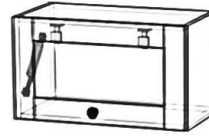

A	x8	C2	x12	F	x20	G	x2	J1	x1	M	x2	L	x2
		3,5x16mm											
8x40										Ø35mm			

N	x1	O3	x8	O9	x1	O11	x8
		Ø13mm					
				4mm		7x50	

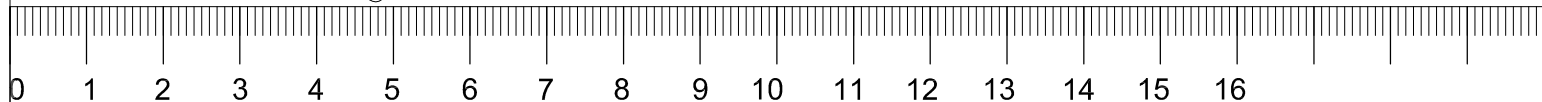
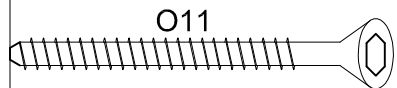

R4 300x600x320

R4

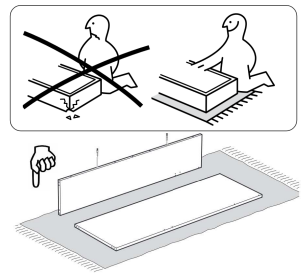
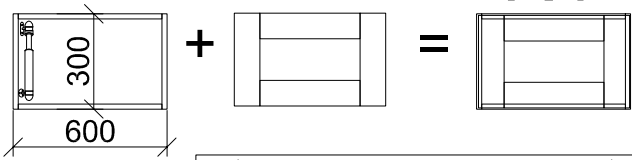

I

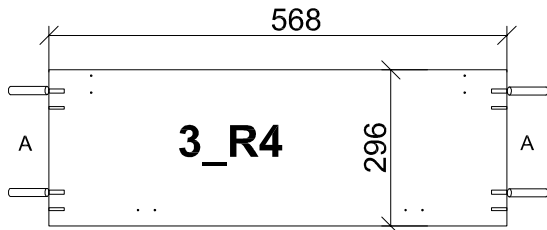

O11

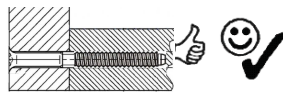

II

O9

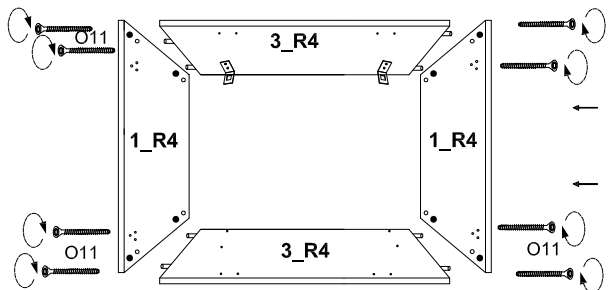

5_R2 (v=298)

298

cca 90 mm

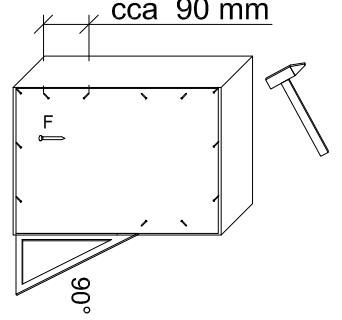

J11

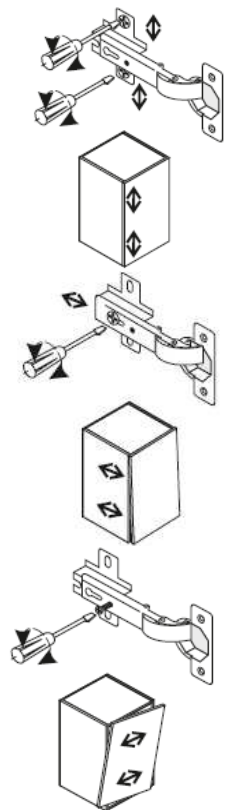
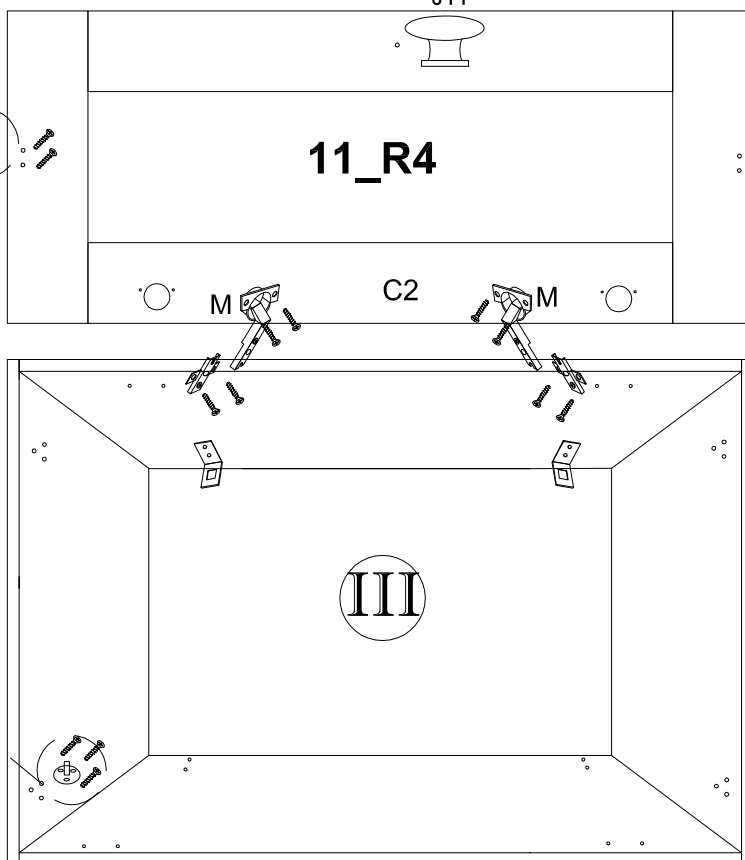

G x1

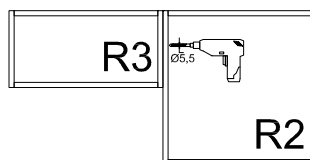

⊗

2/2