

LEWY/LINKS

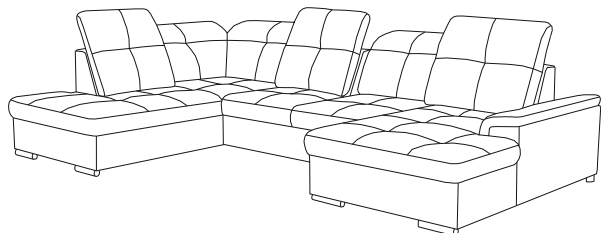

PRAWY/RECHTS

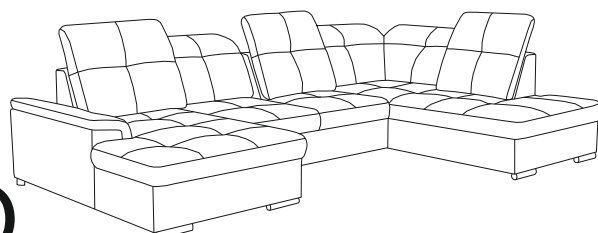

BRUNO

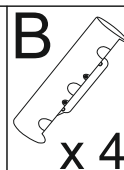
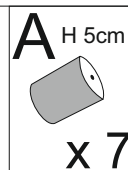
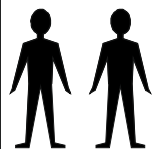

LEWY/LINKS

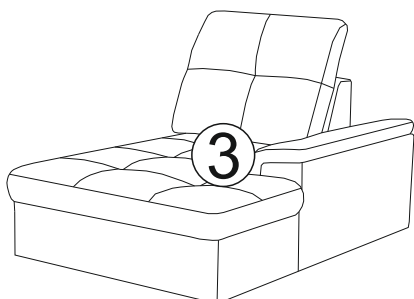
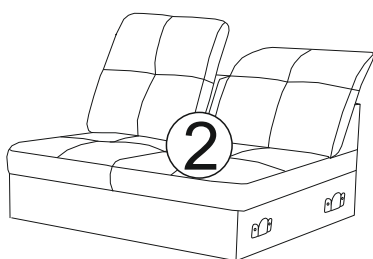
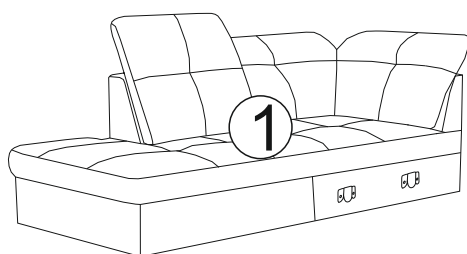

PRAWY/RECHTS

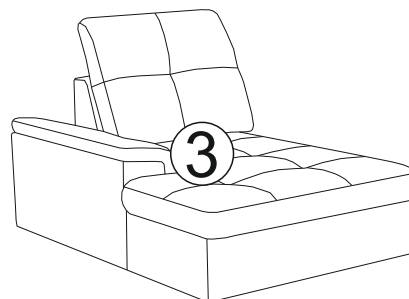
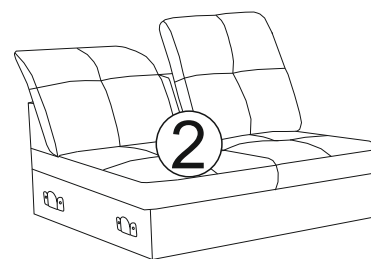
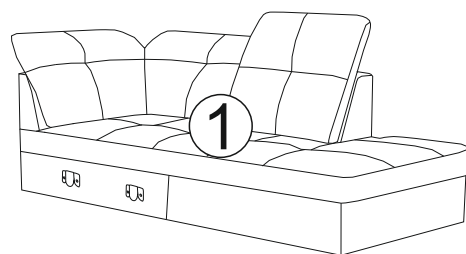

Przygotowanie mebli do użytku po rozpakowaniu. Möbelvorbereitung für den gebrauch nach dem auspacken.

Po rozpakowaniu należy ręcznie ułożyć poduszki.

To przyspieszy proces prawidłowego uformowania się i powrotu do pierwotnego kształtu.

Meble są transportowane samochodem, czasem pokonują duże odległości z fabryki do Państwa, dlatego wskazane będzie ręczne uformowanie mebla.

To samo robimy z całym pokrowcem.

Nach dem Auspacken empfehlen wir eine zusätzliche manuelle Kissenbildung. Dies beschleunigt den Prozess der korrekten Formgebung und stellt das ursprüngliche Erscheinungsbild wieder her. Möbel werden mit dem Auto transportiert, manchmal müssen sie eine sehr lange Strecke von der Fabrik zu Ihnen nach Hause zurücklegen. Es genügt, mit den Händen die ursprüngliche Form wiederherzustellen. Dasselbe machen wir mit dem gesamten Möbelbezug.

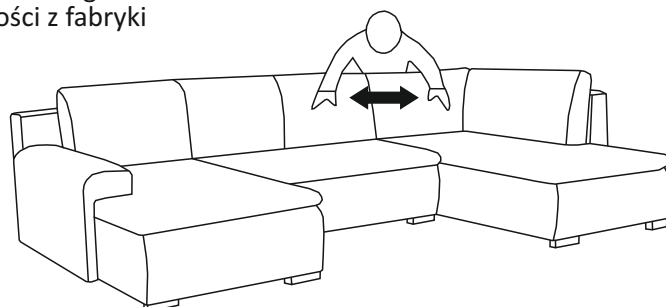

LEWY/LINKS

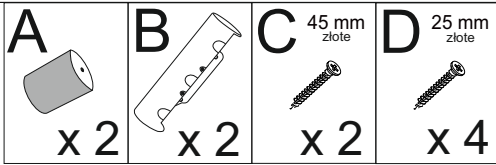

PRAWY/RECHTS

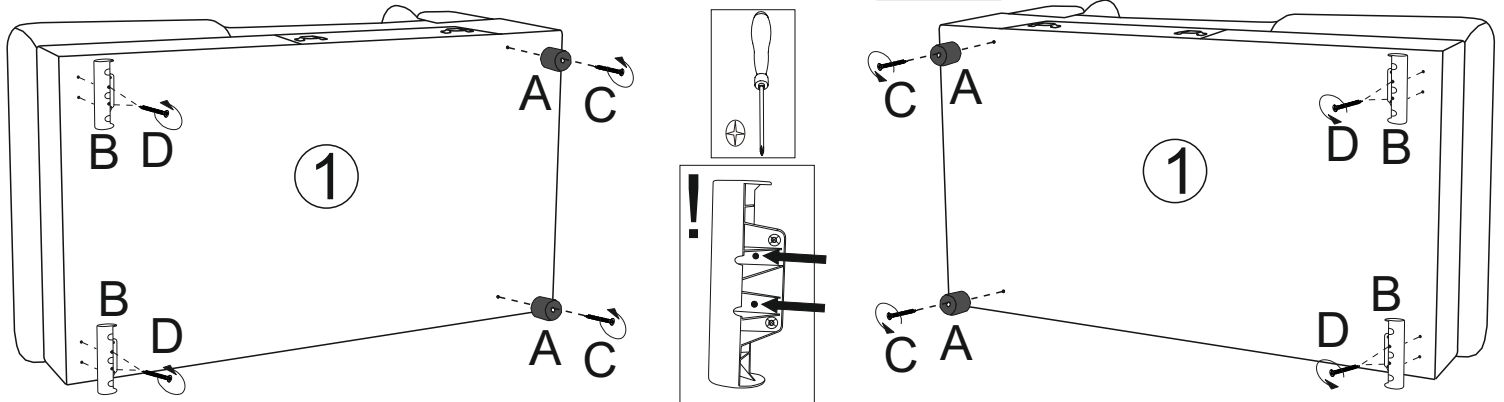

LEWY/LINKS
PRAWY/RECHTS

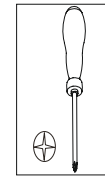
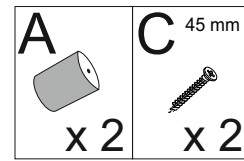
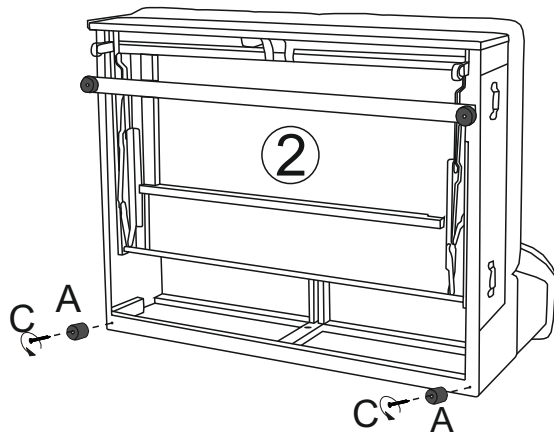

LEWY/LINKS

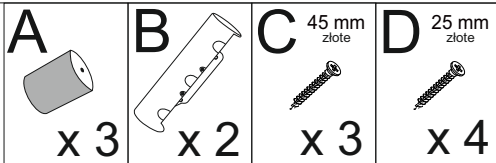

PRAWY/RECHTS

