

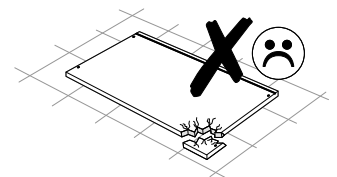

Modell **PACO 5**

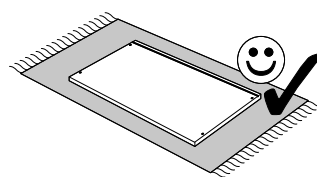

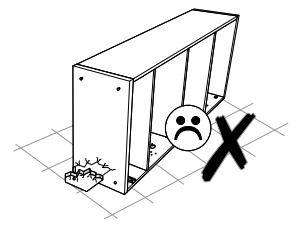
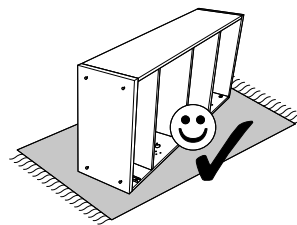
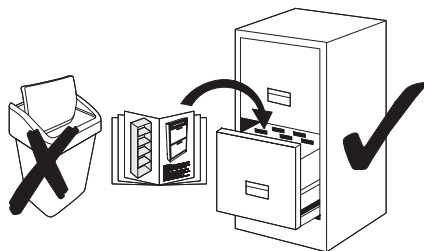
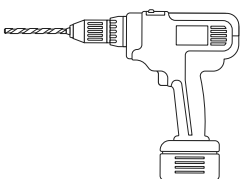
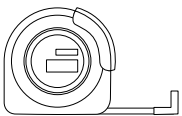
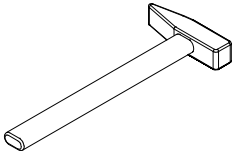
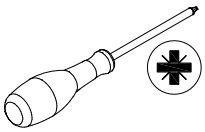
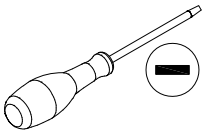
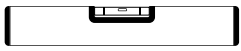
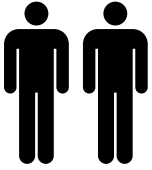
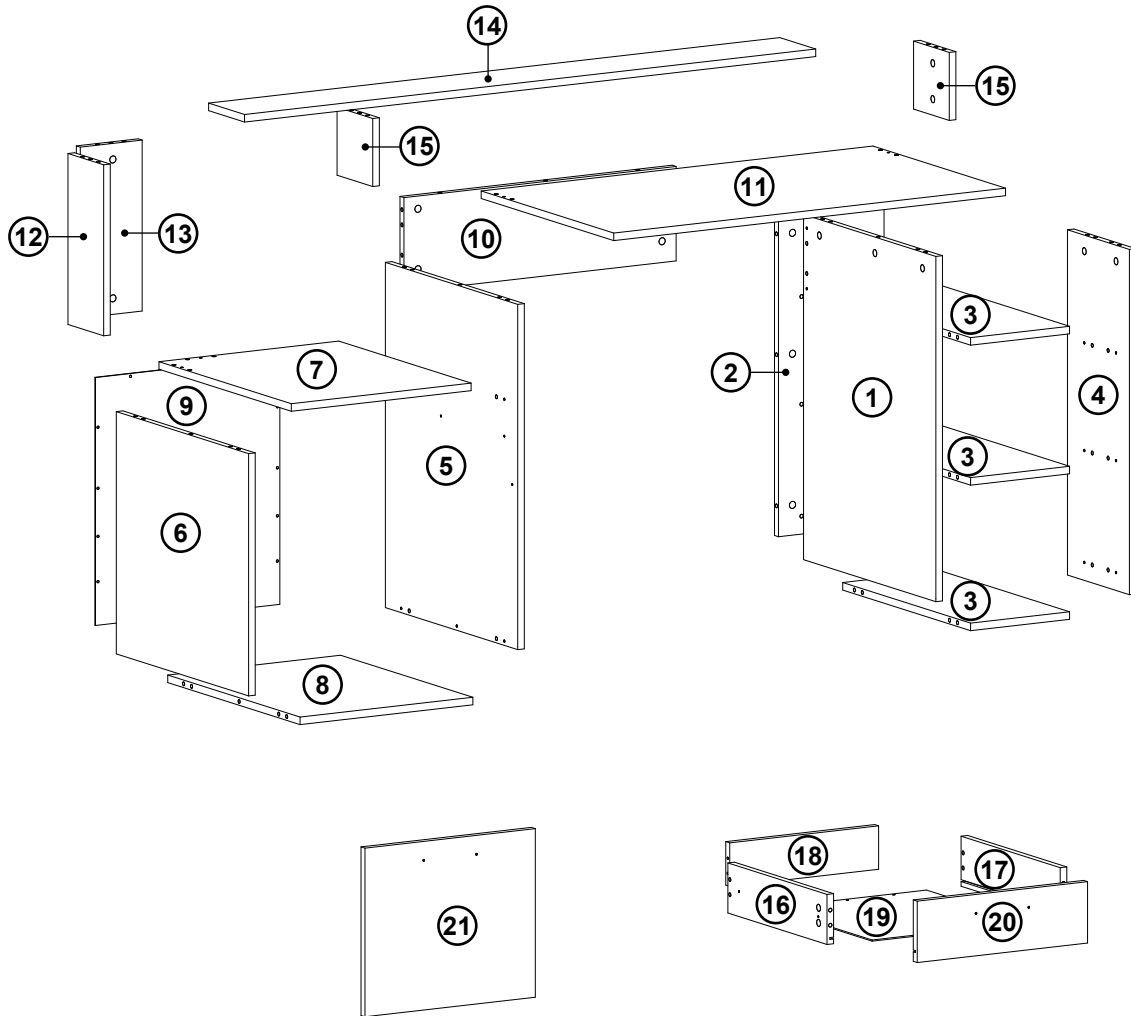
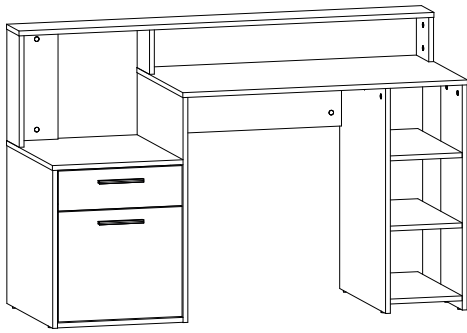

A	B (mm)			C	D
1	731	534	16	x1	1/2
2	731	256	16	x1	1/2
3	240	516	16	x3	1/2
4	731	250	16	x1	1/2
5	731	534	16	x1	1/2
6	513	534	16	x1	1/2
7	436	534	16	x1	1/2
8	419	534	16	x1	1/2
9	525	447	2,5	x1	1/2
10	660	200	16	x1	1/2

A	B (mm)			C	D
11	950	535	16	x1	1/2
12	362	144	16	x1	1/2
13	362	150	16	x1	1/2
14	1285	145	16	x1	1/2
15	144	144	16	x2	1/2
16	400	106	16	x1	1/2
17	400	106	16	x1	1/2
18	361	92	16	x1	1/2
19	377	408	2,5	x1	1/2
20	413	130	16	x1	1/2
21	413	357	16	x1	1/2

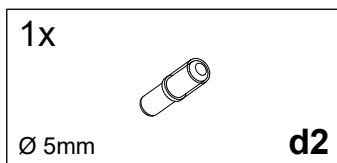
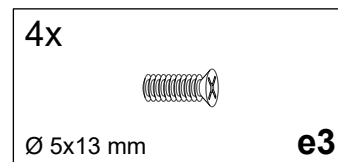
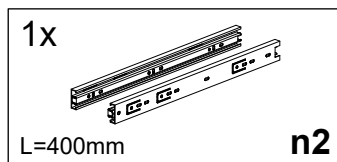
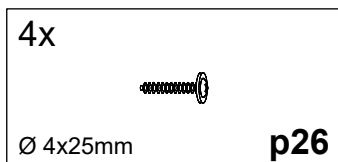
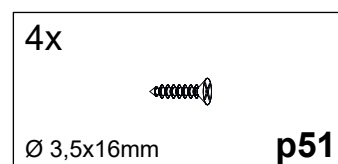
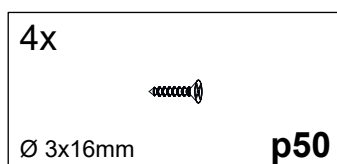
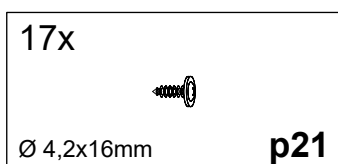
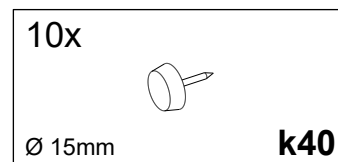
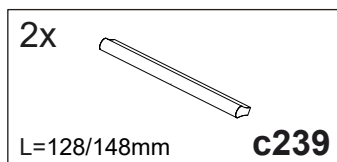
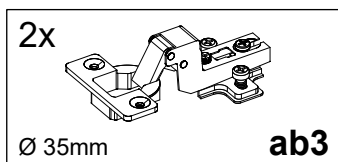
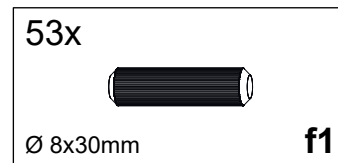
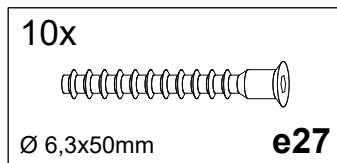
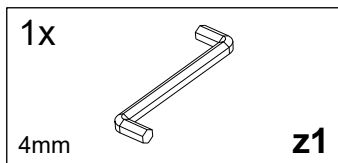
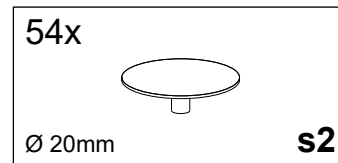
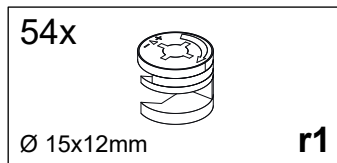
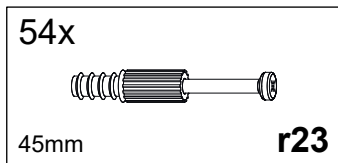
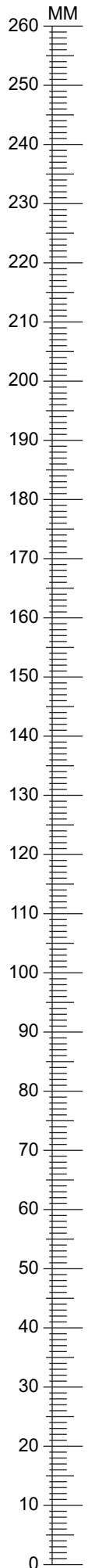

1

f1 x 27



Ø 8x30mm

r1 x 28



Ø 15x12mm

r23 x 4



45mm

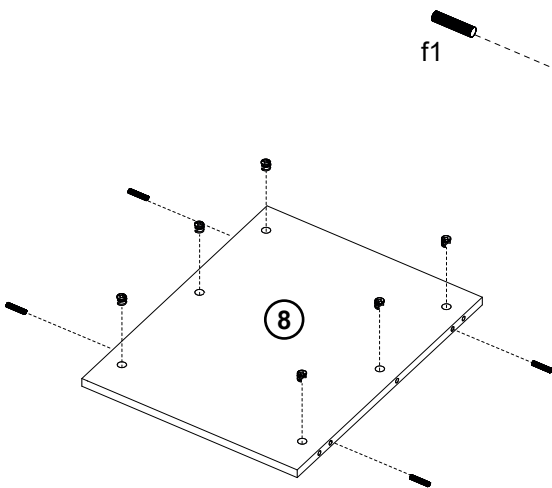
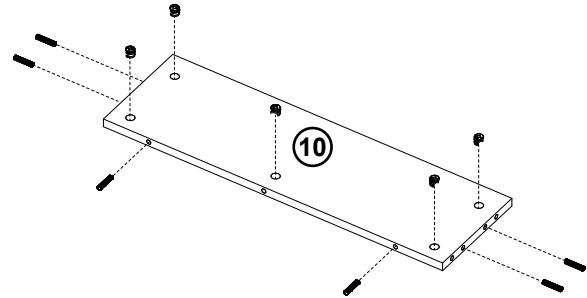
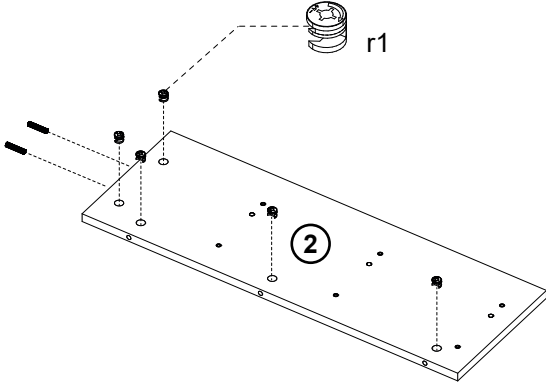
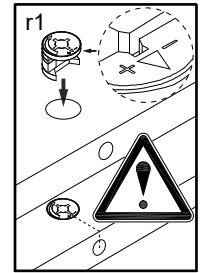
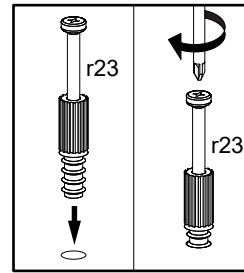

f1

3 x 3

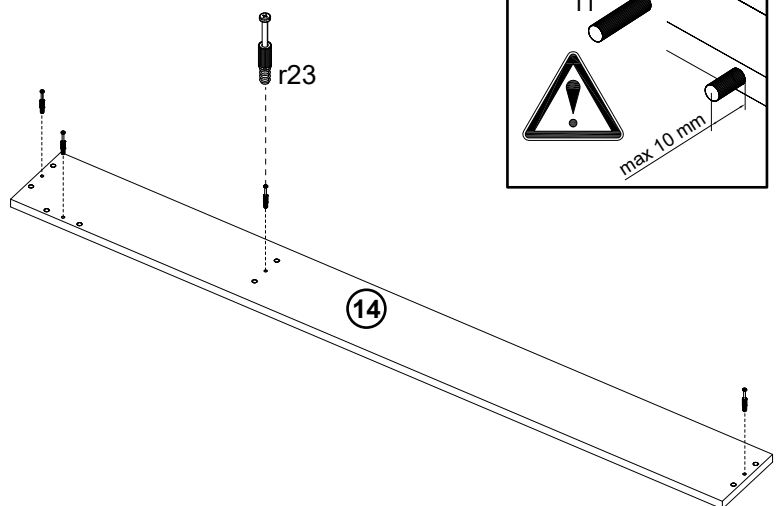

r23

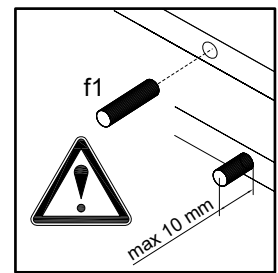

max 10 mm

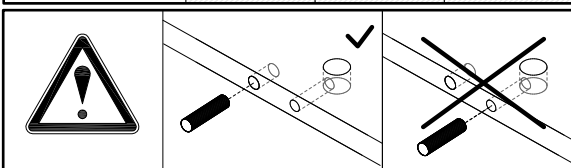
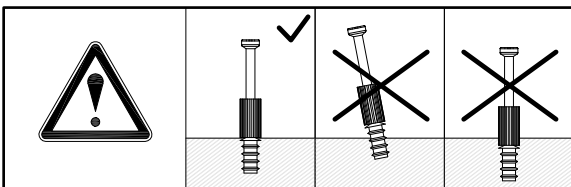

2

f1 x 20



Ø 8x30mm

r1 x 13



Ø 15x12mm

r23 x 9



45mm

e3 x 2



Ø 5x13mm

n2 x 1

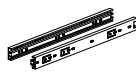

L=400mm

b3 x 2



40x50x12mm

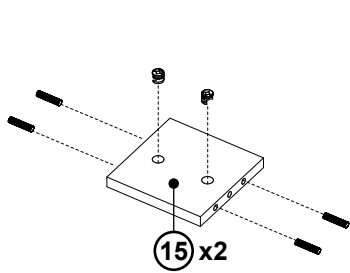

15 x 2

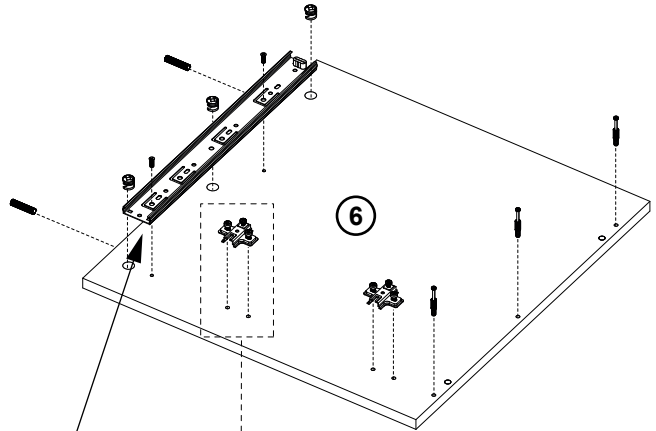

6

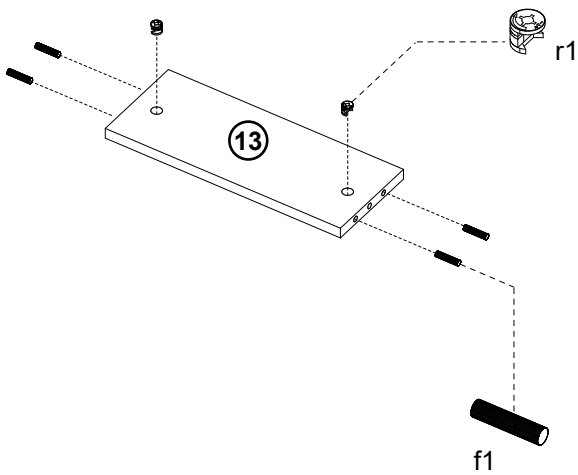
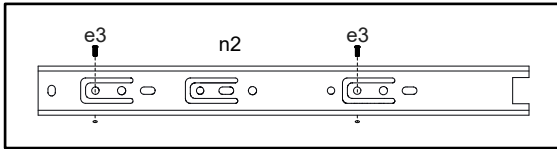

13

r1

f1

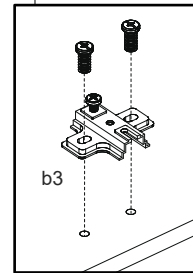

b3

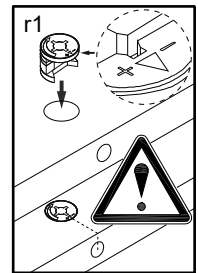

r1

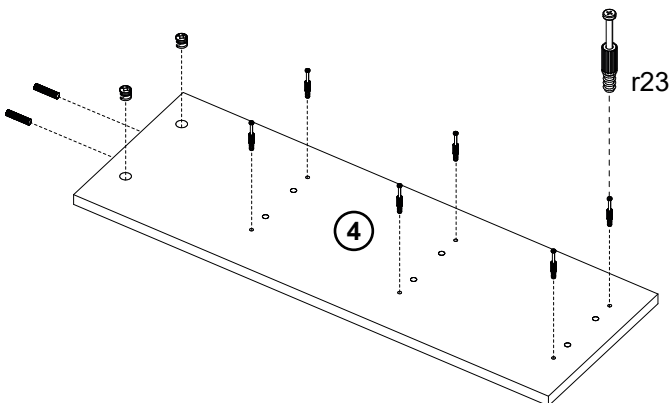

4

r23

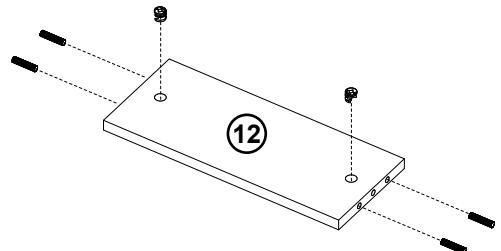

12

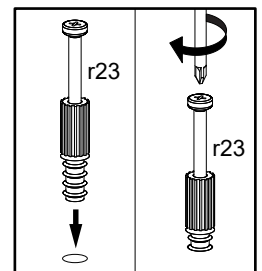

r23

r23

3

f1 x 6
Ø 8x30mm

r1 x 9
Ø 15x12mm

r23 x 37
45mm

e3 x 2
Ø 5x13mm

n2 x 1
L=400mm

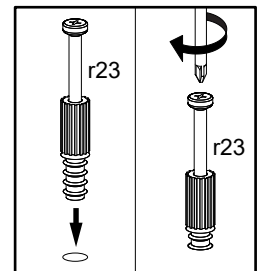
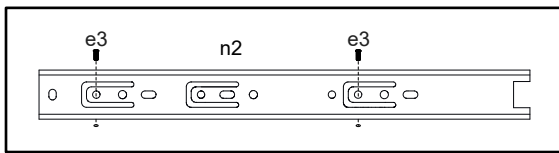
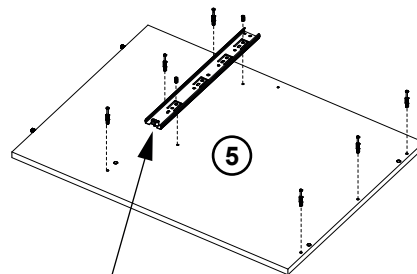
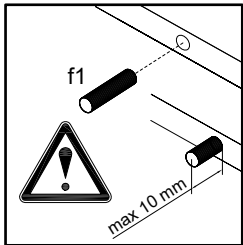
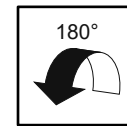
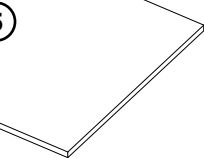
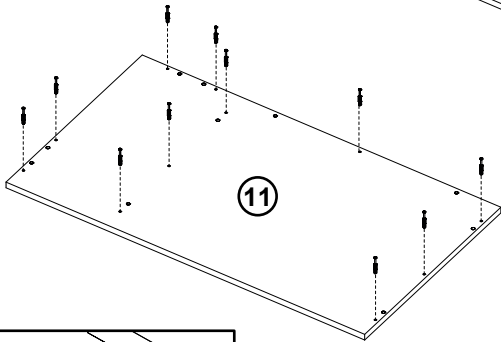
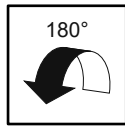
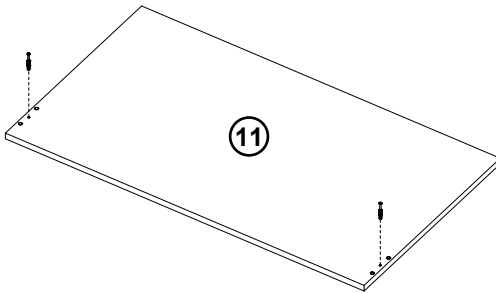
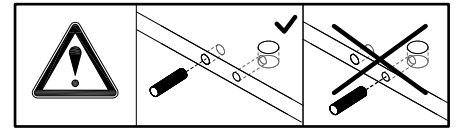
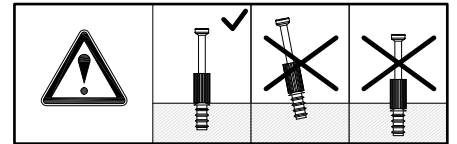
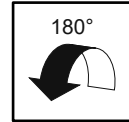
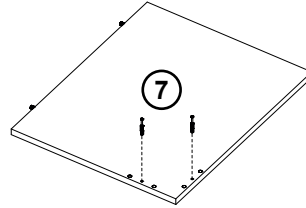
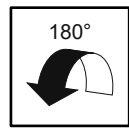
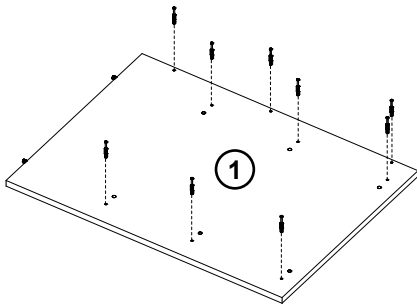
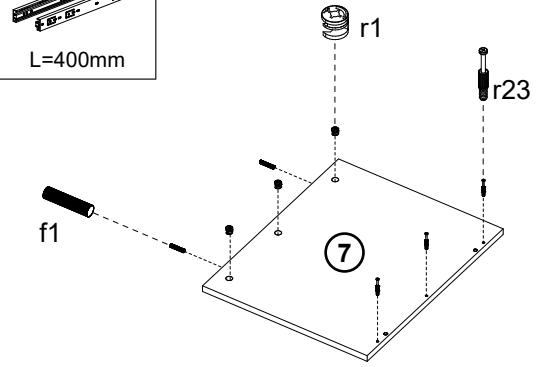
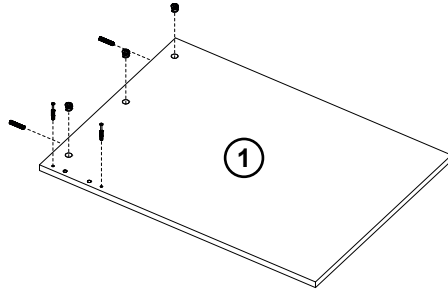
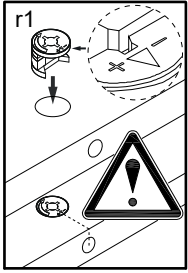

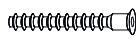
4	z1 x 1	e27 x 6
	 4mm	 Ø 6,3x50mm

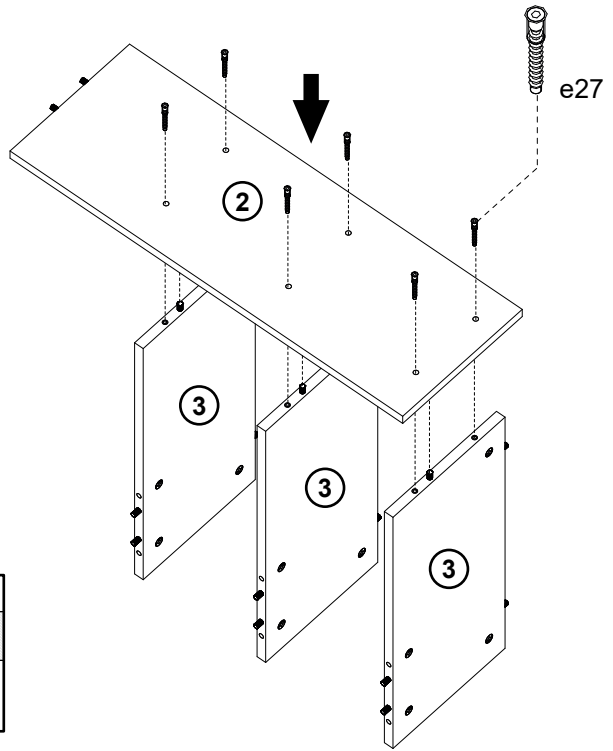
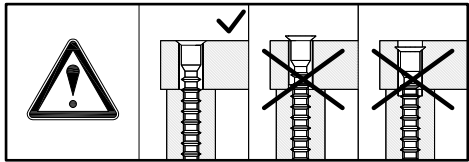
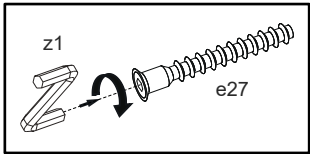

5	s2 x 15
	 Ø 20mm

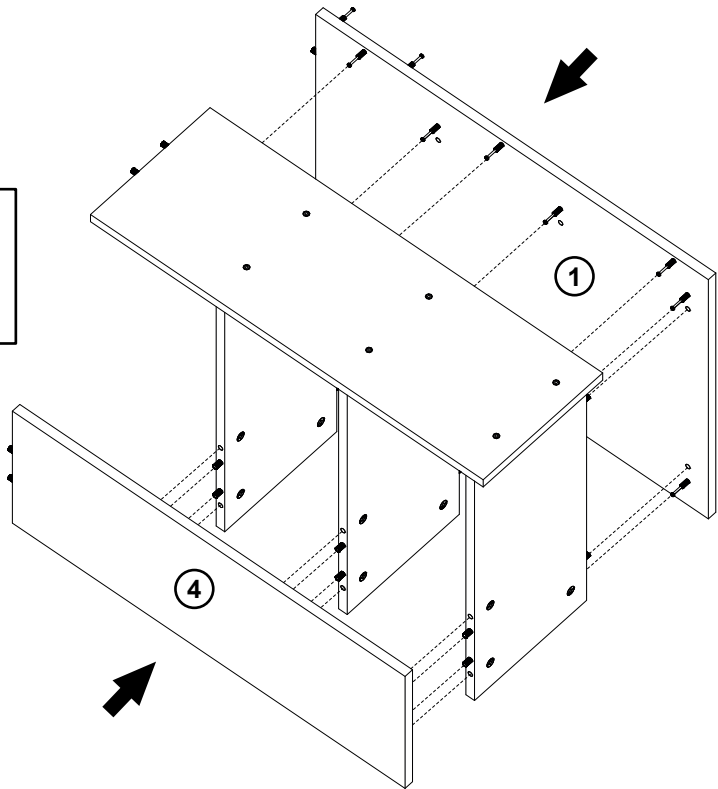
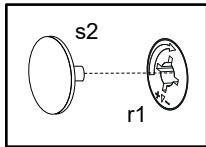
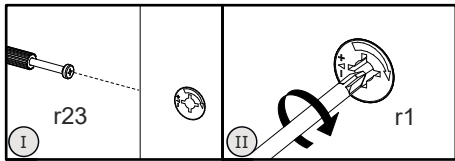

6

k40 x 6



Ø 15mm

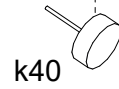
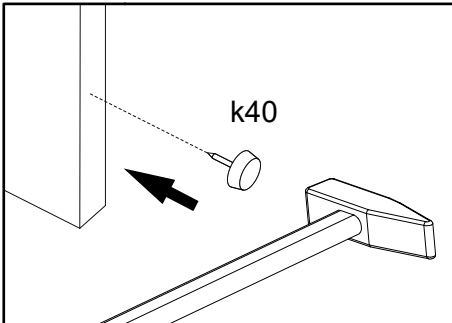
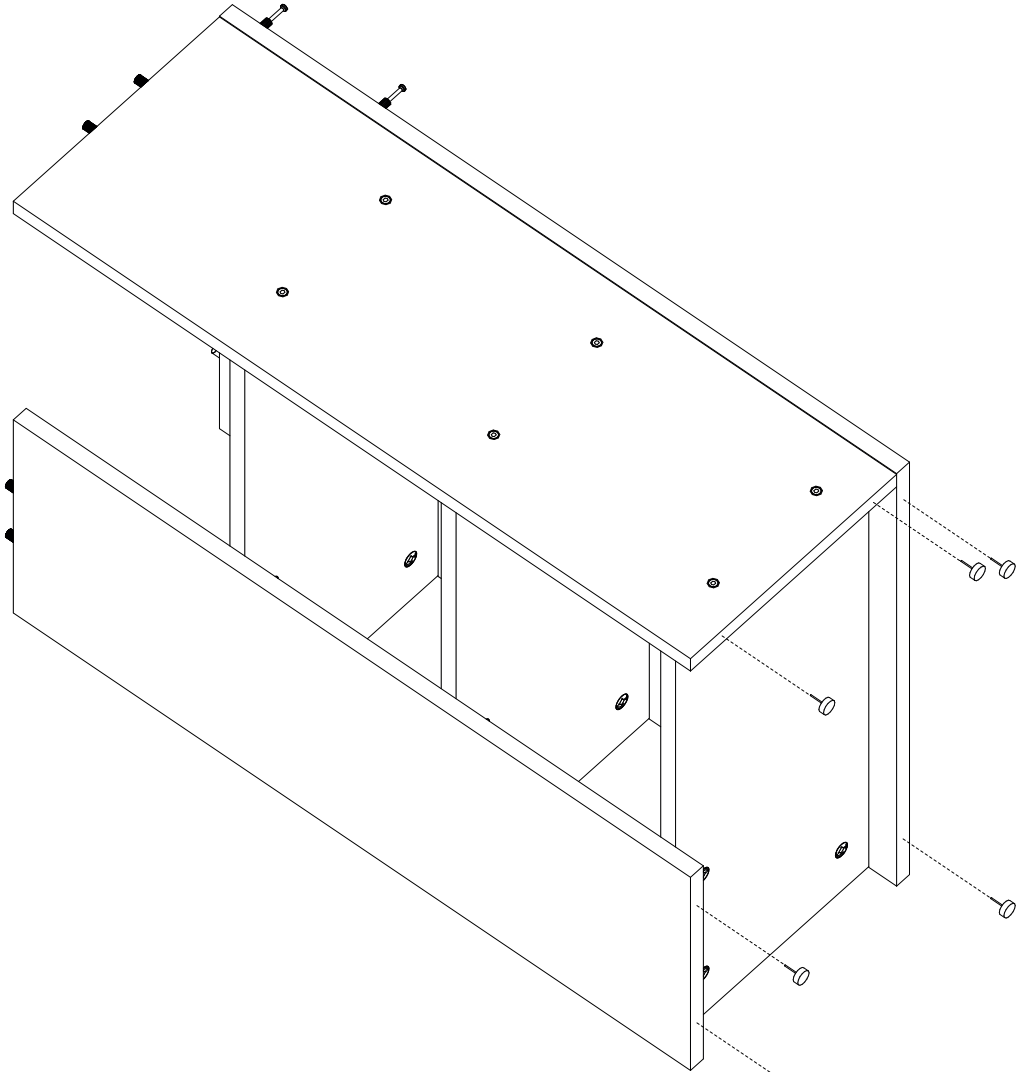

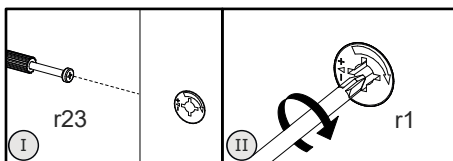
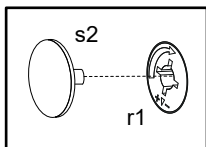
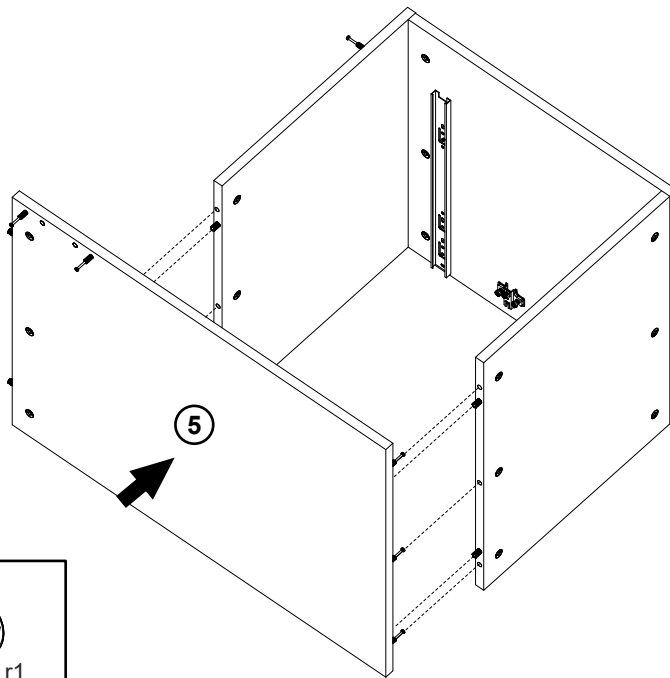
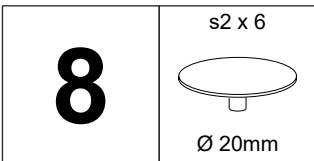
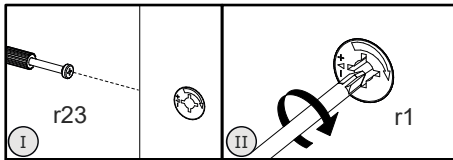
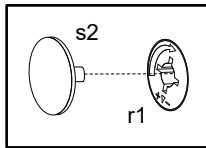
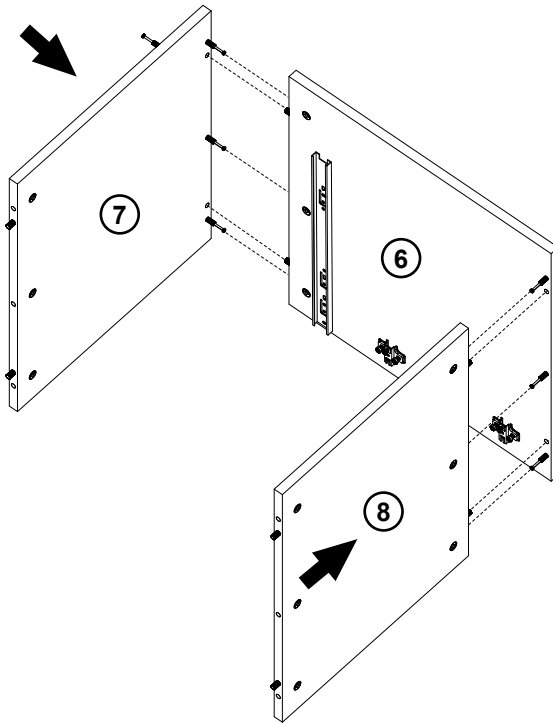
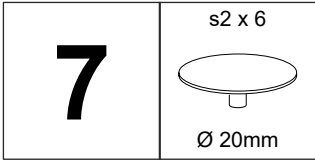

9

p21 x 14



Ø 4,2x16mm

k40 x 4



Ø 15mm

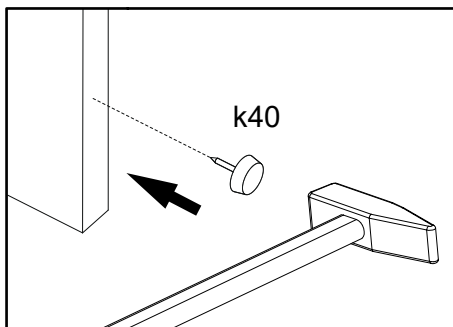
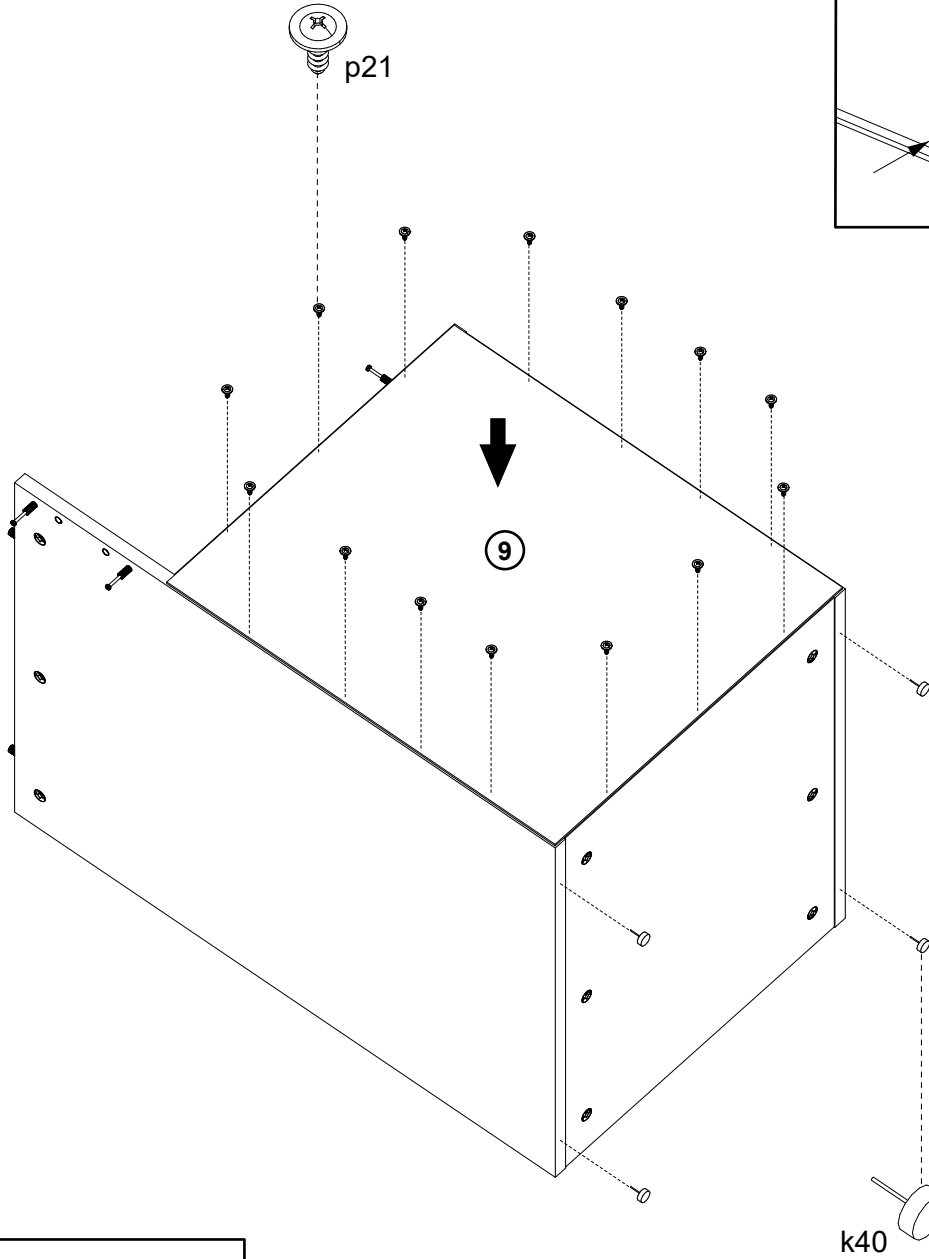
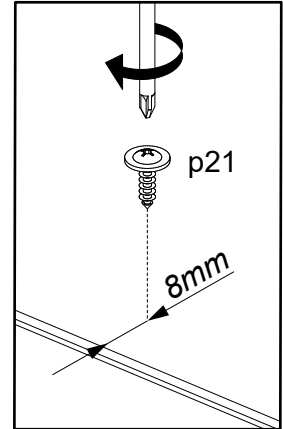

10

s2 x 4



Ø 20mm

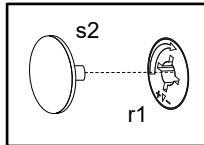
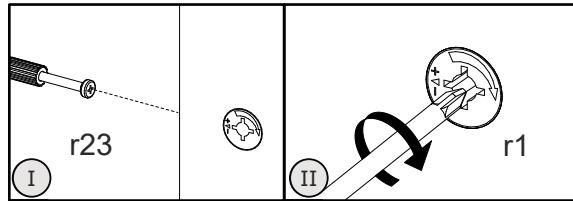
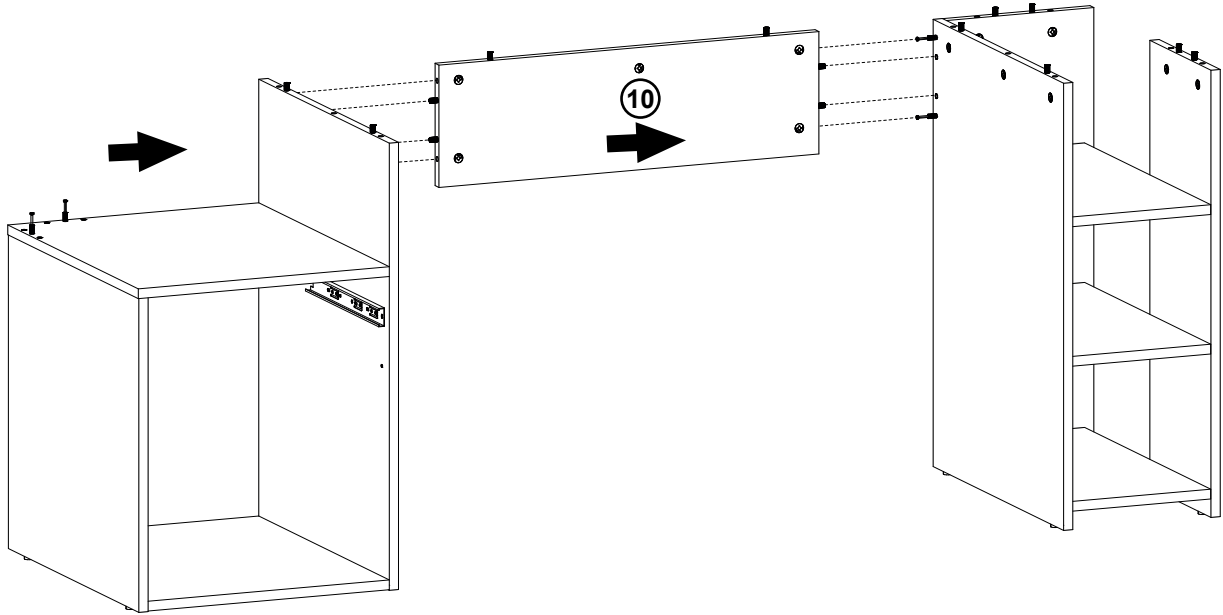

11

s2 x 11



Ø 20mm

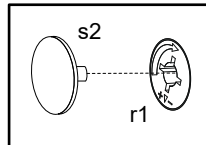
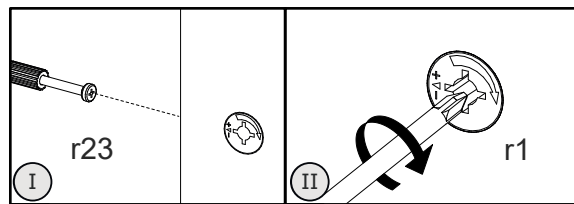
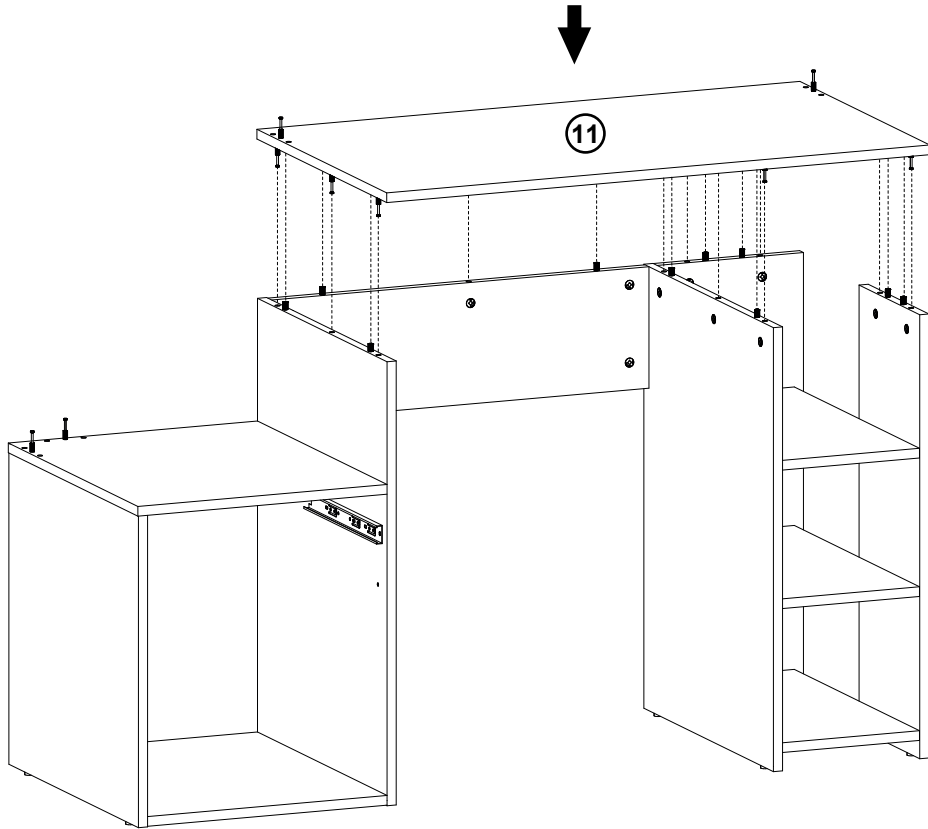

12

s2 x 8

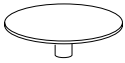

Ø 20mm

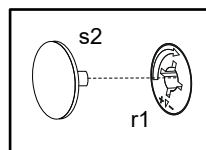
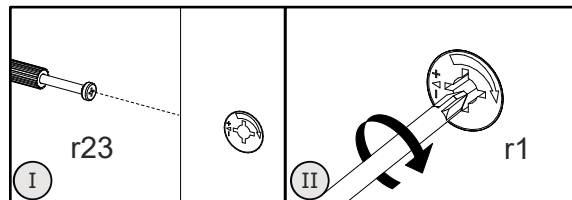
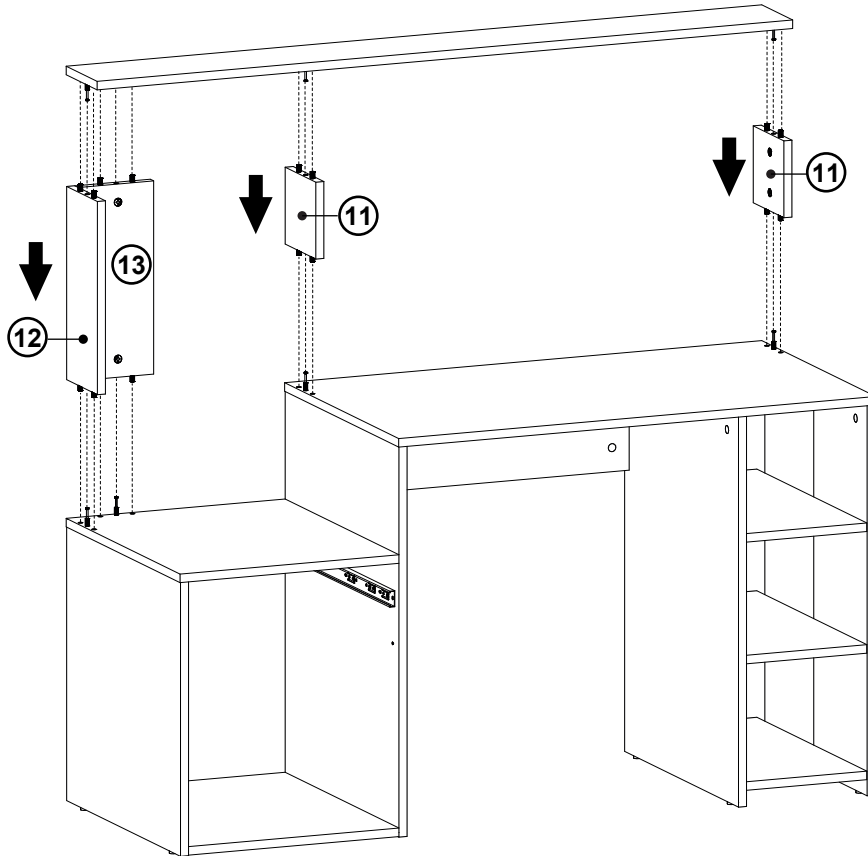

13

p26 x 2



Ø 4x25mm

c239 x 1



L=128/148mm

r1 x 4



Ø 15x12mm

r23 x 4



45mm

z1 x 1



4mm

e27 x 4

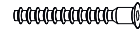

Ø 6,3x50mm

s2 x 4

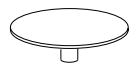

Ø 20mm

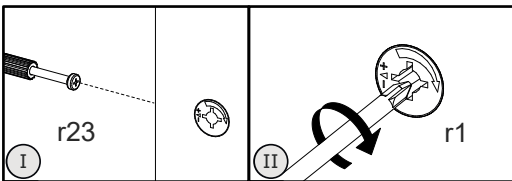
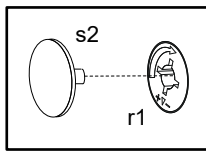
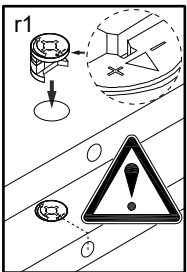
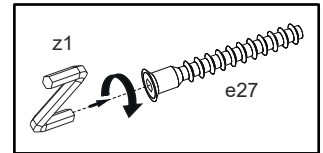
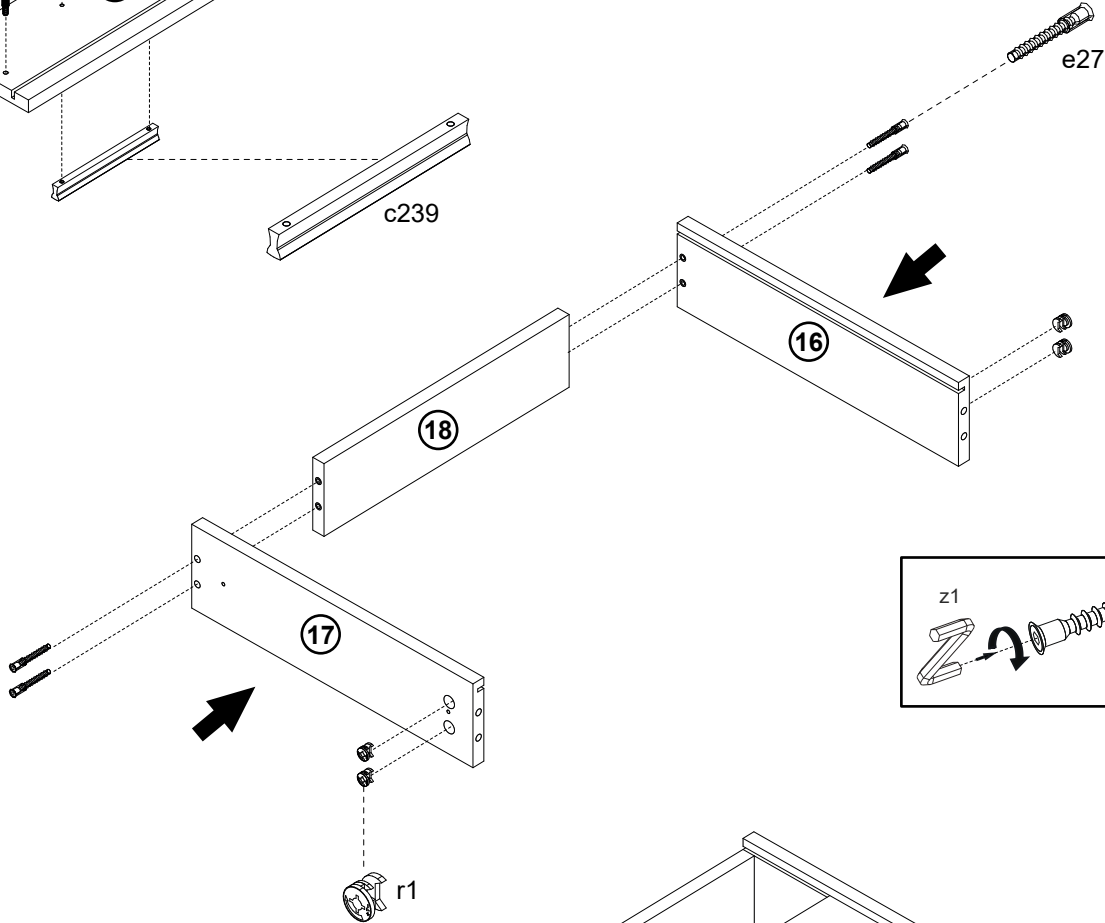
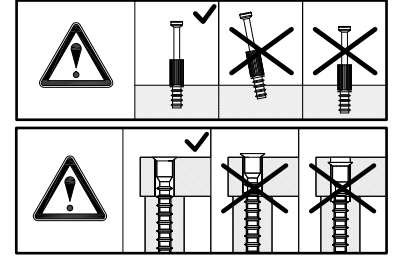
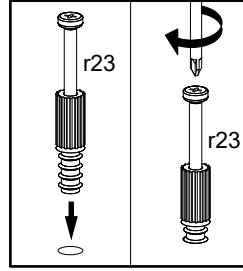
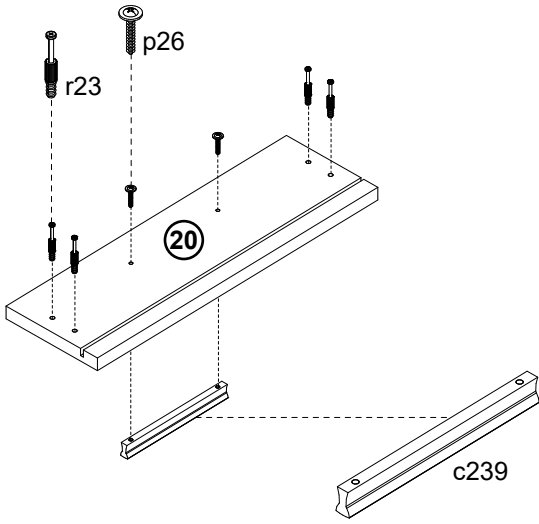

14

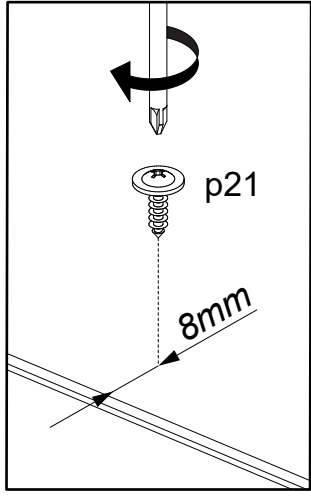
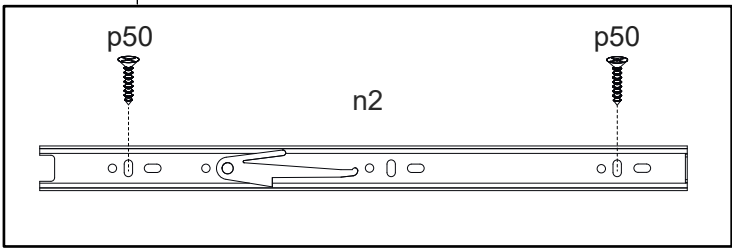
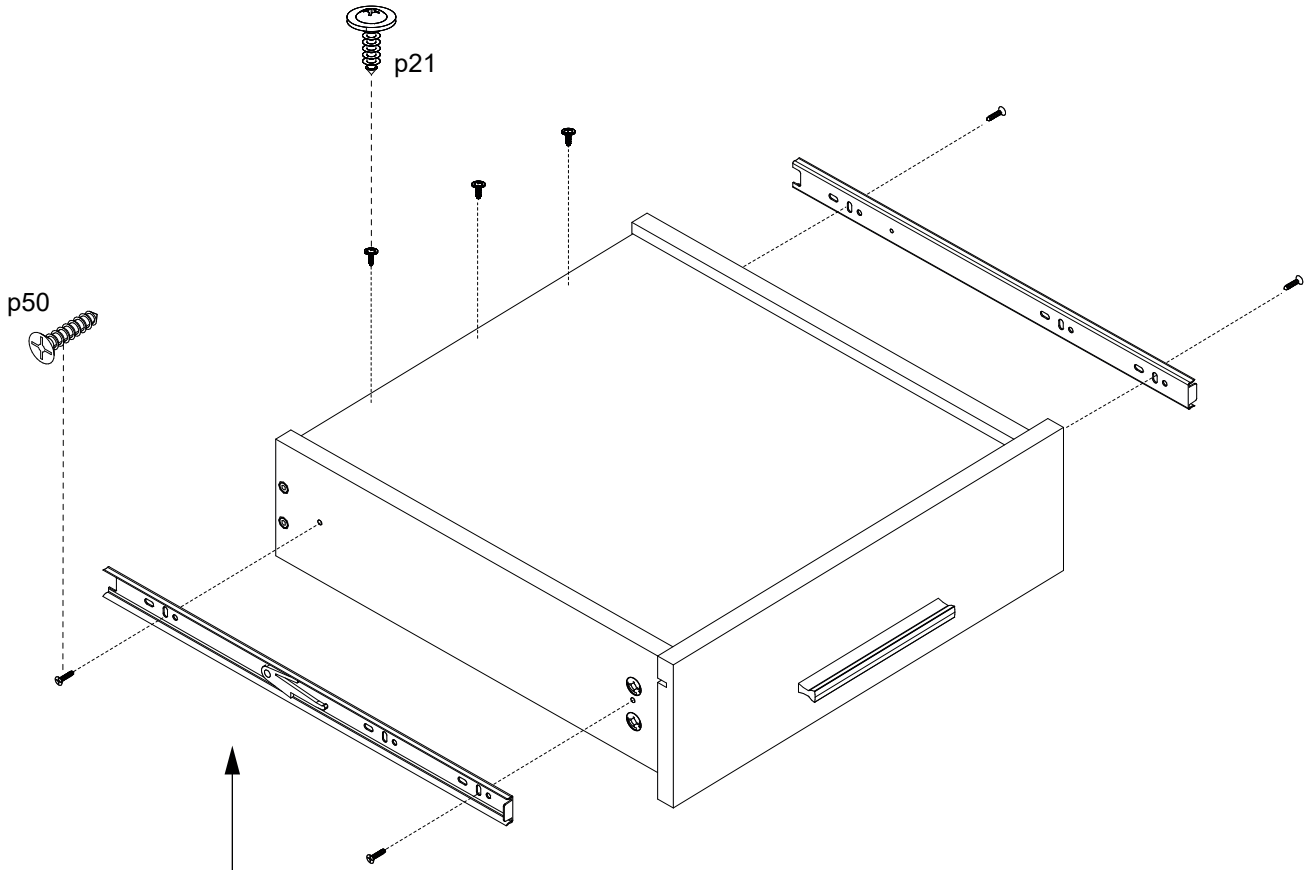
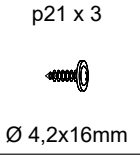
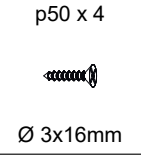
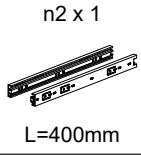

15

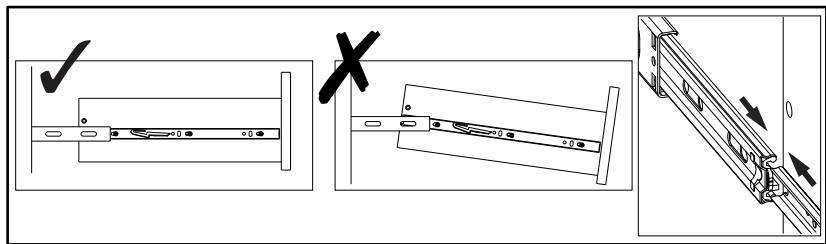
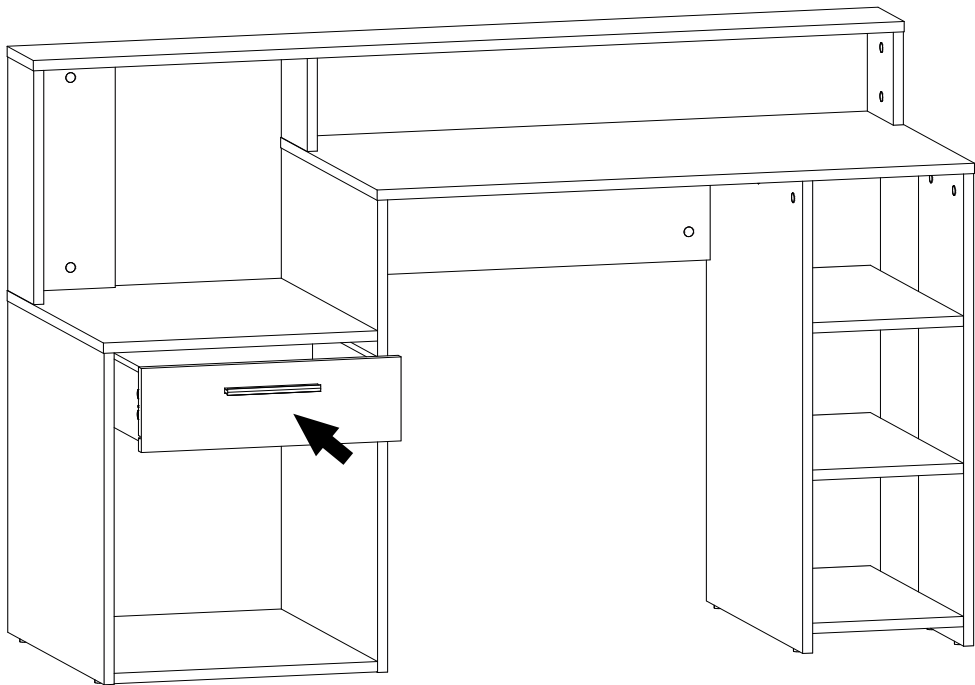
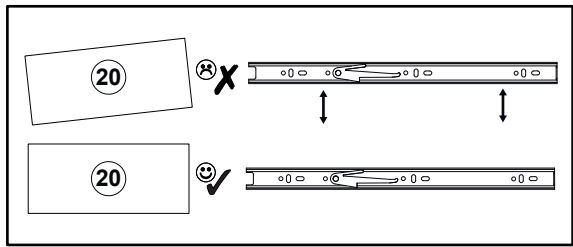

16

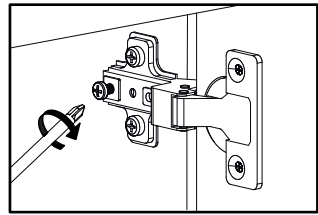
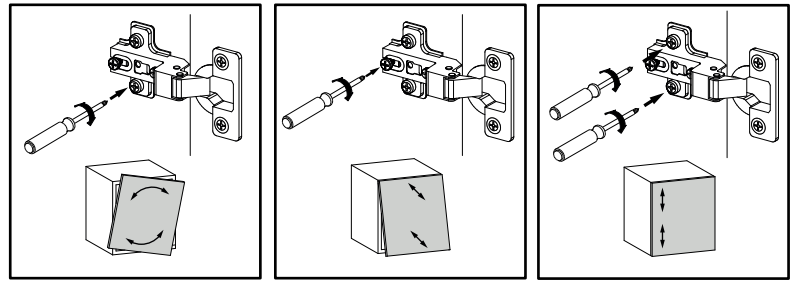
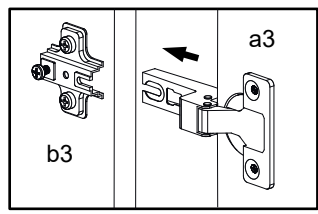
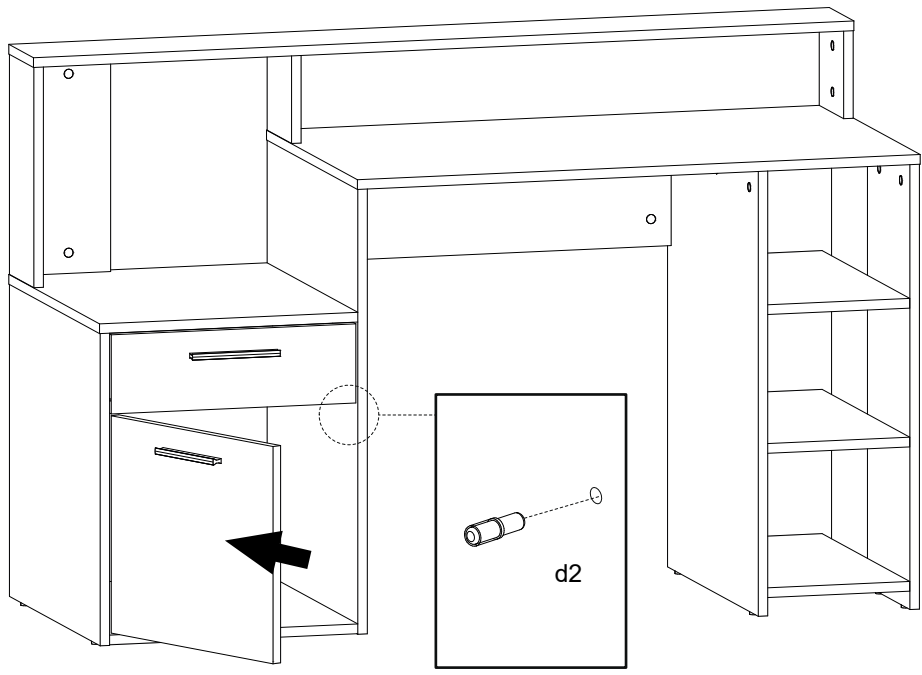
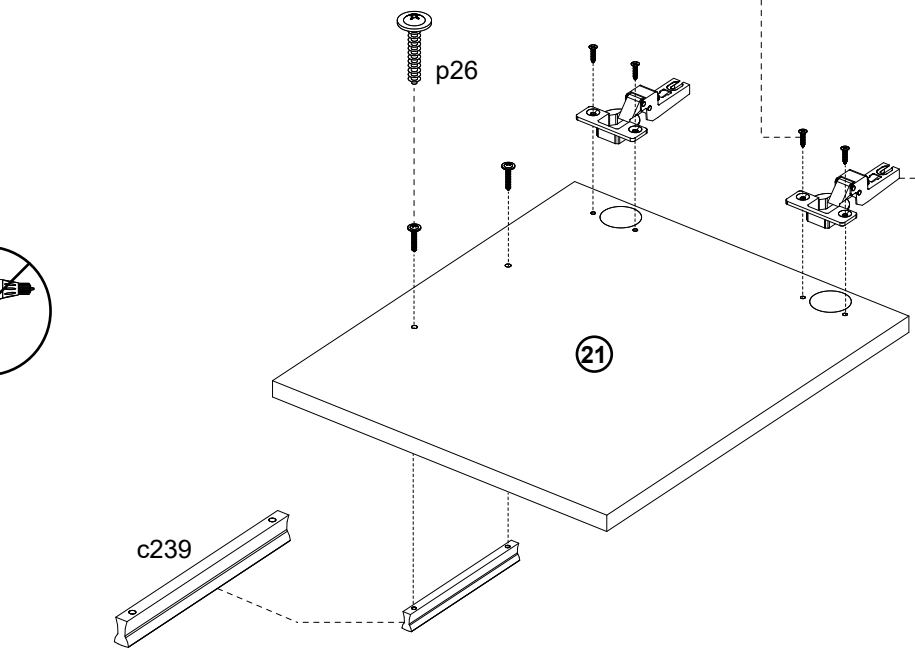
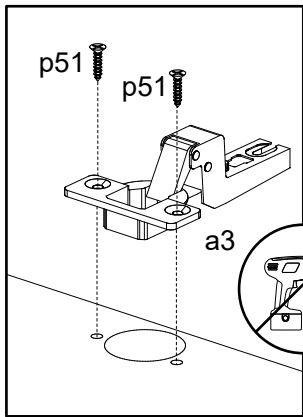
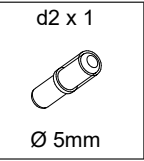
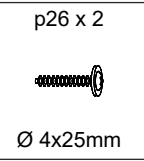
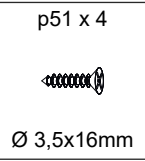
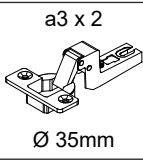

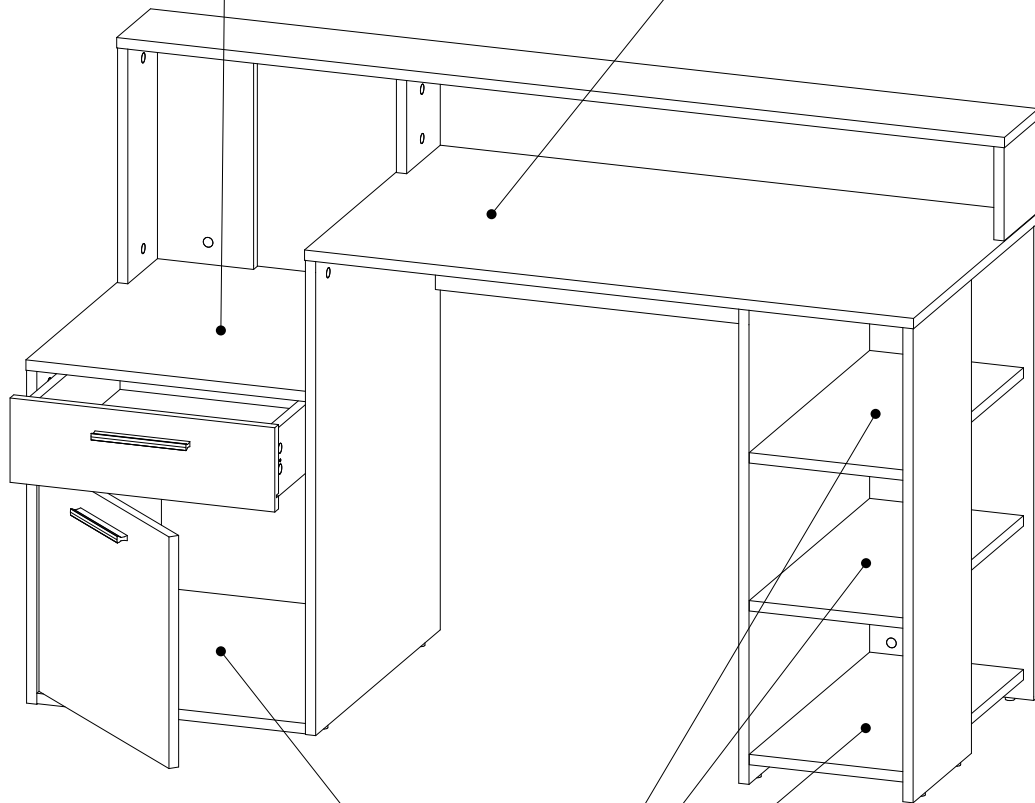

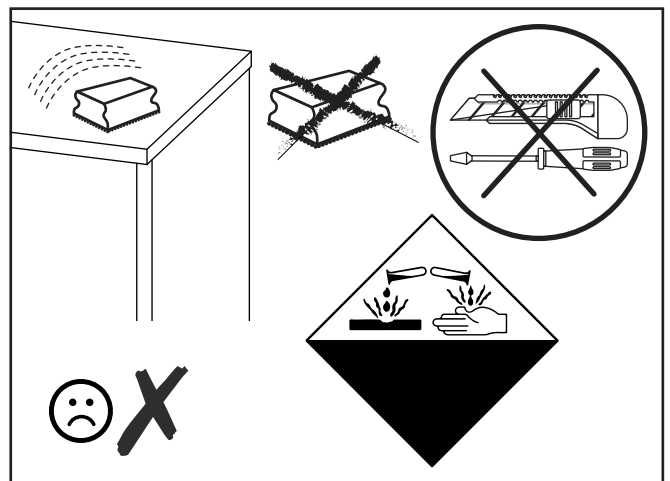
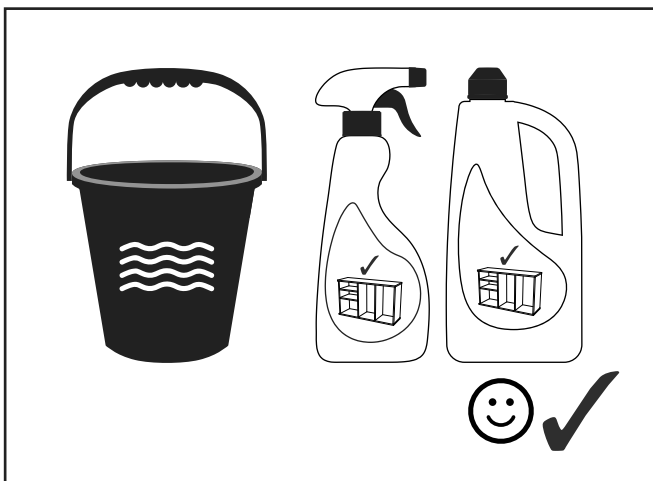
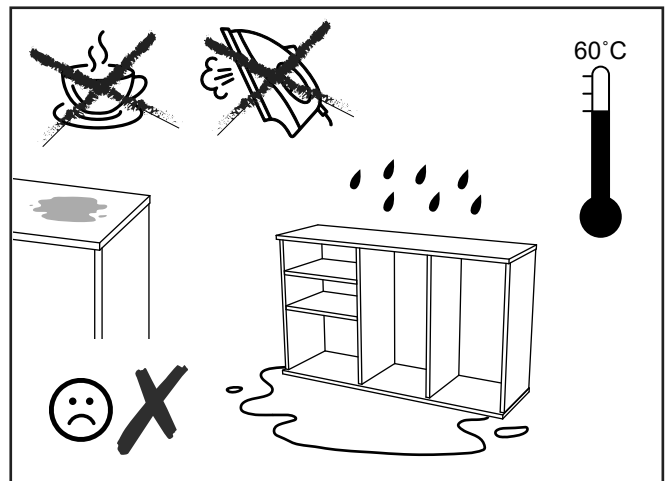
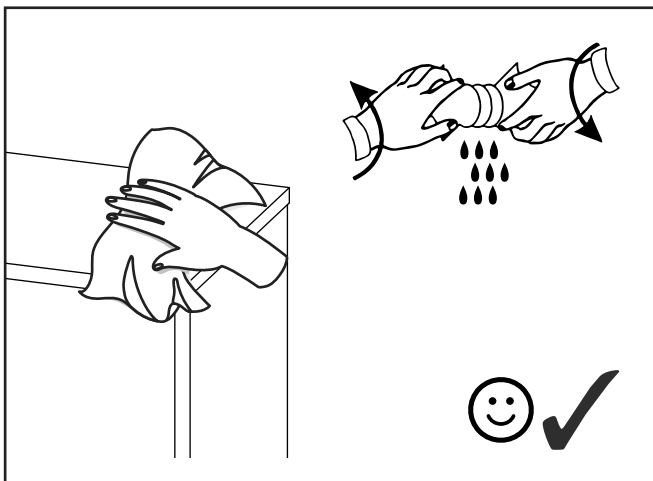
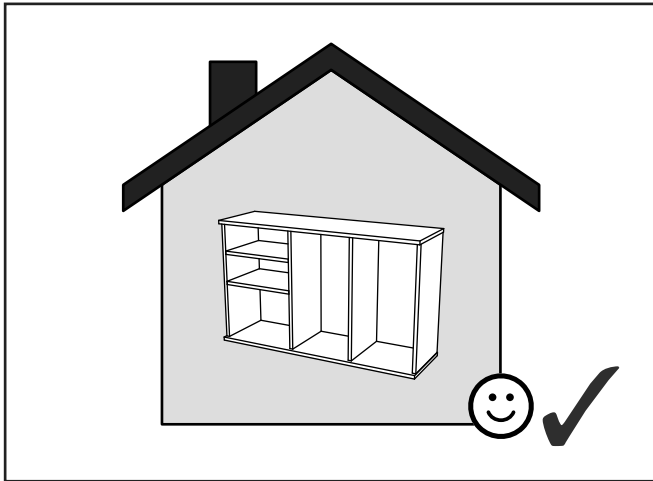

- PL** Powierzchnię mebli należy czyścić tylko środkami do pielęgnacji mebli. Szanowny kliencie w przypadku reklamacji prosimy wypełnić druki reklamacyjne dostępne w punktach sprzedaży przedkładając Kartę Reklamacyjną (zawierającą datę produkcji i numer pakowacza lub zmiany pakowania) umieszczona w każdej z paczek, oraz instrukcję montażu mebla, gdzie prosimy o zaznaczenie uszkodzonego elementu.
- SK** Povrch nábytku čistite iba prostriedkami určenými na ošetrovanie nábytku.Vá ení zákazníci! V prípade reklamácie prosíme, aby ste vyplnili tlačivá, ktoré sú prístupné v obchodoch, predlo ili Reklamačný list (ktorý obsahuje dátum výroby a číslo baliča alebo číslo zmeny pri balení), ktorý sa nachádza v ka dom balení a návod na montáž nábytku, v ktorom označte poškodenú čas.
- CZ** Povrch nábytku čistěte pouze přípravky určenými k ošetřování nábytku.Vá ený zákazník, v případě uplatnění reklamace vyplňte prosím reklamační formuláře, které jsou dostupné v prodejnách a předlo te Reklamační kartu (obsahující datum výroby a číslo balení nebo změny balení, která je umístěna v balíčku) a návod k obsluze s vyznačením poškozeného dílu.
- BG** Повърхността на мебелите трябва да се почиства само с препарати за поддържане на мебели.Уважаеми клиенти, в случай на рекламация моля попълнете формулярите за рекламация, които ще получите в търговските пунктове, като представите Картата за рекламация (съдържаща датата на производство и номера на опаковчика или смяната за опаковане), която ще намерите във всяка опаковка, и инструкцията за монтаж на мебела, върху която да отбележите повредения елемент.
- RO** Suprafața ei trebuie să fie curățată numai cu substanțe destinate pentru curățarea mobilei.Stimate Cumpărător, în caz de reclamație vă rugăm să completați formularul de reclamație pe care îl puteți lua de la punctul de vânzare și pe care îl veți prezenta împreună cu Cartela de Garanție (care conține data producției și nr ambalatorului sau turei de ambalare), însoțită la fiecare ambalaj, precum și instrucțiunile de montaj ale mobilei, pe care vă rugăm să marcați elementul deteriorat.
- UA** Поверхню меблів потрібно чистити тільки засобами для догляду за меблями.Шановний клієнте для заяви рекламачії, просимо заповнити формуляр рекламачії, доступний у пунктах продажу, вказуючи рекламачійну карту (містить дату виробництва та номер пакувальника або зміни упаковки), прикладену до кожного пакету, а також інструкцію з монтажу меблів, на якій просимо позначити пошкоджений елемент.
- RUS** Поверхность мебели надо чистить только средствами для ухода за мебелью.Уважаемый клиент для заявления рекламации, просим заполнить формуляр рекламации, доступный в пунктах продажи, указывая Рекламационную карту (содержащую дату производства и номер упаковщика или смены упаковки), приложенную к каждому пакету, а также инструкцию по монтажу мебели, на которой просим обозначить поврежденный элемент.
- DE** Reinigen Sie den Möbelbereich nur mit Möbelpflege. Kunden, bei Beanstandung Bitte füllen Sie die Reklamationsformulare, die in den Verkaufsabteilungen erhältlich sind, vor dem Verkauf aus eine Reklamationskarte (mit Angabe des Produktionsdatums und der Anzahl der Personen, die die Waren verpacken, oder der Anzahl der Schichten)Verpackung), die in jeder Packung enthlten ist, und Halterungen, in denen Sie reichlich vorhanden oder beschädigt sind ElementeReinigen Sie den Möbelbereich nur mit Möbelpflege. Kunden, bei Beanstandung.
- GB** Furniture surface must be cleaned only with furniture maintenance formulas.Dear Customer, should you wish to file a complaint, we would request you to fill in the complaint forms available in our outlets, submitting the Complaint Card (specifying the date manufactured, packaging employee/ shift code) enclosed in each of the packets, together with the Assembly Manual, where please highlight the faulty component.
- H** A bútorok felületét kizárólag a bútorápolószerekkel lehet tisztítani. Tisztelt Vásárló! Reklamáció esetén kérjük az eladási helyeken kapható reklamációs nyomtatványokat kitölteni a Reklamációs Lap (tartalmazza a gyártási dátumát és csomagoló számát vagy műszakszámát) bemutatásával, amely mindegyik csomagban található, valamint a bútor szerelési utasítását, amelyen kérjük a sérült elemet bejelölni sziveskedjék.
- FR** La surface des meubles ne peut être nettoyée qu'avec des produits pour l'entretien de meubles. Cher Client, en cas de réclamation, veuillez bien remplir des formulaires de réclamation accessibles dans les centres de vente en montrant le mode d'emploi pour monter le meuble. Nous vous demandons de bien vouloir y entourer l'élément en panne.
- ES** Limpiar la superficie de muebles exclusivamente con los agentes para el cuidado de los muebles.Estimado Cliente, en caso de reclamaciones, hagan favor de rellenar los formularios de reclamación disponibles en los puntos de venta, presentando las instrucciones de montaje de mueble, donde es necesario indicar un elemento estropeado.
- NL** Het oppervlak van meubels hoeft alleen te worden gereinigd door middel van meubelverzorging Beste klant voor de verklaring!
klacht, vul dan het klachtenformulier in dat beschikbaar is in de verkooppunten, met vermelding van: klachtenkaart (bevat de fabricagedatum en het nummer van de verpakker of verandering van verpakking), bevestigd aan elk pakket, evenals instructies voor het installeren van meubels, die we u vragen te markeren beschadigd item.