

1

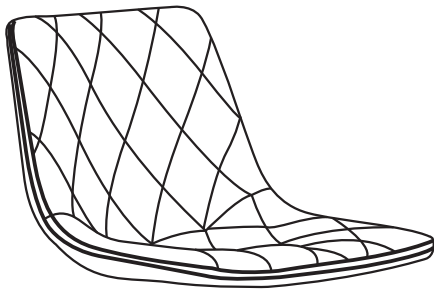

2

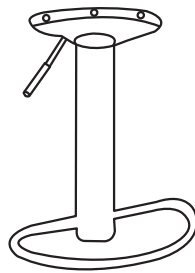

3



4

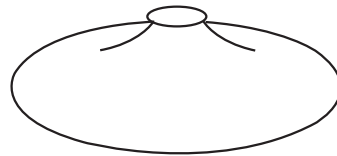

1	1x
2	1x
3	1x
4	1x



1/1

A



1x

B

M6X16



2x

C

M6X25



2x

D

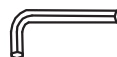



1x

I.

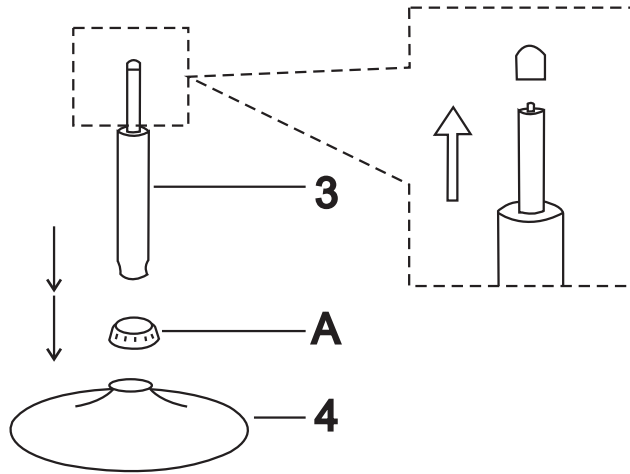
1.





A  1x



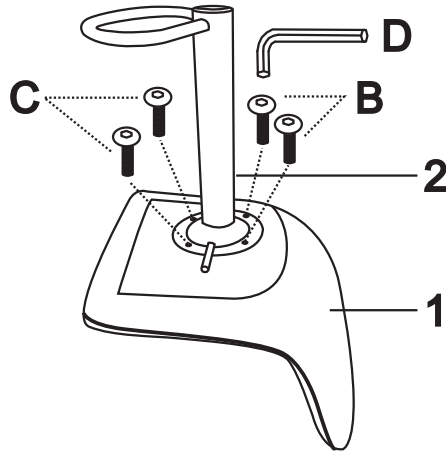

2.



B  M6X16 2x

C  M6X25 2x

D  1x



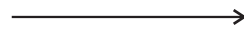

3.

