

1

2

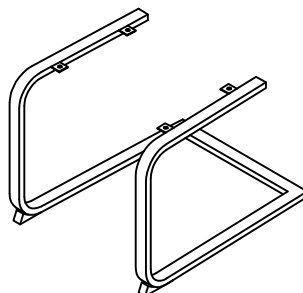

1	1X
2	1X

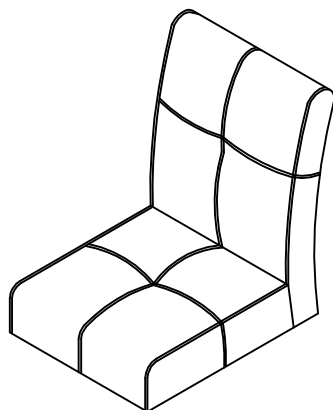

1/1

A

M6*20



4X

B

Ø18*Ø6.5*1.5



4X

C

4mm

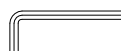



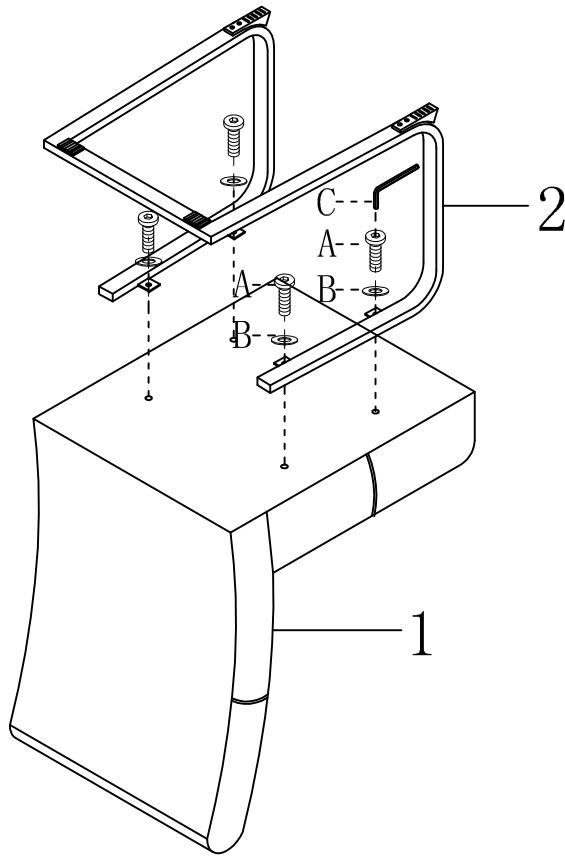

1X

I.



1.

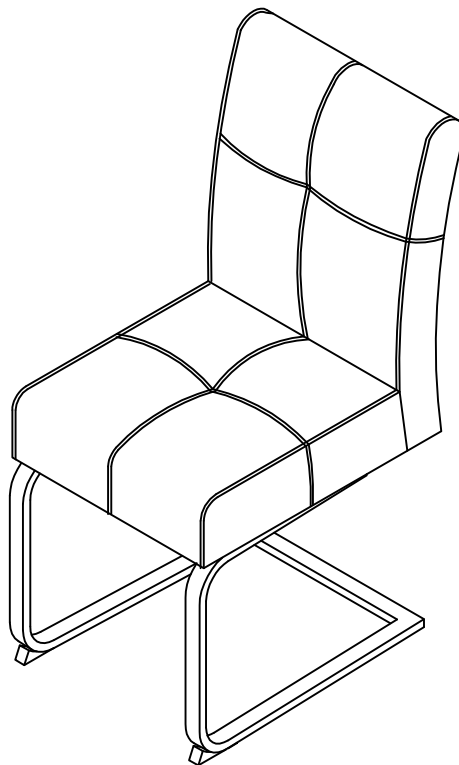

- A  M6*20
4X
- B  Ø18*Ø6.5*1.5
4X
- C  4mm
1X
-  75%

2.



- C  4mm
1X
-  100%

