

- |           |                                    |           |                                |
|-----------|------------------------------------|-----------|--------------------------------|
| <b>D</b>  | <b>Montageanleitung</b>            | <b>GB</b> | <b>Assembly instructions</b>   |
| <b>FR</b> | <b>Notice de montage</b>           | <b>IT</b> | <b>Istruzioni di montaggio</b> |
| <b>NL</b> | <b>Handleiding voor de montage</b> | <b>PL</b> | <b>Instrukcja montażu</b>      |
| <b>CZ</b> | <b>Montážní návod</b>              | <b>SK</b> | <b>Montážny návod</b>          |
| <b>HU</b> | <b>Szerelési útmutató</b>          | <b>RO</b> | <b>Instrukțiuni de montaj</b>  |
| <b>TR</b> | <b>Montaj talimatı</b>             | <b>RU</b> | <b>Инструкция по монтажу</b>   |

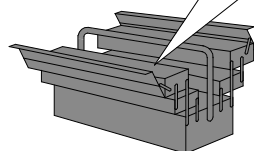
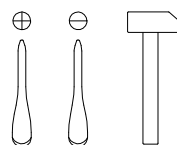
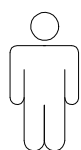

# Service · Dienstverlening · Serwis · Servis · Сервисная служба

Name · Název/Názov

Nr. · No. Číslo

Typ · Type · Tip · Тип

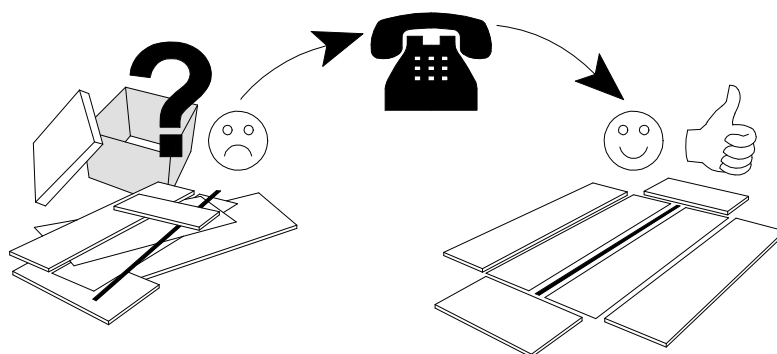
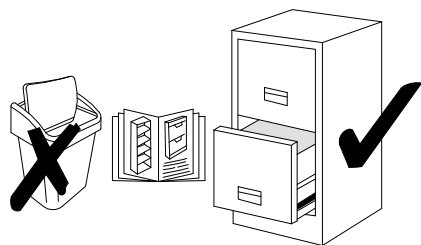

Č.	Rozměry/RozmeryMaB (mm)	Počet	✓
1	936×242	1	
2	1150×63	1	
3	1060×100	1	
4	100×68	2	
5	227×30	2	
6	1200×1060	1	

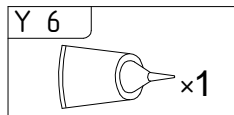
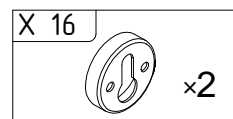
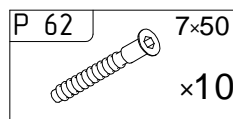
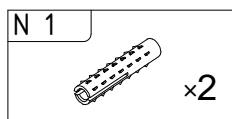
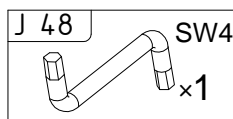
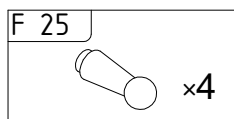
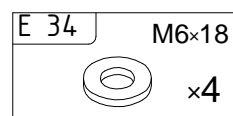
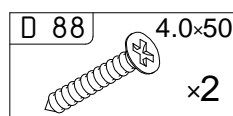
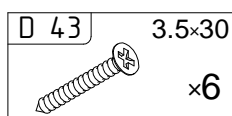
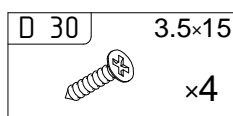
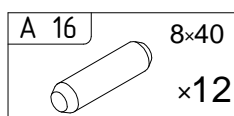

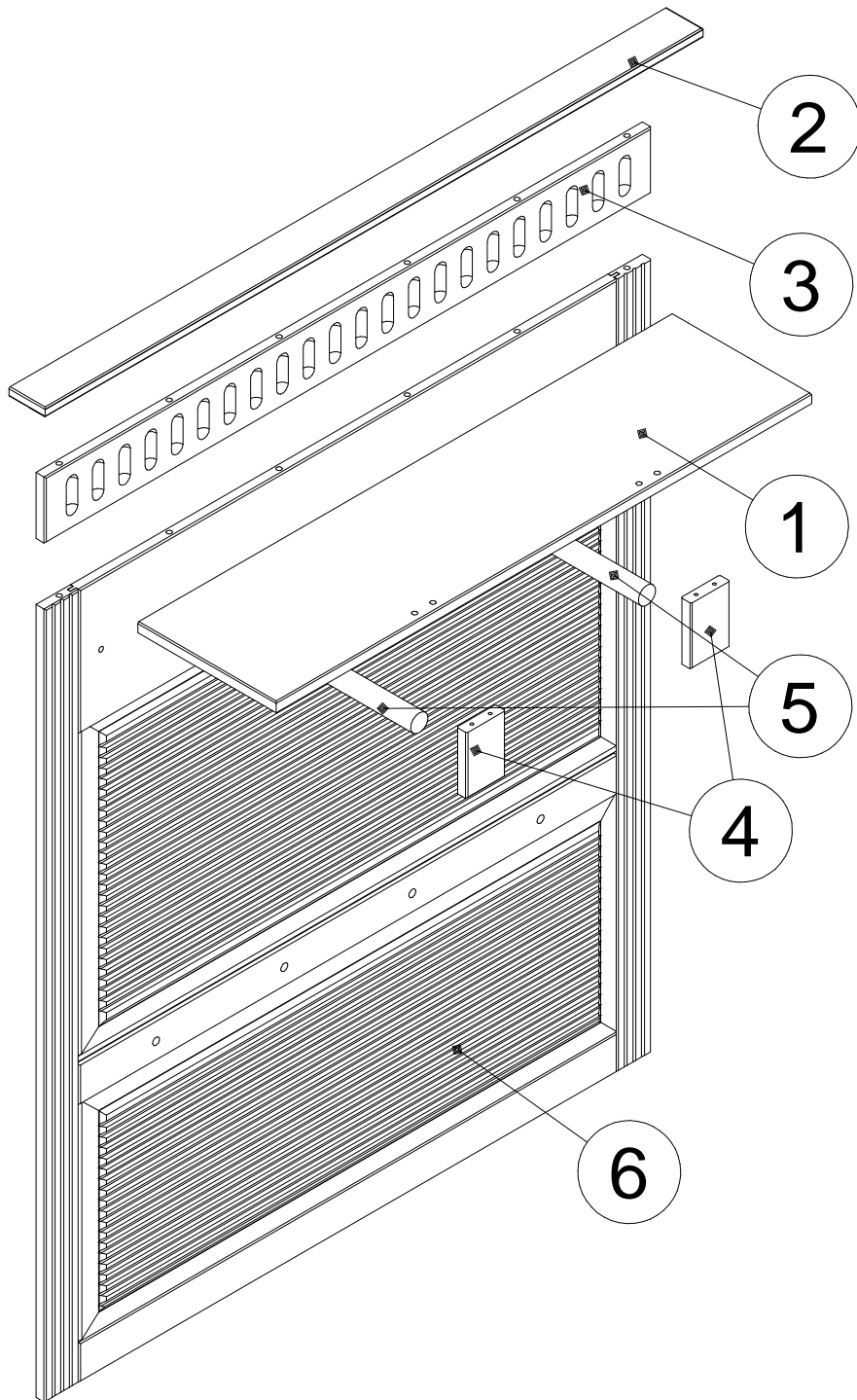
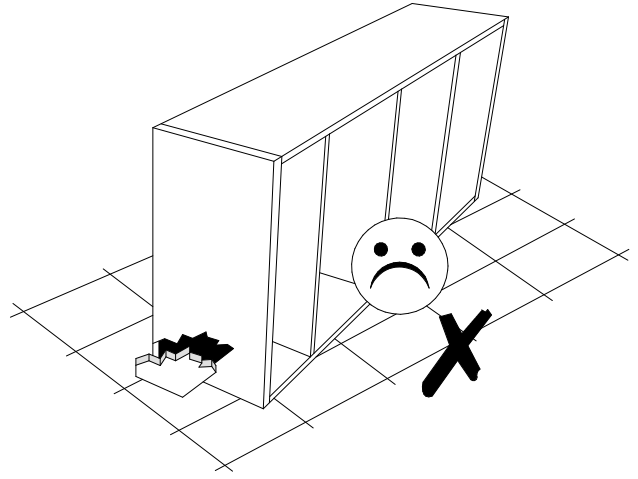
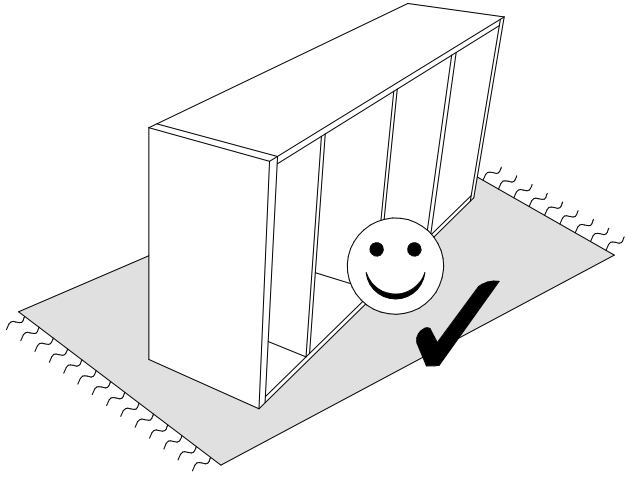



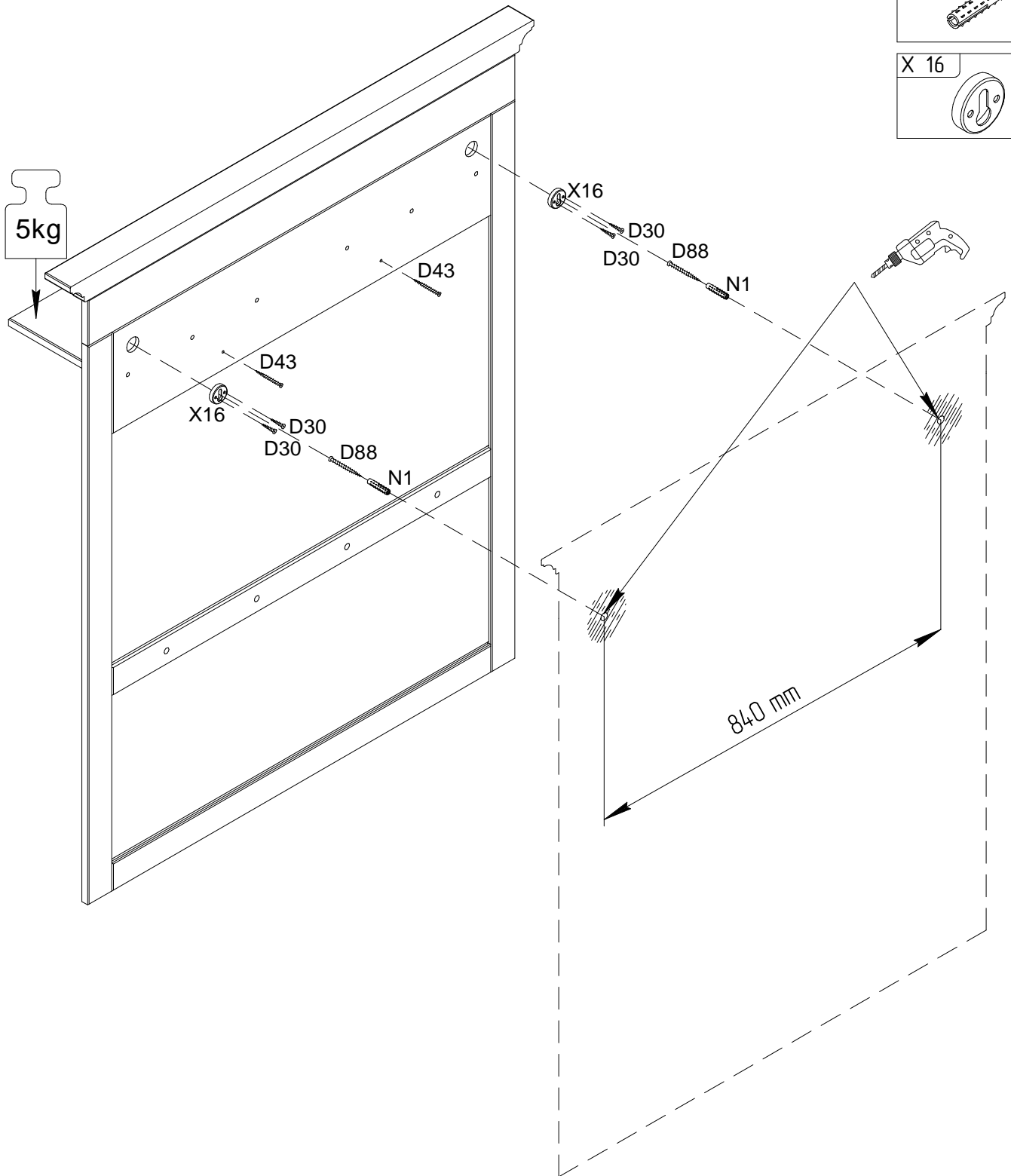
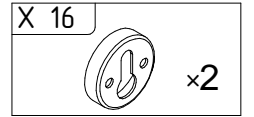
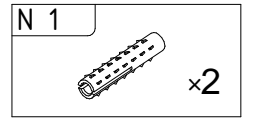
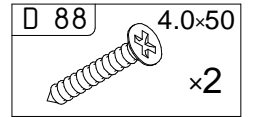
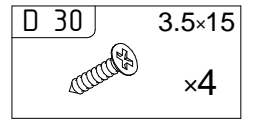
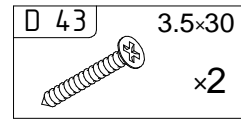



**Achtung • Attention • Attenzione  
Opgelet • Uwaga • Pozor • Figyelem  
Atenție • Dikkat • Внимание**



<b>(D)</b>	Wandbefestigung dient als Kippschutz – unbedingt anbringen (rückläufig)! Bei einigen Wandtypen kann ein Spezialdübel erforderlich sein!
<b>(GB)</b>	The wall fastening serves to prevent tipping – be absolutely sure to mount it (falling)! For certain wall types, a special wall plug may be necessary!
<b>(FR)</b>	La fixation murale sert de protection contre le basculement – à installer impérativement (chute) ! Pour certains types de murs il faut des chevilles spéciales !
<b>(IT)</b>	Il fissaggio alla parete serve da protezione anti-ribaltamento – attaccarla assolutamente (caduta)! Per alcune strutture di parete può essere necessario un tassello speciale!
<b>(NL)</b>	Bevestiging aan de muur dient als kantelbescherming – zeker en vast bevestigen (vallend)! Bij enkele muurtypes is een speciale plug mis-schien vereist!
<b>(PL)</b>	Mocowanie do ściany jest jednocześnie zabezpieczeniem przed przewróceniem – koniecznie zamontować (spadanie)! Do niektórych rodzajów ścian koniecznie zastosować specjalne kołki mocujące.
<b>(CZ)</b>	Montáž na stěnu slouží jako ochrana proti převrhnutí – bezpodmínečně umístěte (padající)! U některých typů stěn může být zapotřebí speci-ální hmoždinka!
<b>(SK)</b>	Upevnenie na stenu slúži ako ochrana proti prevráteniu – bezpodmiennečne použite (padajúce)! Pre niektoré druhy stien môže byť potrebná špeciálna hmoždinka!
<b>(HU)</b>	A terméket a falhoz kel rögzíténi, különben az felborulhat (eső)! Egyes faltípusoknál speciális tiplit kell használni!
<b>(RO)</b>	Sistemul de fixare la perete servește ca protecție la răsturnare – de montat obligatoriu (cădere)! Pentru unele tipuri de pereți este posibil să fie necesar un diblu special!
<b>(TR)</b>	Duvardaki sabitleme, devrilmeye karşı bir emniyet tedbiridir ve mutlaka monte edilmelidir (düşen)! Bazı duvar tiplerinde bunun için özel bir dübel gerekli olabilir!
<b>(RU)</b>	Обязательно установите крепление на стене во избежание опрокидывания (падения)! Для некоторых типов стен может потребоваться специальный дюбель!