

13

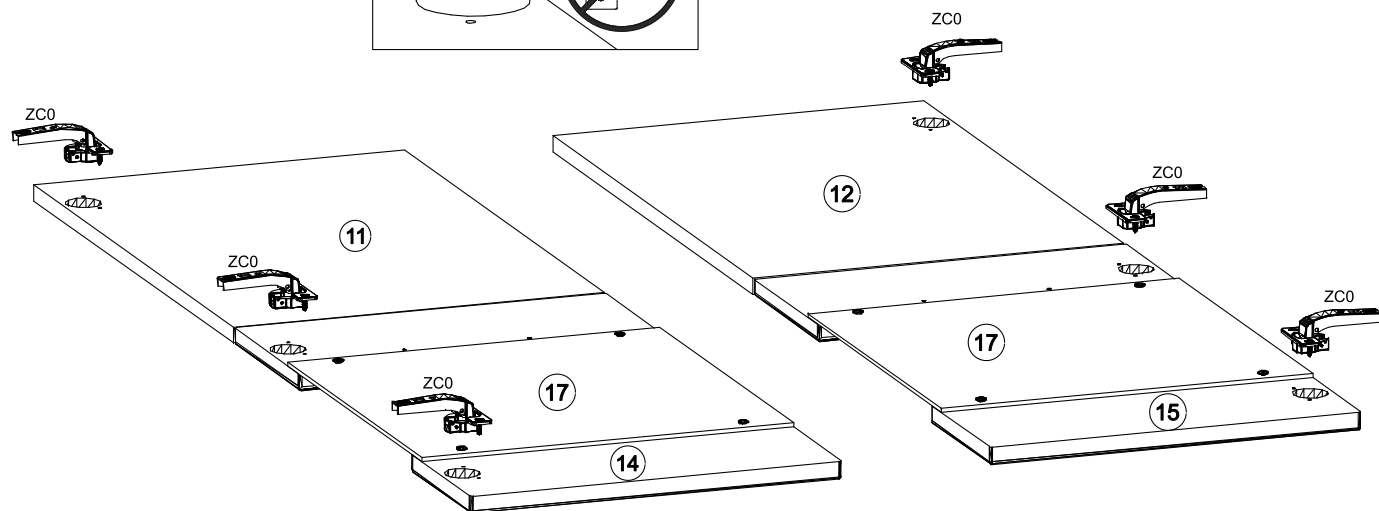

14

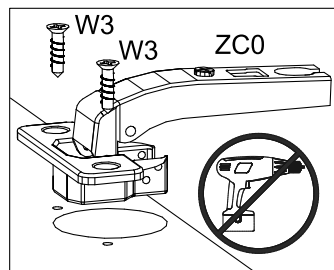
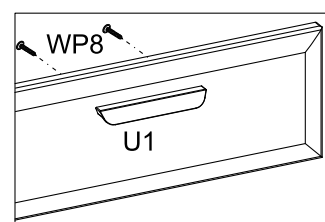
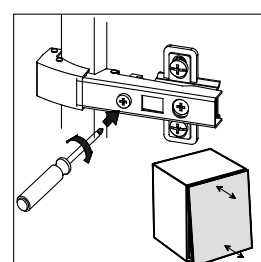
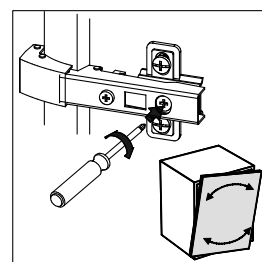
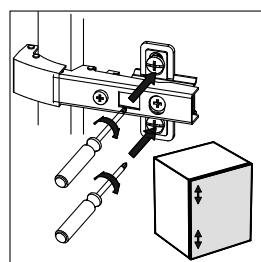
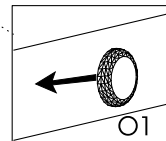
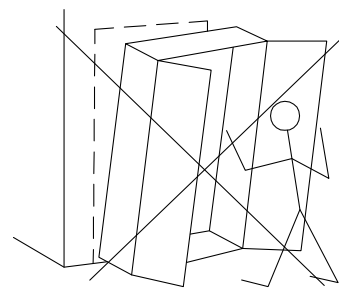
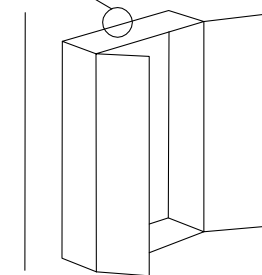
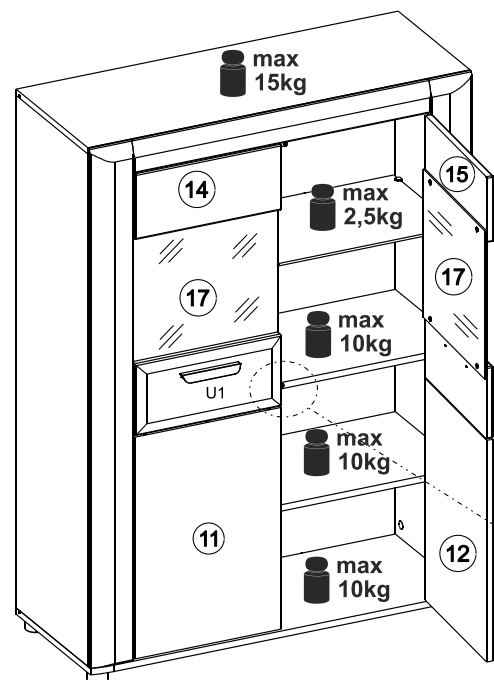
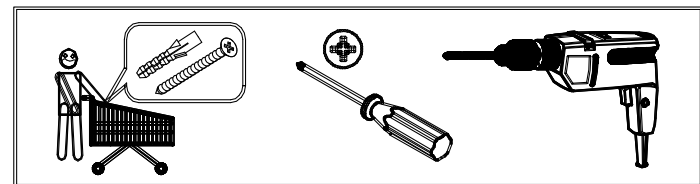
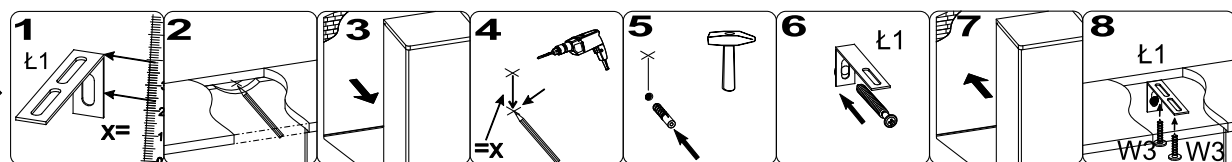

MODEL

BT04

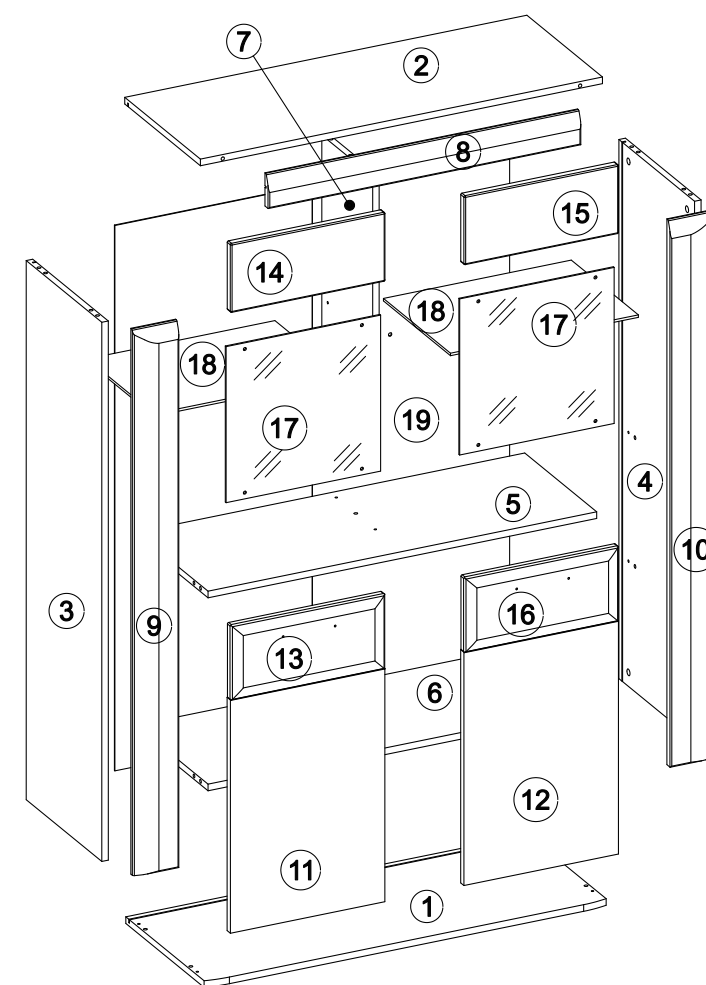
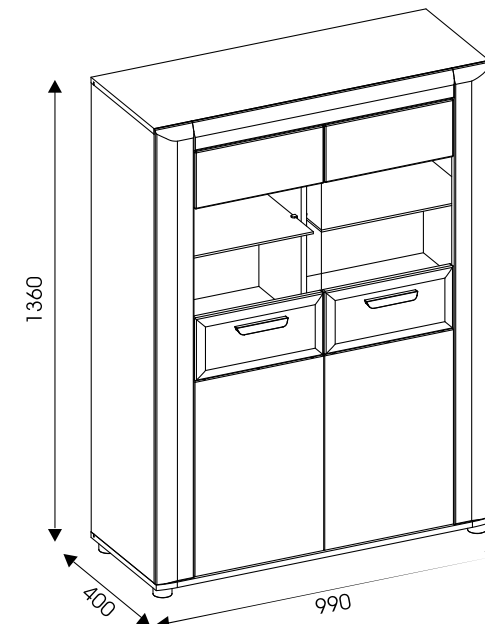
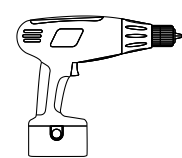
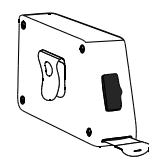
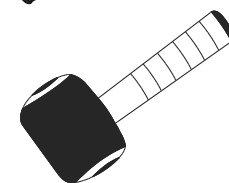
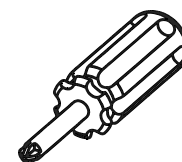
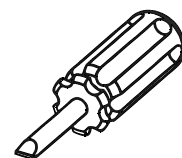
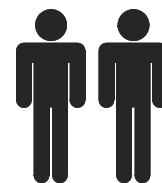
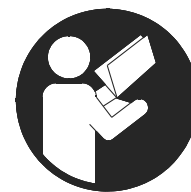

19	1314x971	3/3
18	462x330	3/3
17	376x380	3/3
16	380x182	3/3
15	380x166	3/3
14	380x166	3/3
13	380x182	3/3
12	562x380	3/3
11	562x380	3/3
10	1315x110	2/3
9	1315x110	2/3
8	769x80	3/3
7	679x250	1/3
6	956x354	1/3
5	956x354	1/3
4	1299x372	2/3
3	1299x372	2/3
2	989x372	1/3
1	989x392	1/3

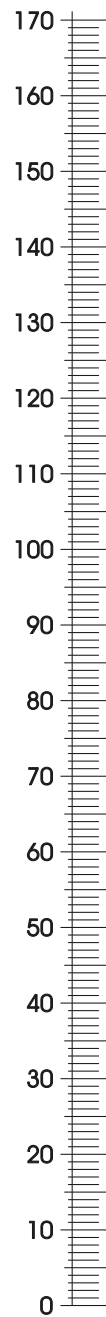

6x ZP3590 ZC0	2x UK394128S U1	4x 4.2x32 WP8	46x 3.5x16 WP5	2x MB12/12 M2	1x LK008121S L1	1x OPCJA 2xNSP-3D/WW	L1	
20x ZS020863F ZN1	14x 3.5x16 W3	14x WS000001X ST1	8x PS000001K B2	8x TS000001X TU1	14x 3x20 W9	6x PH200001R PR2	4x 4x25 WP3	4x ST025505B N1
4x OM000015X O1	18x 8x30 K1	2x DU645 T2	8x 4x16 WP6	20x MB15/15 M1	20x DU232T T1	11x KH000002X KH1	14x 2x20 G1	1x PM000001X R1

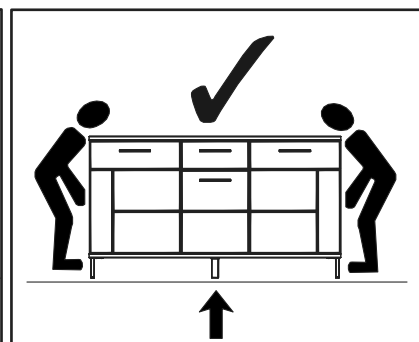
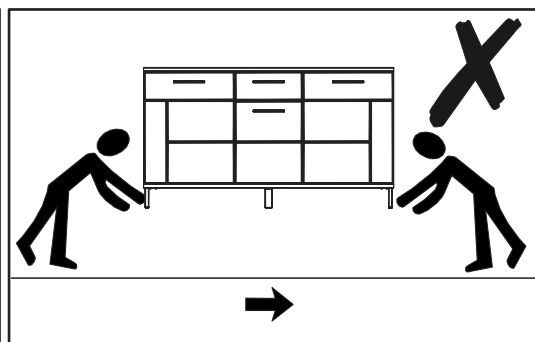
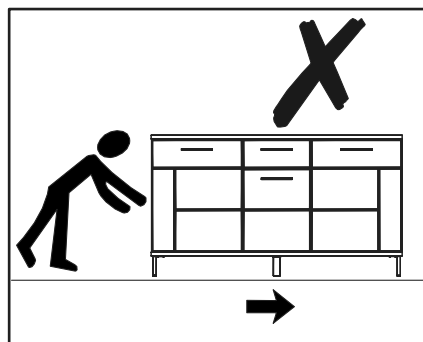
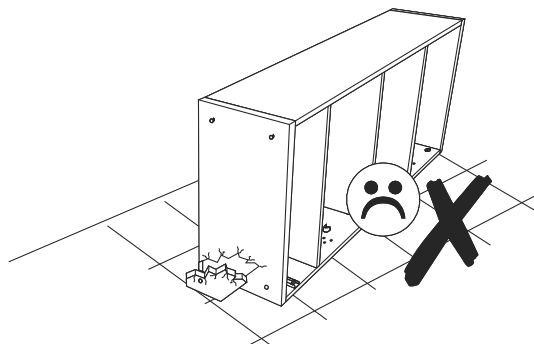
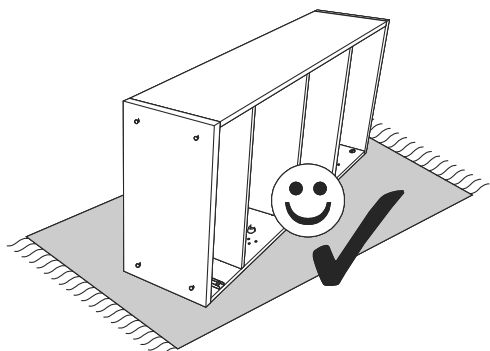
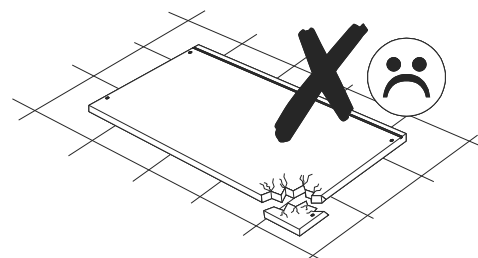
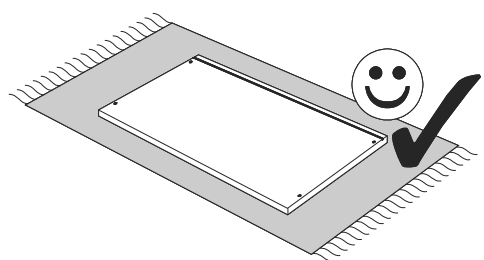
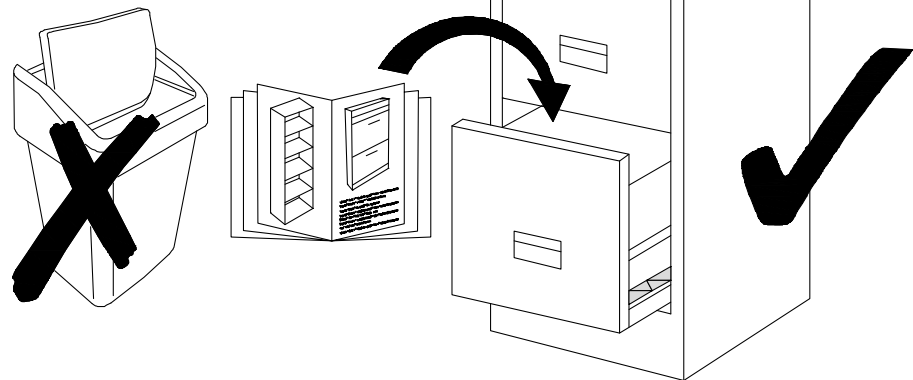

11▶

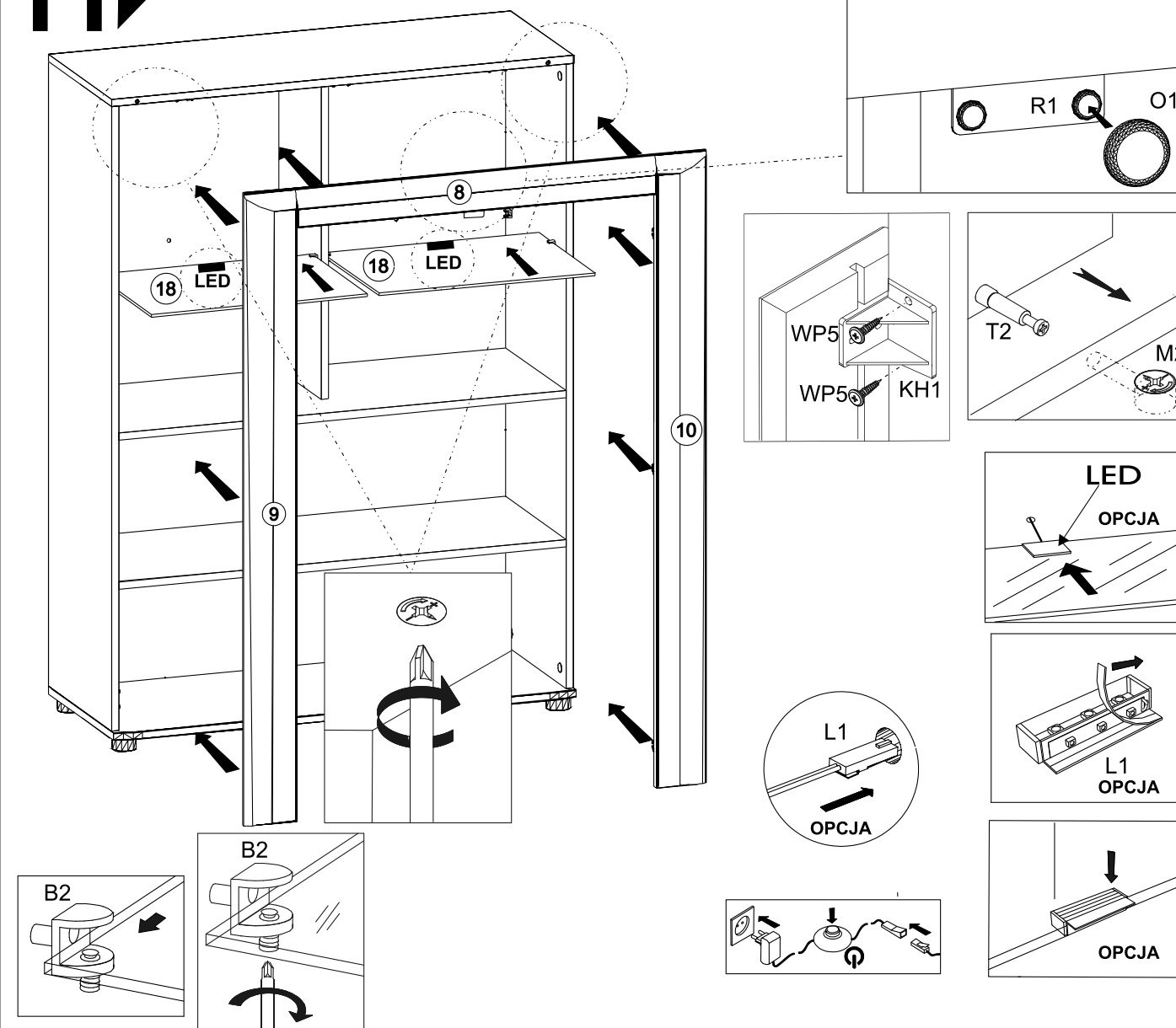

12▶

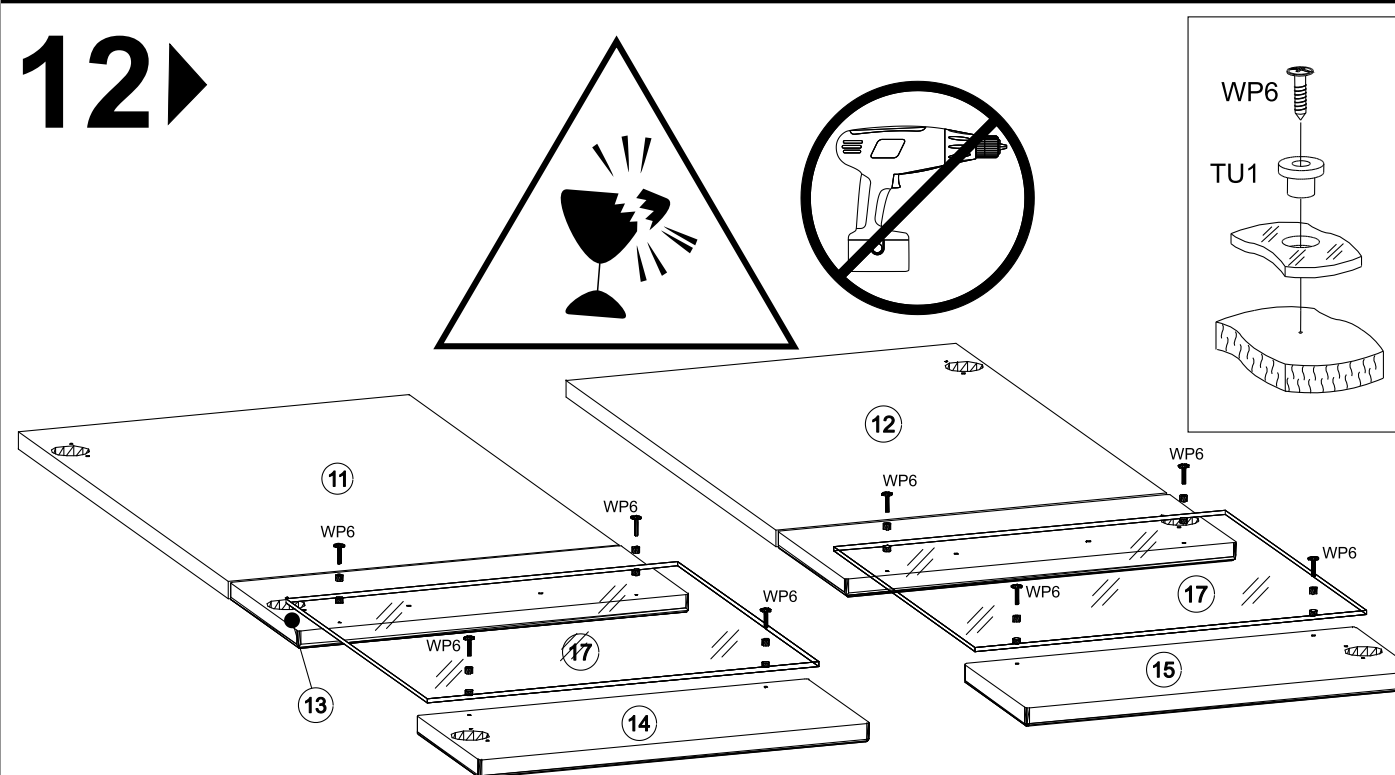

9

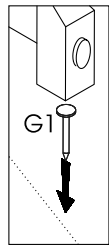
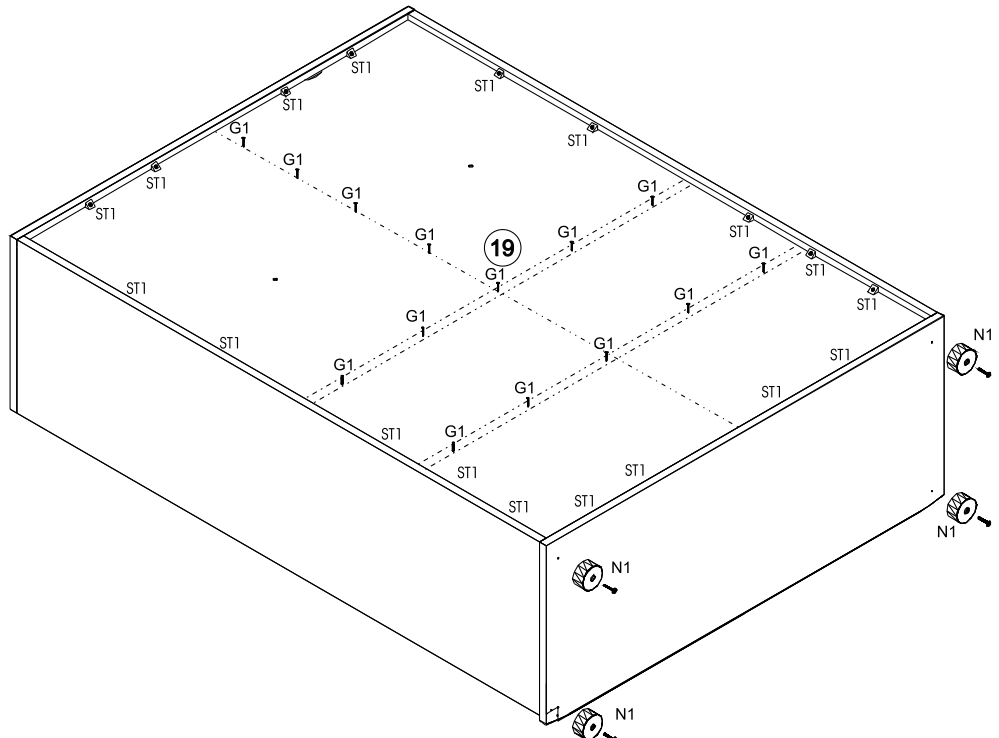
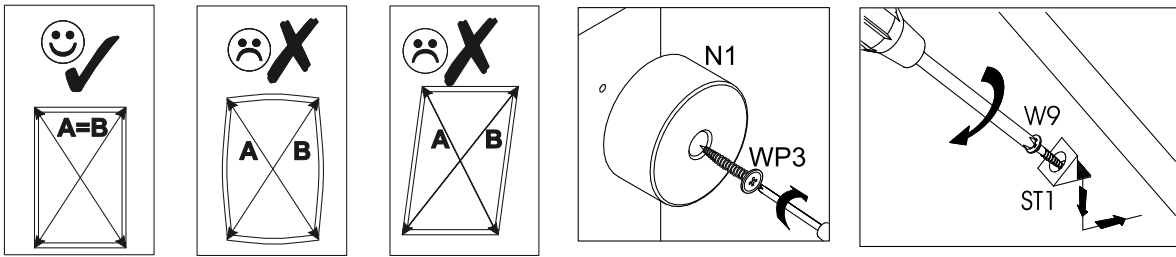

10

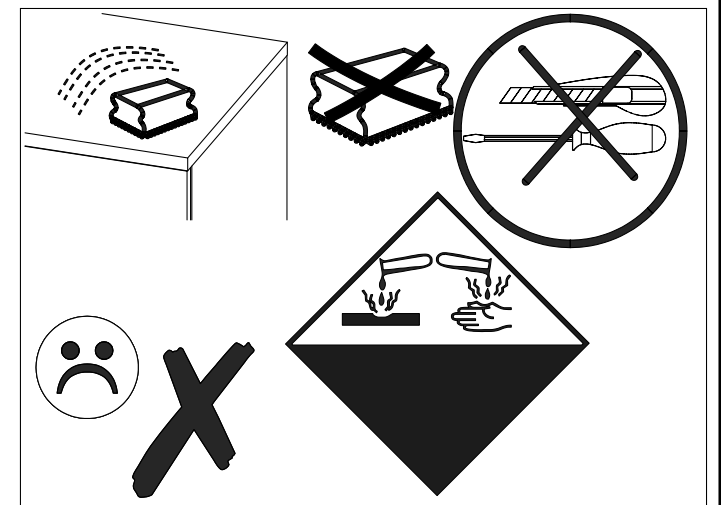
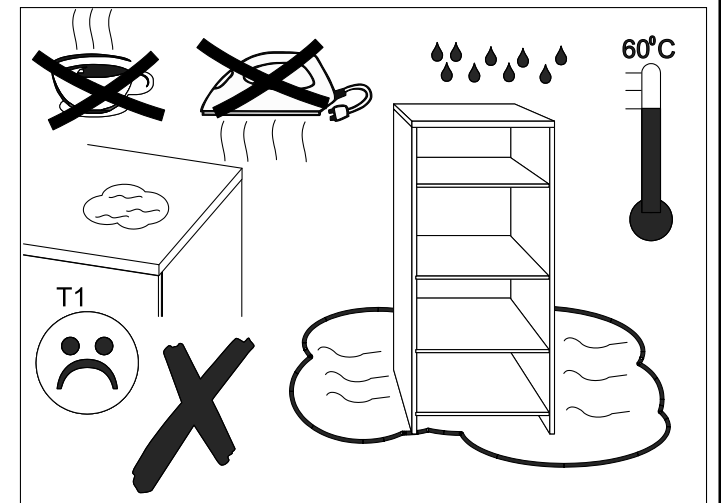
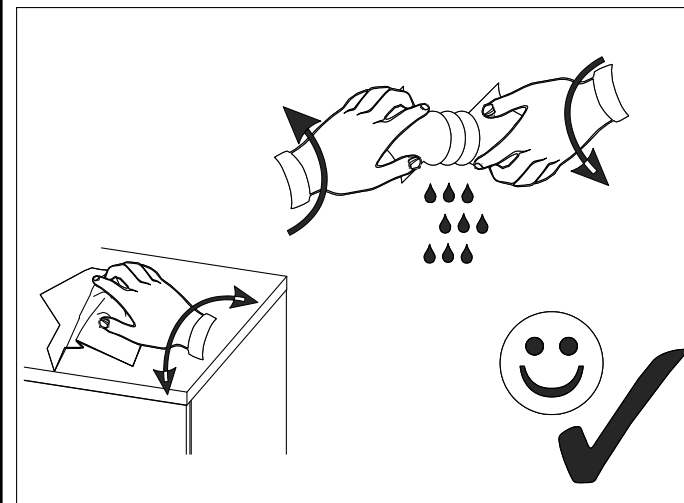
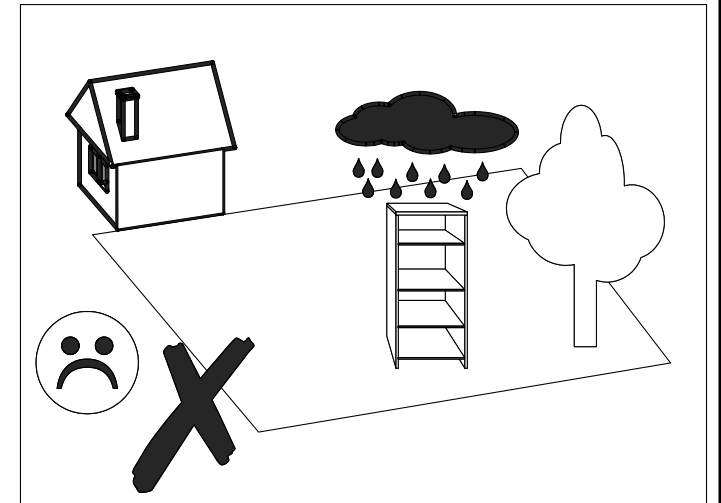
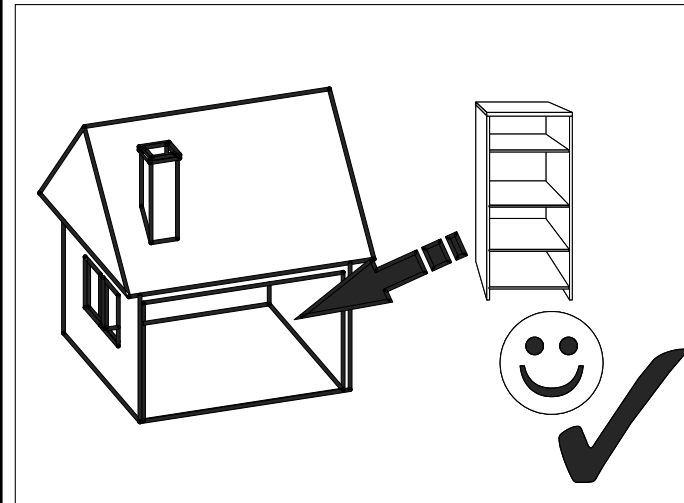
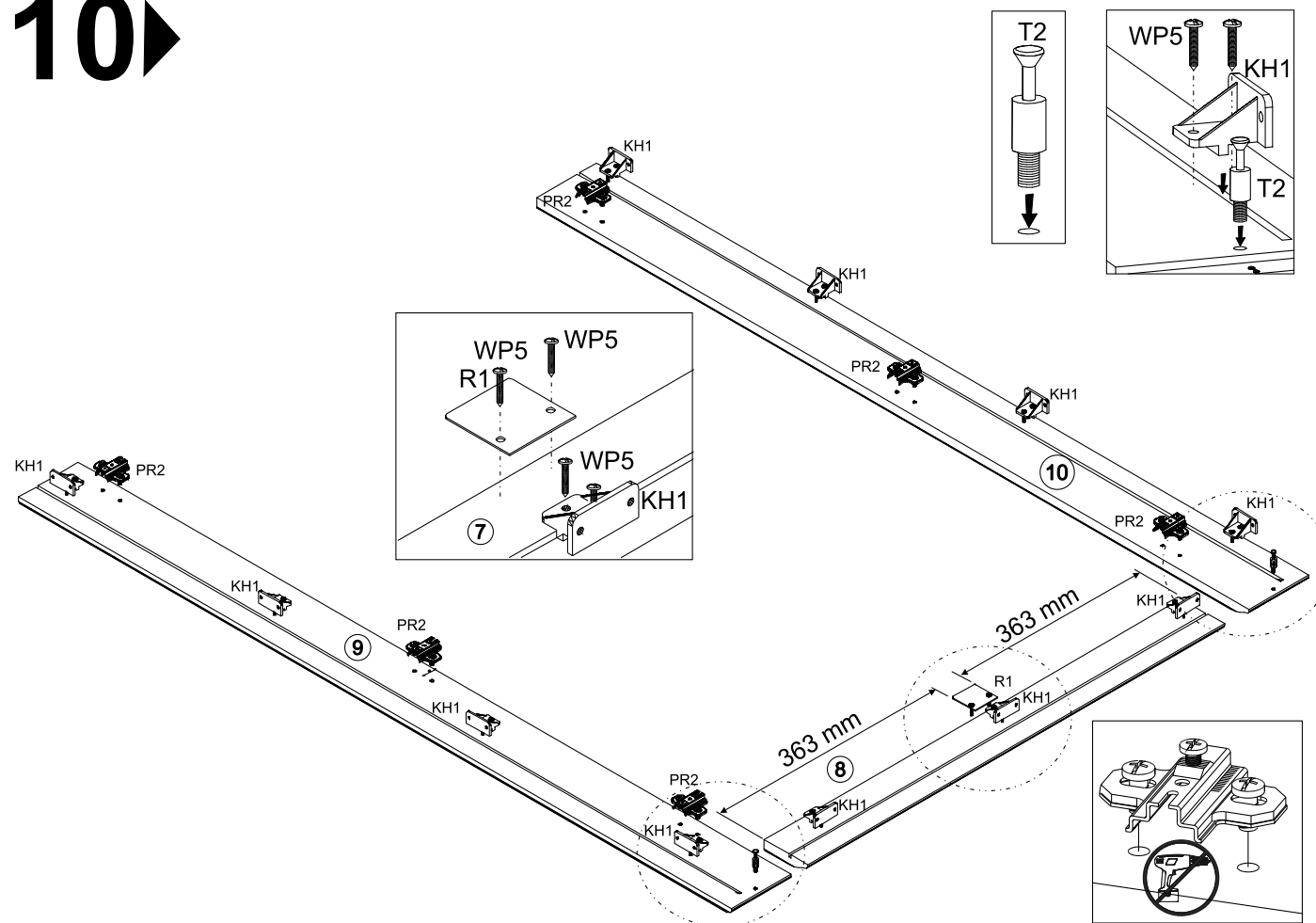

1

BT04

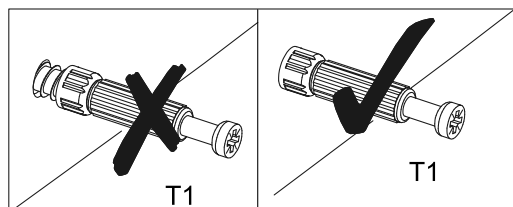
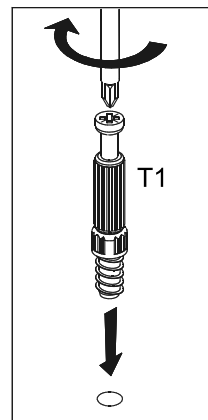
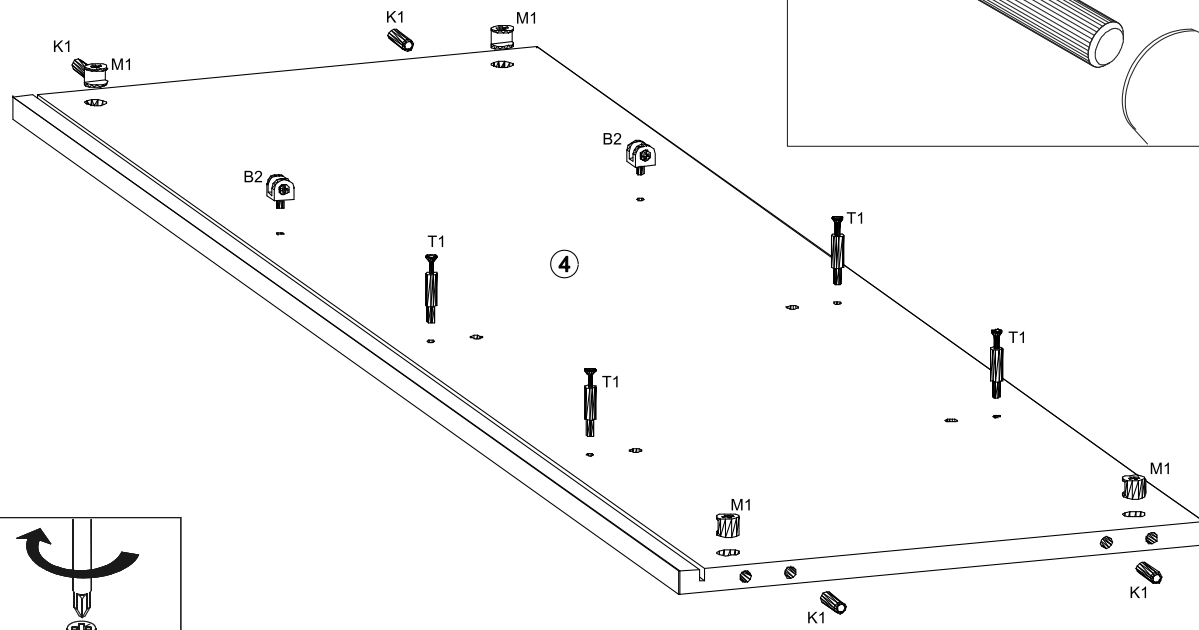
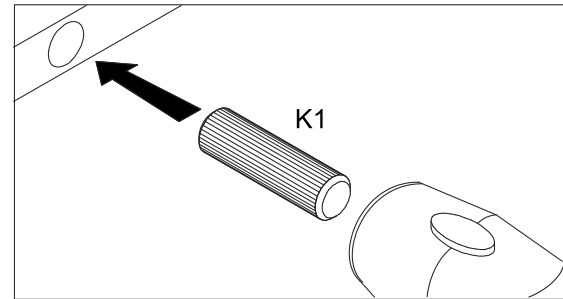
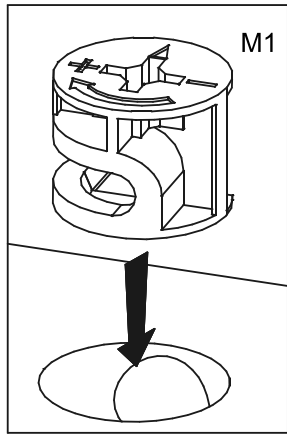
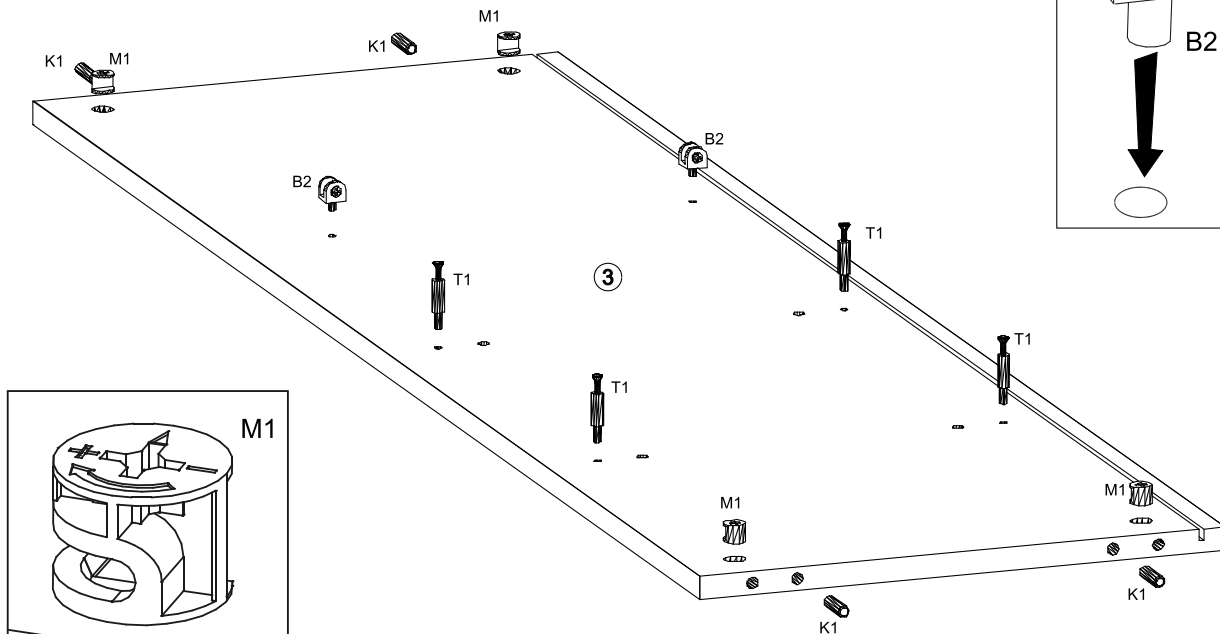
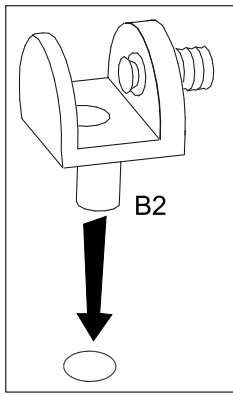

6

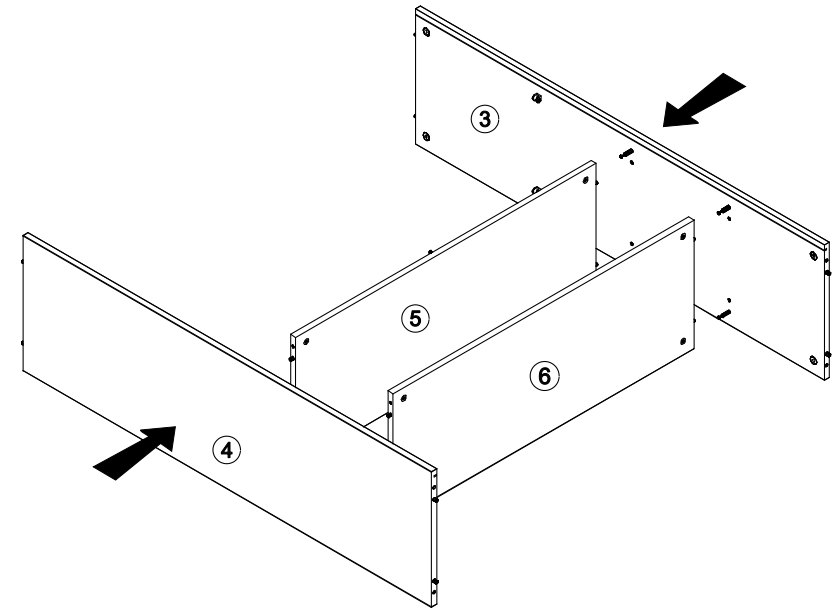

7

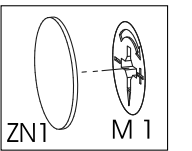
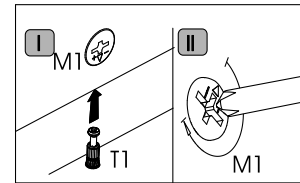
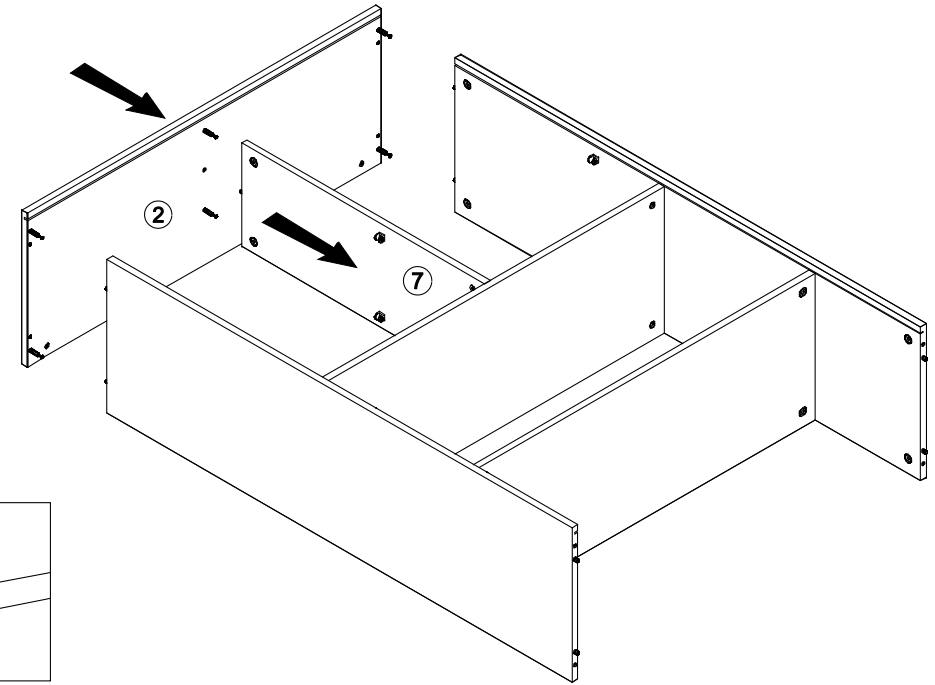

8

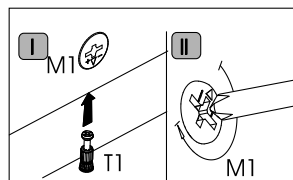
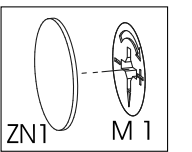
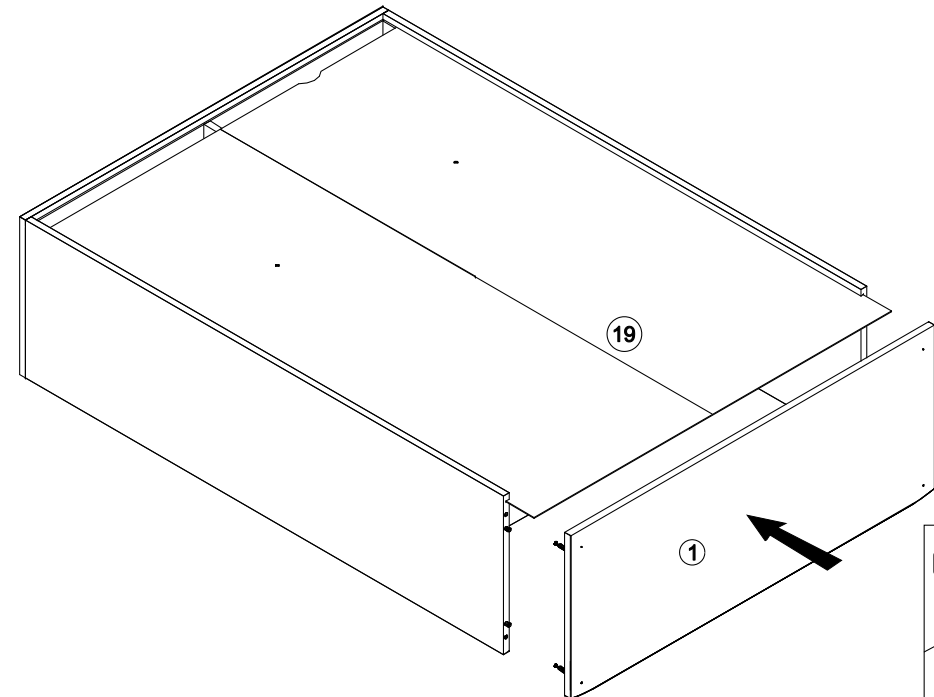

2

BT04

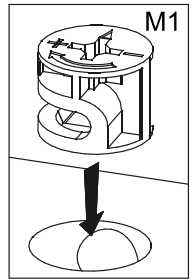
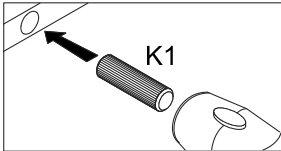
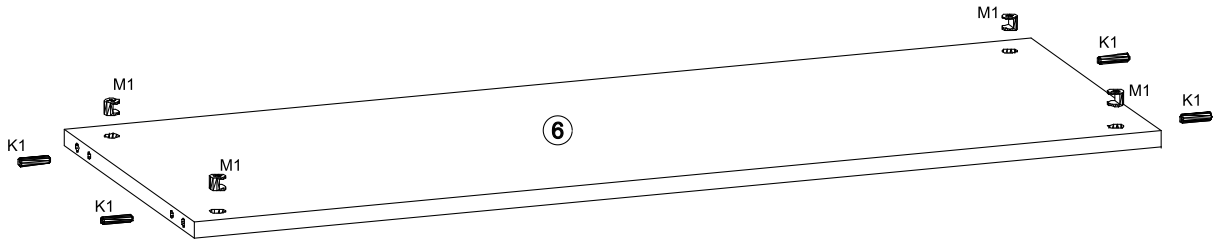

3

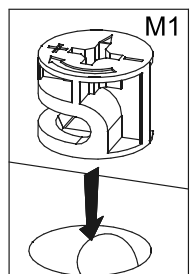
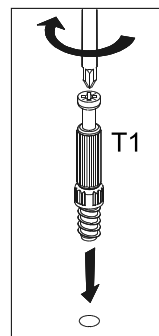
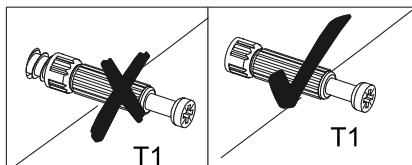
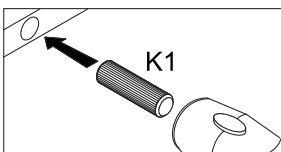
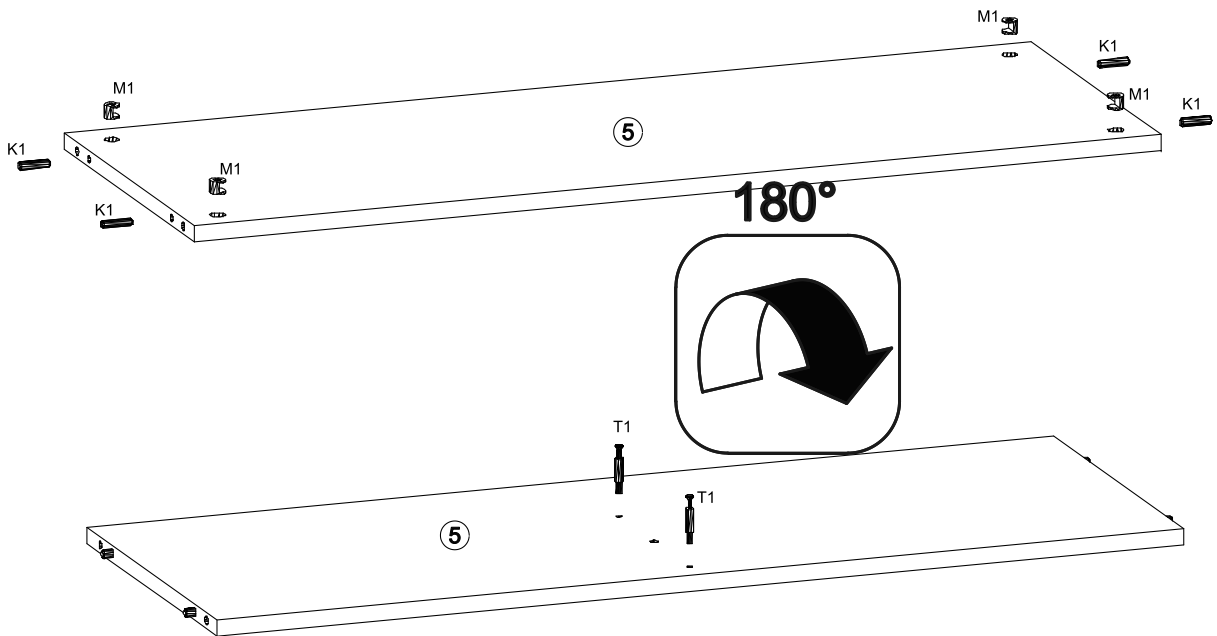

4

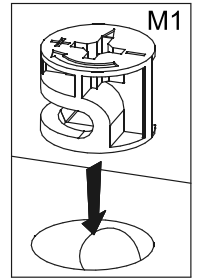
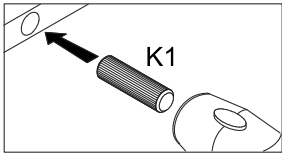
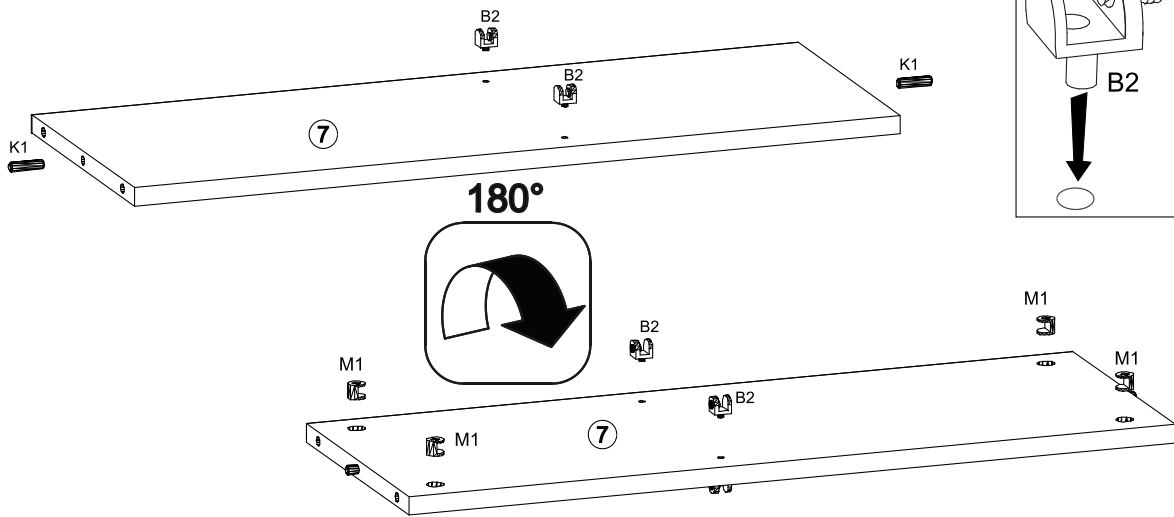

5

