

HOPE

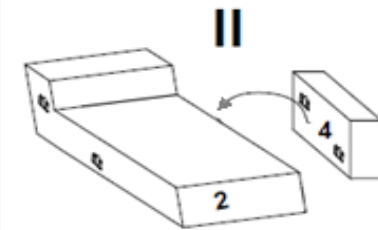

Pravá

I

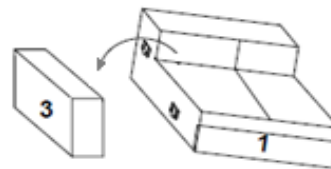

II

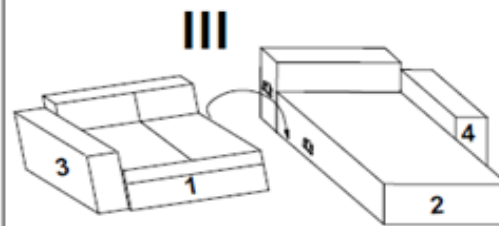
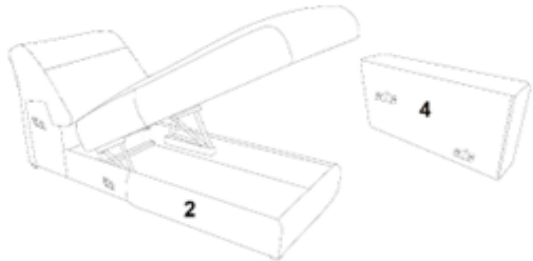

III

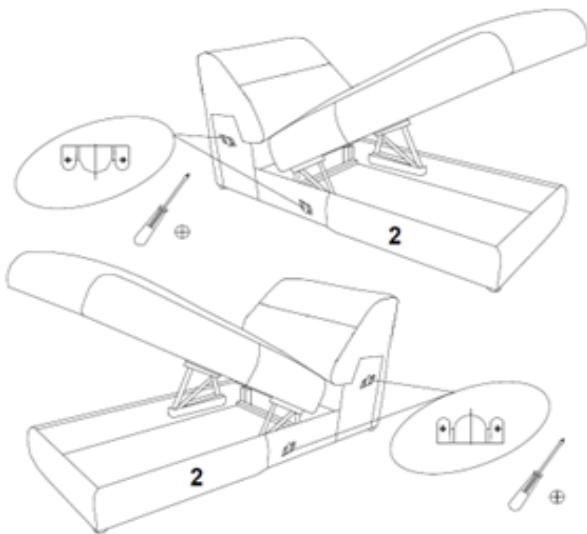
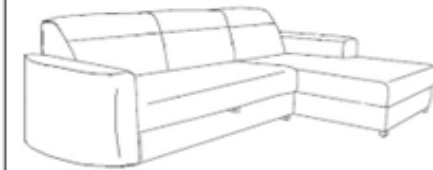

Levá/Ľavá

I

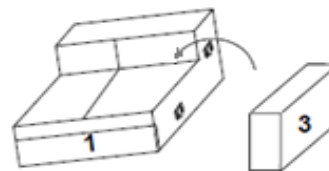

II

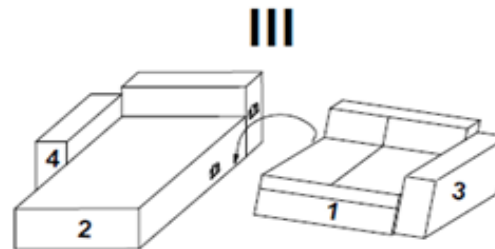
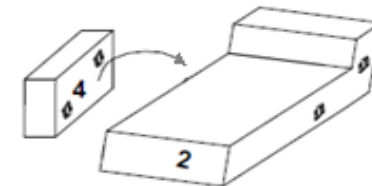

III

