

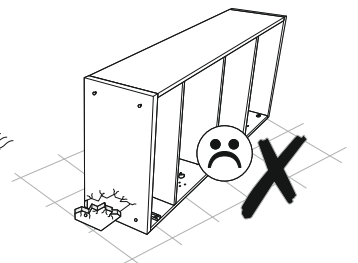

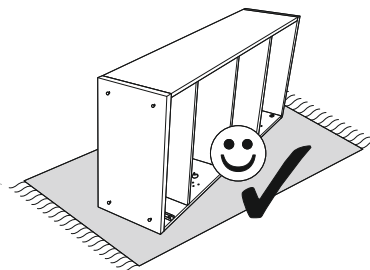

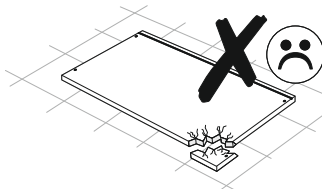

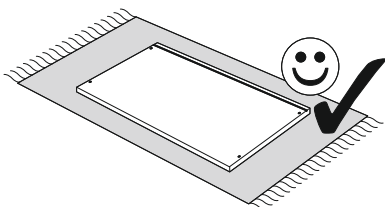
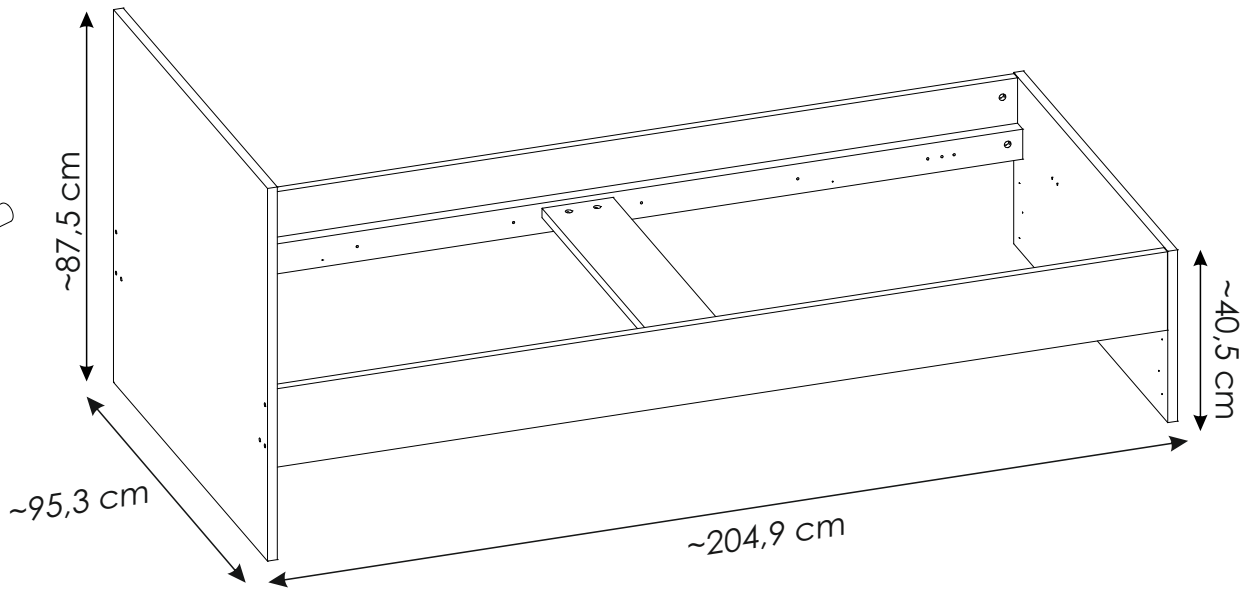
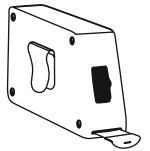
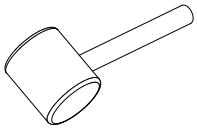
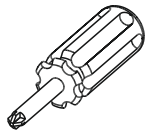
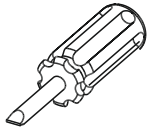
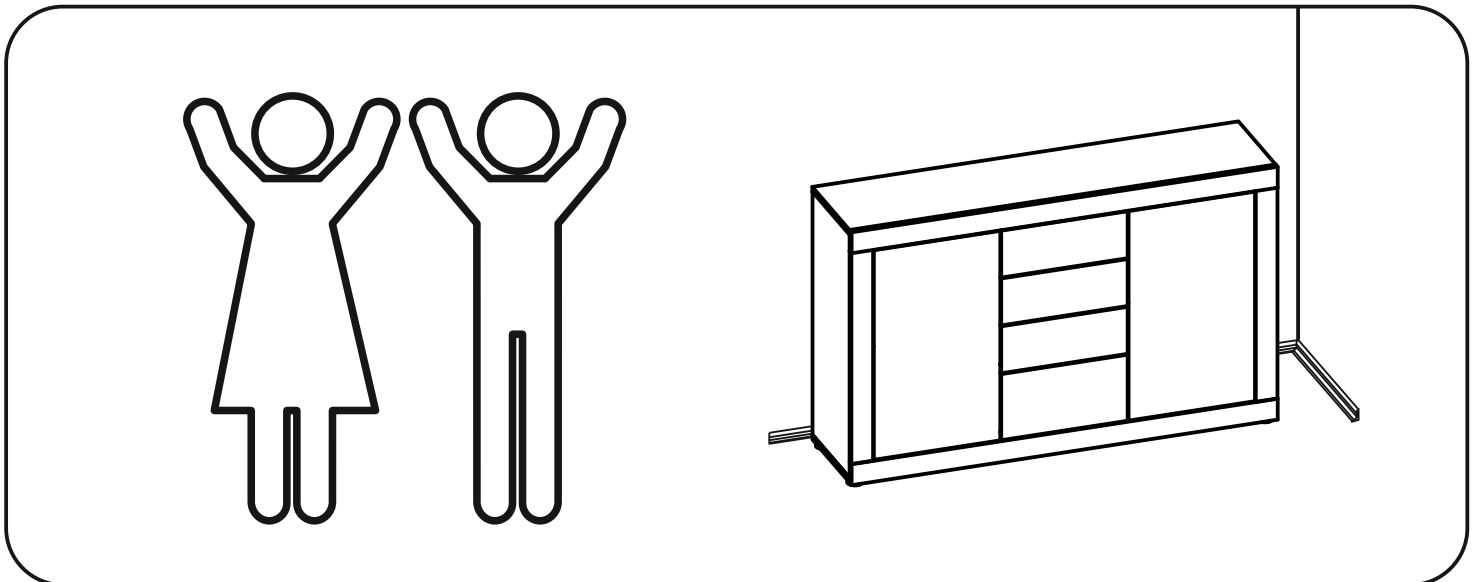
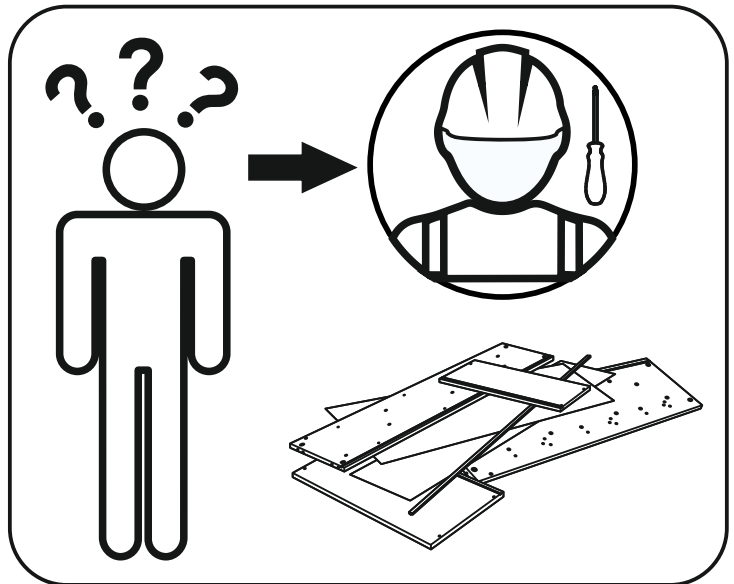
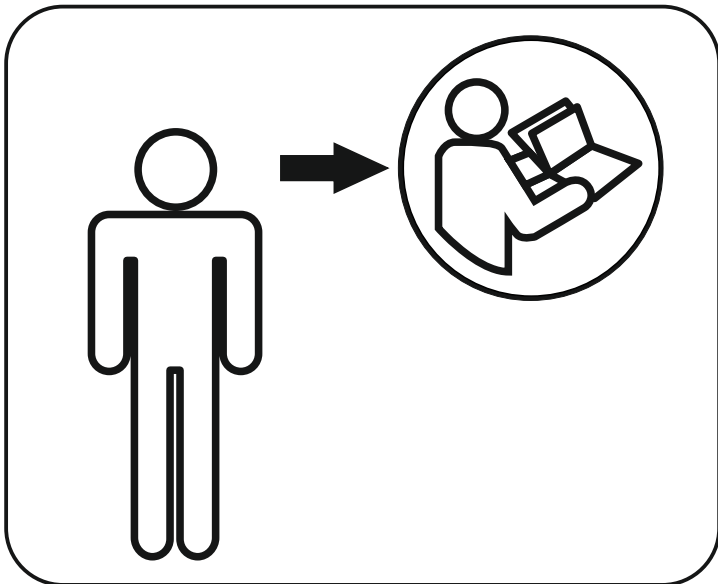
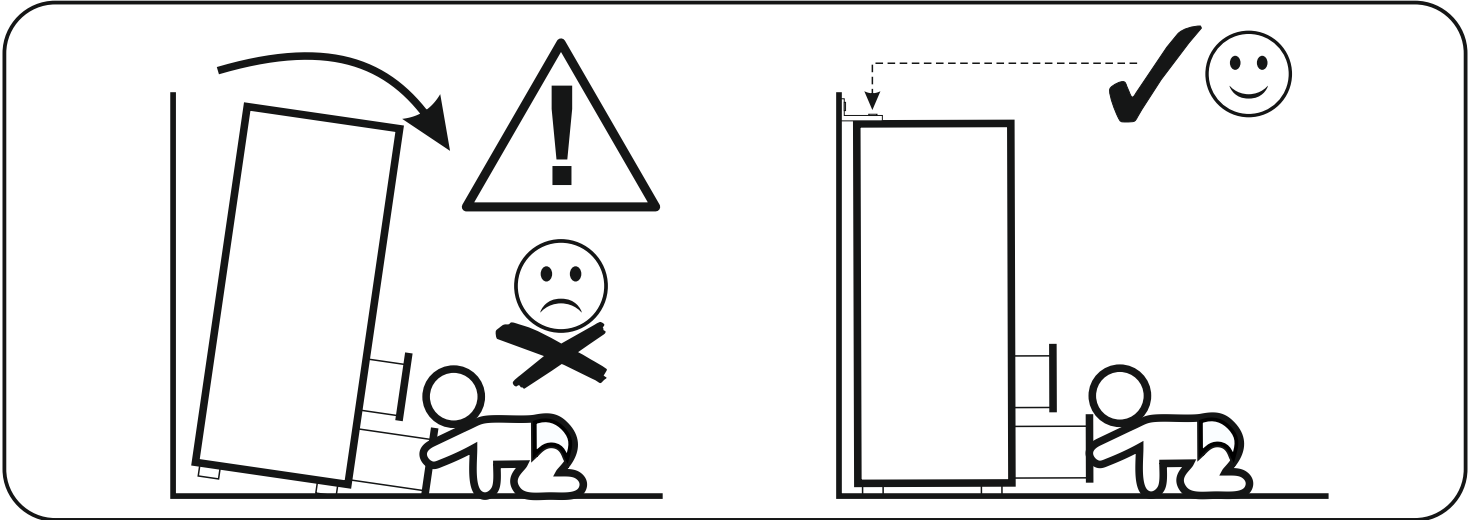
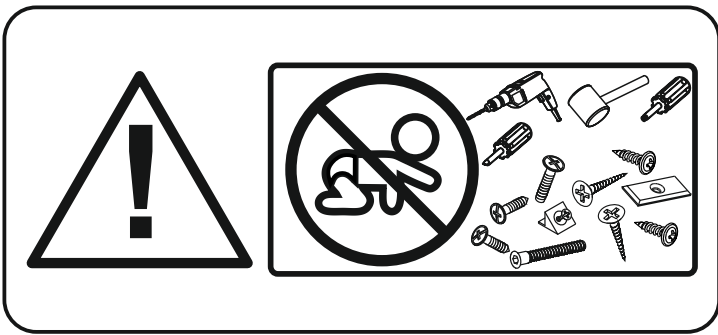
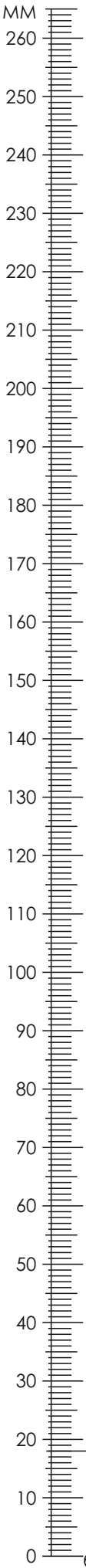

MRLZ01



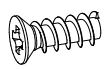

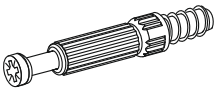
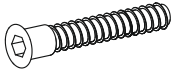
MRLZ01

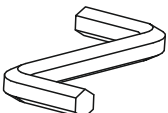
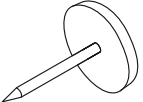

A1 8 x 35 mm x28 	C6 6,3 x 16 mm x16 	E1 15 x 12 mm x8 
F1 6 x 34 mm x8 	G1 7 x 50 mm x6 	I19 4 x 50 mm x12 
M x1 	O2 x6 	W1 x4 

MRLZ01

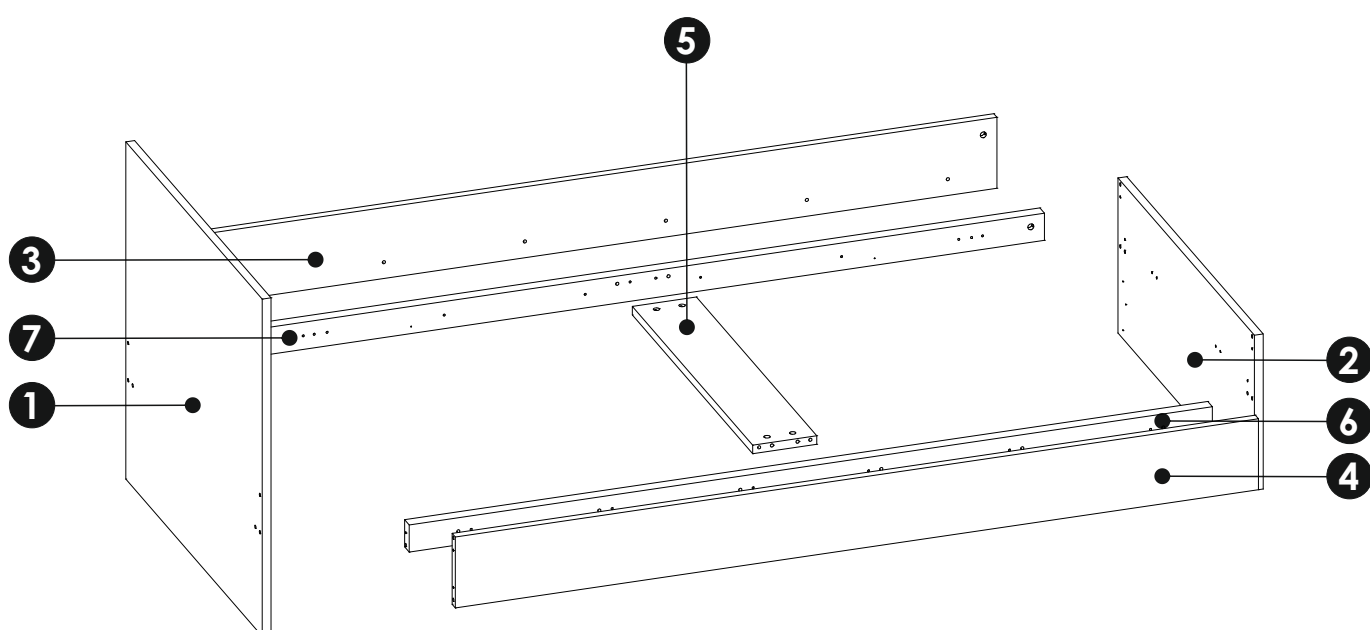
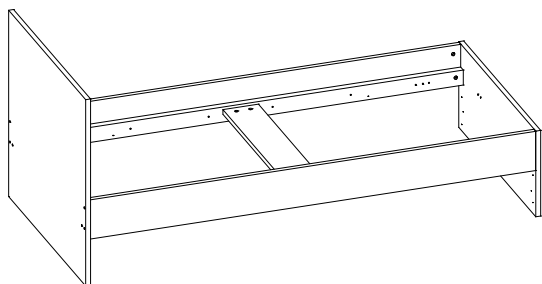

1	953	870	22	x1	1/2
2	953	400	22	x1	1/2
3	2005	183	22	x1	2/2
4	2005	183	22	x1	2/2
5	841	160	22	x1	1/2
6	2005	70	32	x1	2/2
7	2005	70	32	x1	2/2

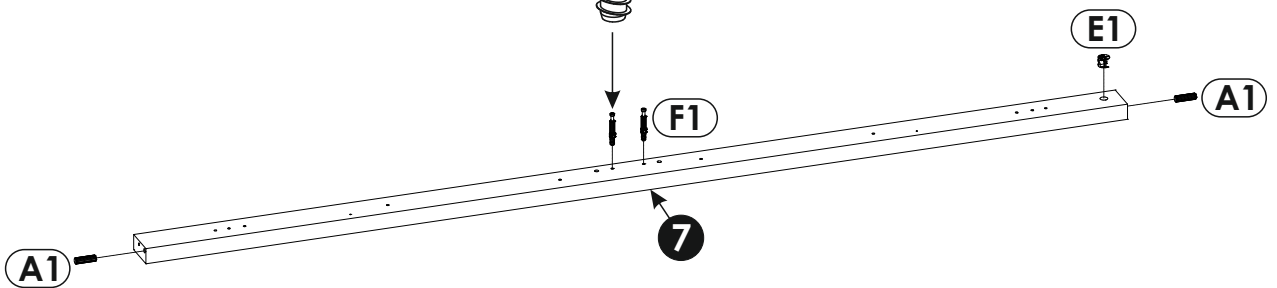
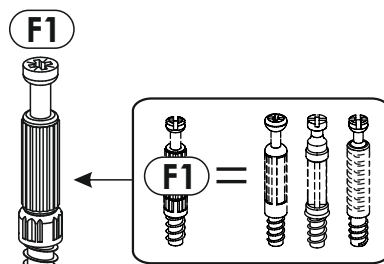
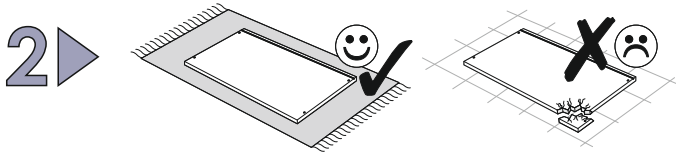
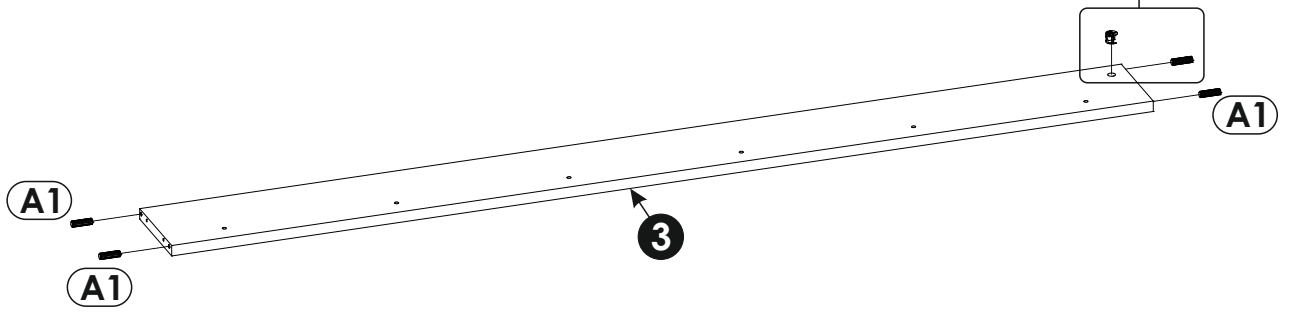
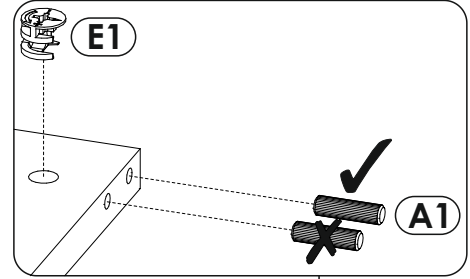
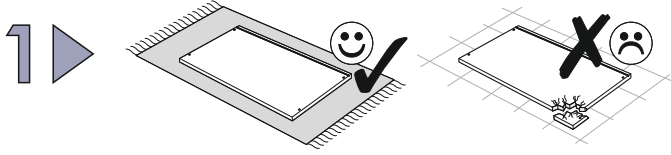
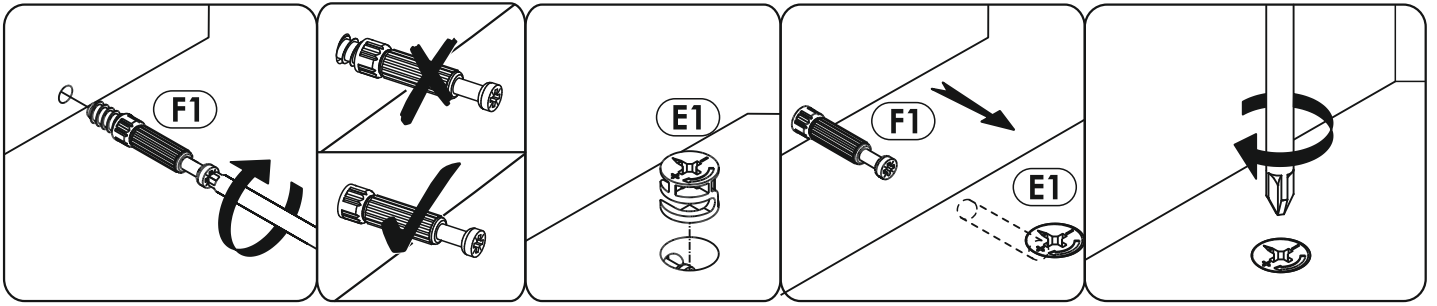

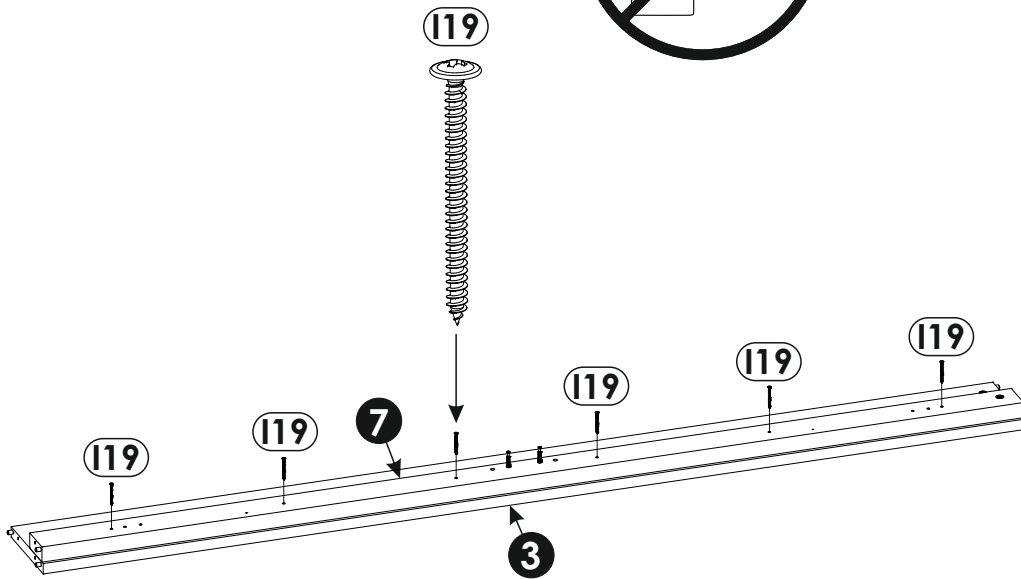
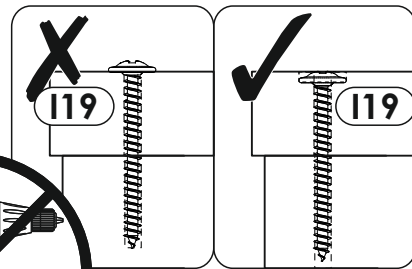
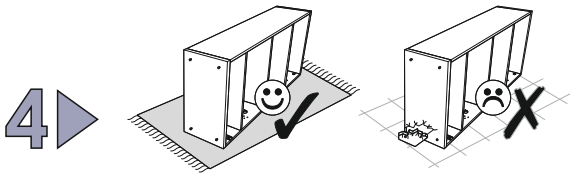
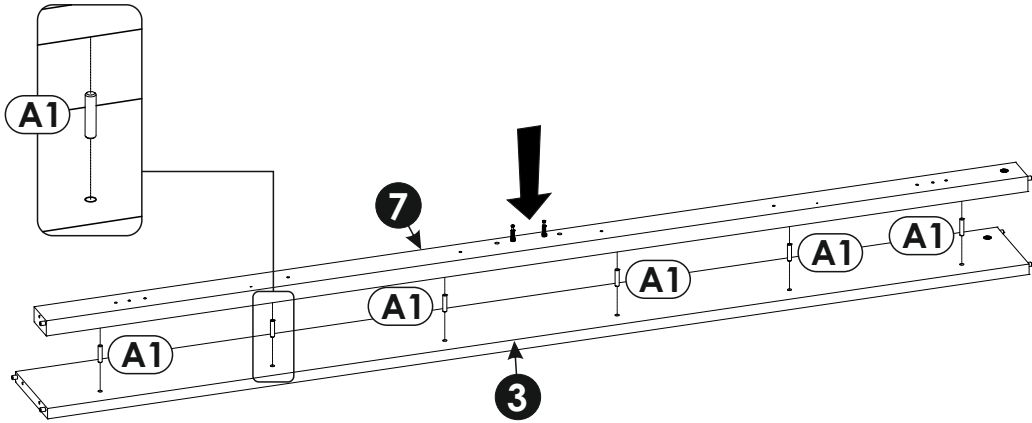
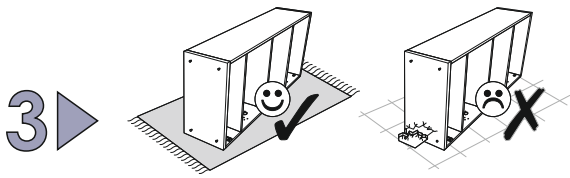

5 ▶

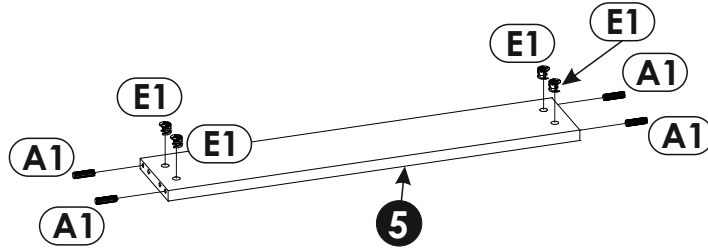
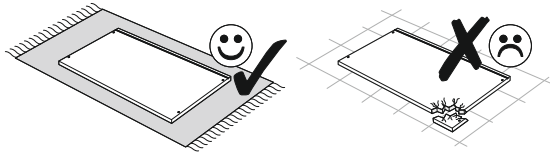

6 ▶

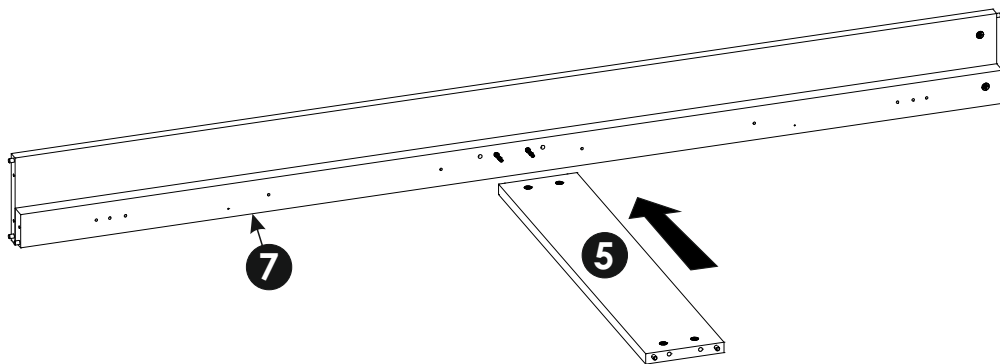
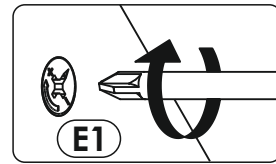
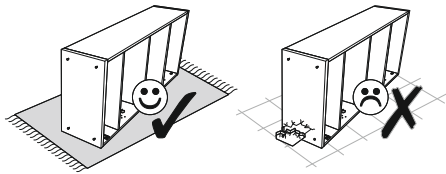

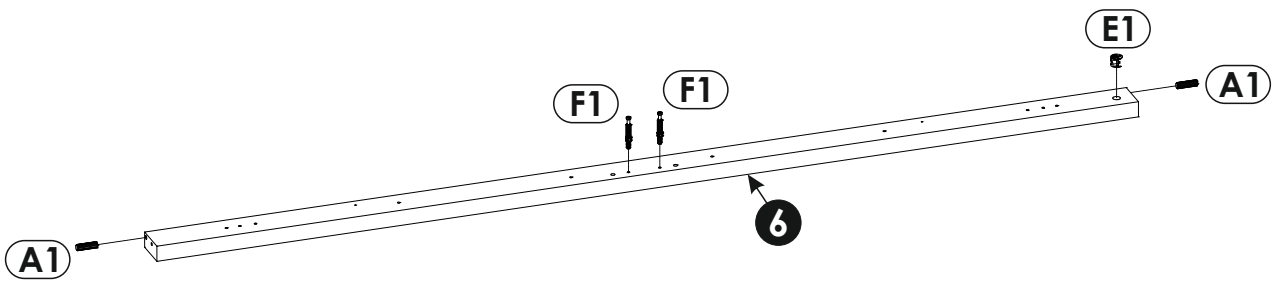
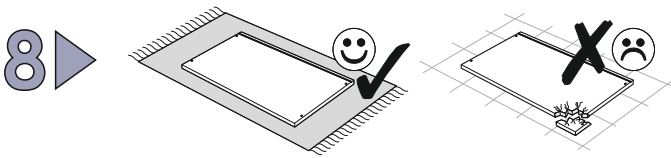
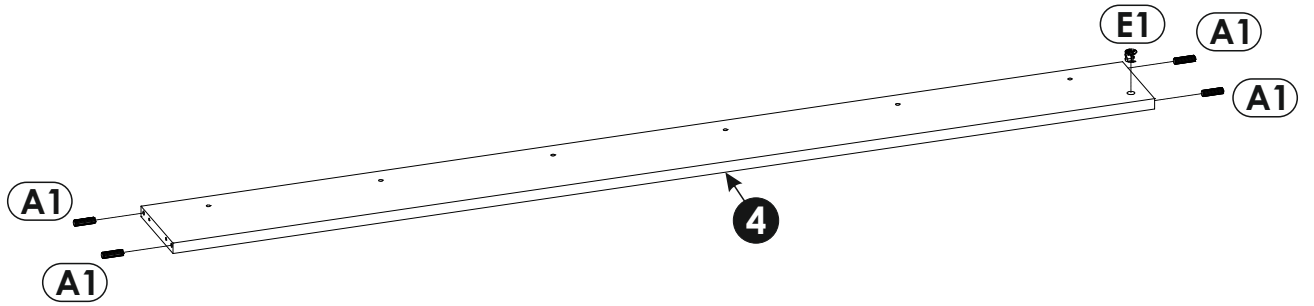
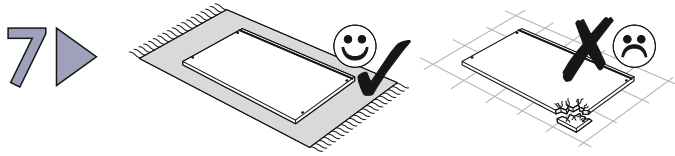

9 ▶

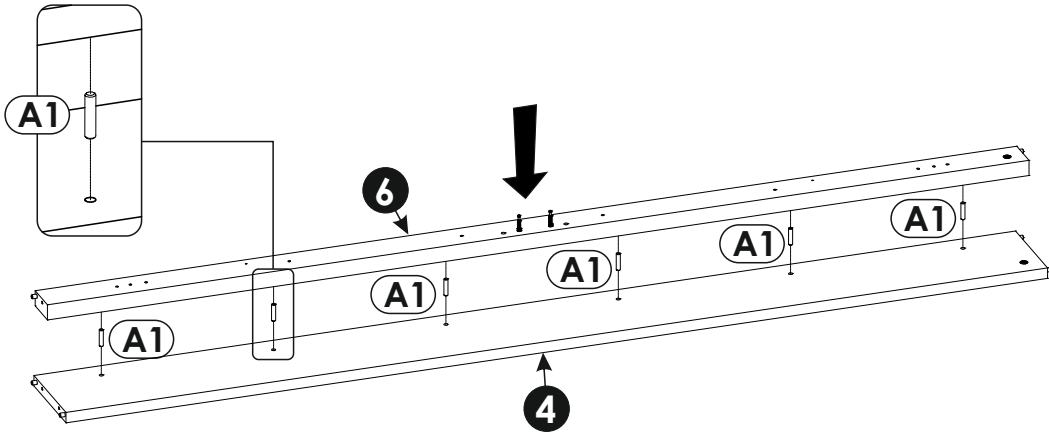
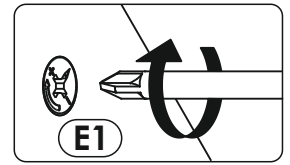
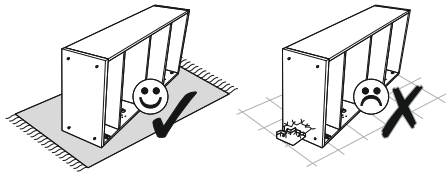

10 ▶

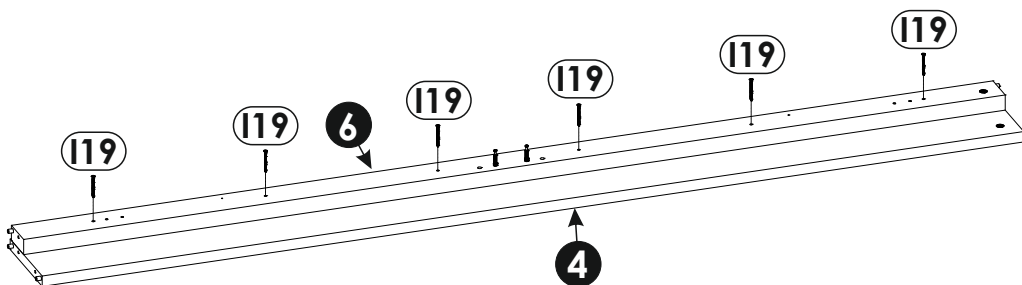
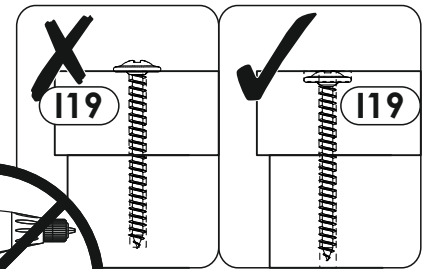
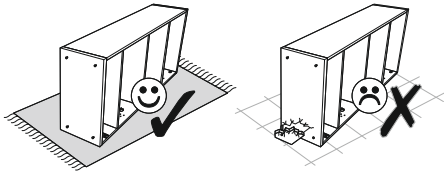

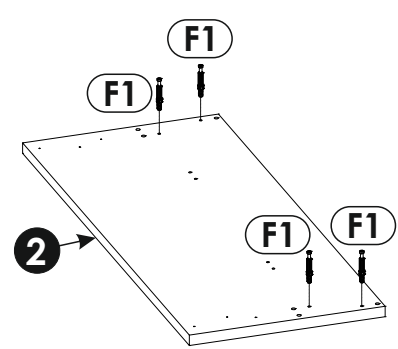
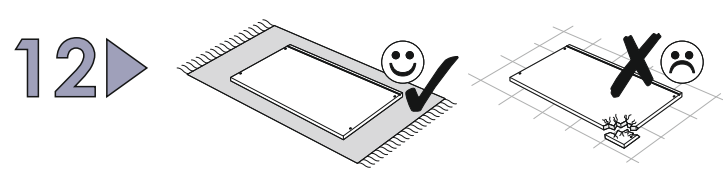
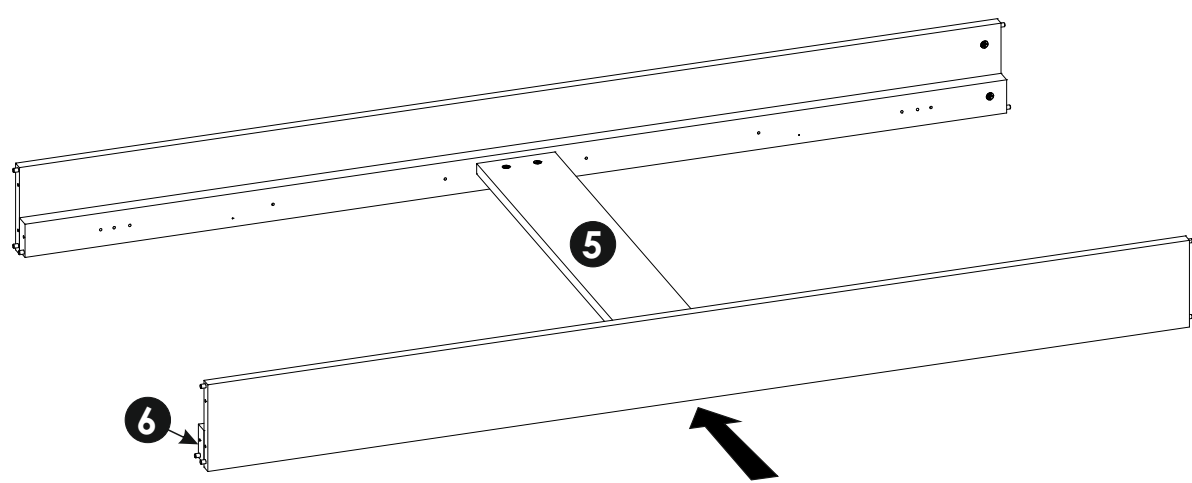
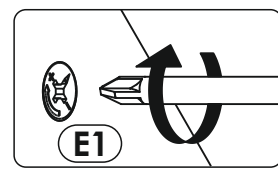
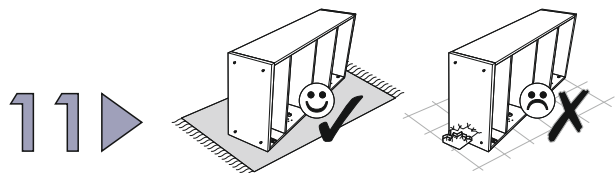

13 ▶

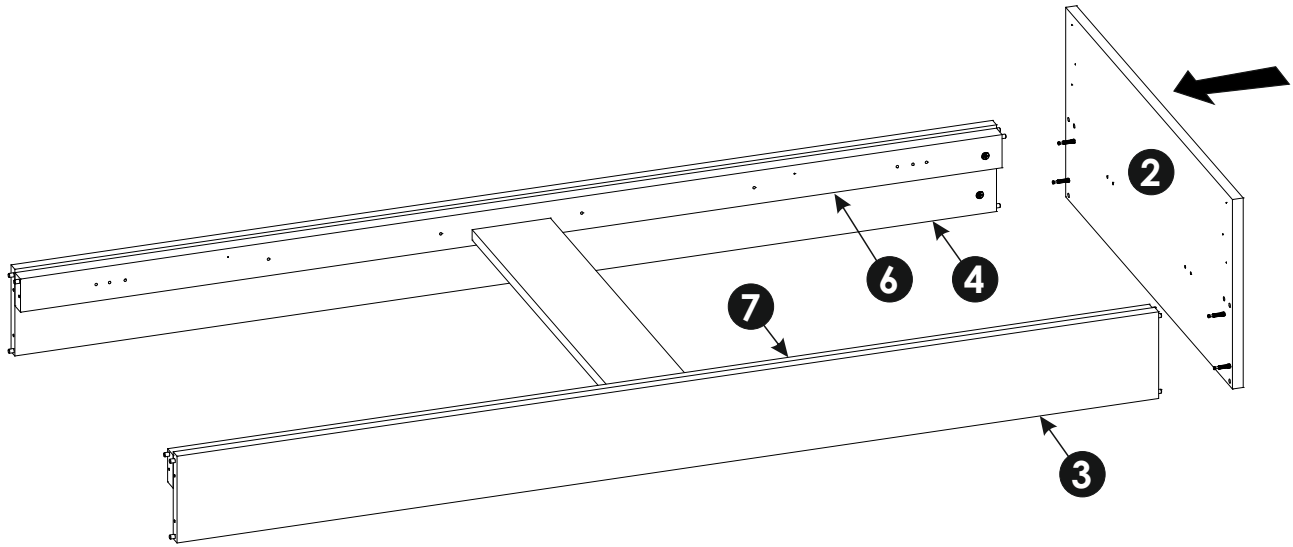
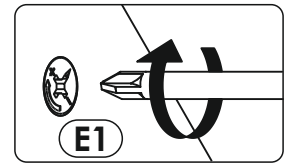
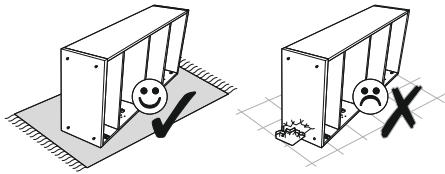

14 ▶

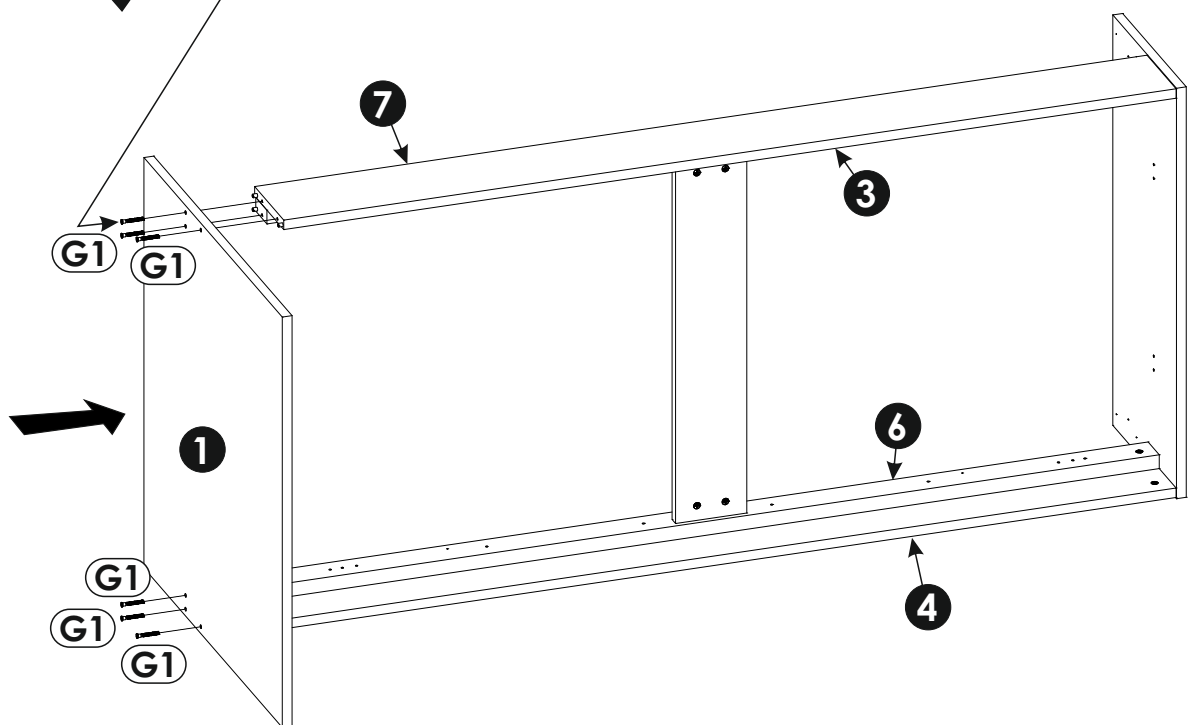
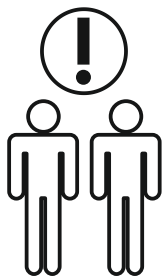
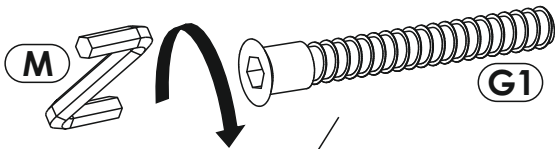
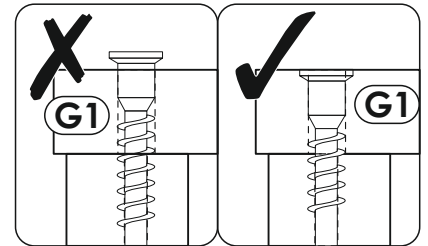
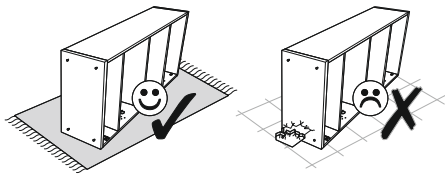

15 ▶

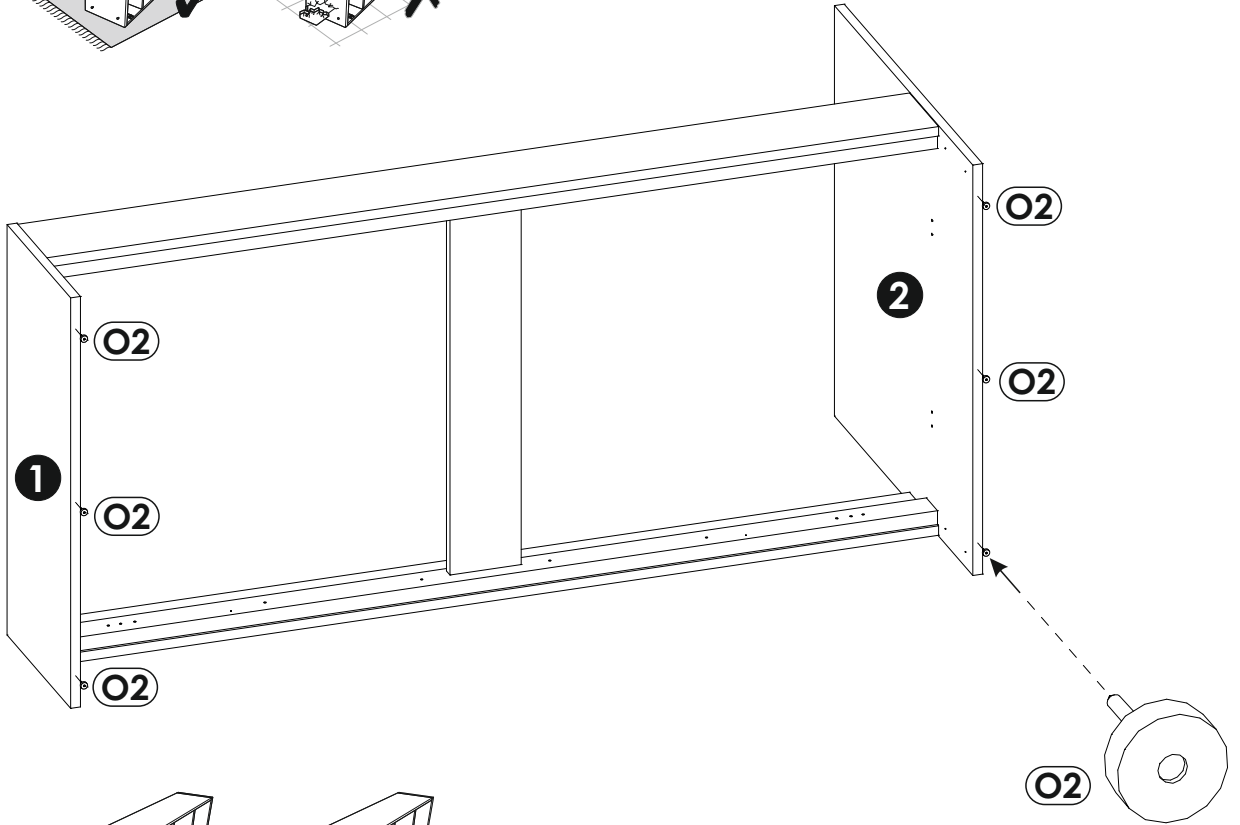
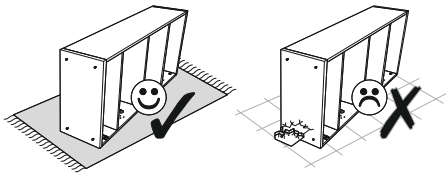

16 ▶

