

NÁVOD NA MONTÁŽ AK-304

30 min

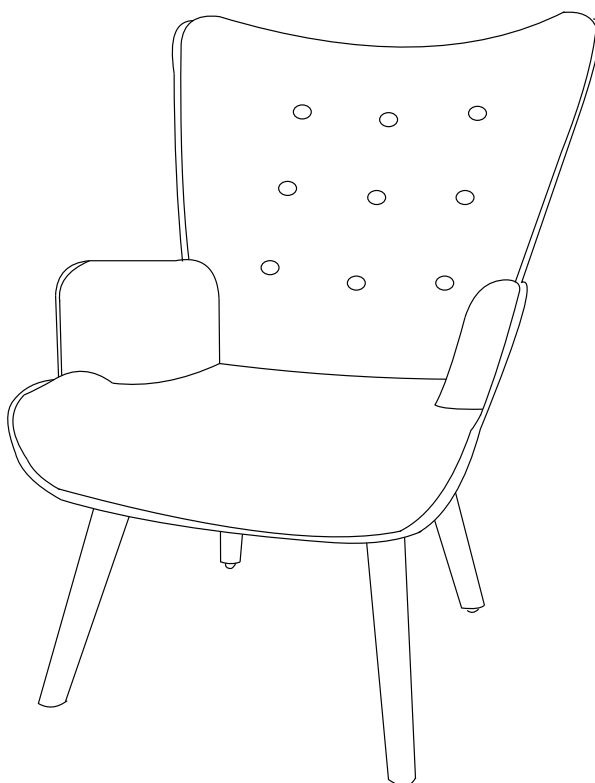

2 x



Cz MONTÁŽNÍ POKYNY

1. Pečlivě ověřte, zda díly před montáží nechybí nebo nejsou poškozené.
2. Při montáži dejte pozor na přítomnost dětí, aby nedošlo k vdechnutí, spolknutí malých dílů nebo poranění.
3. **Šrouby během instalace neutahujte. Po instalaci všech šroubů je rovnoměrně utáhněte.**

POKYNY K POUŽÍVÁNÍ

1. K čištění používejte pouze měkký hadřík a prostředky k tomu určené.
2. Nepoužívejte na místech s nadměrným výskytem vlhkosti nebo teploty.
3. Při používání křesla **nesedte** pouze v přední části nebo jen v jeho polovině a křeslo nepřetěžujte.
4. Nesedějte na křeslo v opačném směru, ani na něj **nestoupejte**.
5. Nepoužívejte křeslo k jinému účelu, než je určeno.

Sk MONTÁŽNE POKYNY

1. Starostlivo overte, či diely pred montážou nechybajú alebo nie sú poškodené.
2. Pri montáži dajte pozor na prítomnosť detí, aby nedošlo k vdýchnutiu, prehltnutiu malých dielov alebo poraneniu.
3. **Skrutky počas inštalácie neťahajte. Po inštalácii všetkých skrutiek ich rovnomerne utiahnite.**

POKYNY NA POUŽÍVANIE

1. Na čistenie používajte iba mäkkú handričku a prostriedky na to určené.
2. Nepoužívajte na miestach s nadmerným výskytem vlhkosti alebo teploty.
3. Pri používaní kresla **nesedte** iba v prednej časti alebo len v jeho polovici a kreslo nepreťažujte.
4. Nesadajte na kreslo v opačnom smere, ani na nej **nestúpajte**.
5. Nepoužívajte kreslo na iný účel, než je určené.

A x 1

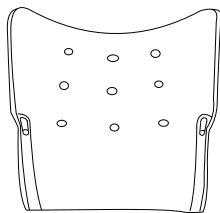

B x 1

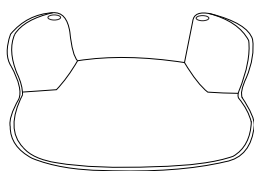

C x 2

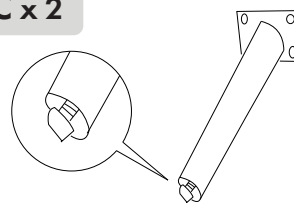

ZADNÍ / ZADNÉ NOHY

D x 2

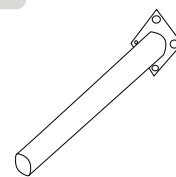

E x 2

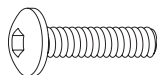

F x 2



I x 2



G x 16

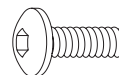

H x 1

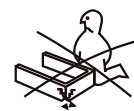
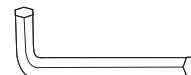

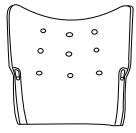
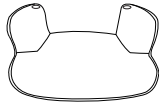
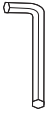
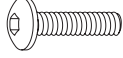
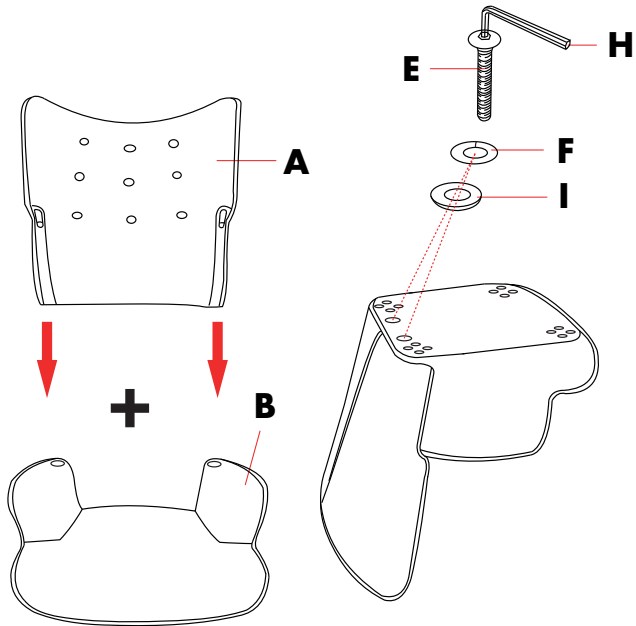
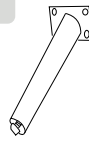
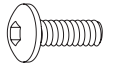
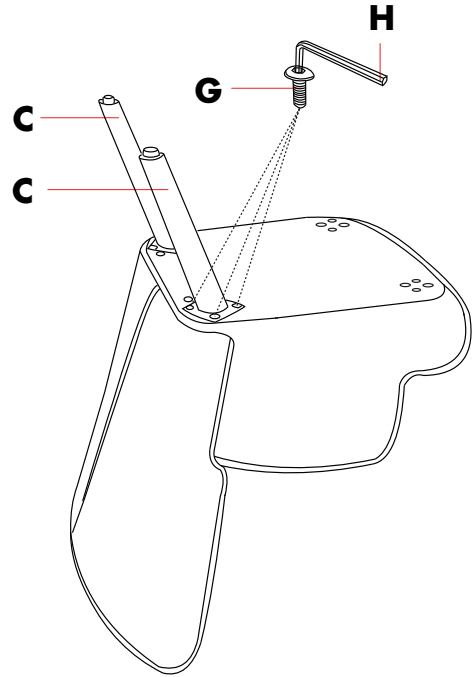
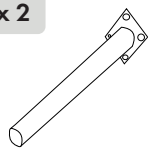
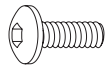
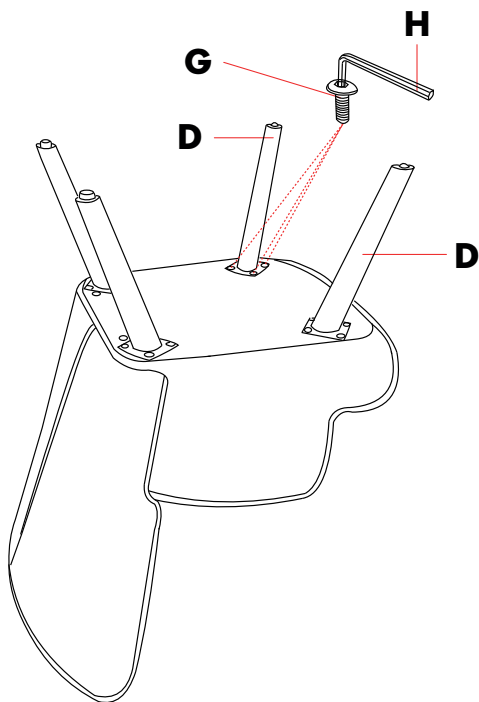
1**A x 1****B x 1****H****E x 2****F x 2****I x 2****2****C x 2****G x 8****H****3****D x 2****G x 8****H****4**