

# VERTI 2 TYP 70

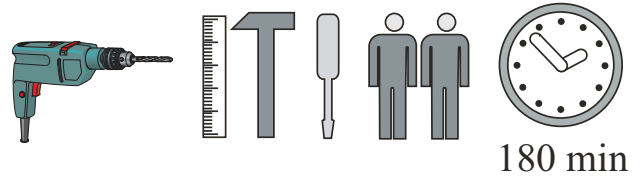

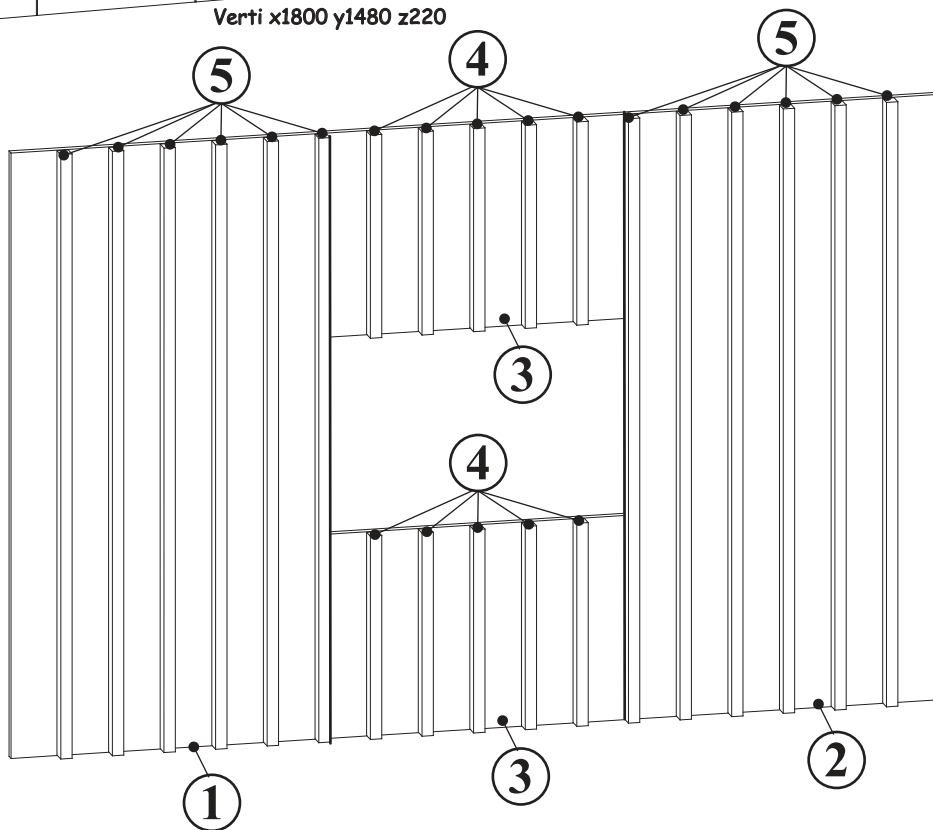

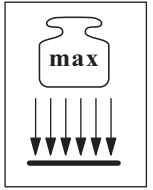
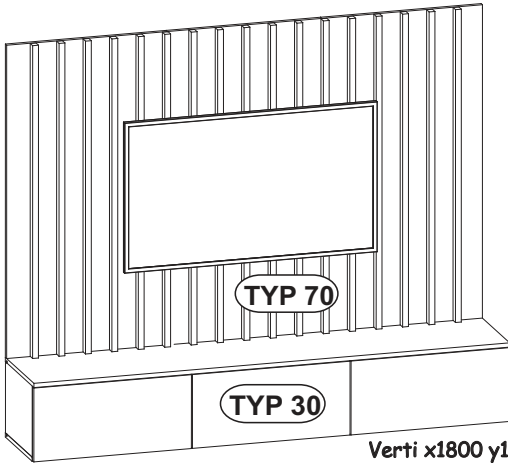
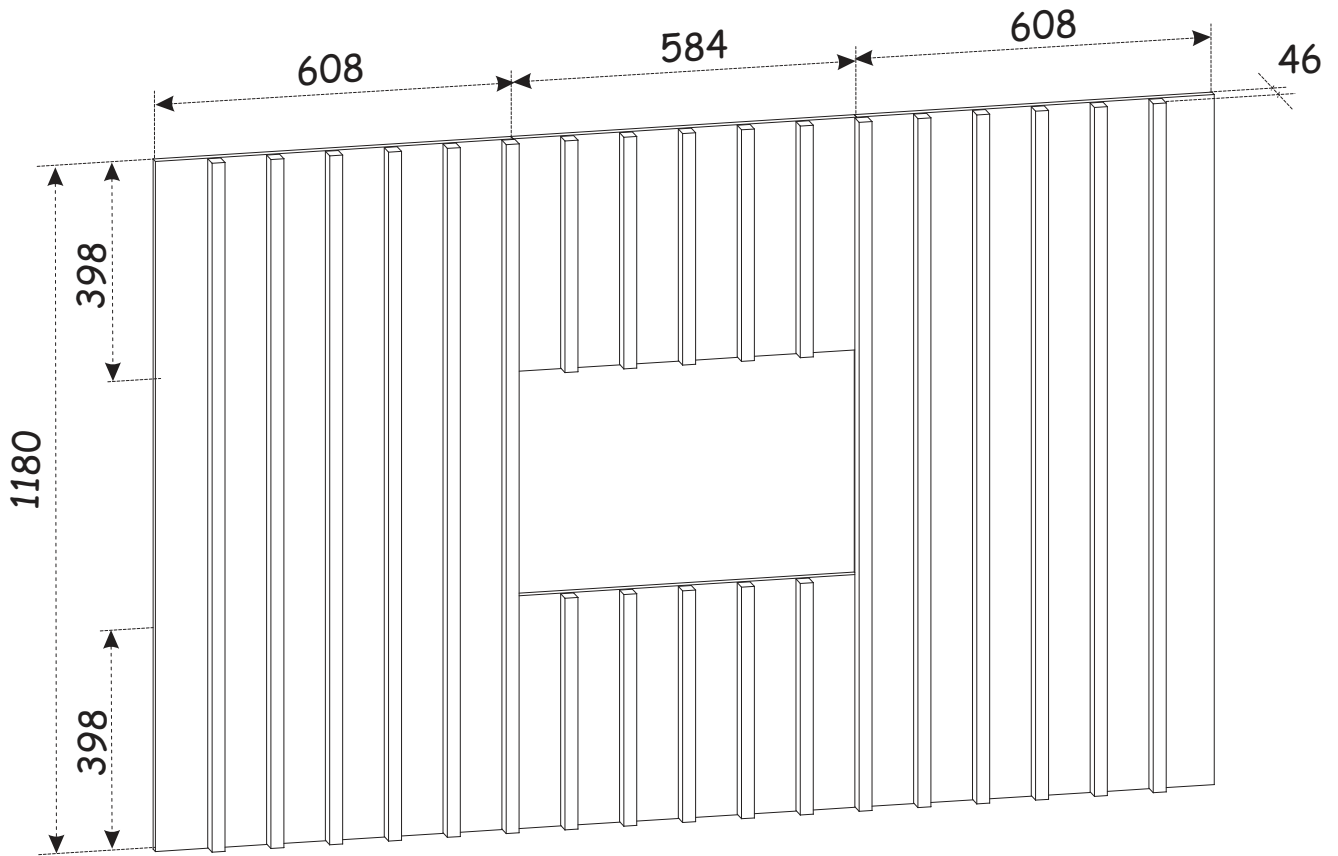

NO	DIM [mm]		COL.-NO	QTY
1	1180	608	16 2/3	1
2	1180	608	16 2/3	1
3	398	584	16 3/3	2
4	396	30	22 3/3	10
5	1178	30	22 2/3	12

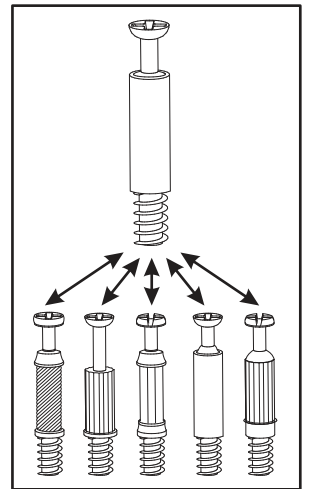
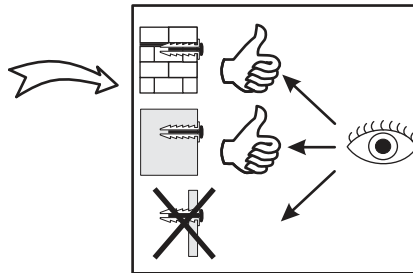
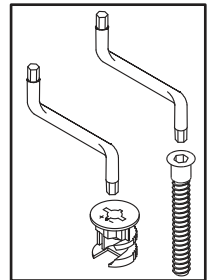
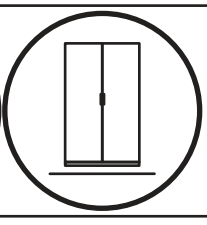
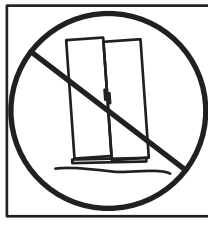
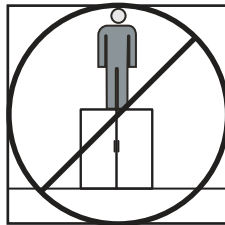
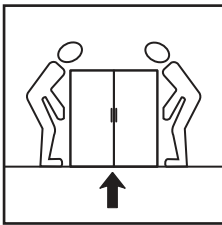
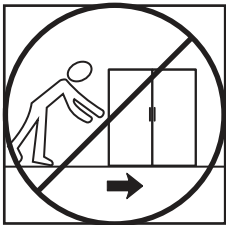
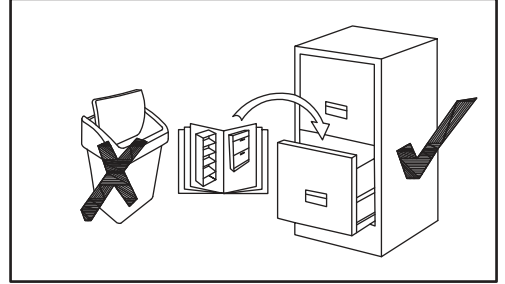
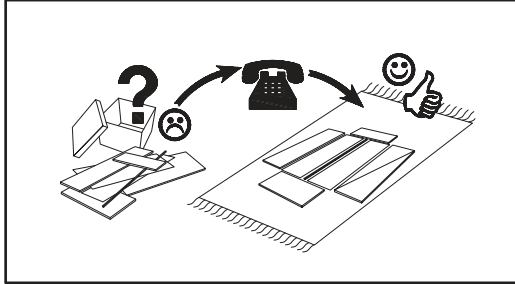
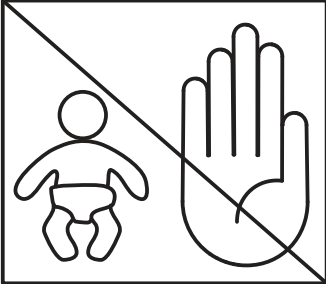
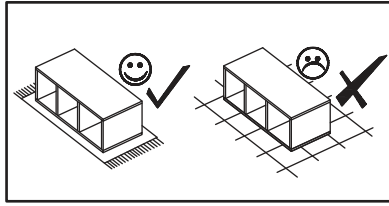
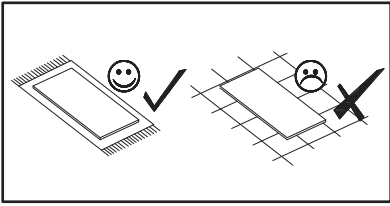
# VERTI 2 TYP 70



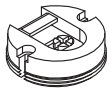
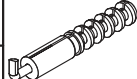
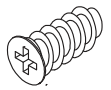

VERTI 2 TYP 70

B22		G4		ZM1		KR3		D20		G2	
X56	Ø7x40	X56		X8		X8	Ø10	X16	ESØ6,3x9,5	x1	

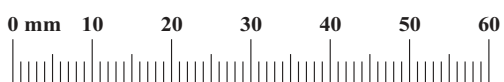

VERTI 2 TYP 70

1

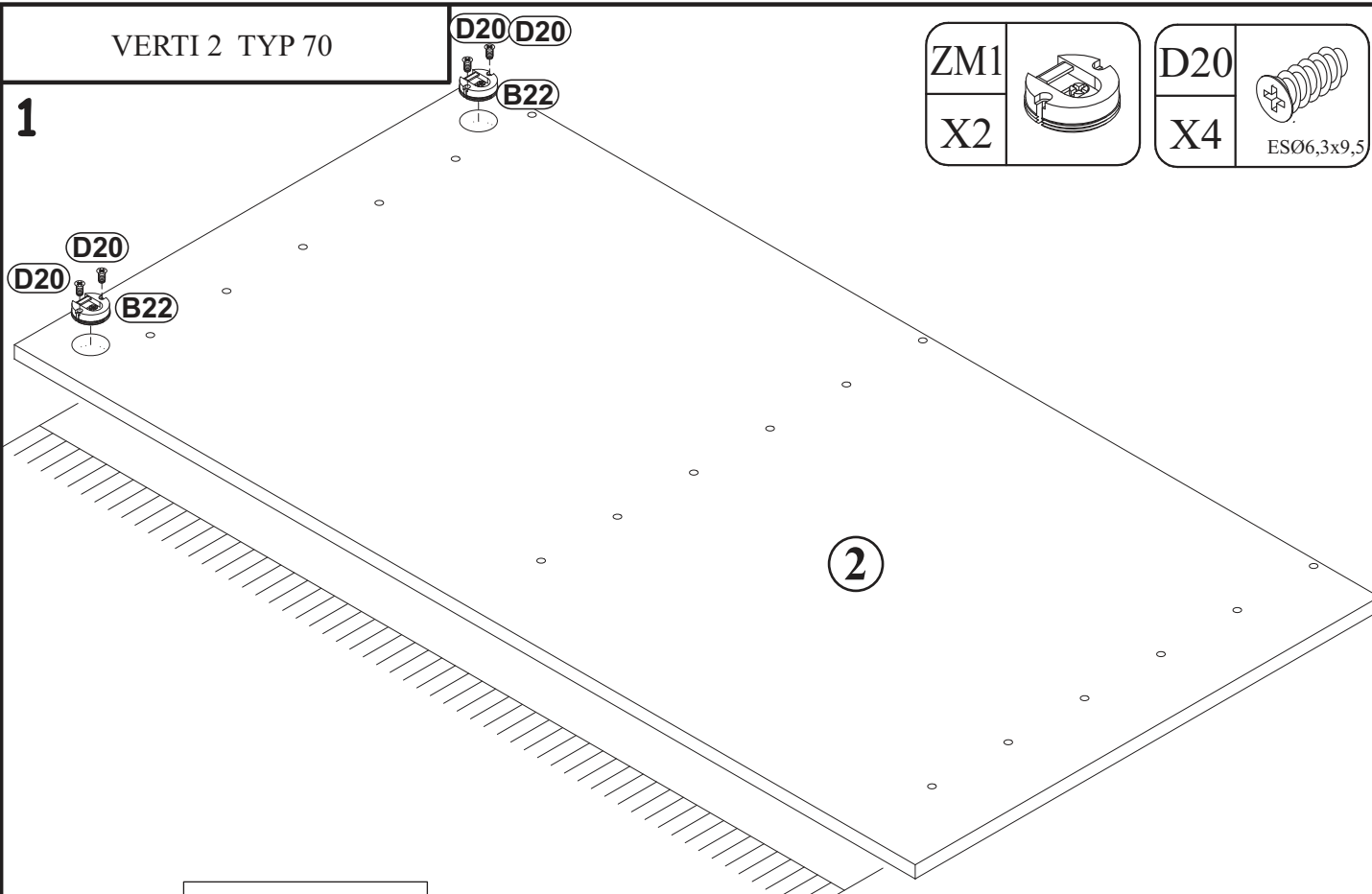

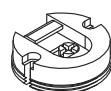
ZM1	
X2	

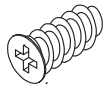
D20	
X4	ESØ6,3x9,5

2

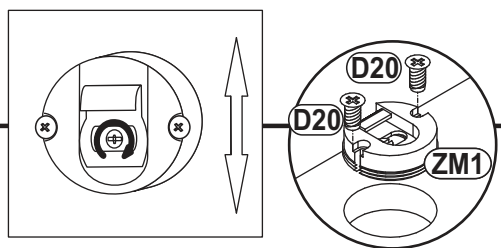

ZM1	
X4	

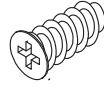
D20	
X8	ESØ6,3x9,5

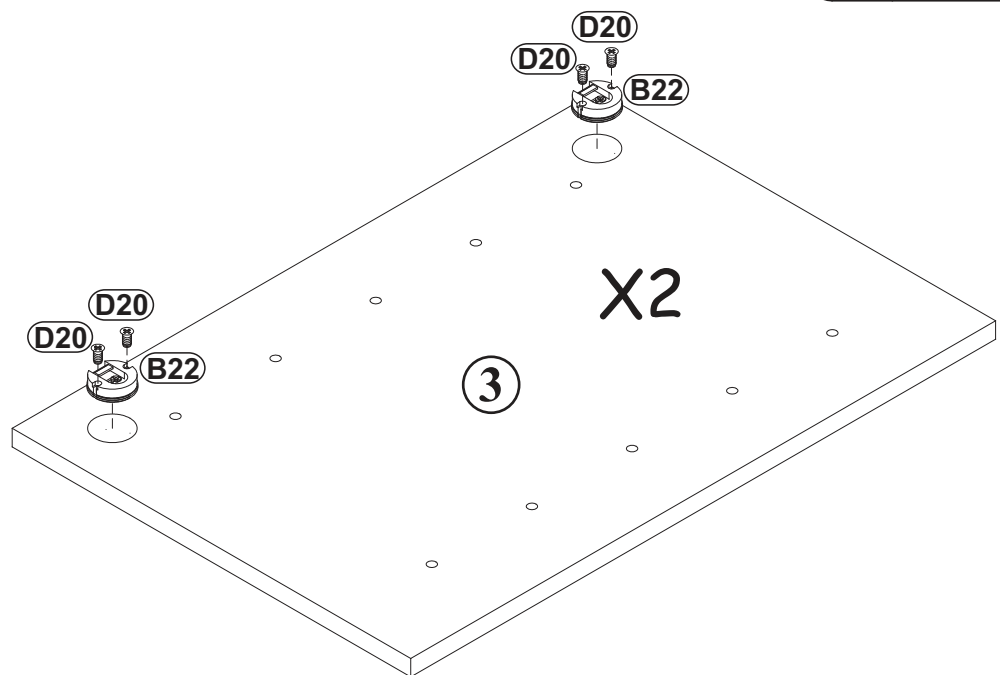

VERTI 2 TYP 70

3

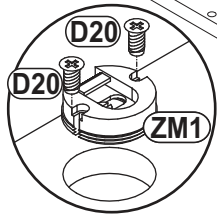
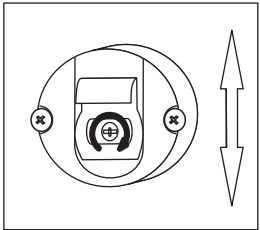
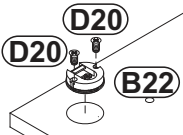
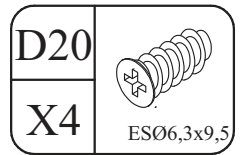
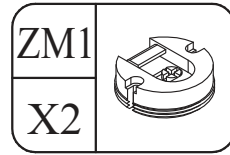
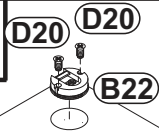

1

4

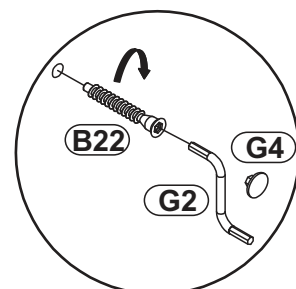
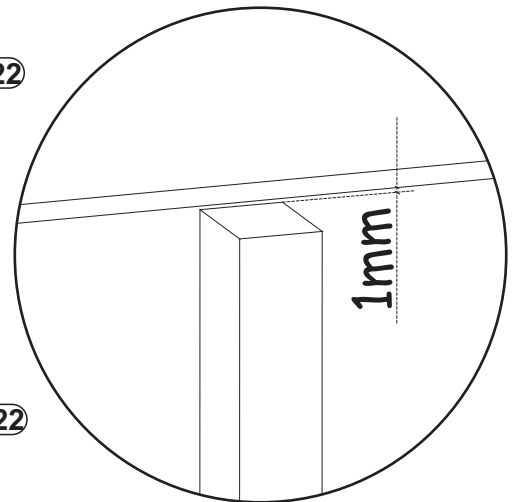
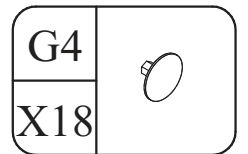
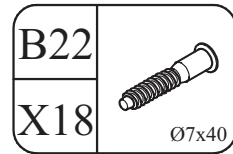
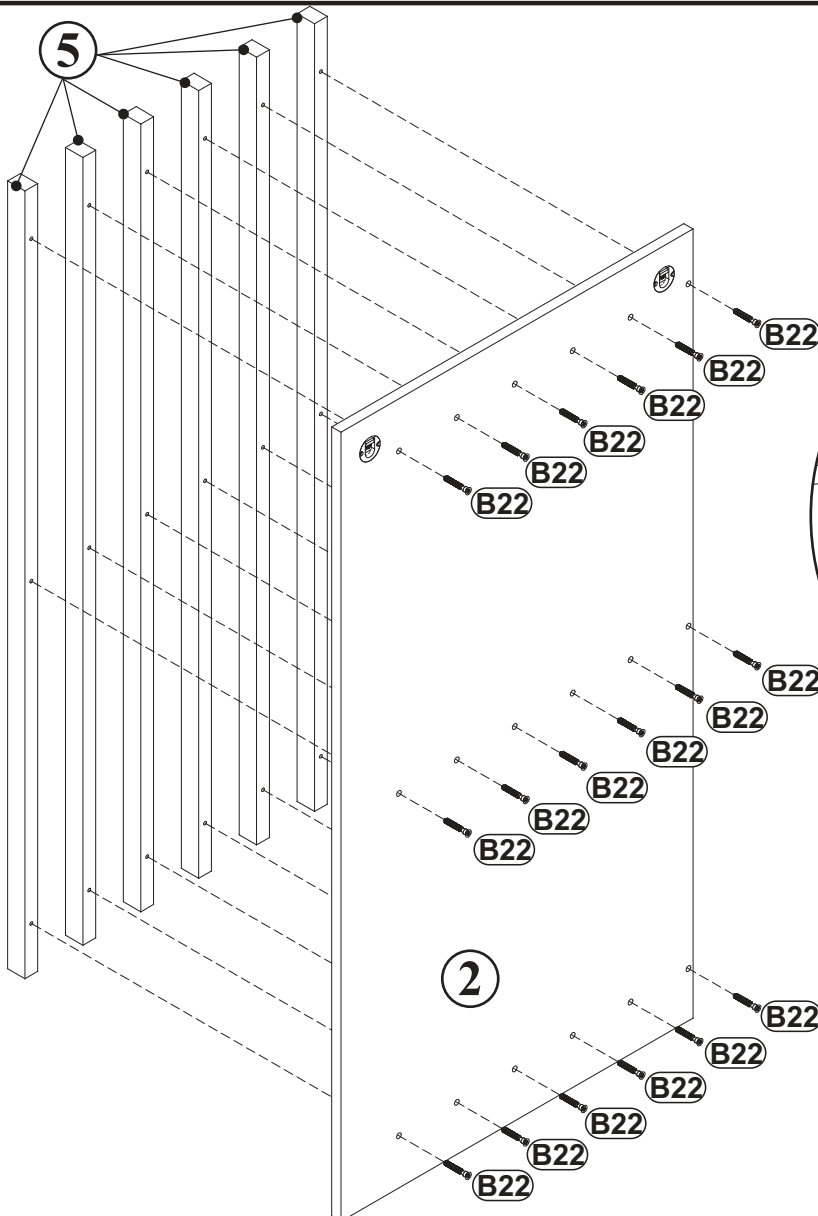



2

VERTI 2 TYP 70

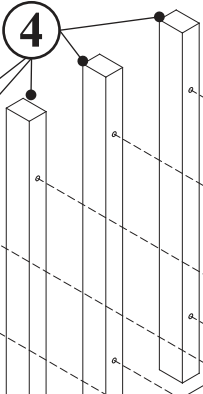
5



B22	 Ø7x40
X20	

G4	
X20	

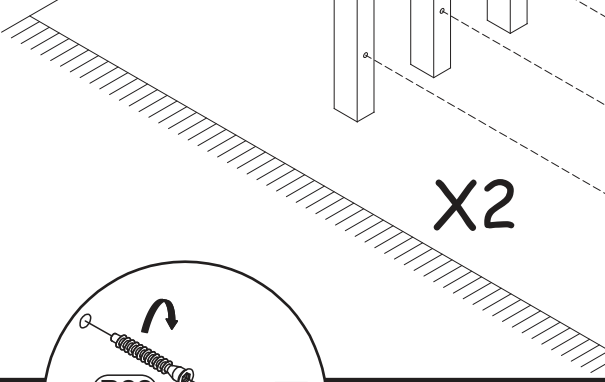

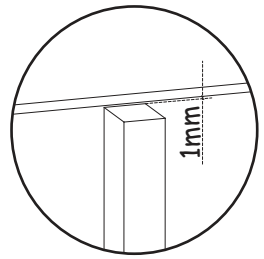

3

X2

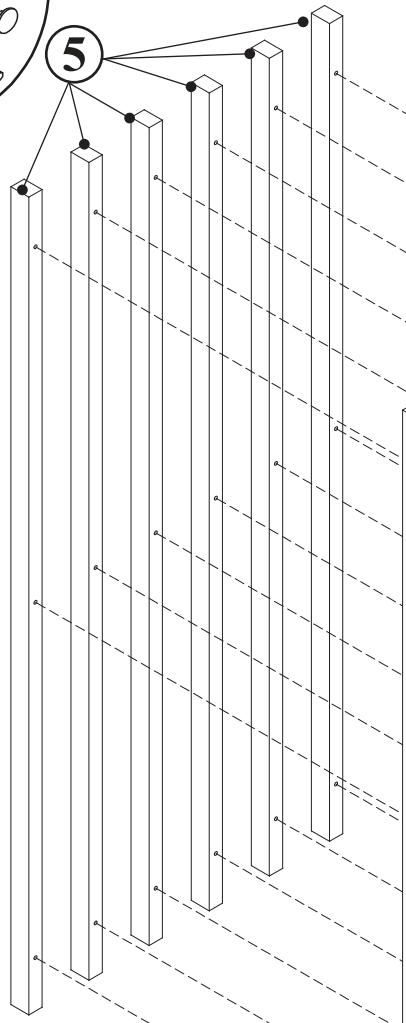
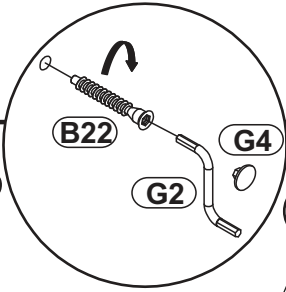

6



B22	 Ø7x40
X18	

G4	
X18	

1

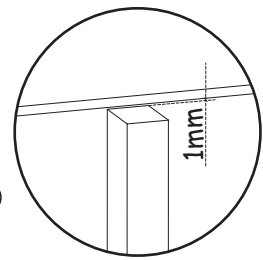

7

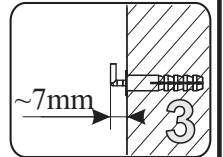
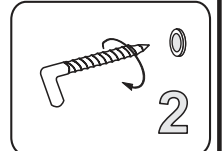
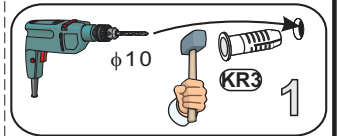
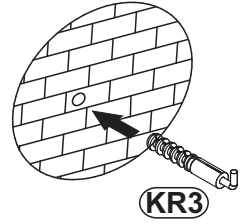
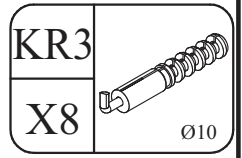
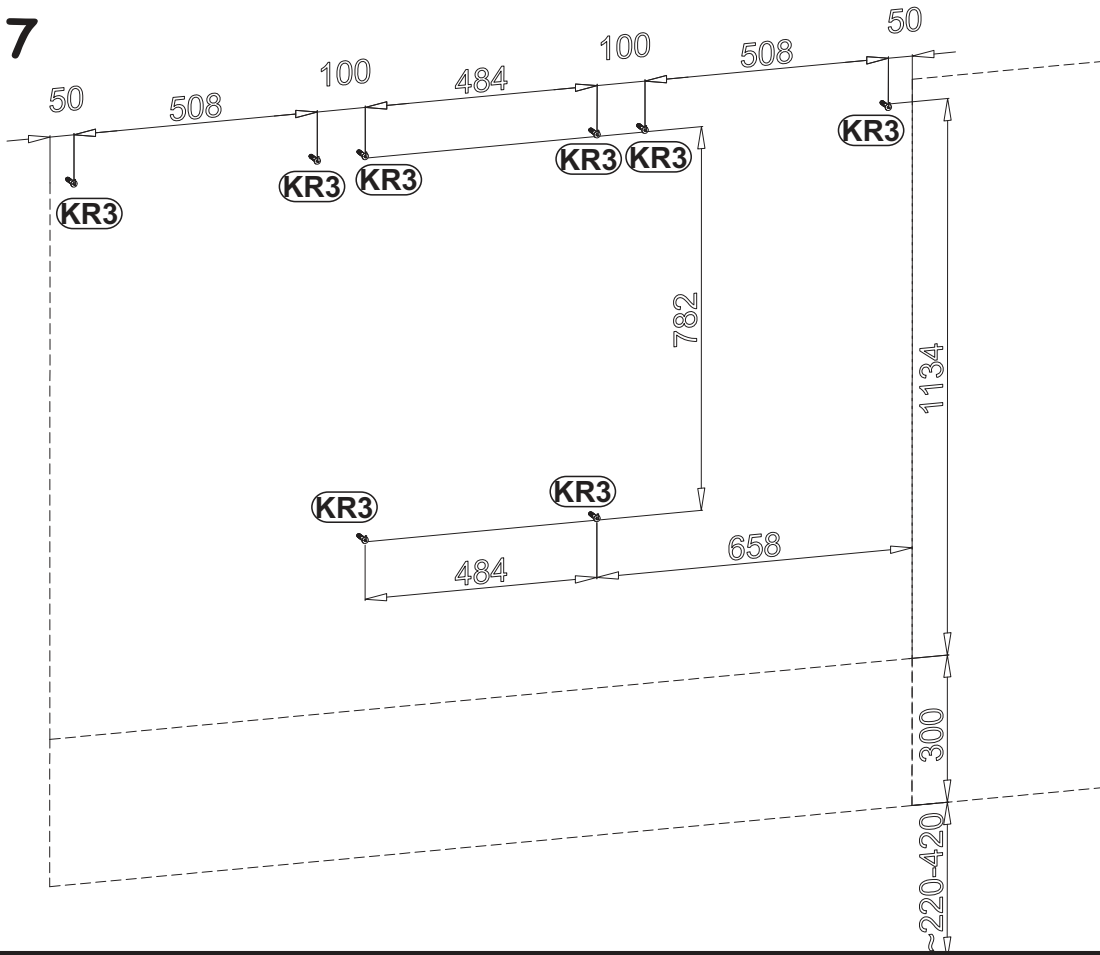

8

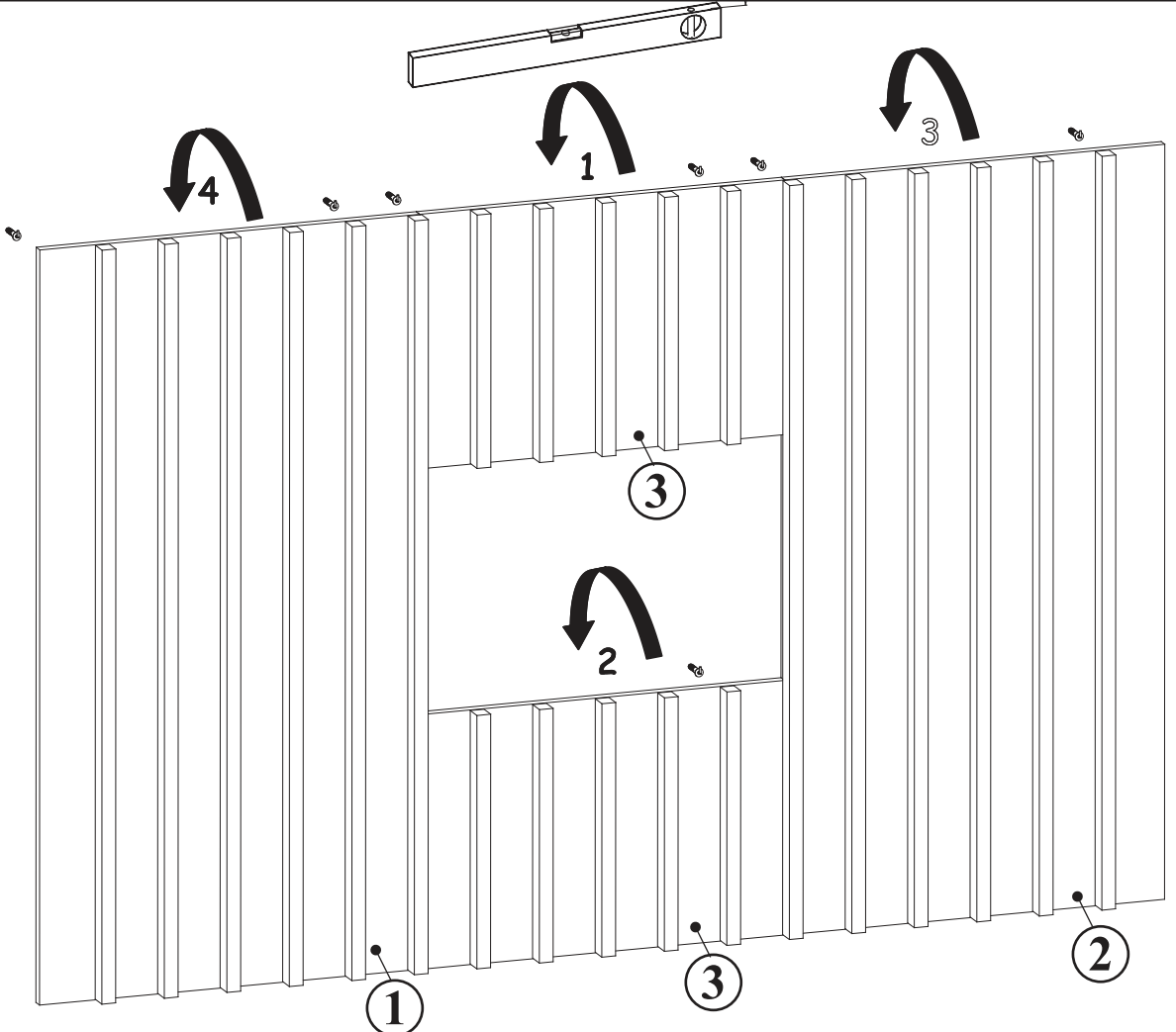



# VERTI 2 TYP 30

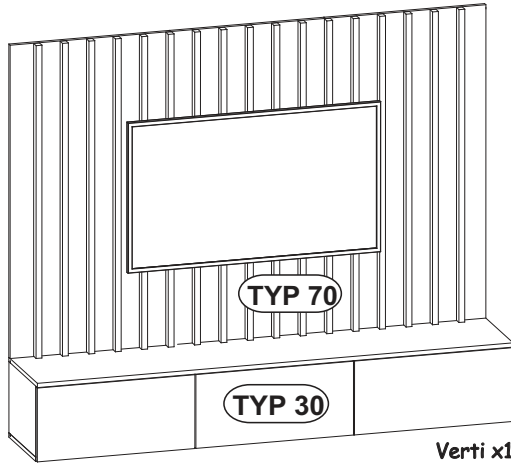

Verti x1800 y1480 z220

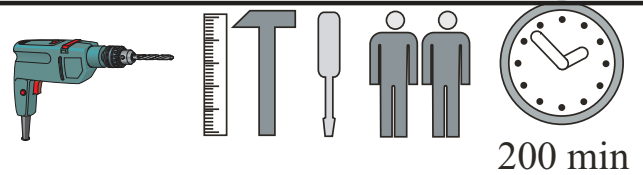
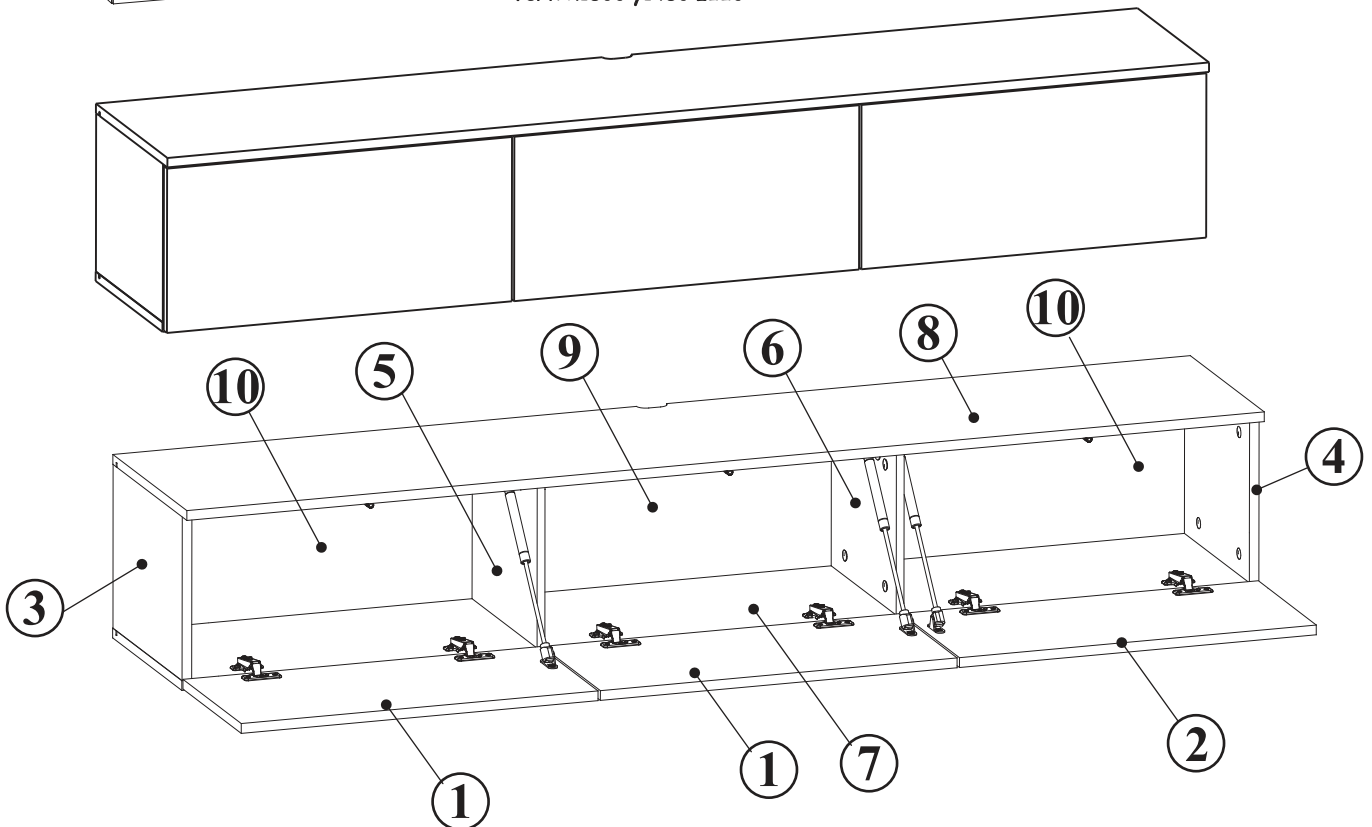

NO	DIM [mm]		COL.-NO	QTY
1	596	278	16 1/3	2
2	596	278	16 1/3	1
3	268	330	16 1/3	1
4	268	330	16 1/3	1
5	268	310	16 1/3	1
6	268	310	16 1/3	1
7	1800	330	16 1/3	1
8	1800	353	16 1/3	1
9	280	600	3 1/3	1
10	280	589	3 1/3	2

# VERTI 2 TYP 30

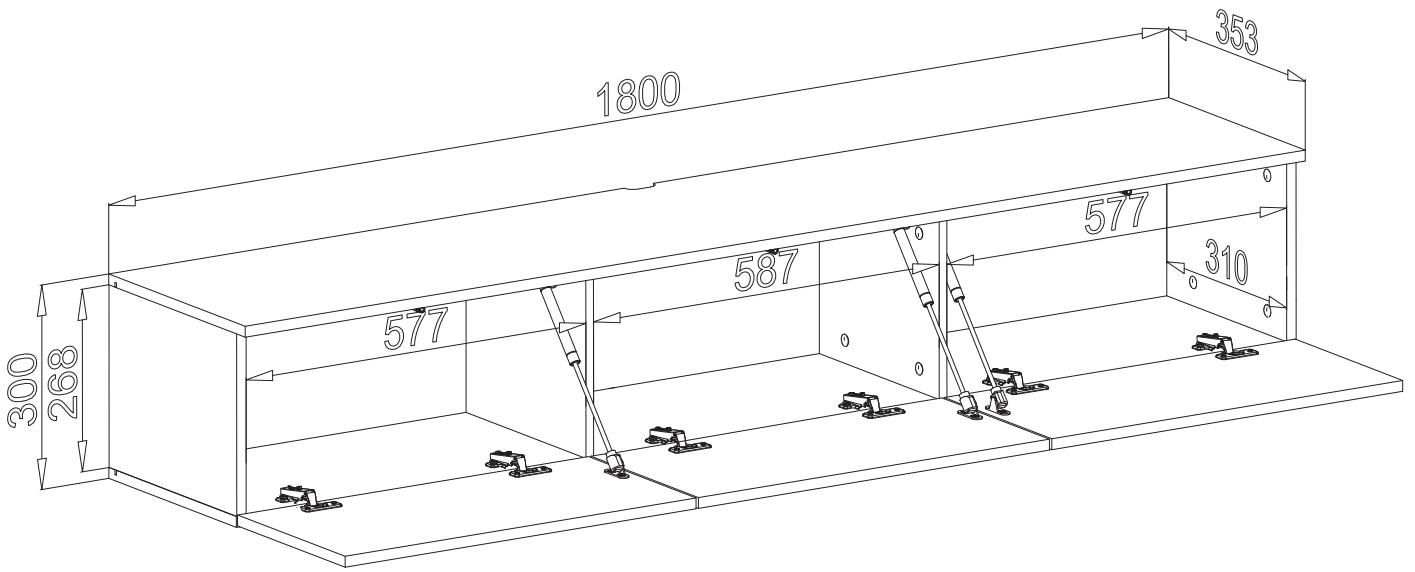

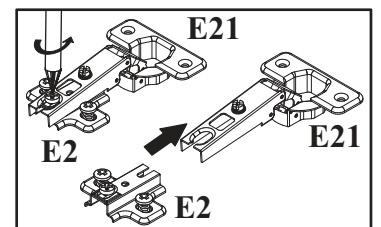
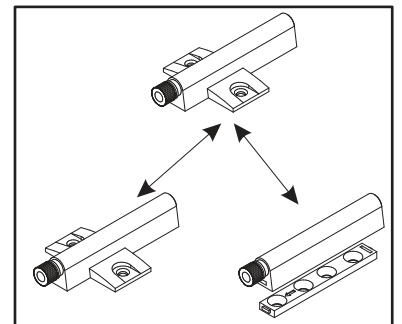
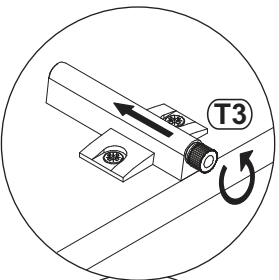
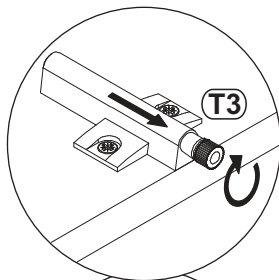
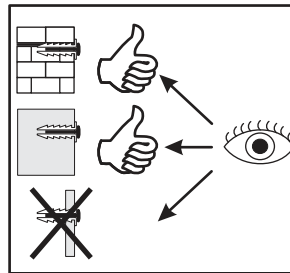
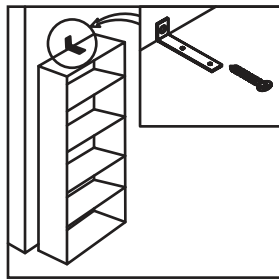
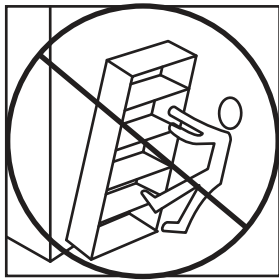
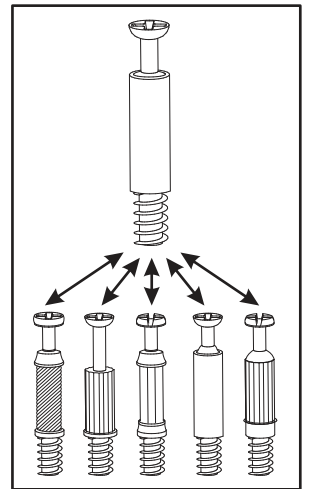
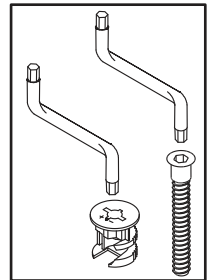
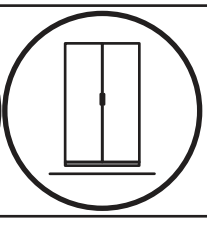
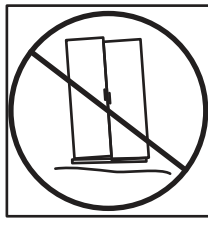
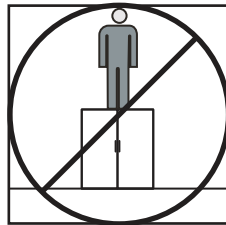
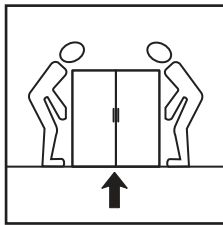
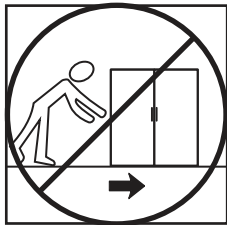
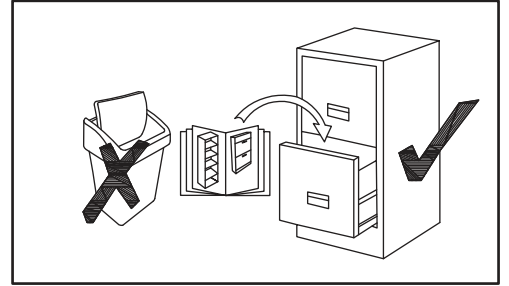
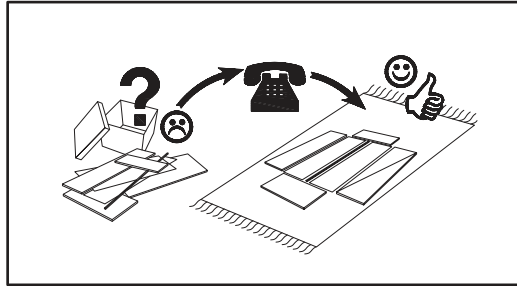
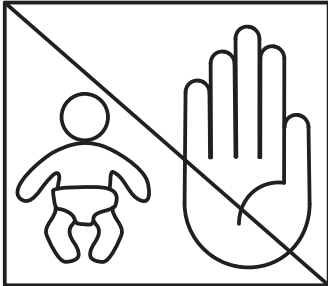
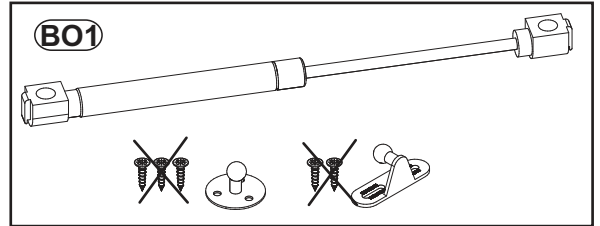
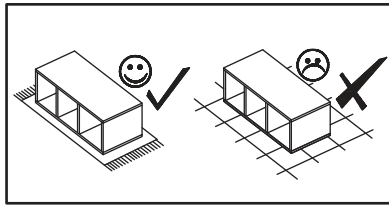
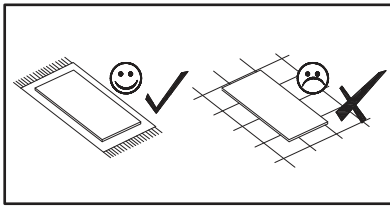

VERTI 2 TYP 30

A1 X16 Ø8x36	B4 X16	B5 X16 Ø15x12	G5 X16	E21 X6 Ø35 H=0	E2 X6 H=0
BO1 X3 OLEJOWY	G16 X4	ZXL X2	ZXP X2	SZ7 X4	KR1 X8 Ø8
S1 X14	D6 X8 USØ3,5x30	D10 X33 USØ3,5x13	UP13 X4 UPØ3x16	T3/T5 x3	G2 x1

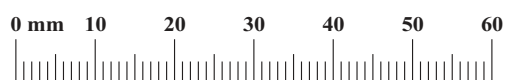
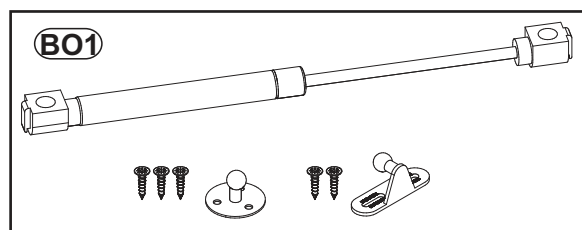
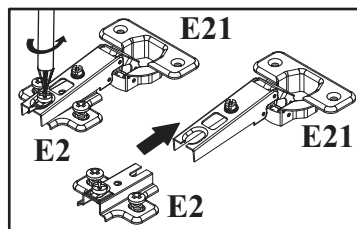

VERTI 2 TYP 30

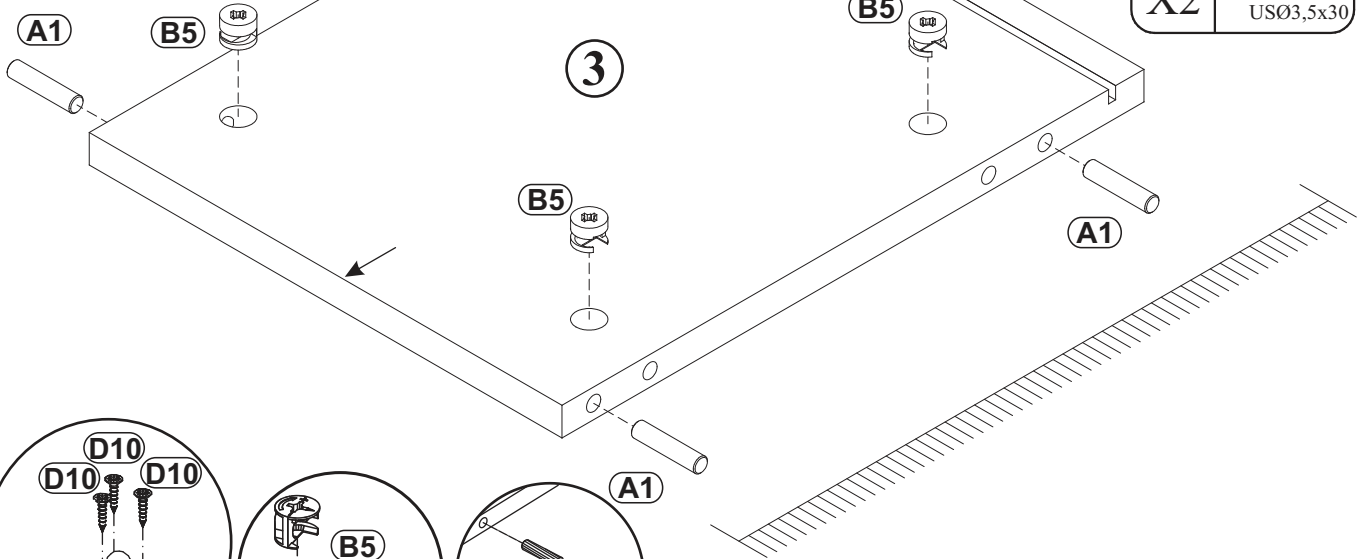
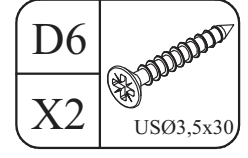
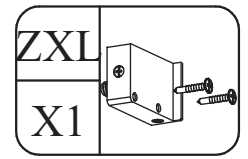
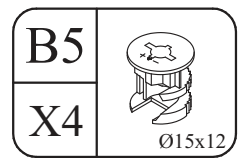
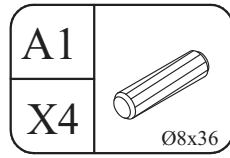
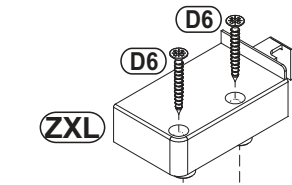
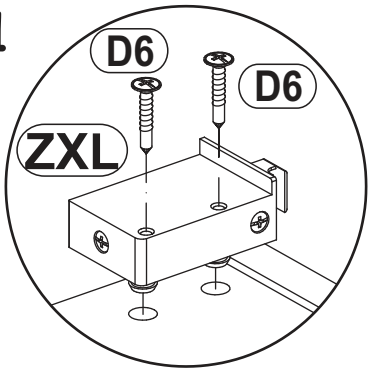

1

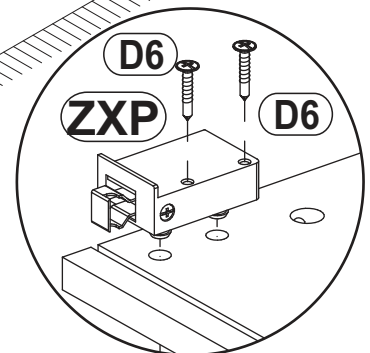
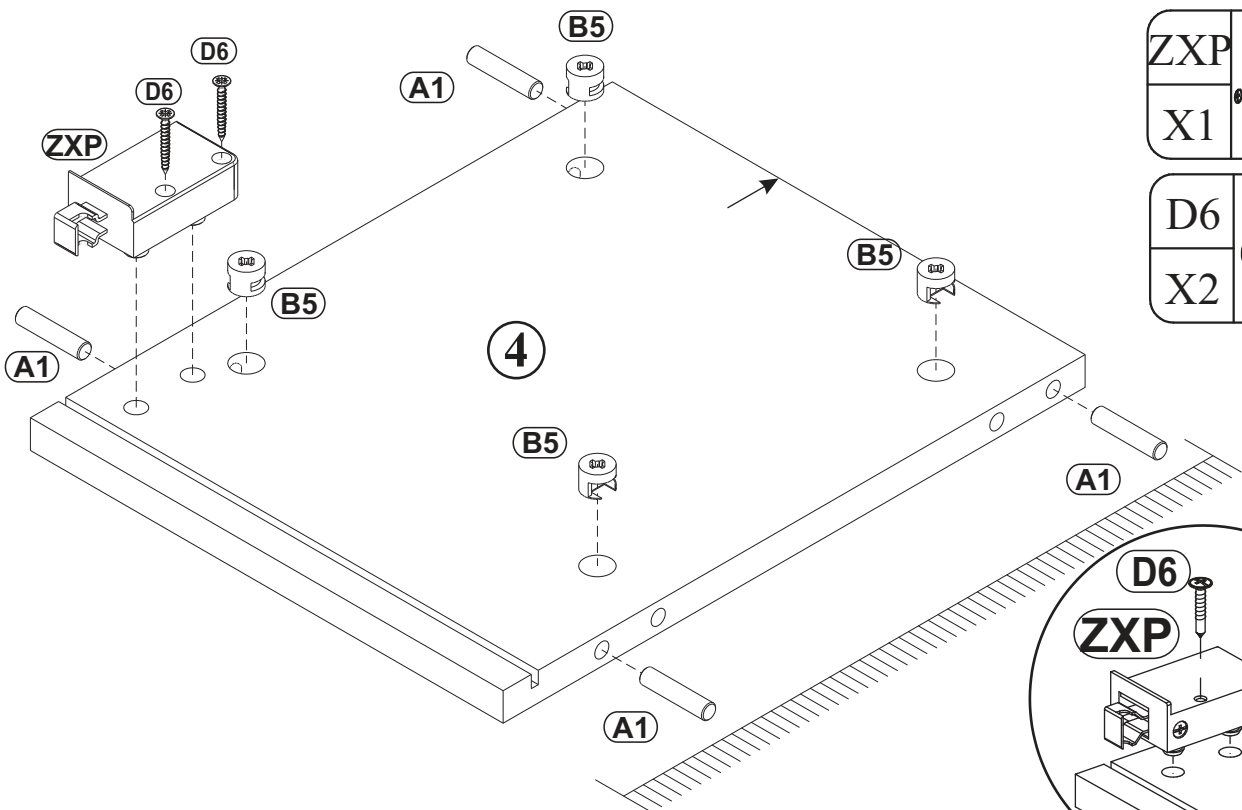
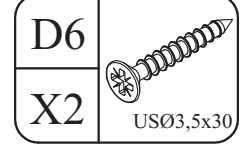
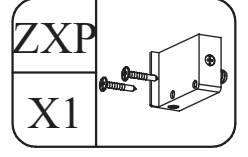
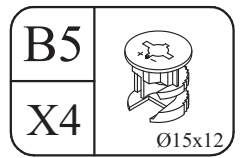
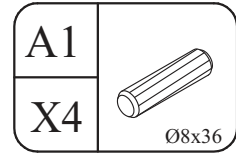
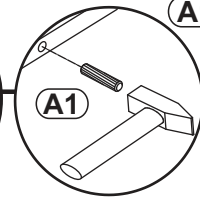
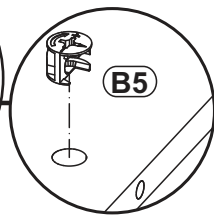
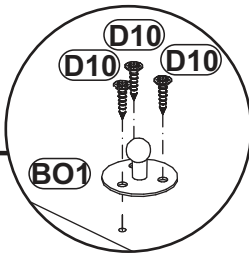

2



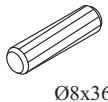

3

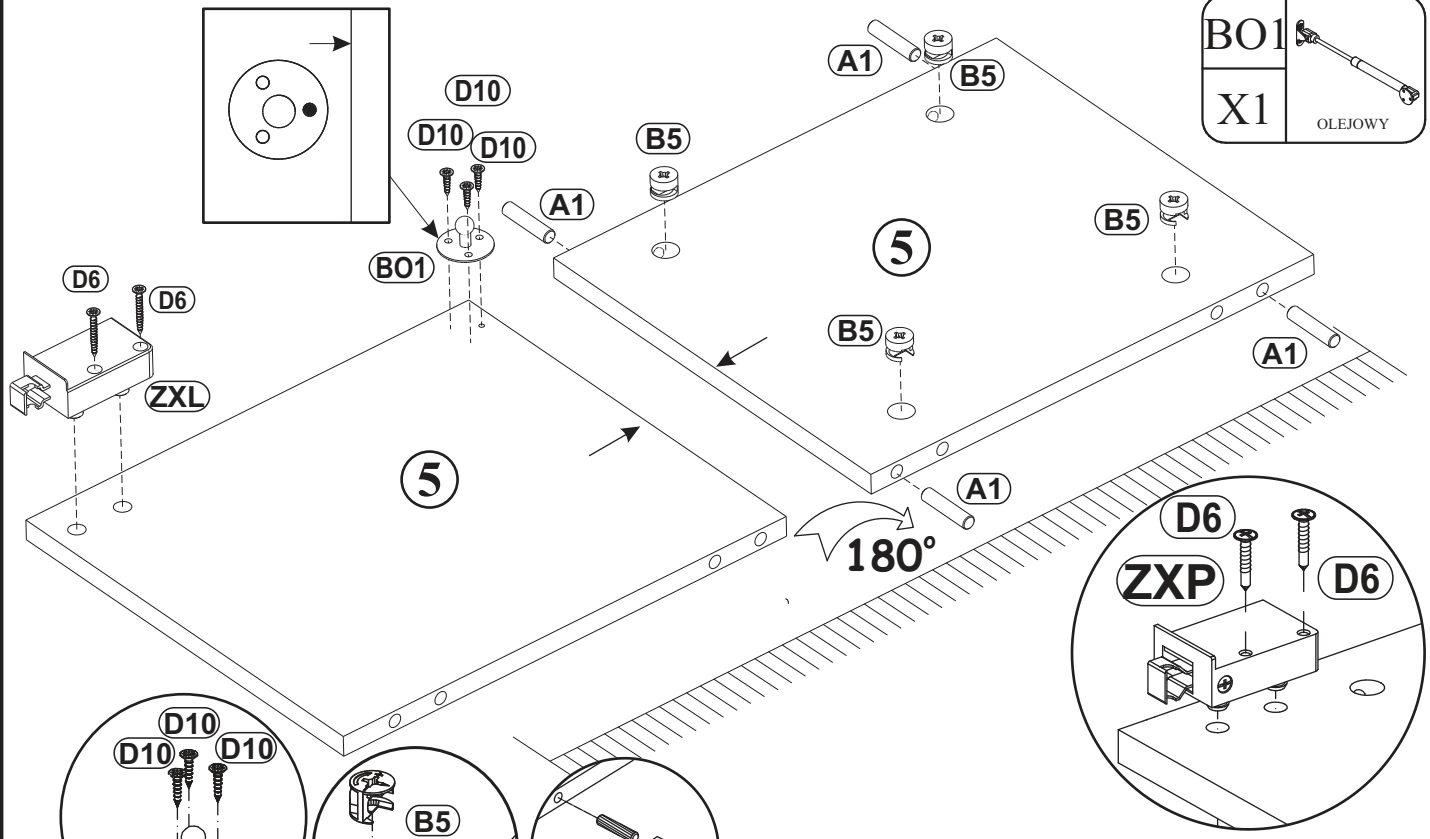
D10	 USØ3,5x13	A1	 Ø8x36	B5	 Ø15x12
X3		X4			

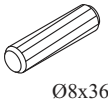

4

D10	 USØ3,5x13	A1	 Ø8x36	B5	 Ø15x12
X6		X4			

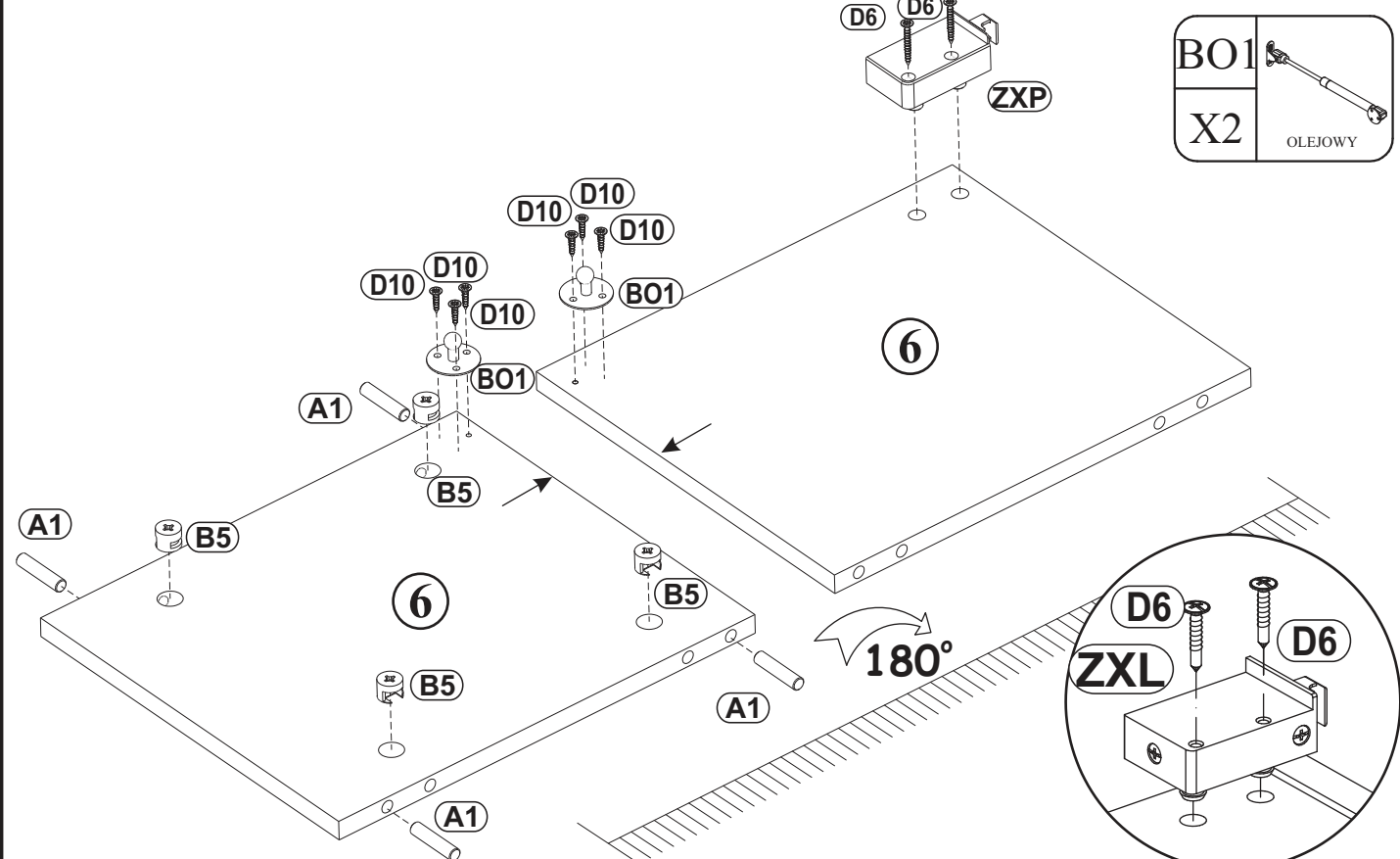

VERTI 2 TYP 30

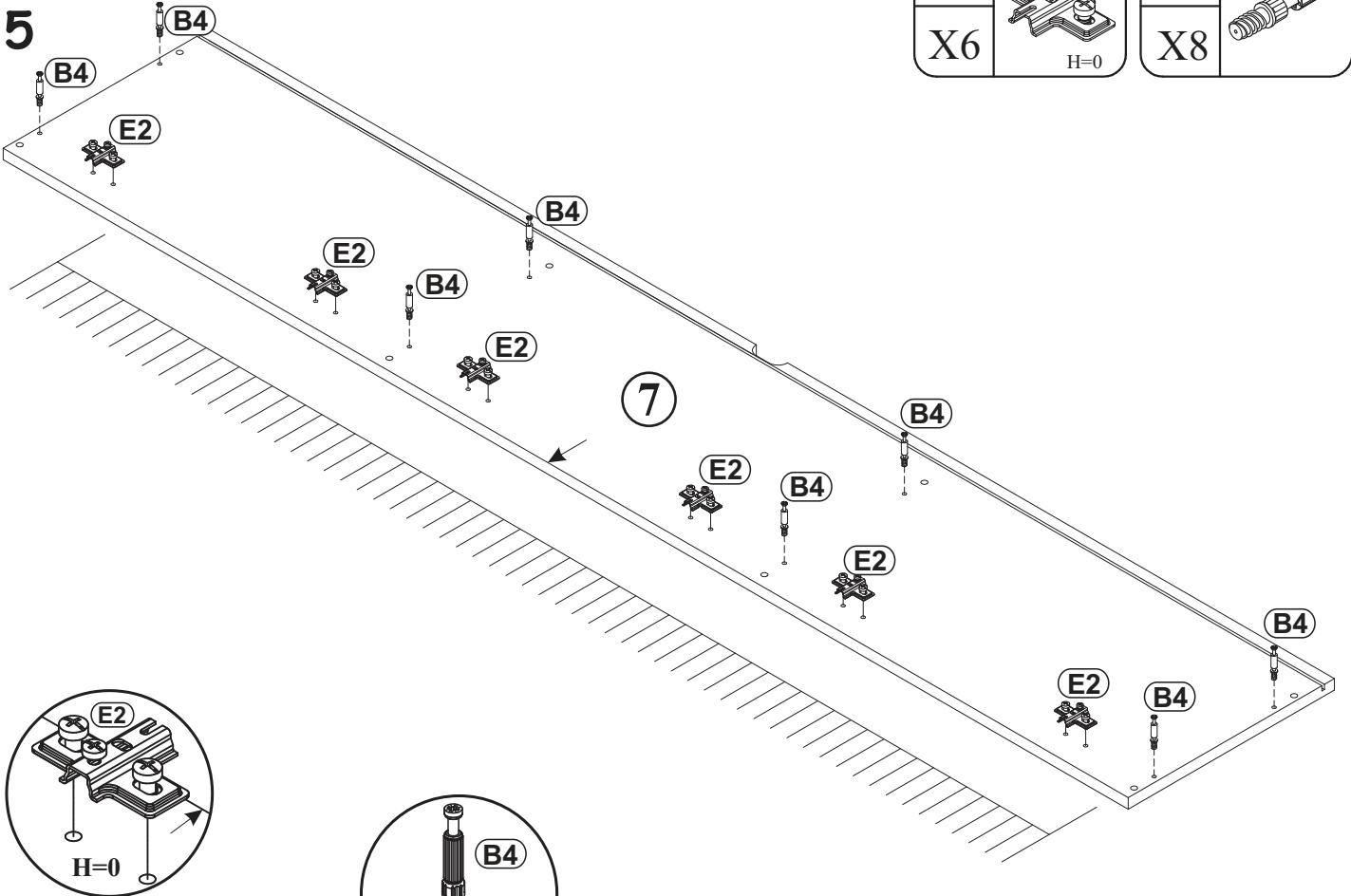

E2		B4	
X6	H=0	X8	

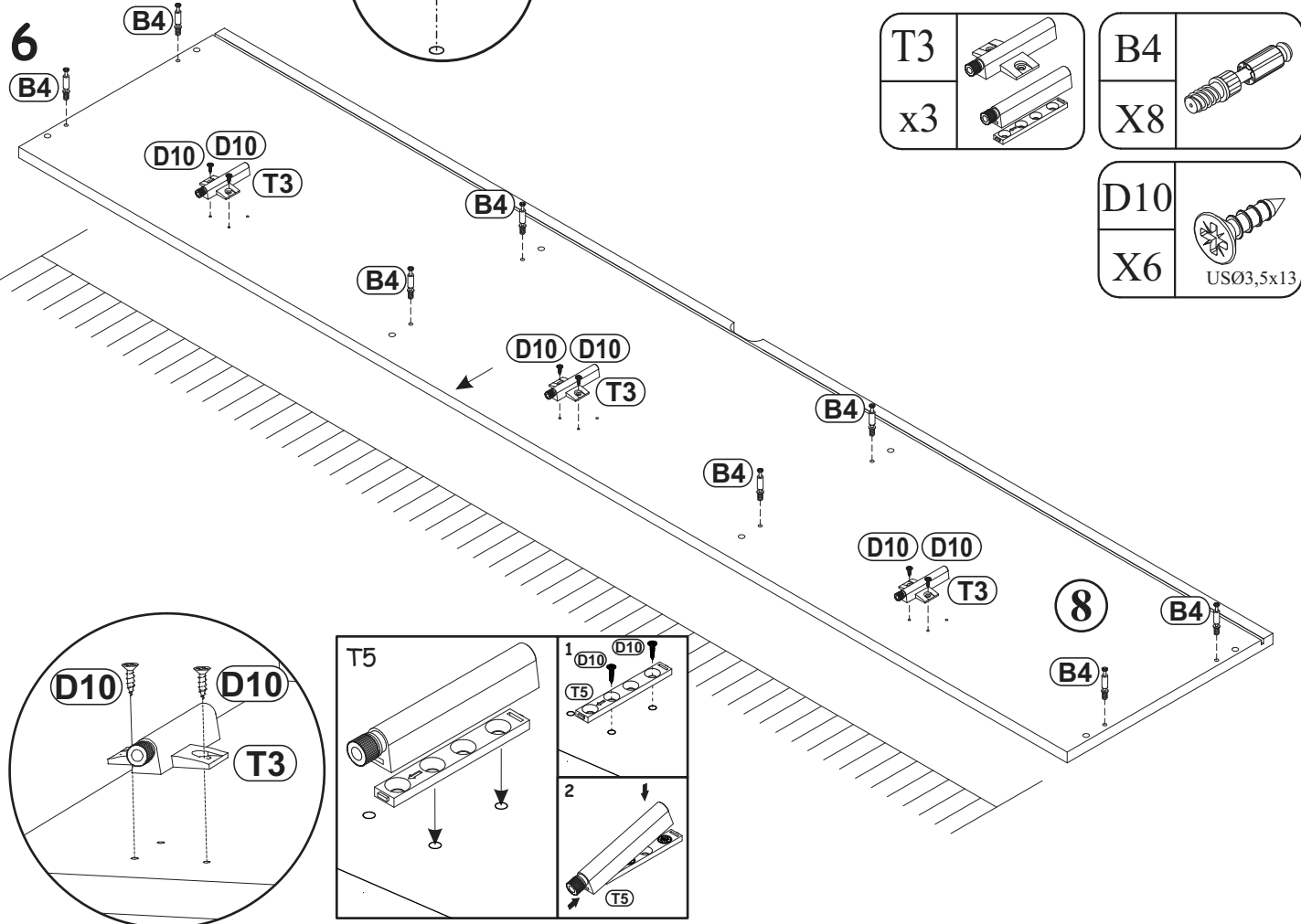

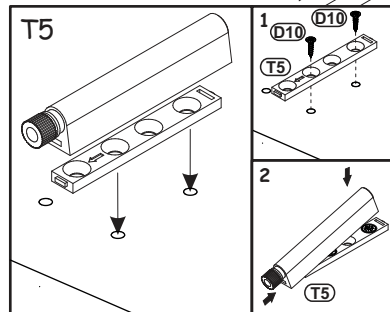

T3		B4	
x3		X8	

D10	
X6	US03,5x13



VERTI 2 TYP 30

BO1	
X3	OLEJOWY

D10	
X18	USØ3,5x13

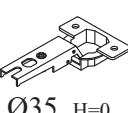
E21	
X6	Ø35 H=0

7

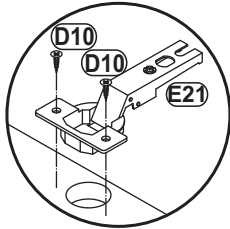
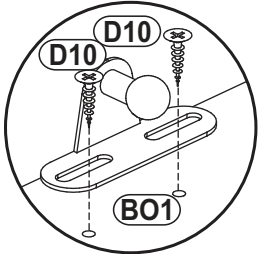
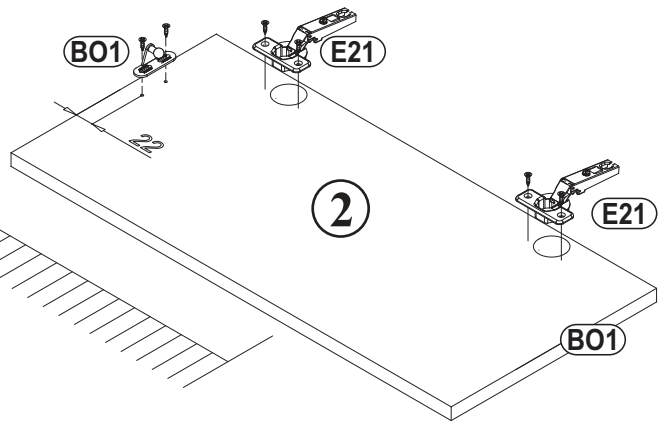
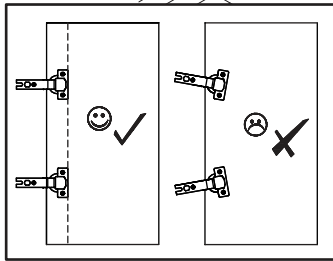
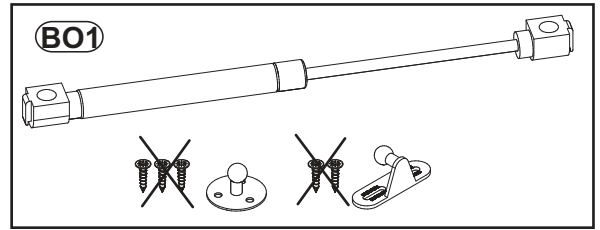
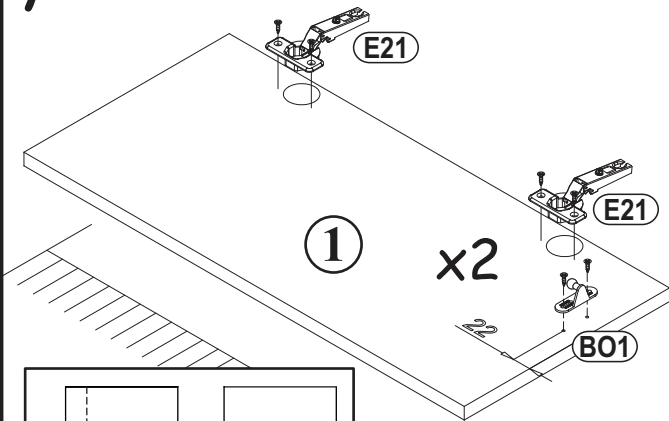

8

G5	
X8	

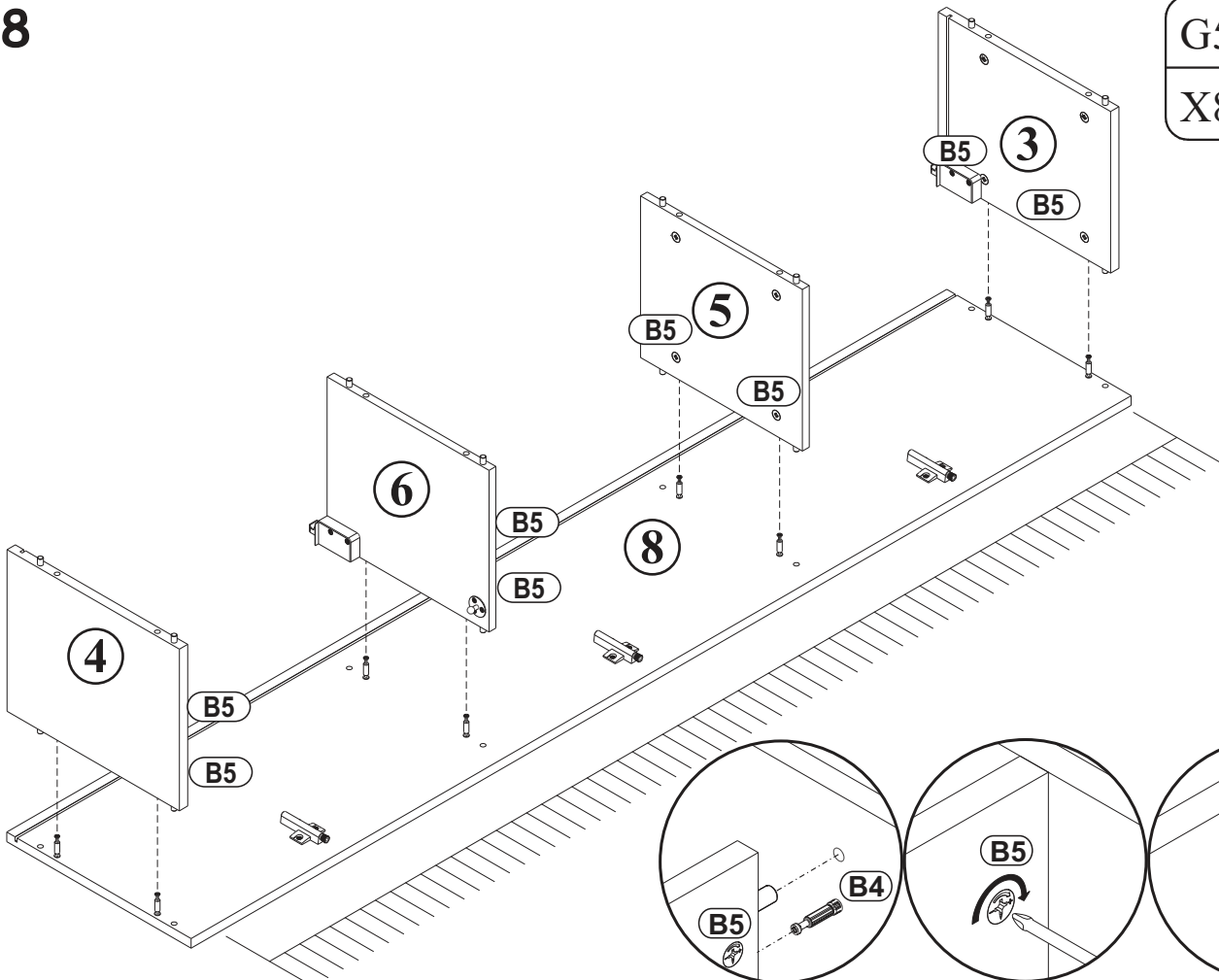





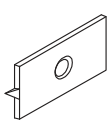

VERTI 2 TYP 30

11

G16	
X4	

UP13	
X4	UPØ3x16

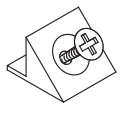
S1	
X14	

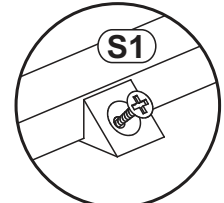
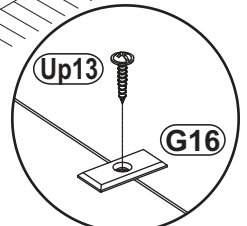
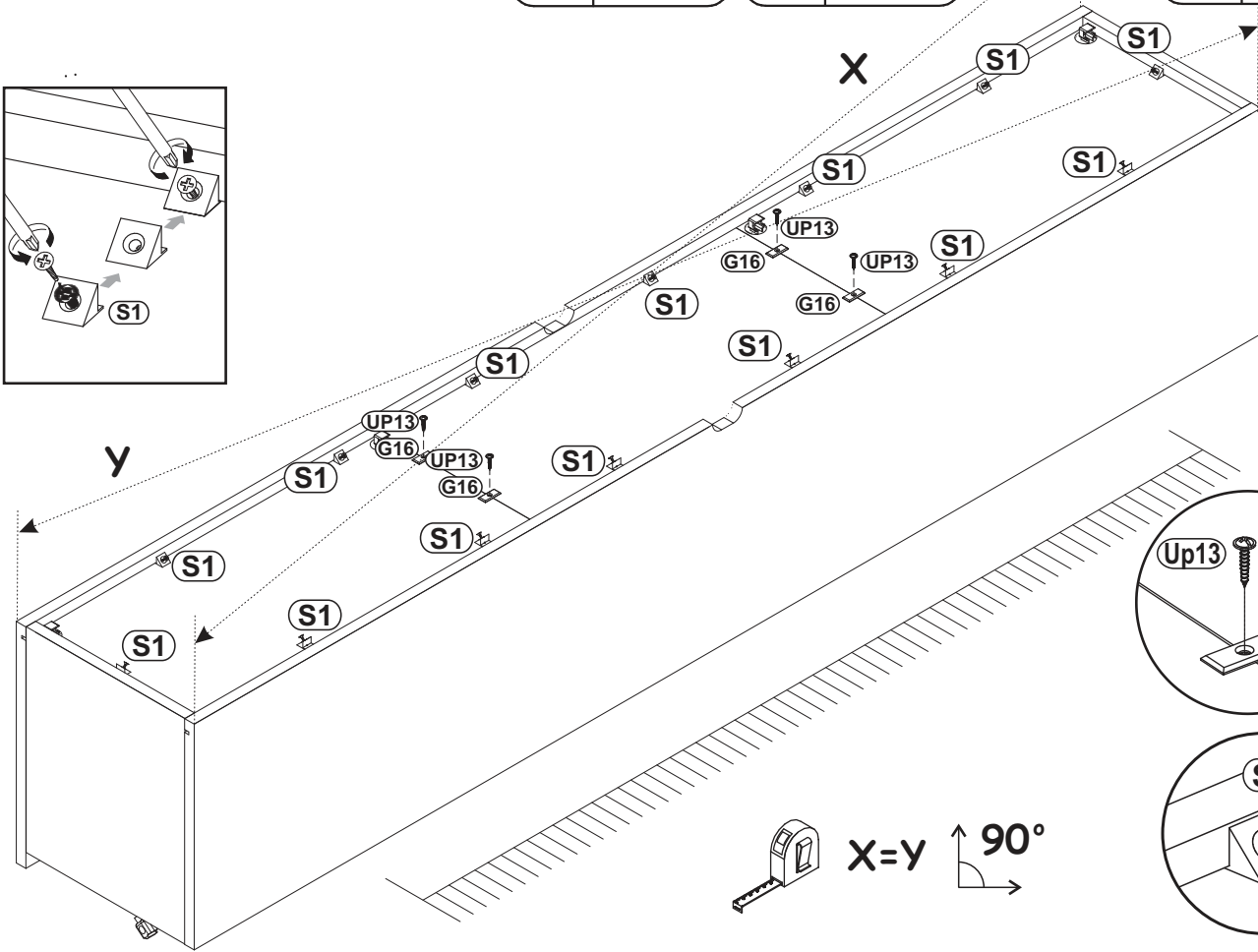
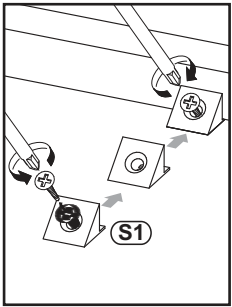

12

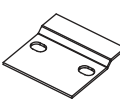
SZ7	
X4	

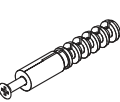
KR1	
X8	Ø8

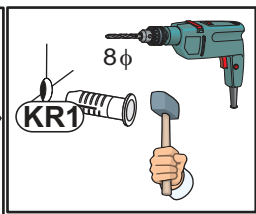
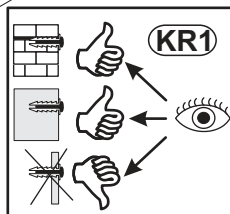
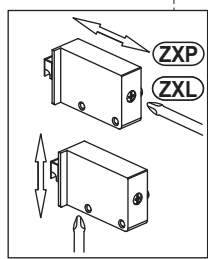
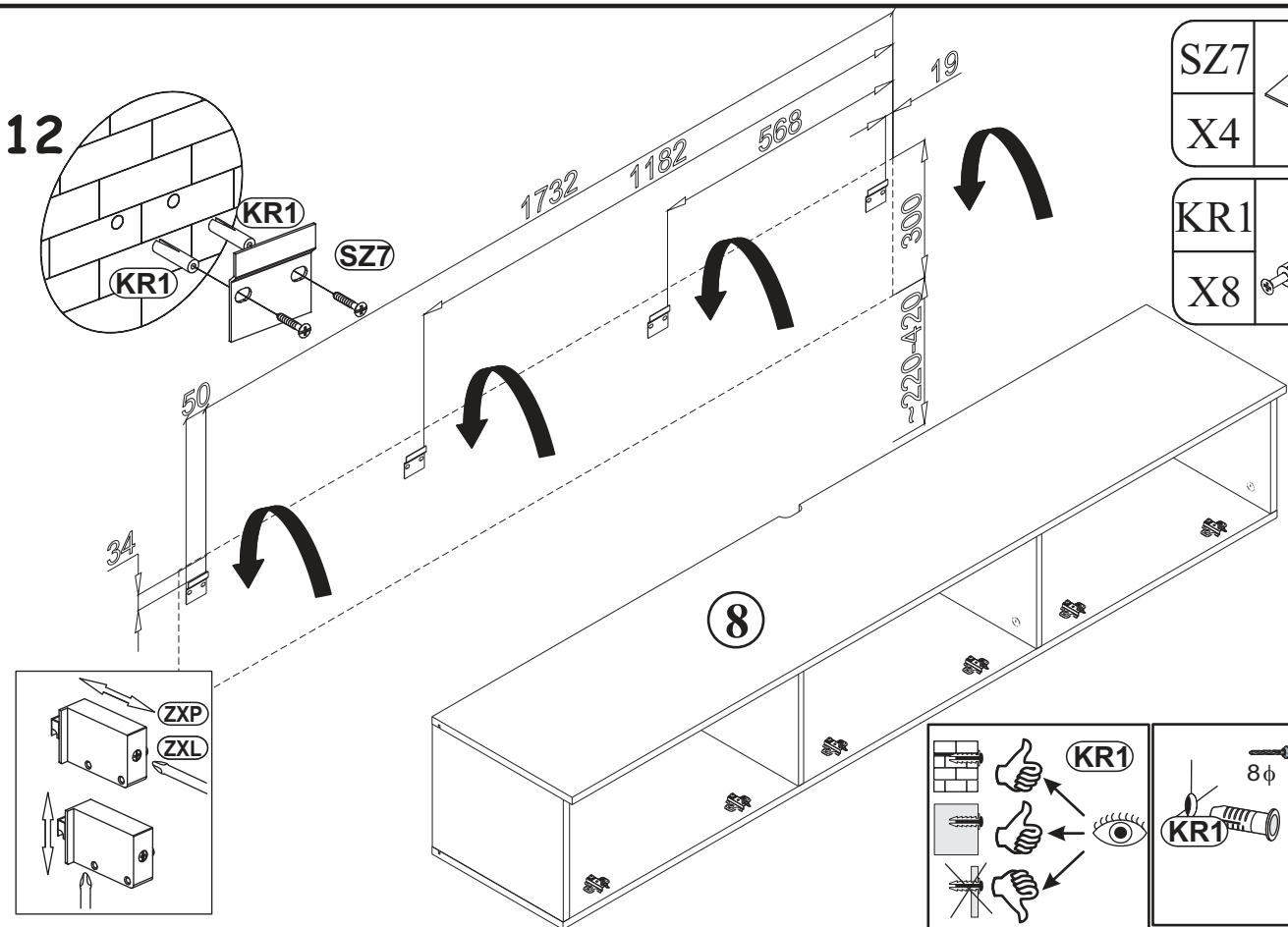

13

