

# DILLU

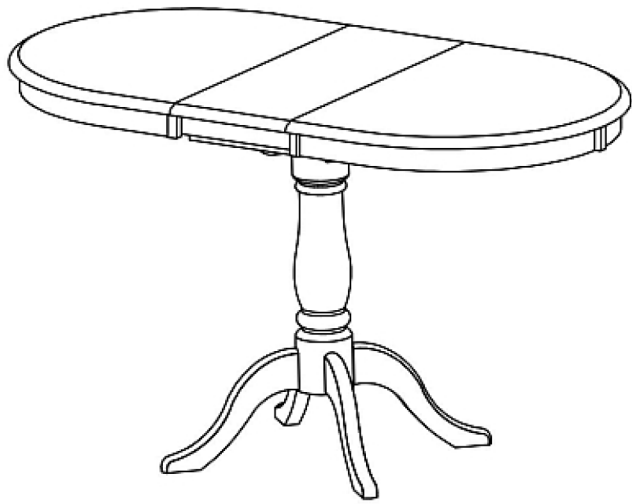

STEP 1

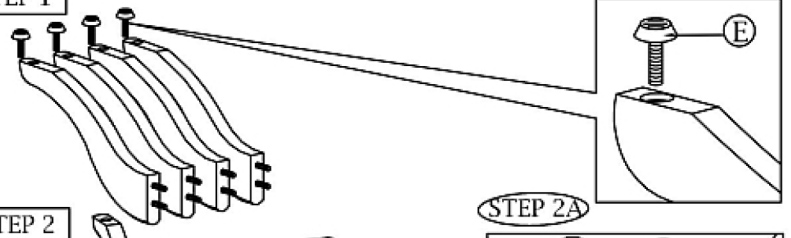

STEP 2

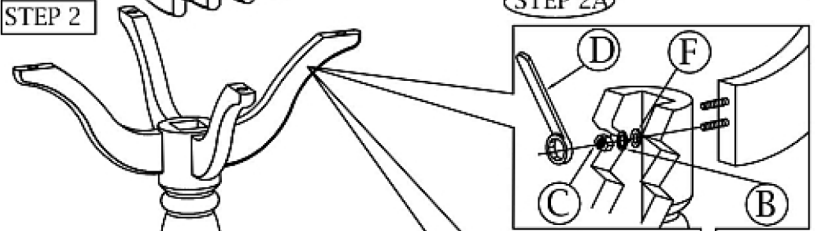

STEP 2A

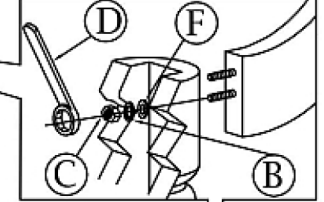

STEP 2B

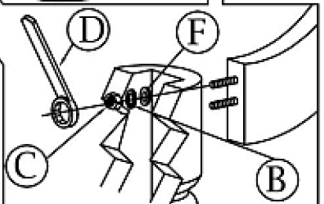

STEP 3

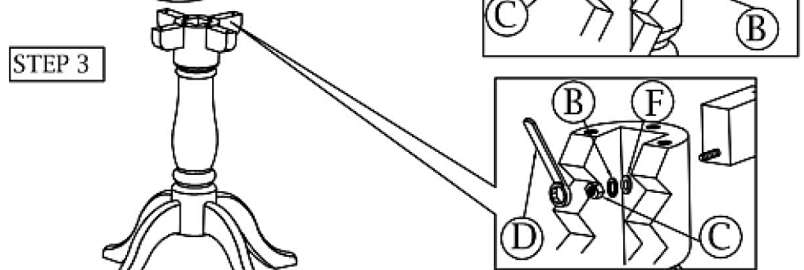

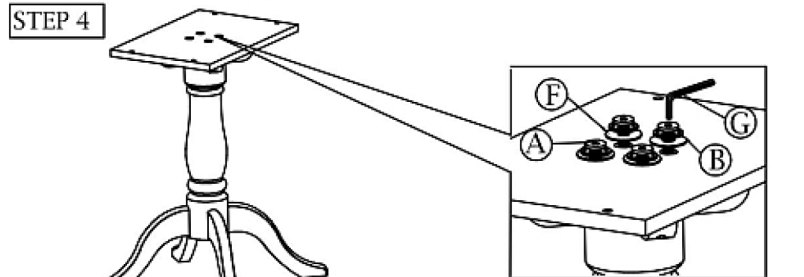

STEP 4

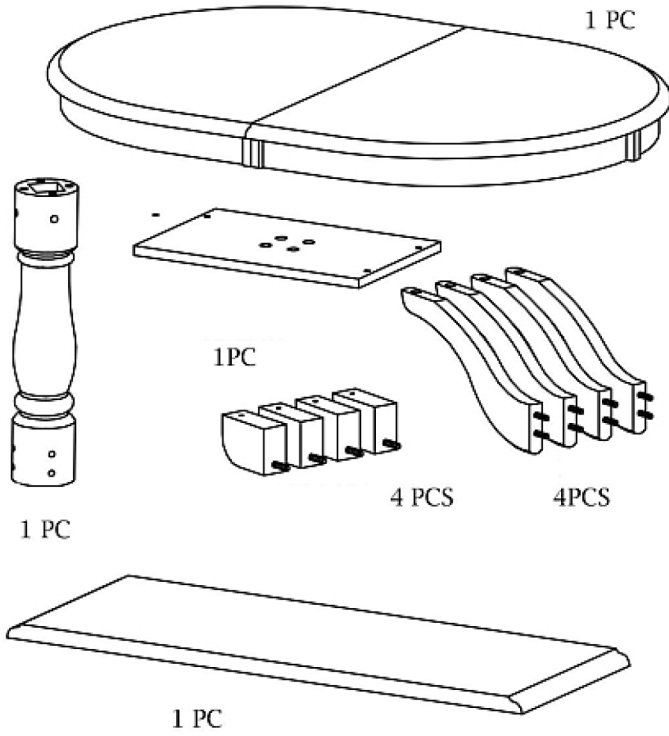
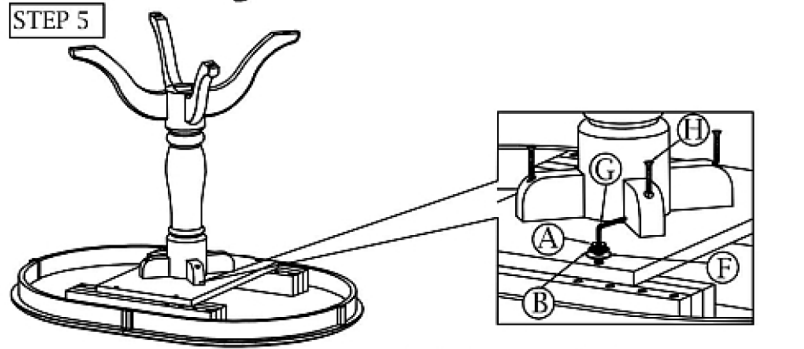

STEP 5





Part 'A'   
M6 X 40 : 8PCS

Part 'B'   
5/16" X 13.5  
20 PCS

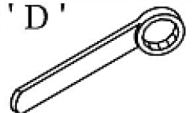
Part 'C'   
5/16" X 12.7  
12 PCS

Part 'D'   
13MM : 1 PC

Part 'E'   
M6 X 16 : 4PCS

Part 'F'   
5/16" X 17  
20 PCS

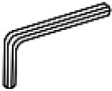
Part 'G'   
M4 : 1 PC

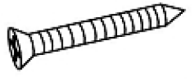
Part 'H'   
M4 X 32  
4PCS

