

# LENI

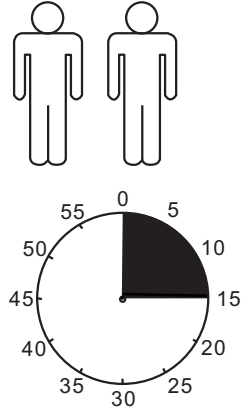

1

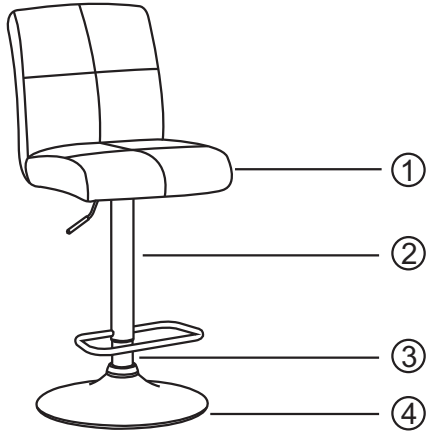
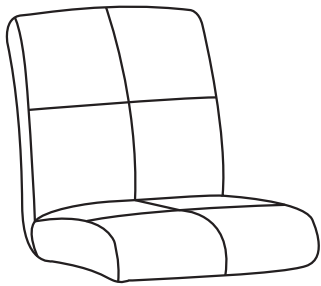

2

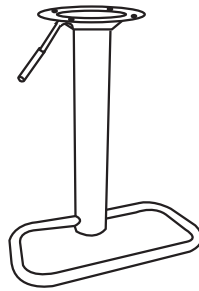

3



4

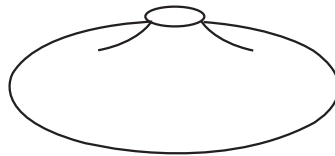

1	1x
2	1x
3	1x
4	1x



1/1



1x

B

M6X16



2x

C

M6X22



2x

D

Ø22XØ10X5



2x

E



1x

1.

1.

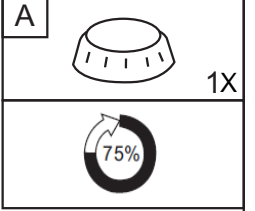
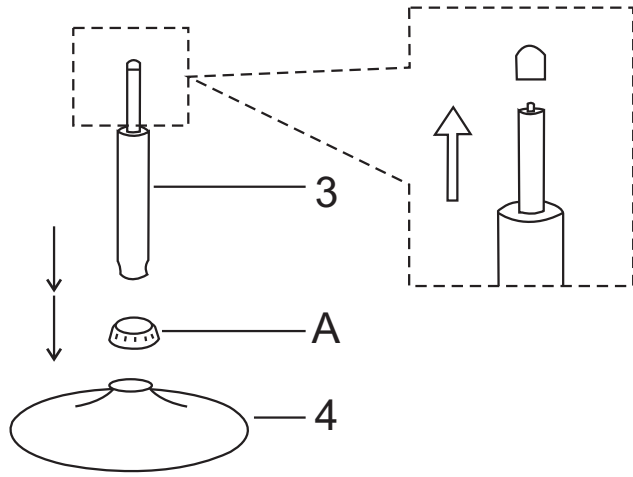

2.

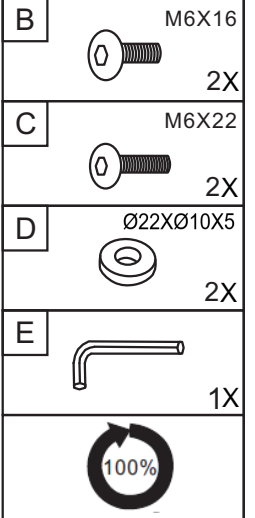
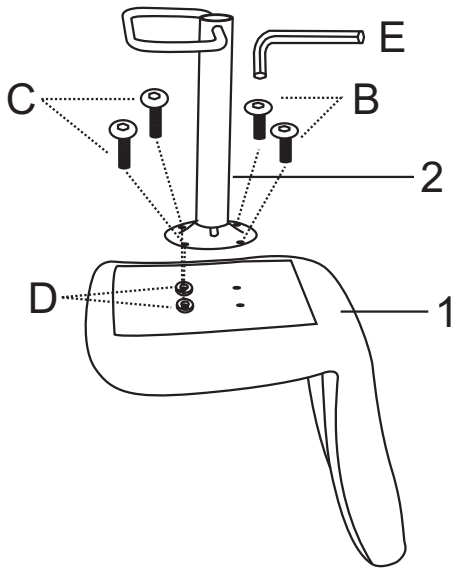

3.

