

# ILSA

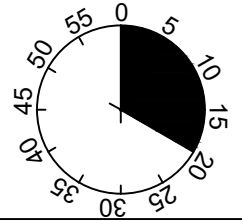
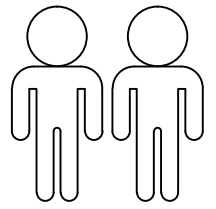
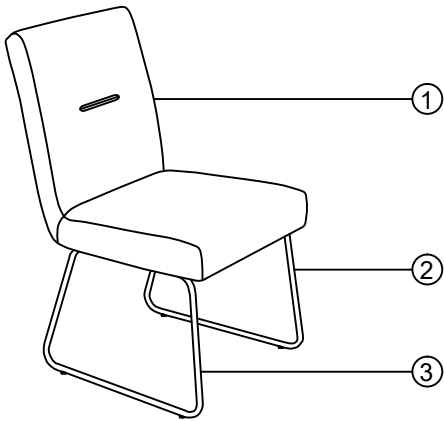

1

2

3

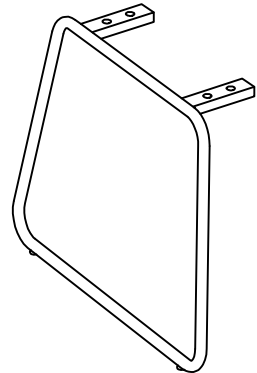
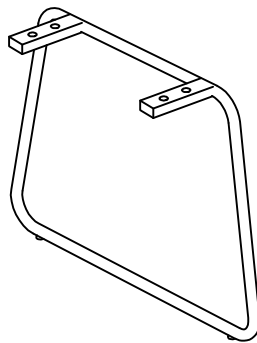
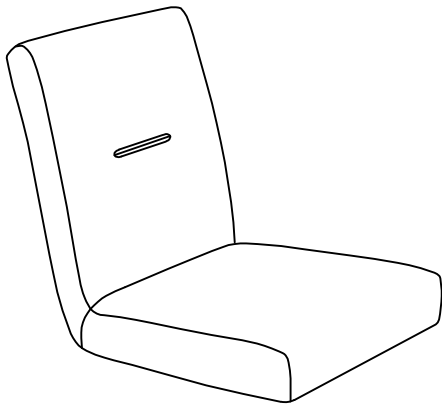

1	1X
2	1X
3	1X

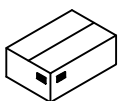

1/1

A

M8x35

B

Ø18xØ8x1.5

C

5MM

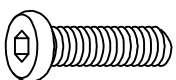

8x



8x

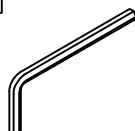



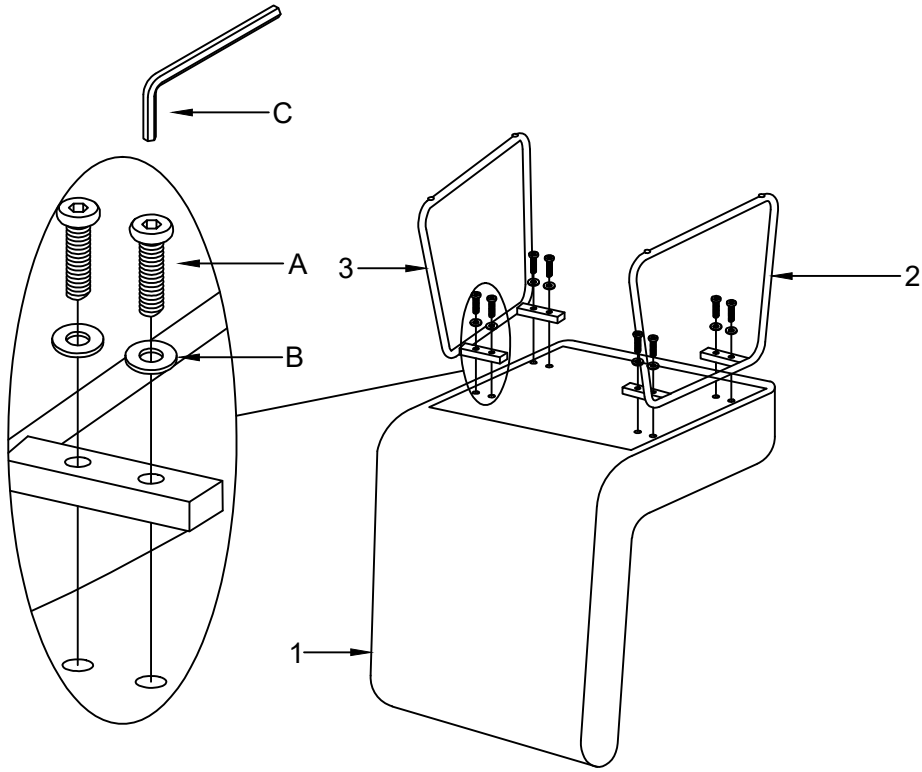

1x

I.

1



- A M8x35  
  
8x
  - B  $\varnothing 18 \times \varnothing 8 \times 1.5$   
  
8x
  - C 5MM  
  
1x
- 

2

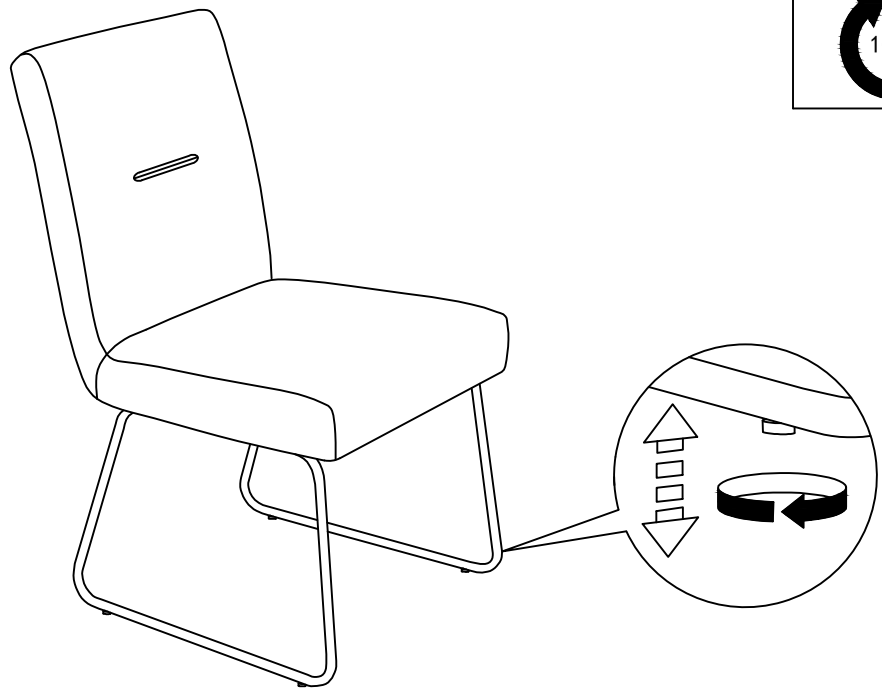

- C 5MM  
  
1x
- 