

# R3 600x700x320

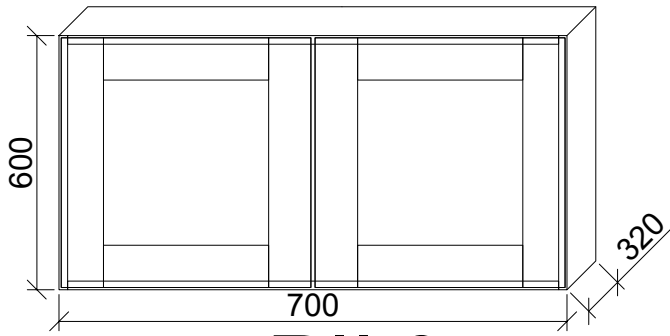

## RII 3

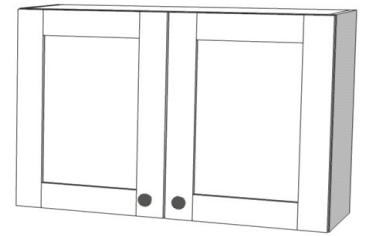
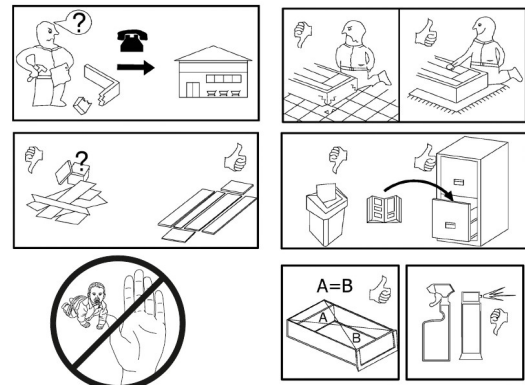
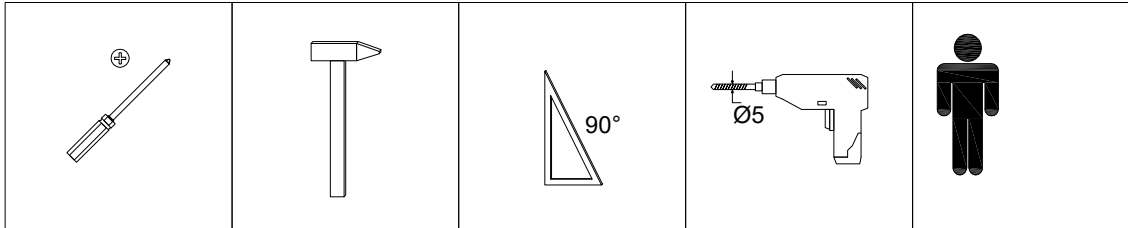

A	x8	C2	x20	F	x40	G	x2	J1	x2	M	x4	L	x2
		3,5x16mm 											

O3	x8	O9	x1	O11	x8
Ø13mm 					7x50

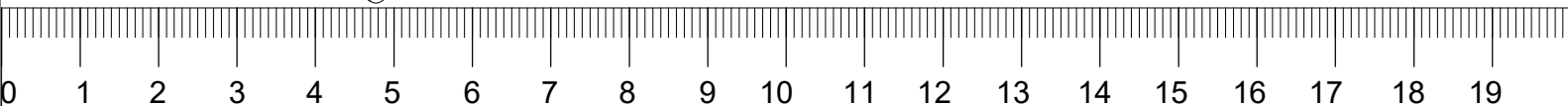
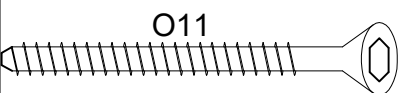

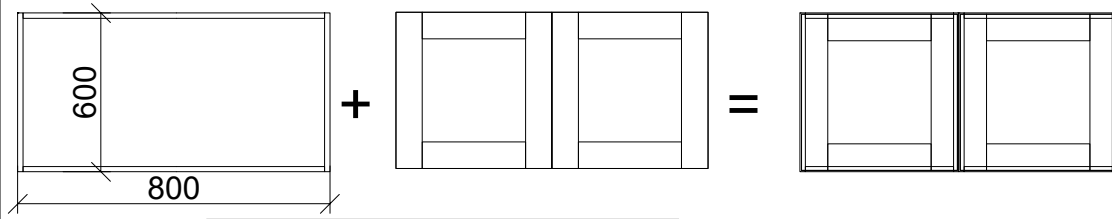
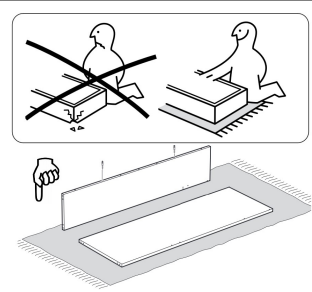

I

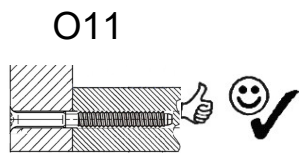
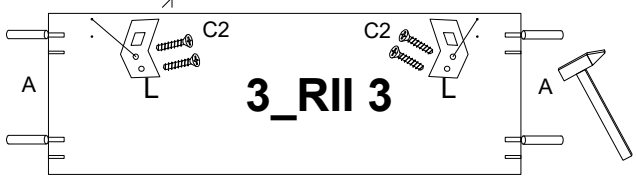

II

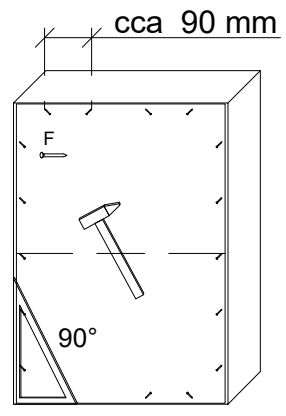
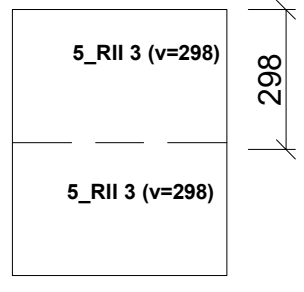
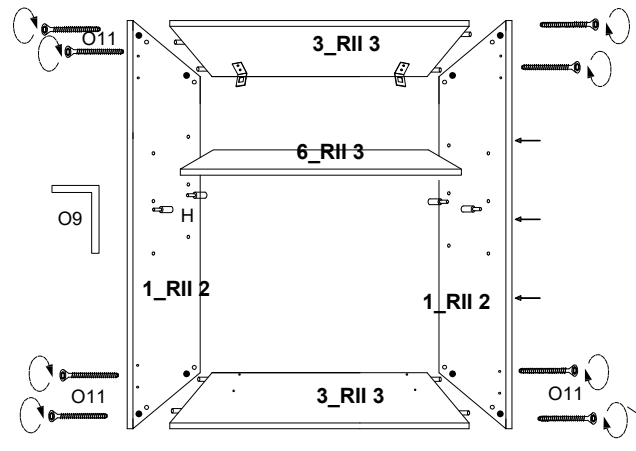

III

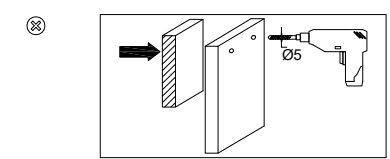
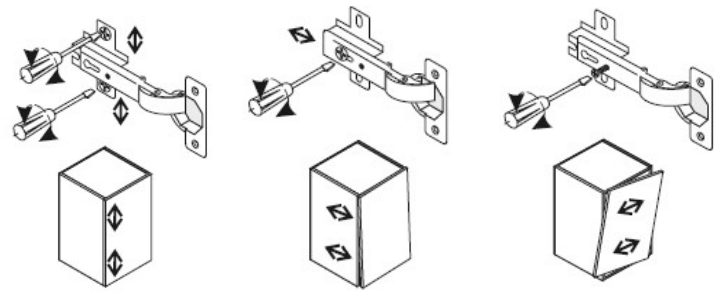
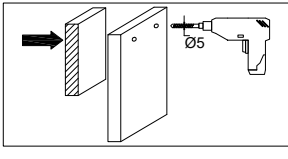
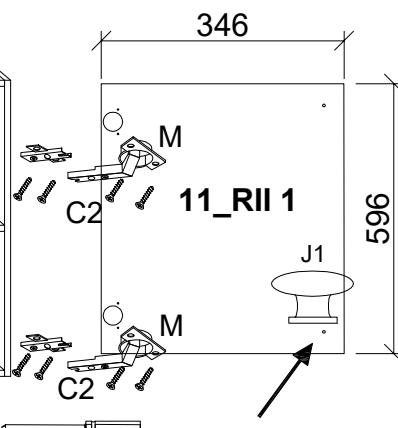
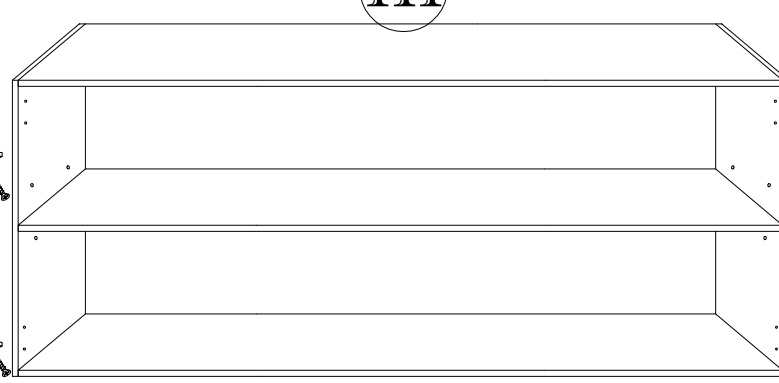
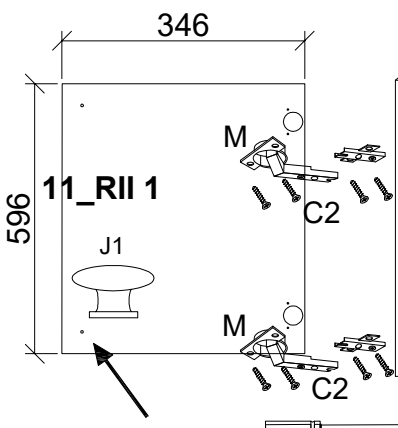

G x2

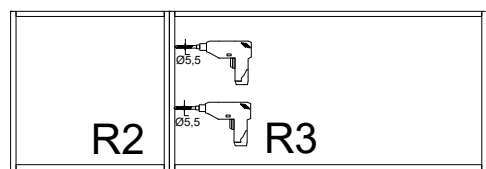

2/2