

RII 4

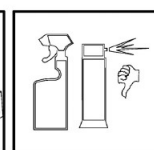

A	x8	C2	x12	F	x20	G	x2	J1	x1	M	x2	L	x2
8x40		3,5x16mm								Ø35mm			

N	x1	O3	x8	O9	x1	O11	x8
		Ø13mm		4mm		7x50	

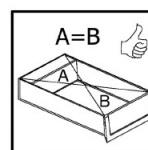
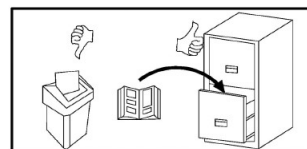
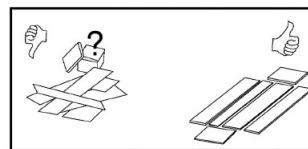
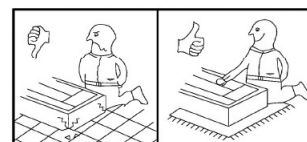
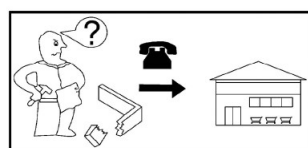
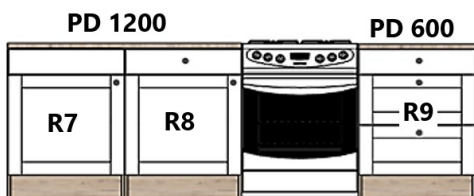
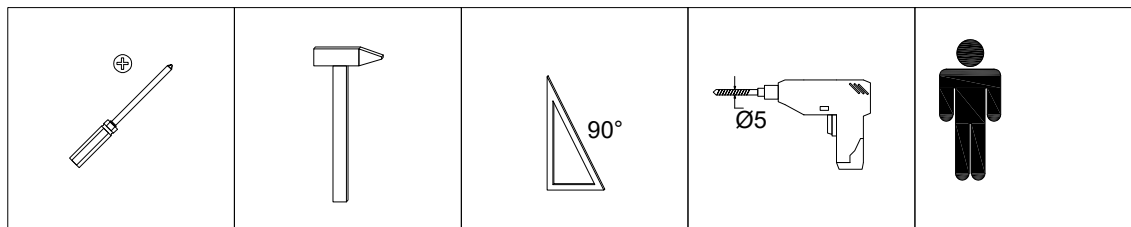
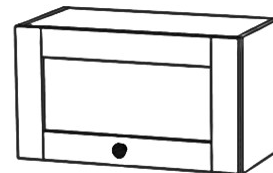
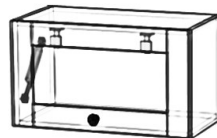
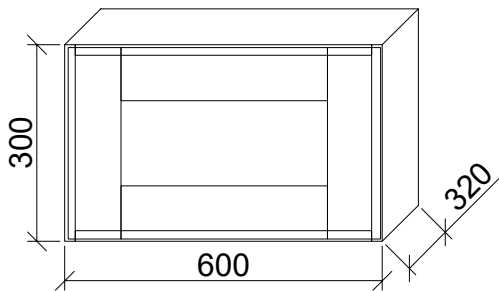
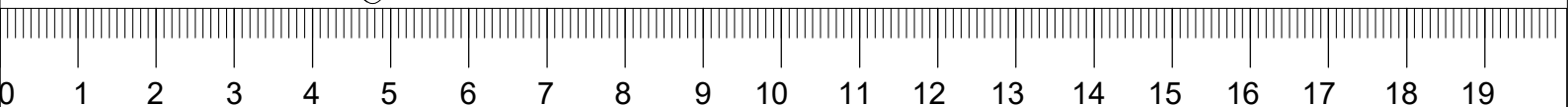
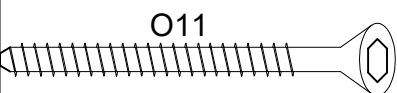

R4

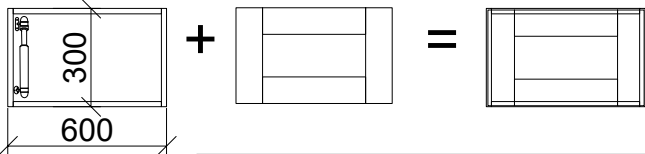
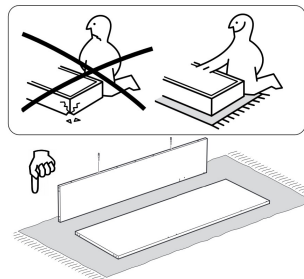

I

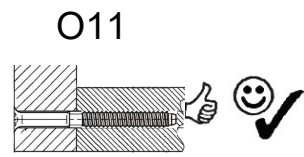
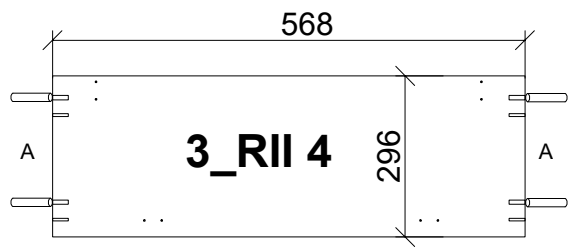
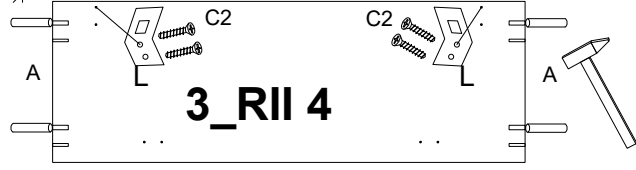

II

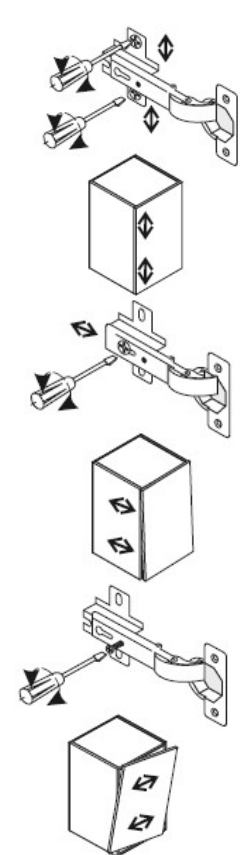
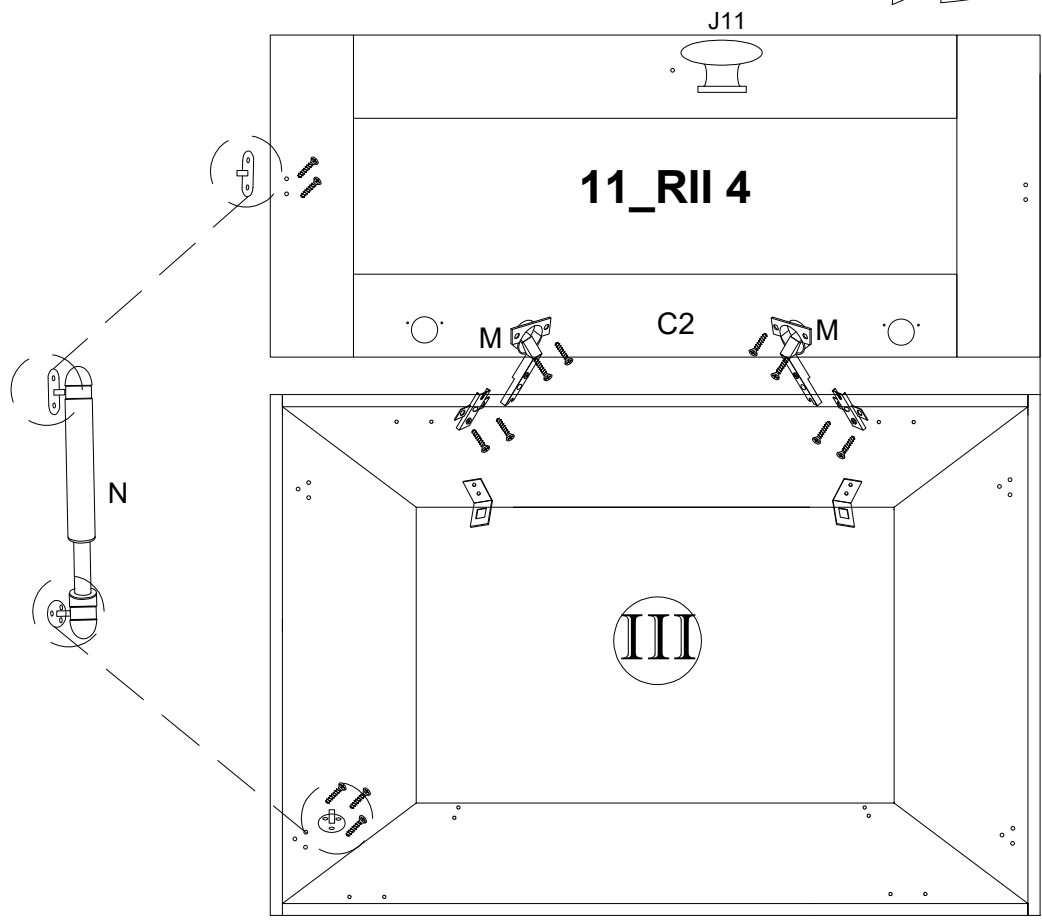
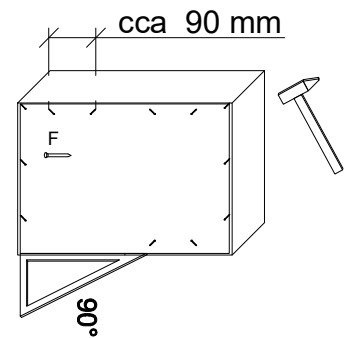
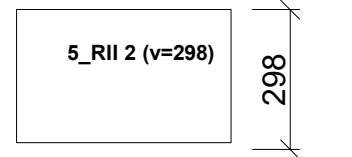
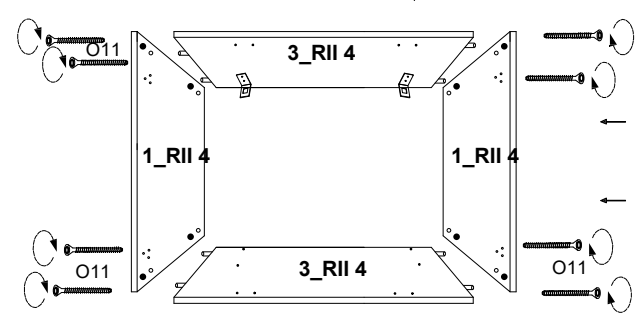

G x1

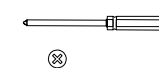
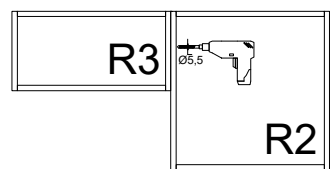

2/2