

1	1444	358	1	1
2	1444	380	1	1
3L,3R	1273	358	2	2
4L,4R	1273	322	2	2
5	1446	40	1	1
6L,6R	1242	506	2	3
7	523	290	2	3
8L,8R	524	335	2	1
9	523	300	2	1
10U	329	300	1	1
10D	330	350	1	1
11	1272	55	2	2,3
12L,12R	305	180	4	2
13	290	180	2	2
14	300	297	2	2
15	350	246	1	2
16	350	308	1	2
17	680	350	1	3
18	1284	536	2	3
19	1284	344	1	2

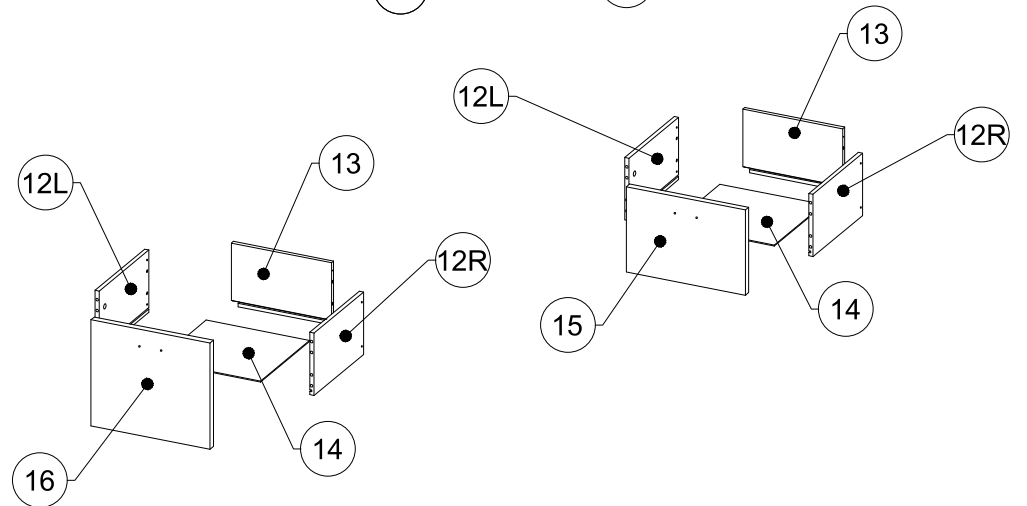
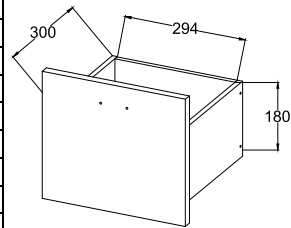

Ø15x12mm			
A	x36	E2	x12
C	x44	G	x36
Ø8x30mm			
D	x56	H	x22
E1	x8	P	x2
		Ø3x16mm	
I	x12	I1	x12

K	x8
K2	x8
Ø3,5x13mm	
K1	x16

L-300mm		Ø3,5x13mm	
J	x2	J2	x8
Ø6x11mm			
J1	x8	H	x4
Ø15x10mm			
B	x8	G1	x8
Ø3,5x30mm			
F	x8		

L-80mm	
L	x5
M4x25mm	
L1	x10



U	x2
U1	x1

LED-Beleuchtung:  
Zeta S 3S

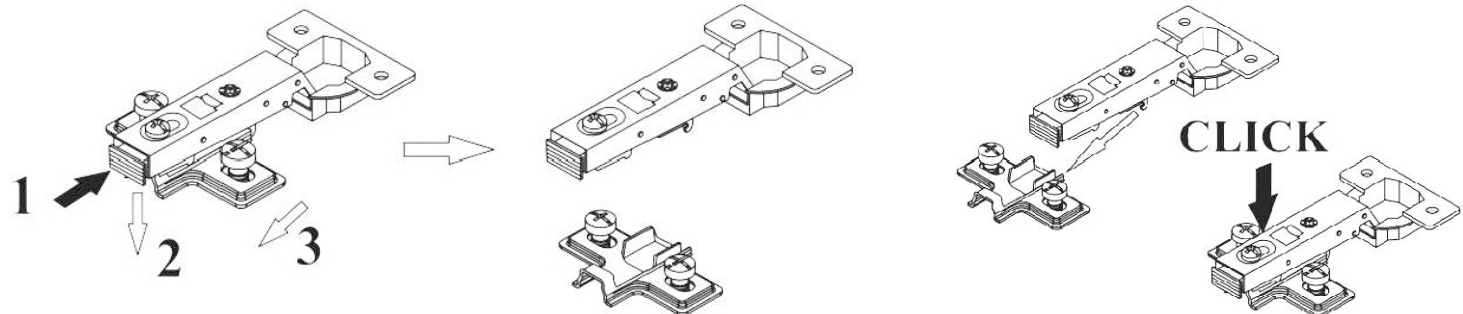

55x55x20	
M	x6
Ø4x30mm	
M1	x24

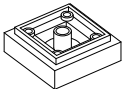
O	x2
O1	x2
Ø3,5x13mm	
O2	x4

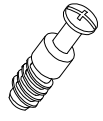

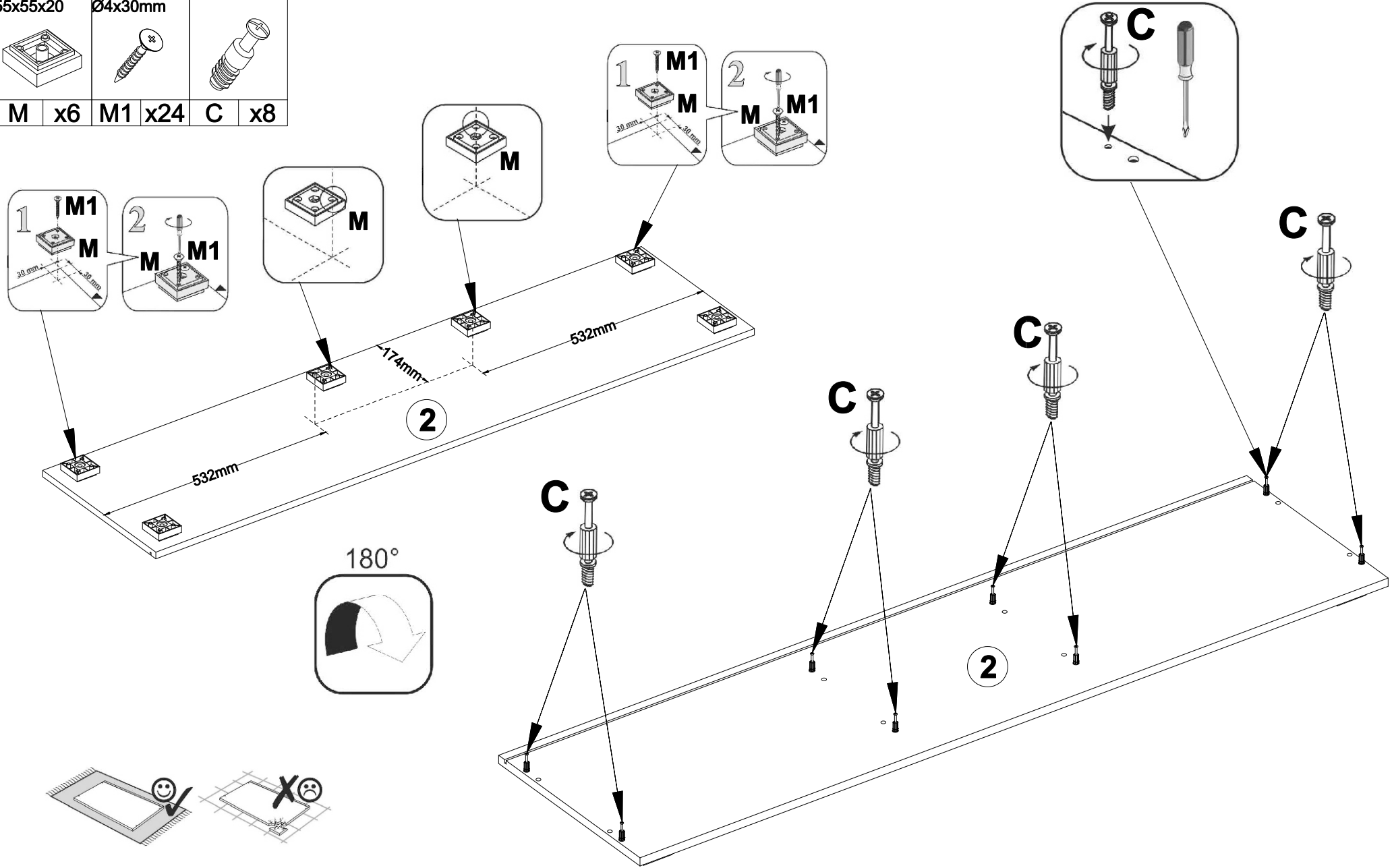
55x55x20	Ø4x30mm	
		
M x6	M1 x24	C x8



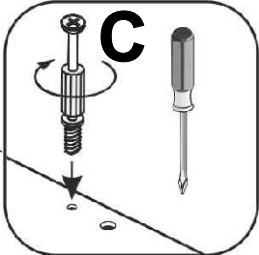
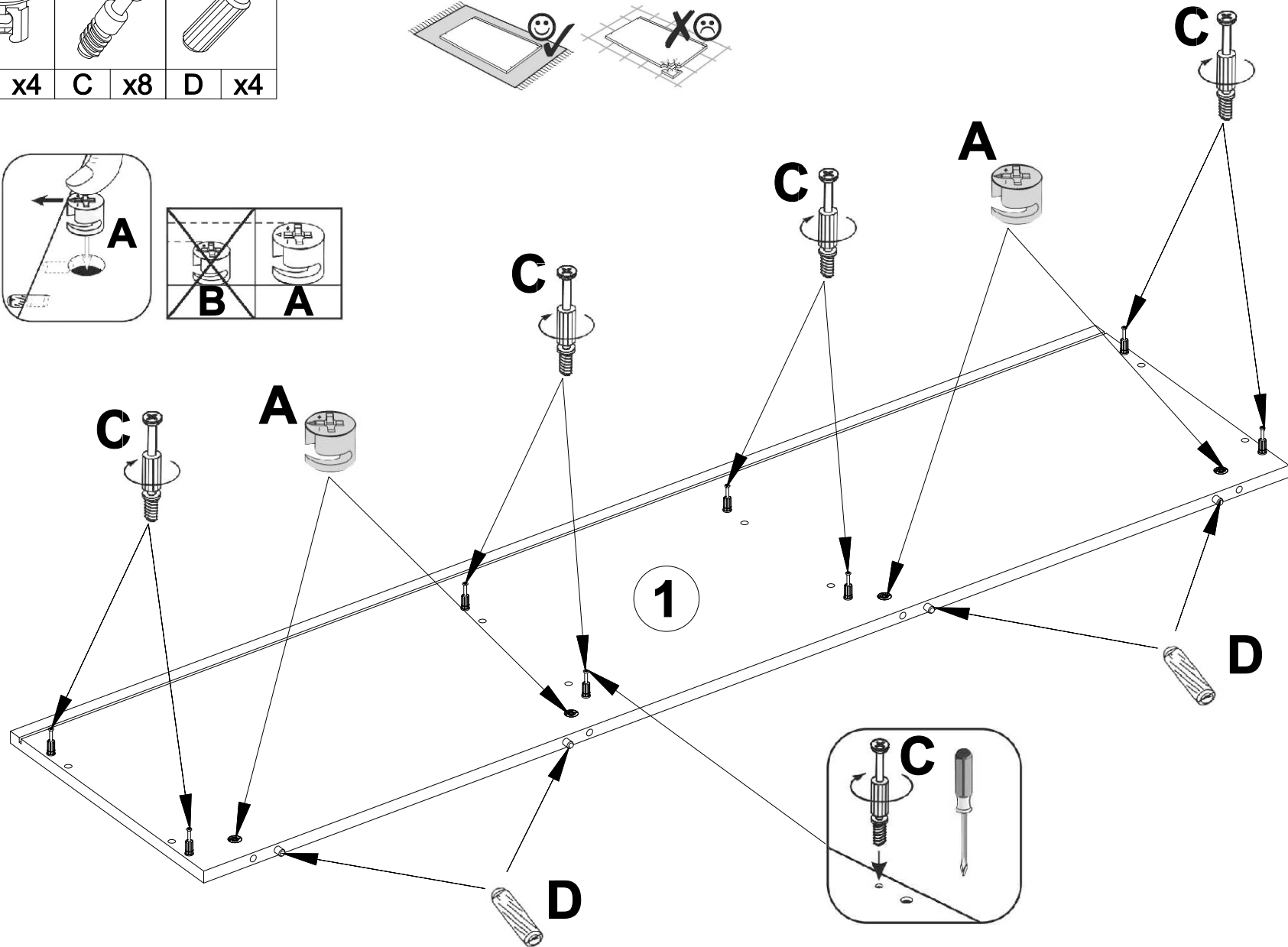
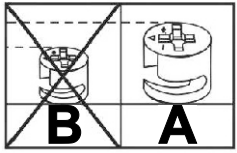
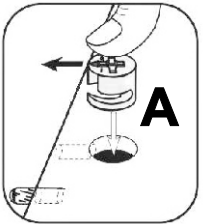
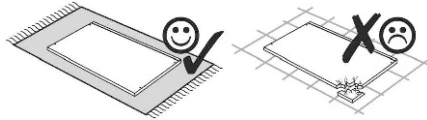

		
A x4	C x8	D x4



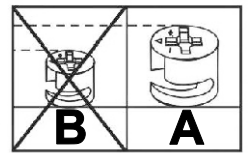
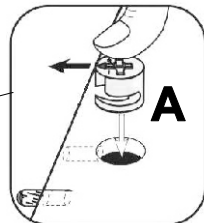
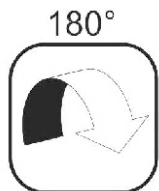
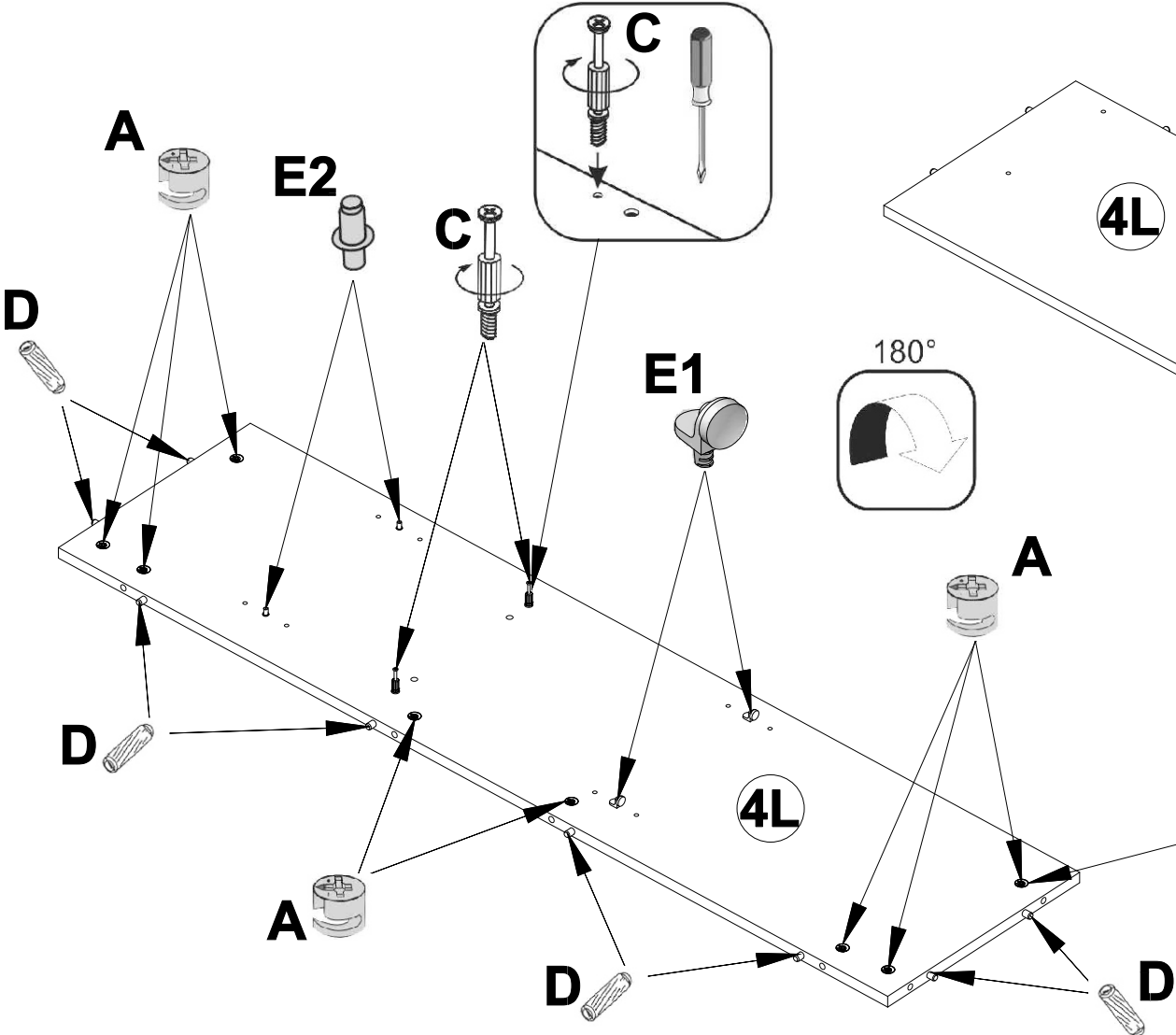
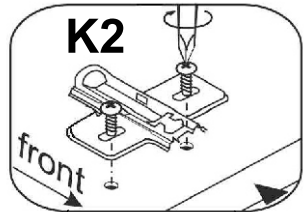
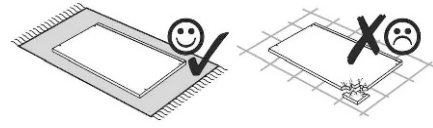

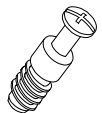
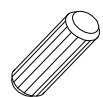

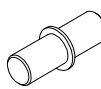

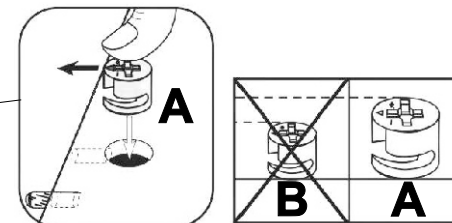
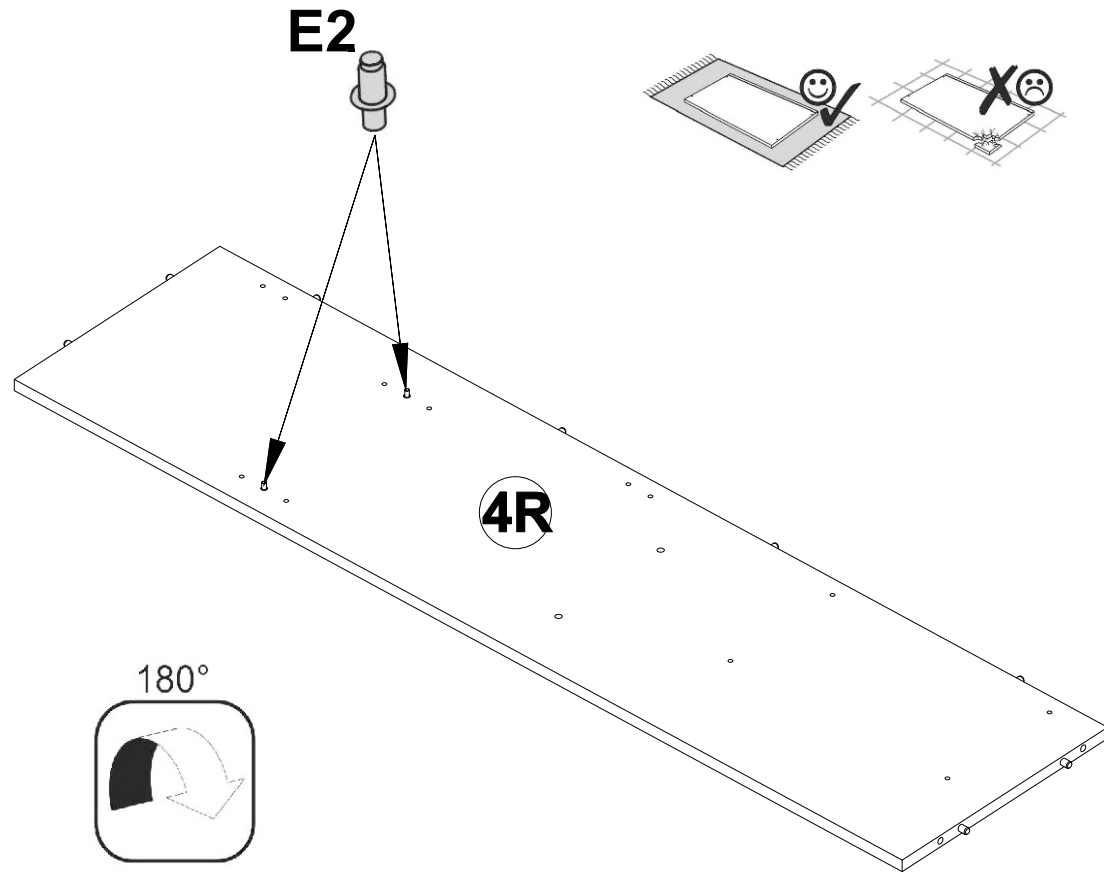
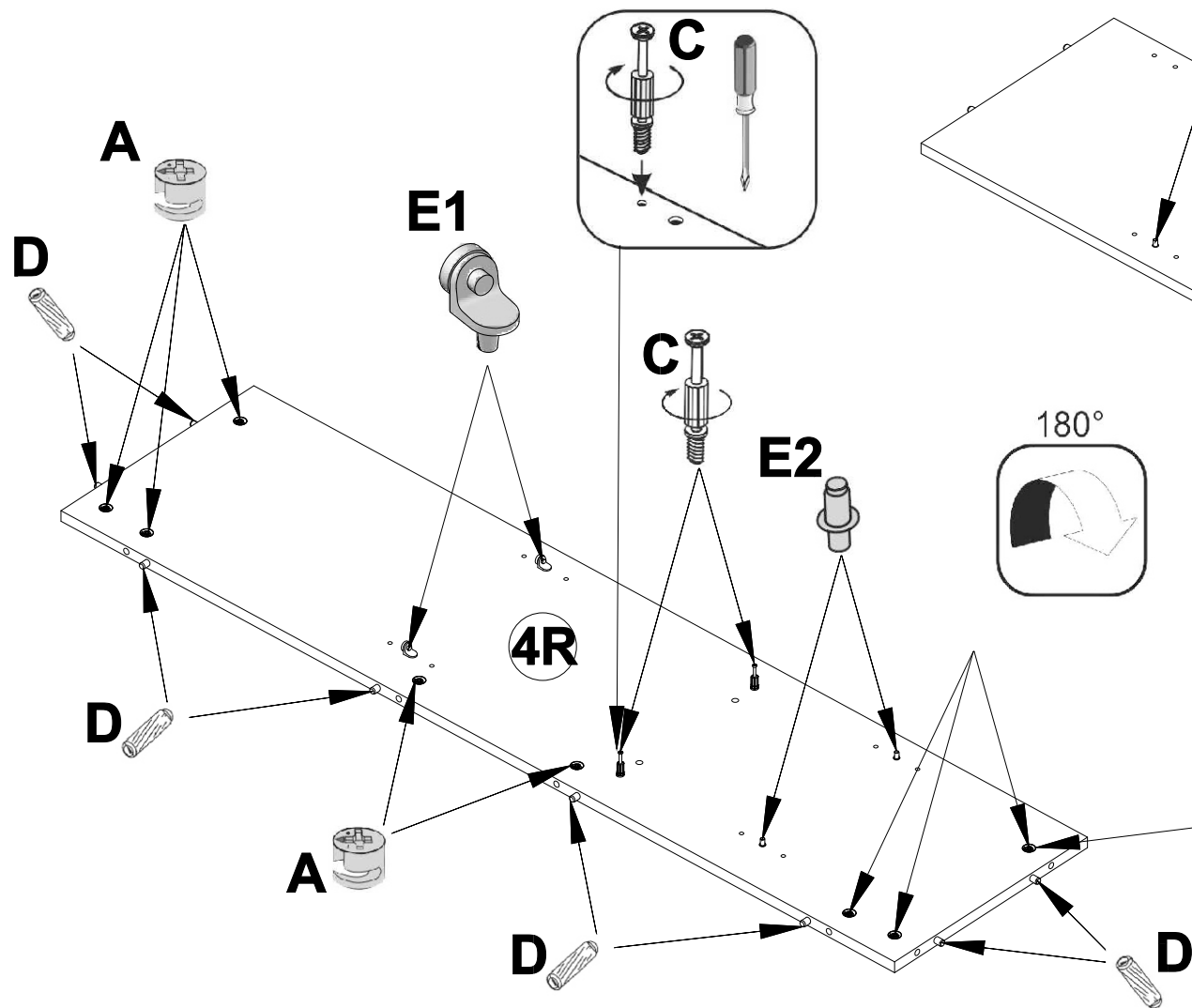
Ø15x12mm	Ø8x30mm				
A x8	C x2	D x8	E1 x2	E2 x4	K2 x2





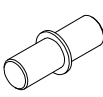

Ø15x12mm		Ø8x30mm		
				
A x8	C x2	D x8	E1 x2	E2 x4

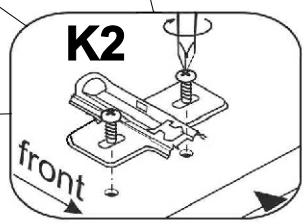
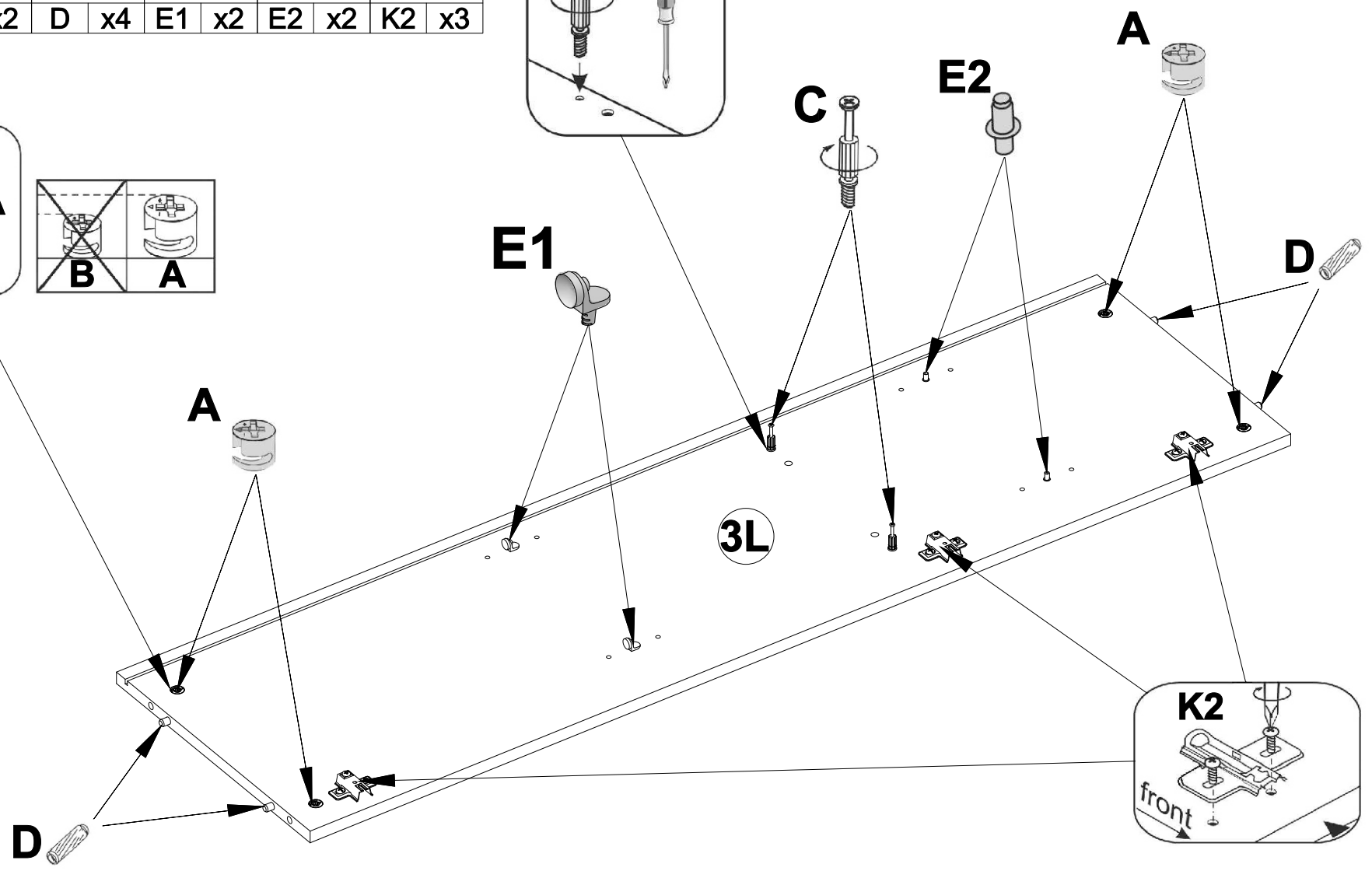
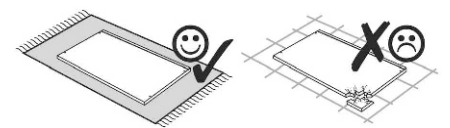
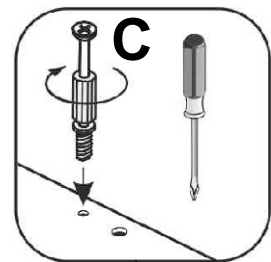
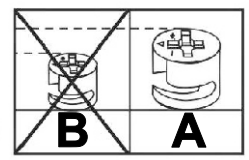
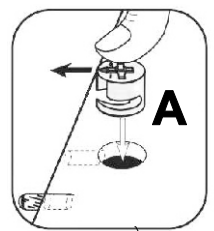

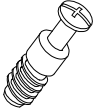

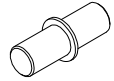
 Ø15x12mm	 Ø8x30mm	 Ø8x30mm			
<b>A</b> x4	<b>C</b> x2	<b>D</b> x4	<b>E1</b> x2	<b>E2</b> x2	<b>K2</b> x3



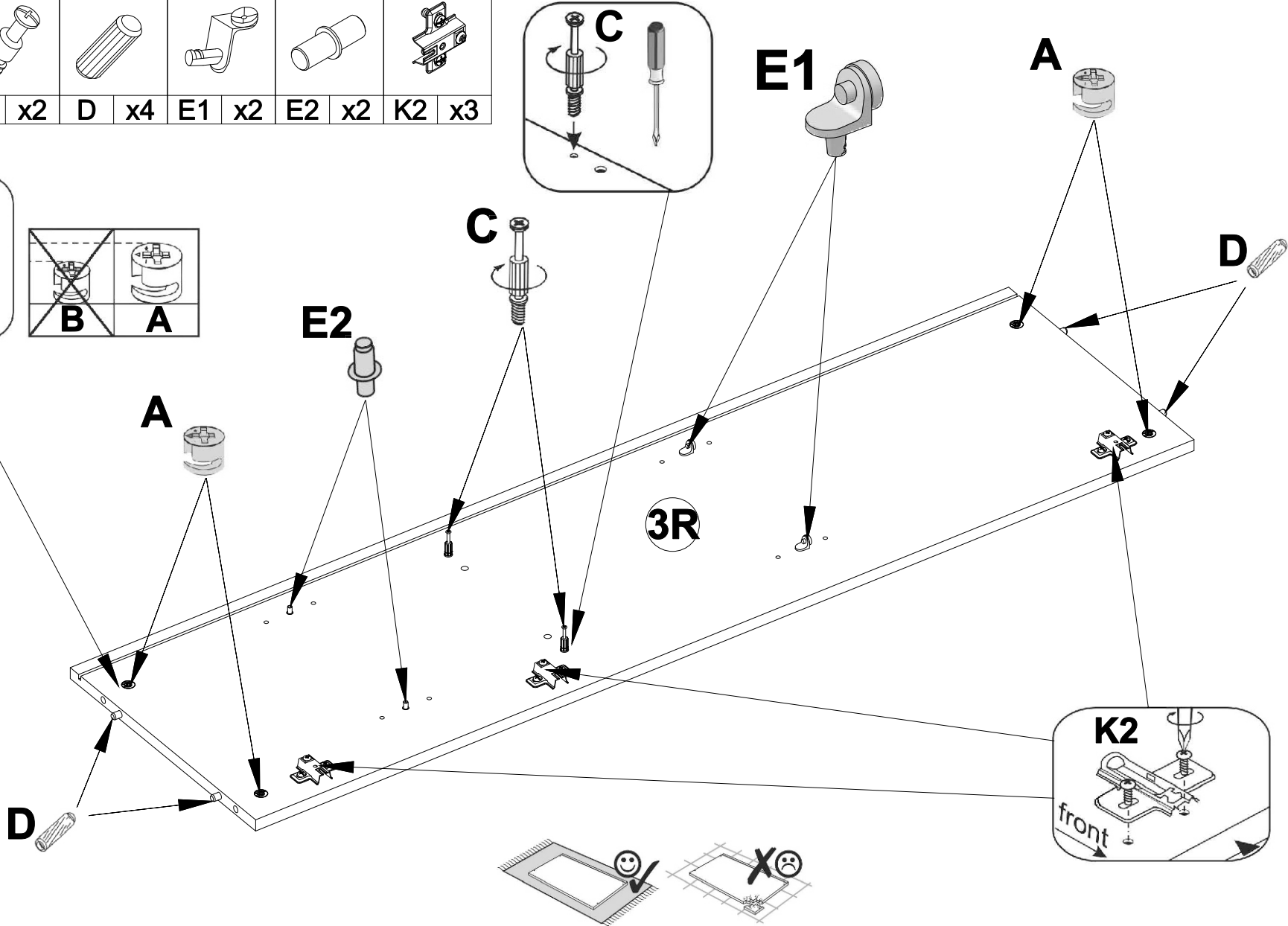
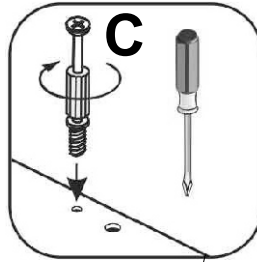
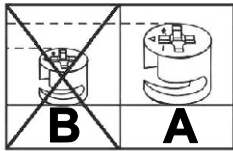
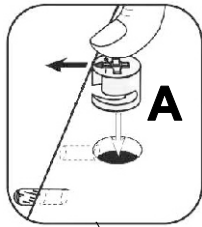

Ø15x12mm		Ø8x30mm			
					
A x4	C x2	D x4	E1 x2	E2 x2	K2 x3



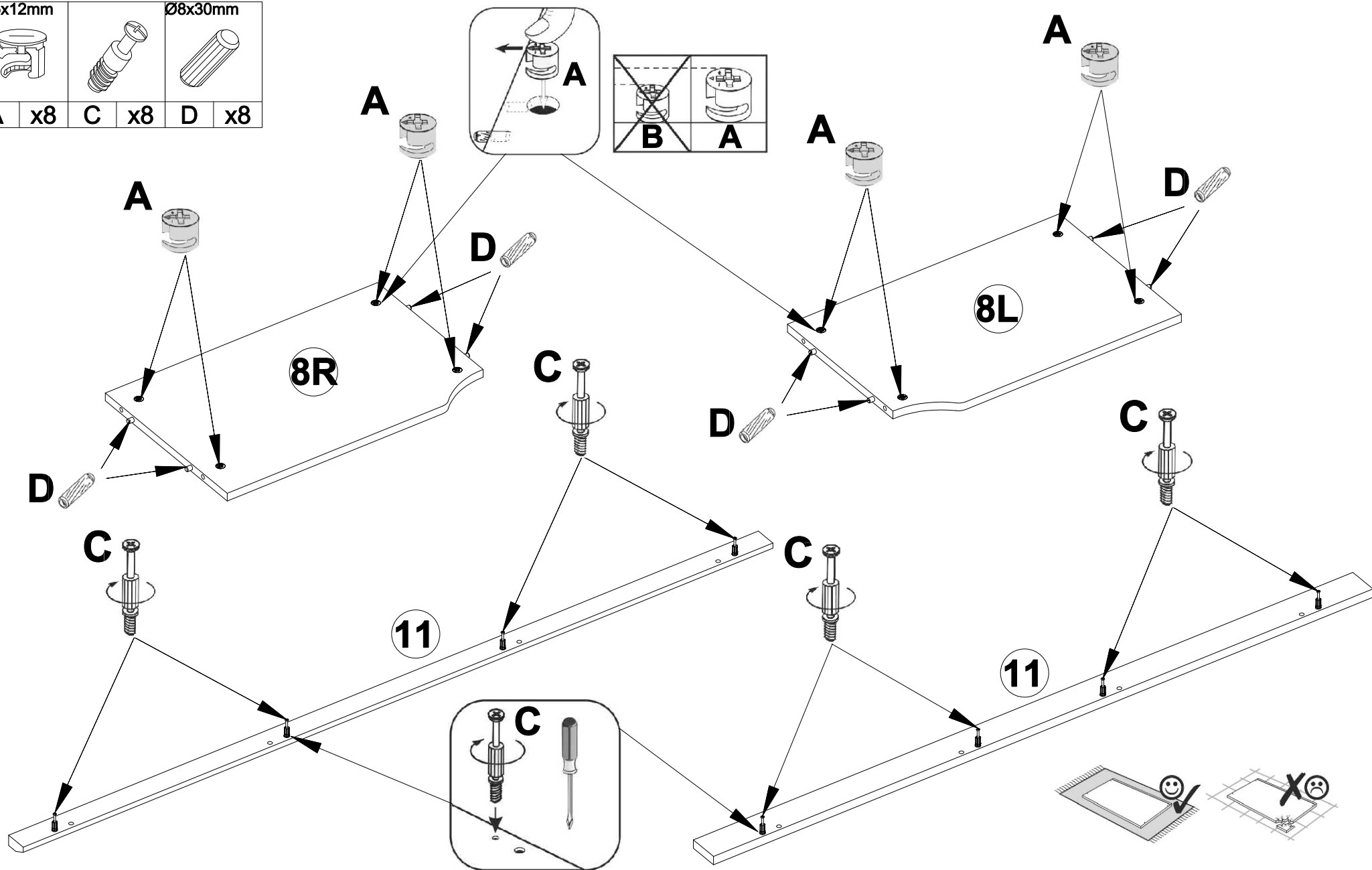

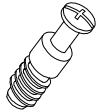
Ø15x12mm		Ø8x30mm
		
A x8	C x8	D x8



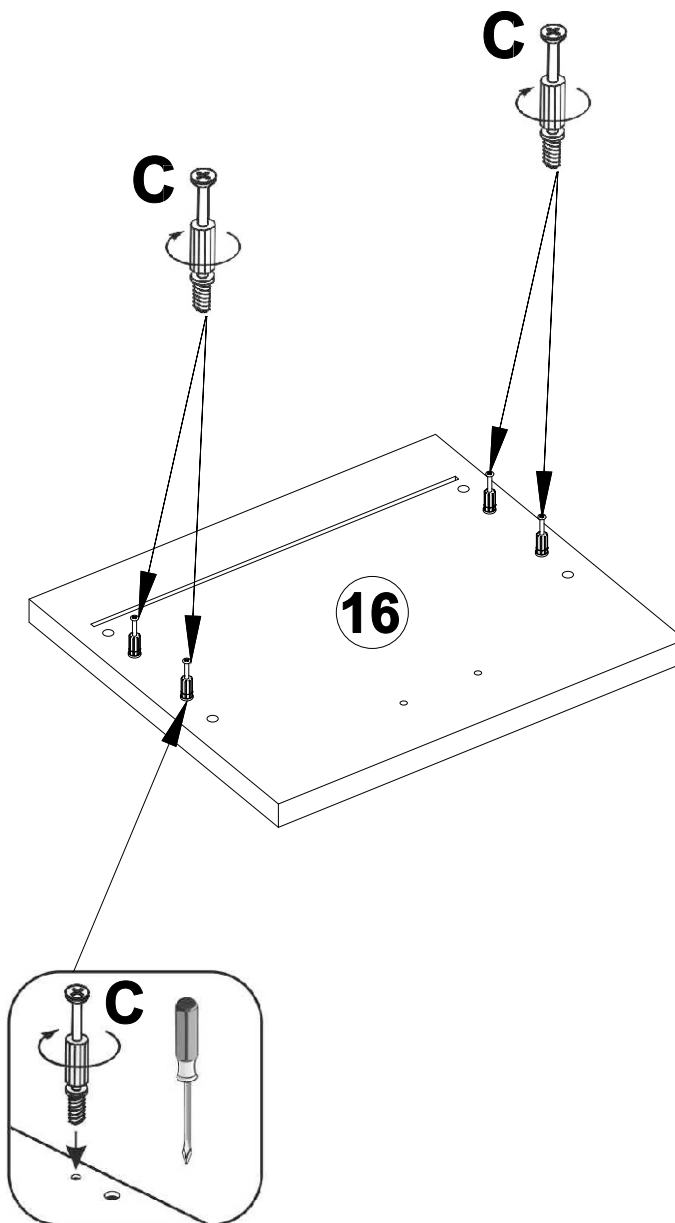
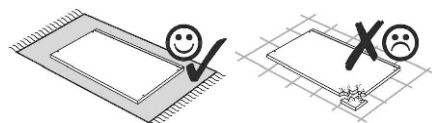
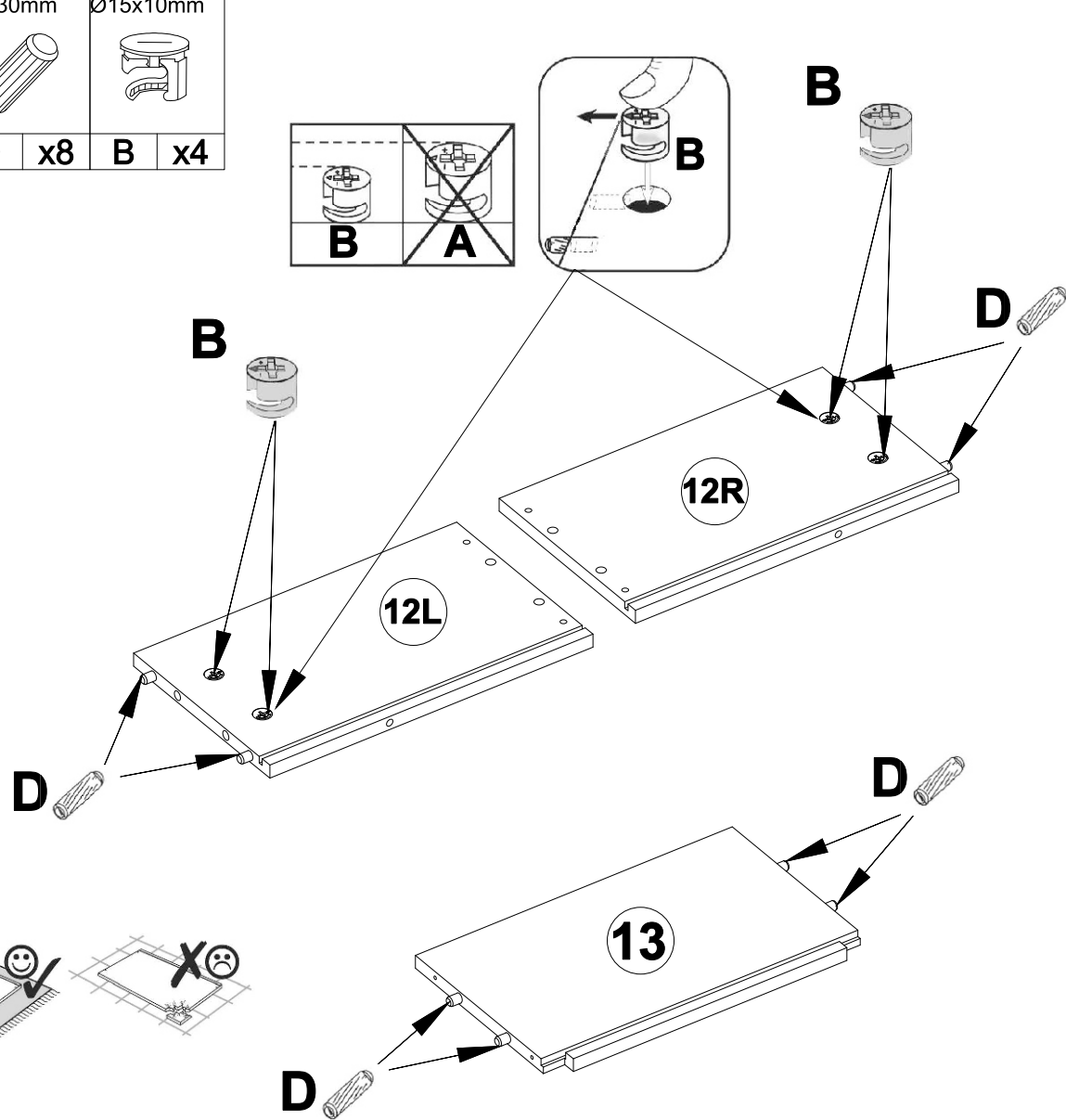
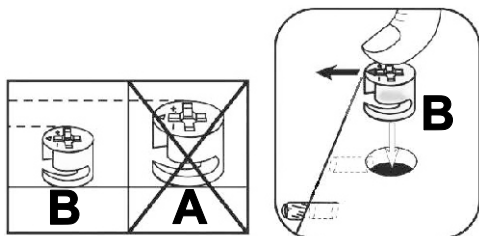

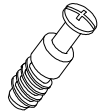
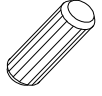
	Ø8x30mm		Ø15x10mm		
<b>C</b>	<b>x4</b>	<b>D</b>	<b>x8</b>	<b>B</b>	<b>x4</b>

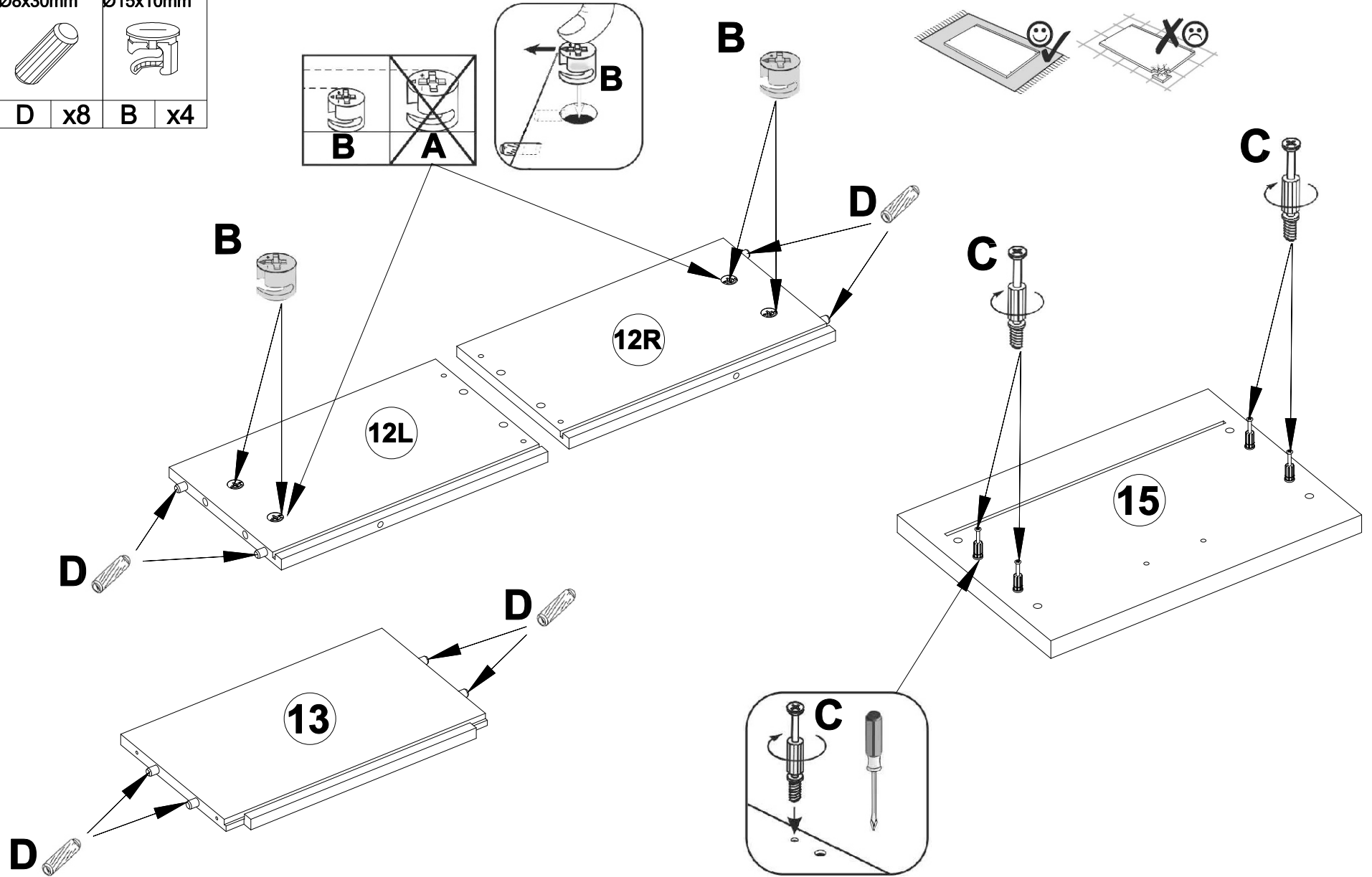

	$\varnothing 8 \times 30 \text{mm}$	$\varnothing 15 \times 10 \text{mm}$
<b>C</b>	<b>x4</b>	<b>x8</b>
		
<b>D</b>	<b>x8</b>	<b>B</b>
		<b>x4</b>

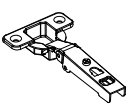

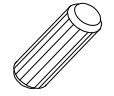
	$\varnothing 3,5 \times 13 \text{mm}$	$\varnothing 8 \times 30 \text{mm}$
		
<b>K</b> x8	<b>K1</b> x16	<b>D</b> x4

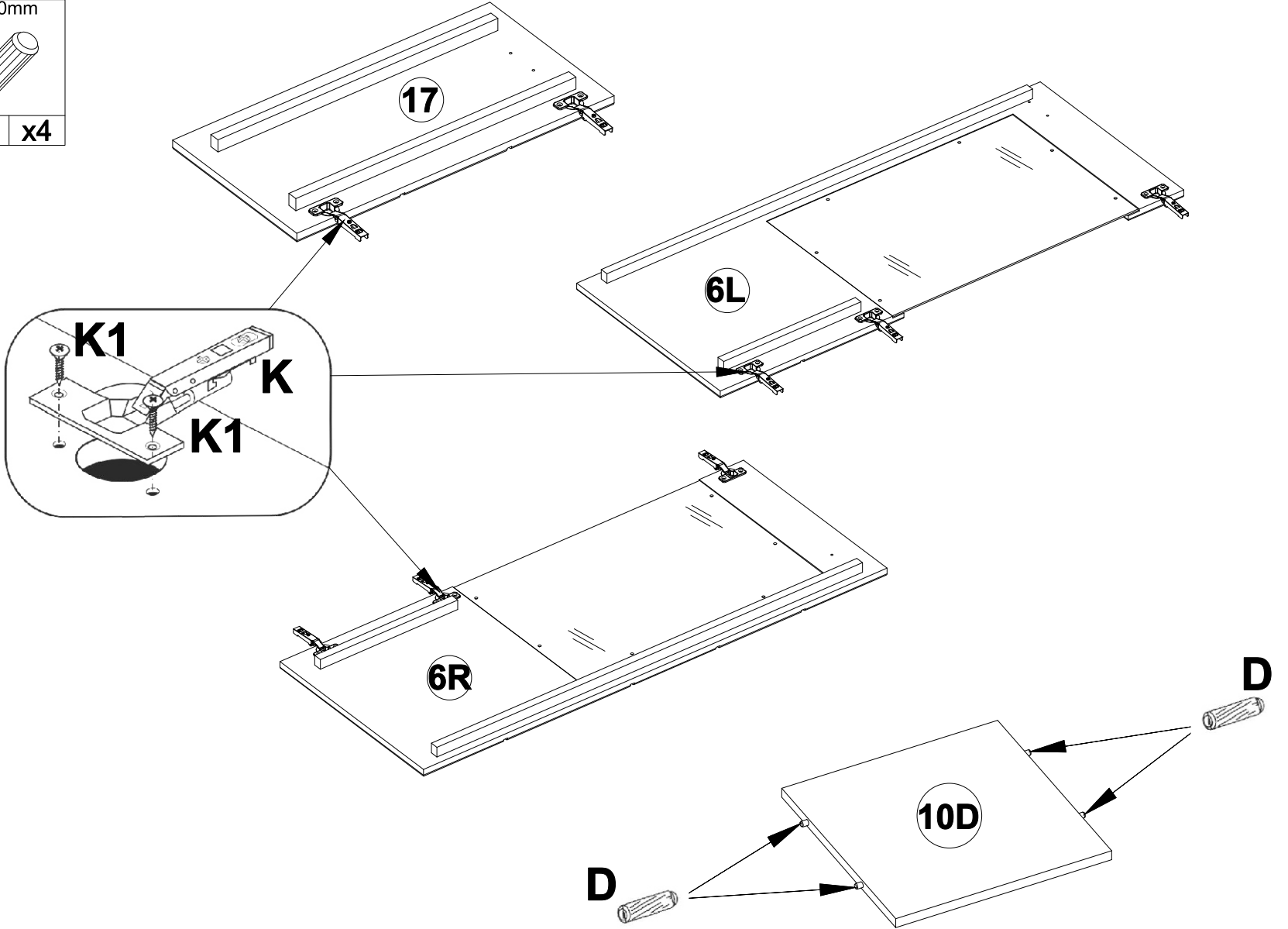

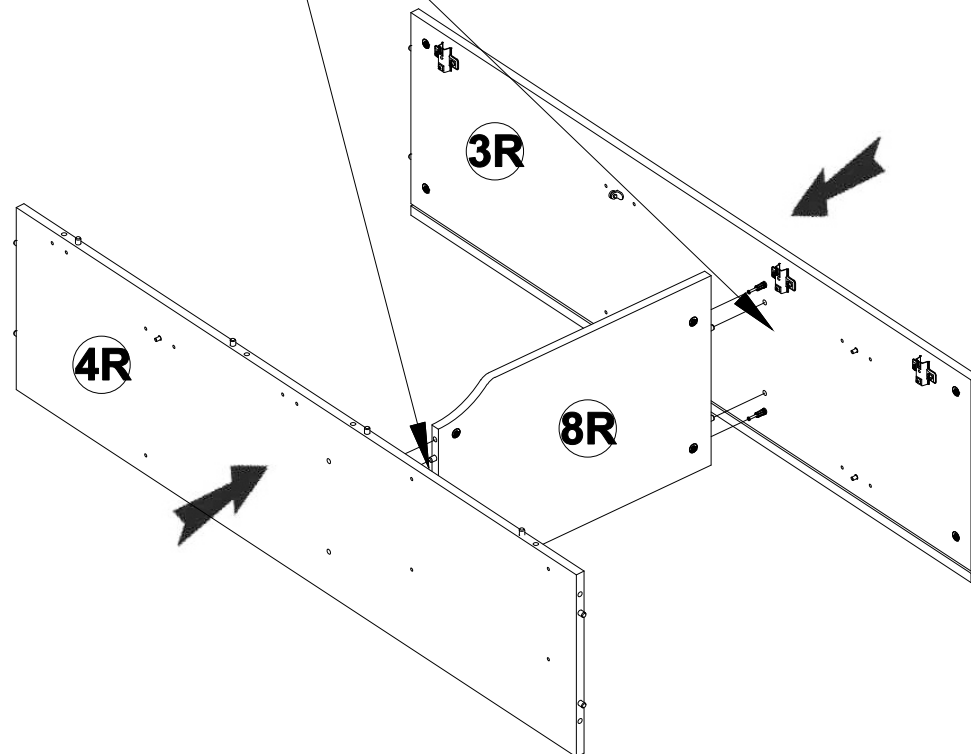
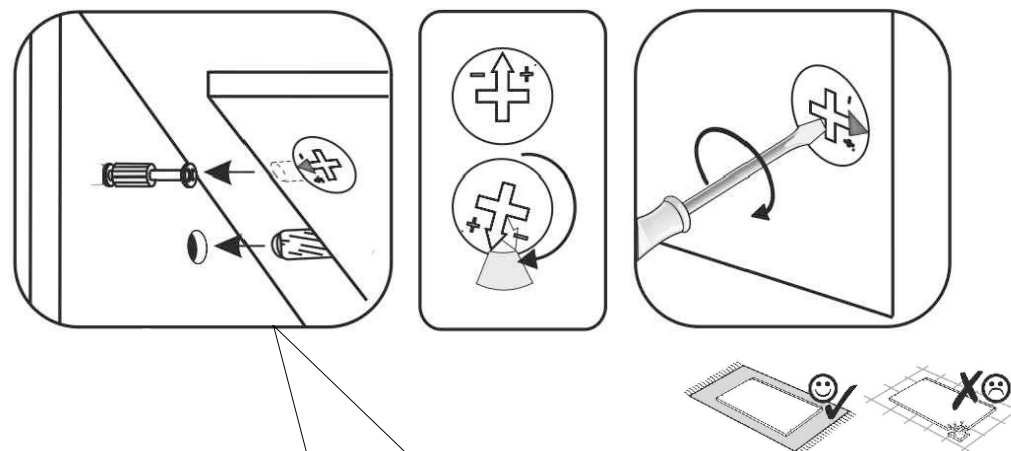
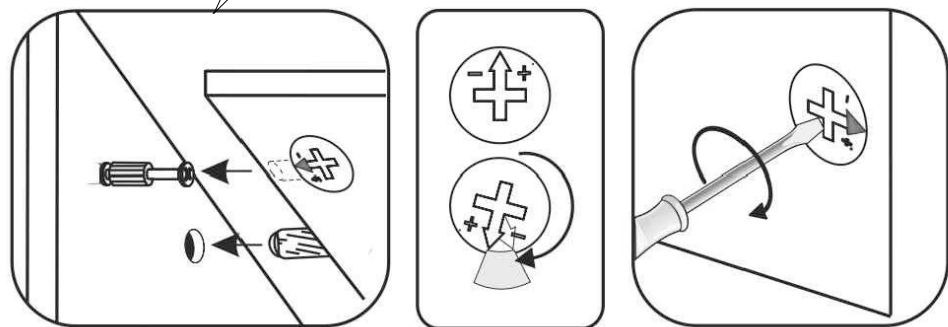
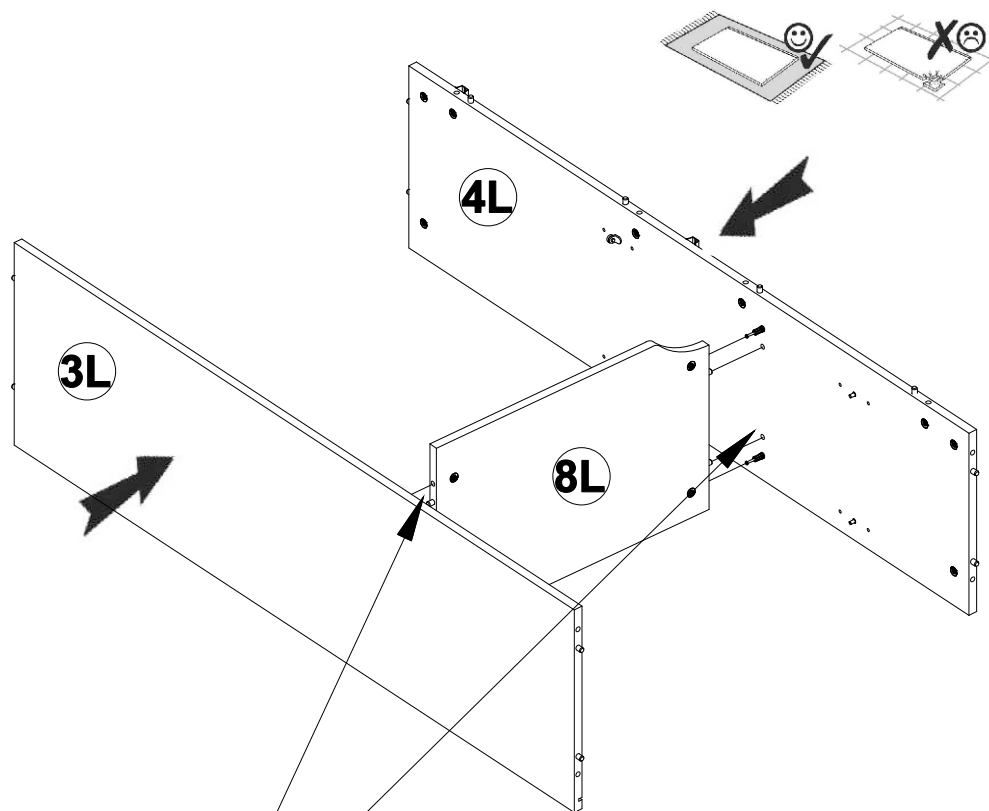

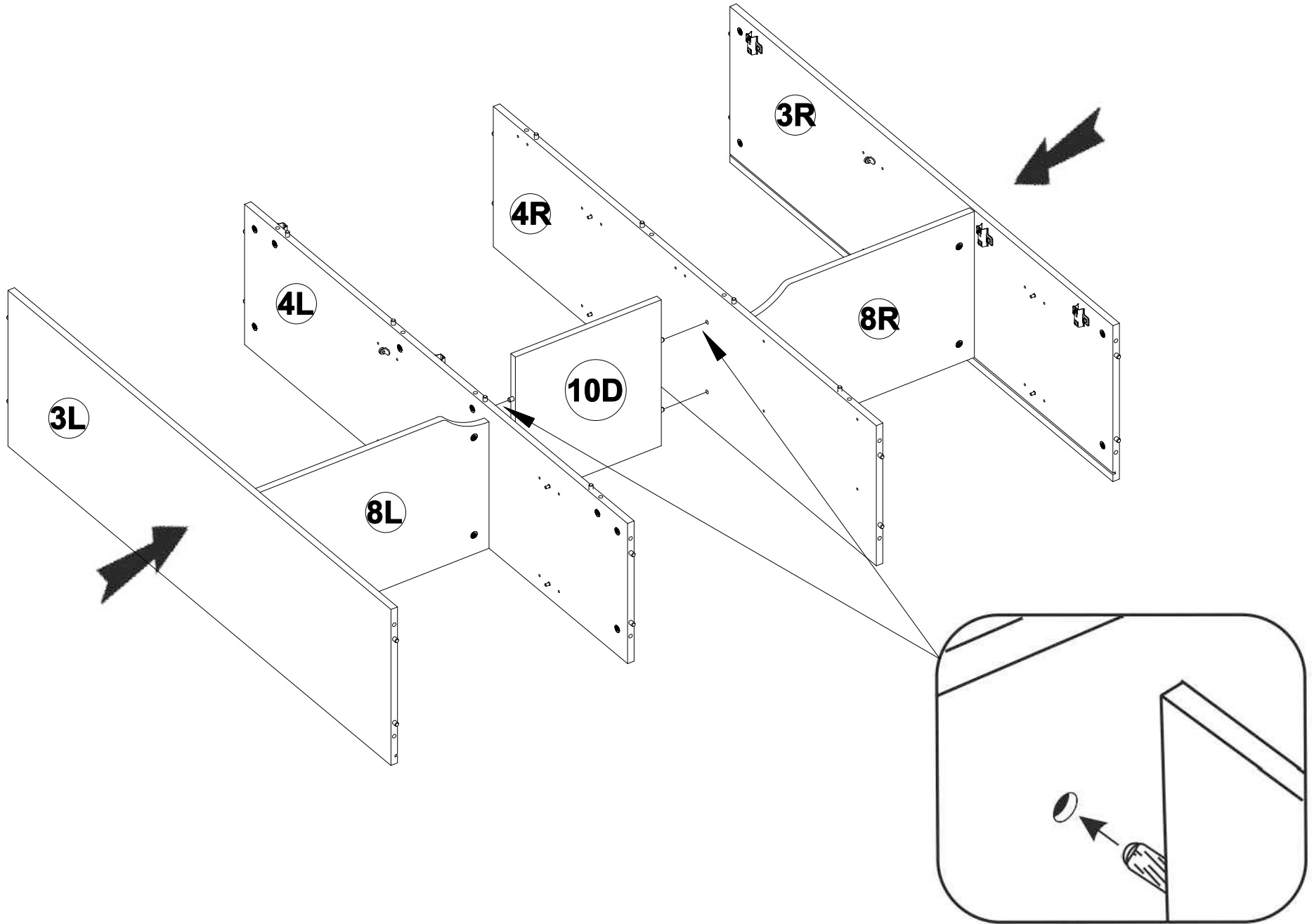

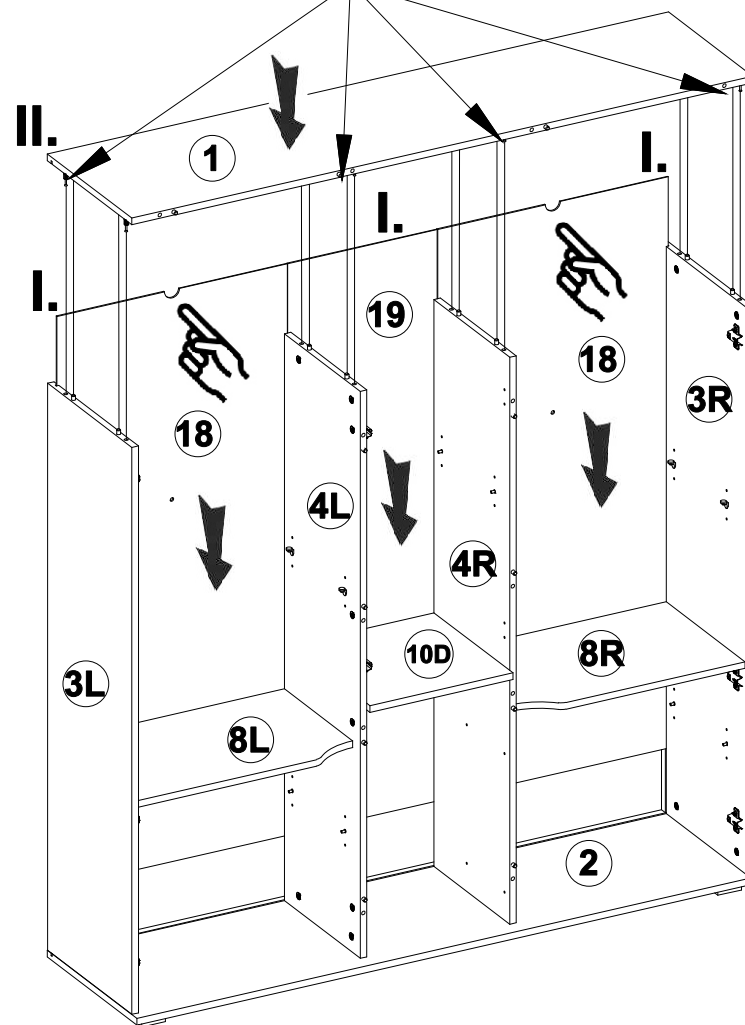
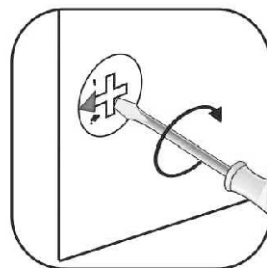
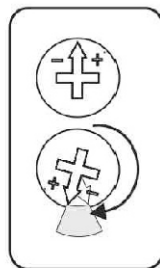
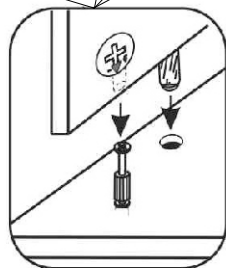
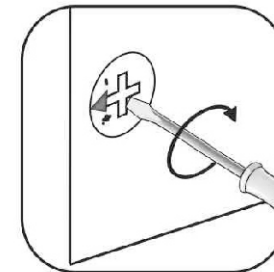
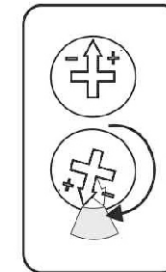
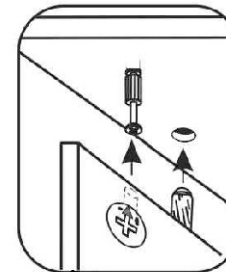
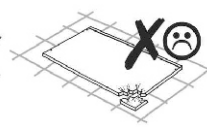
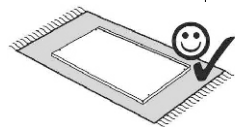
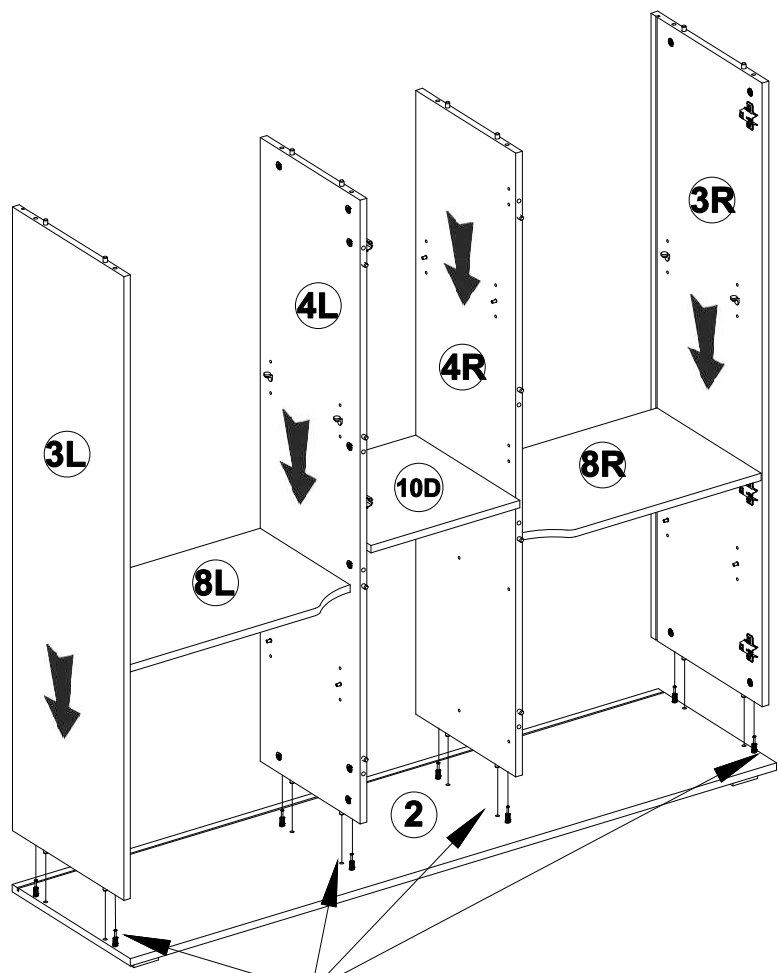

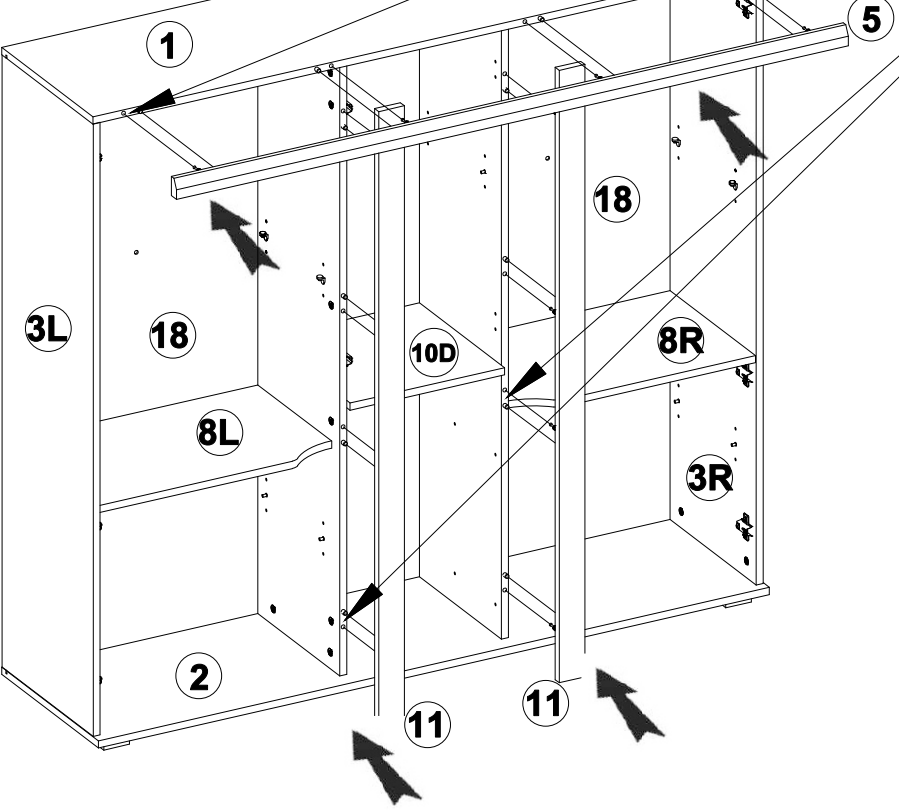
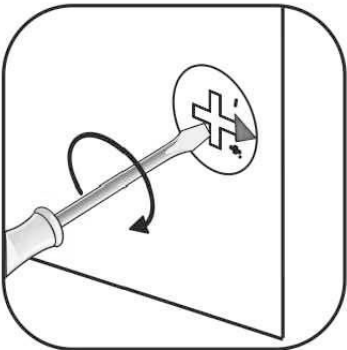
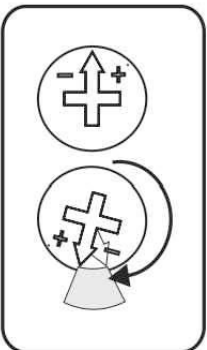
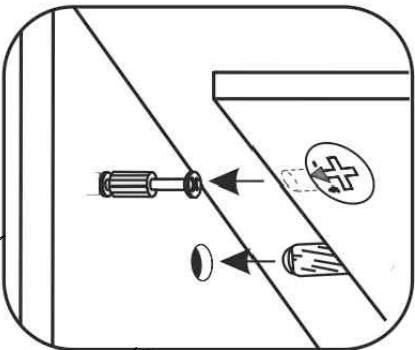
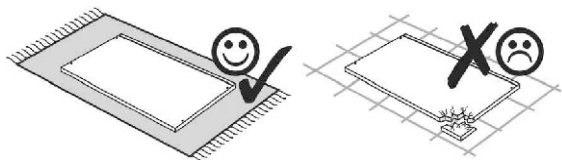

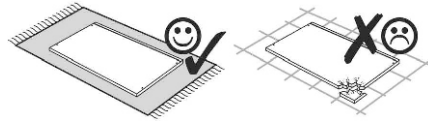



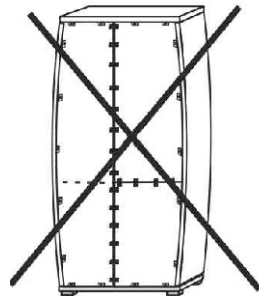
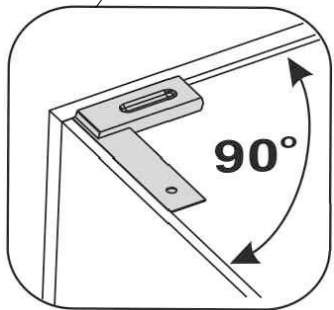
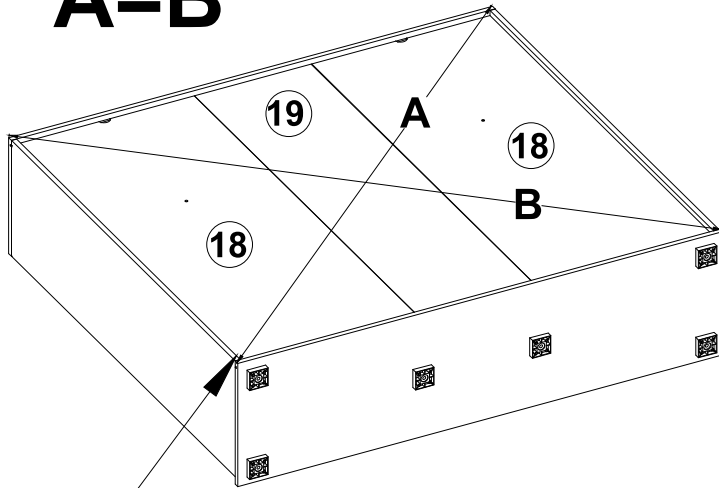

**A=B**



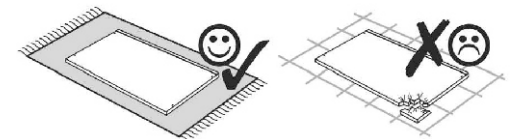
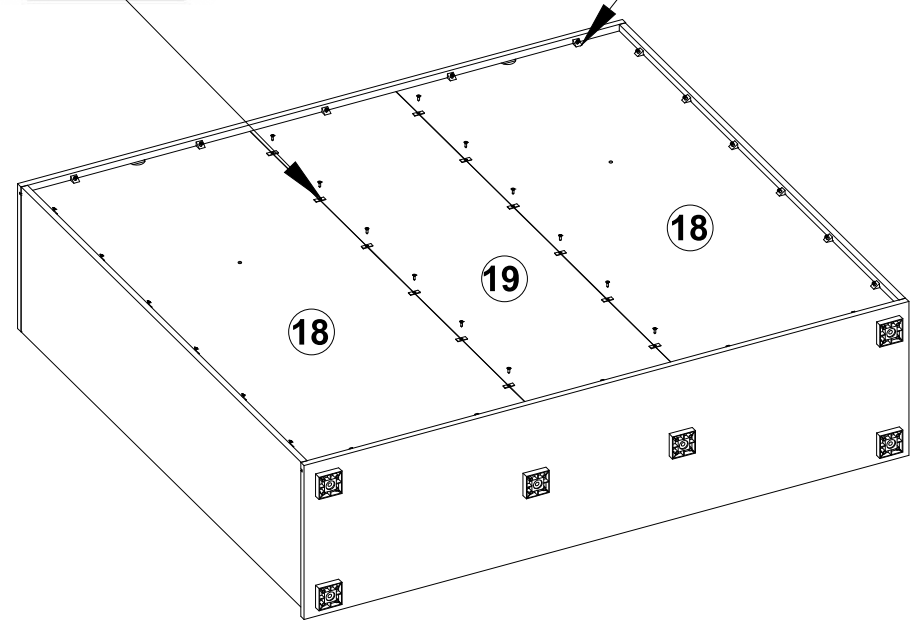
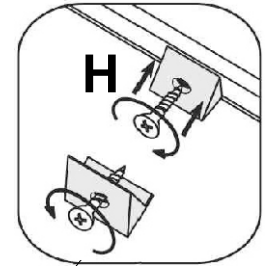
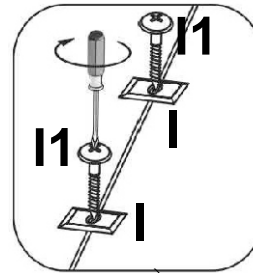

	$\varnothing 3 \times 16 \text{mm}$		
I x12	I1 x12	H x22	

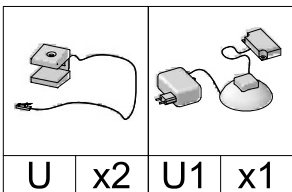



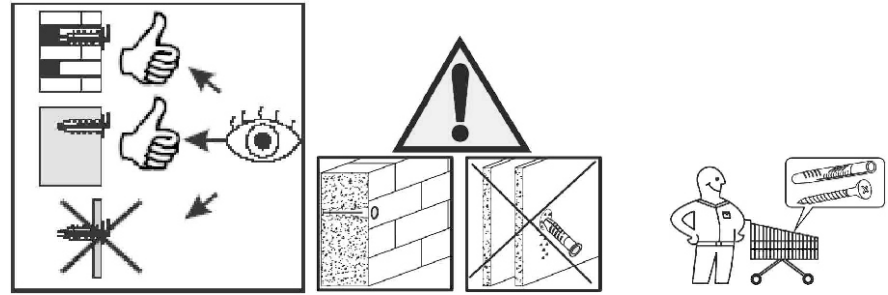
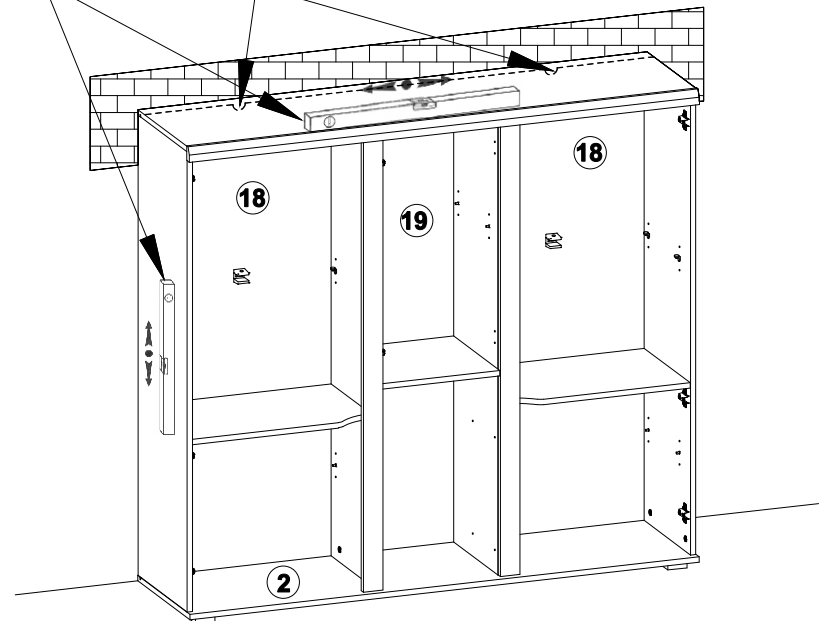
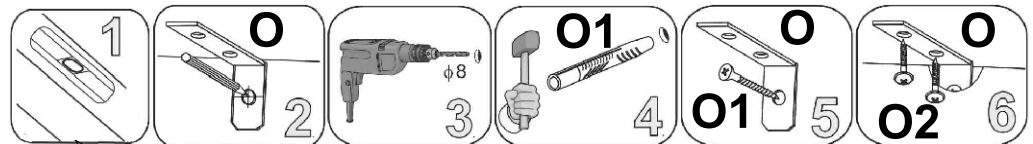
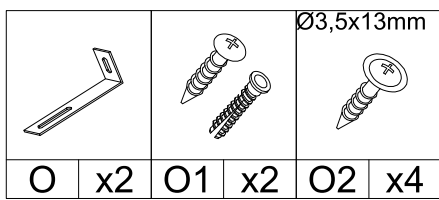
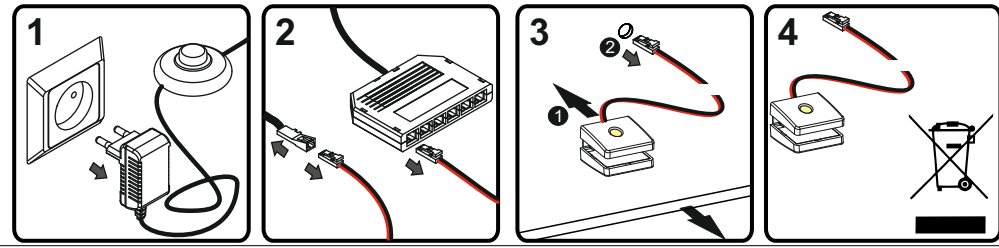
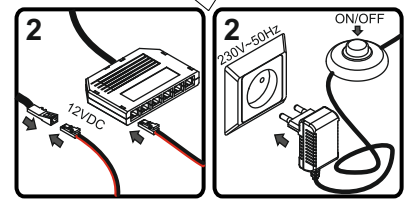
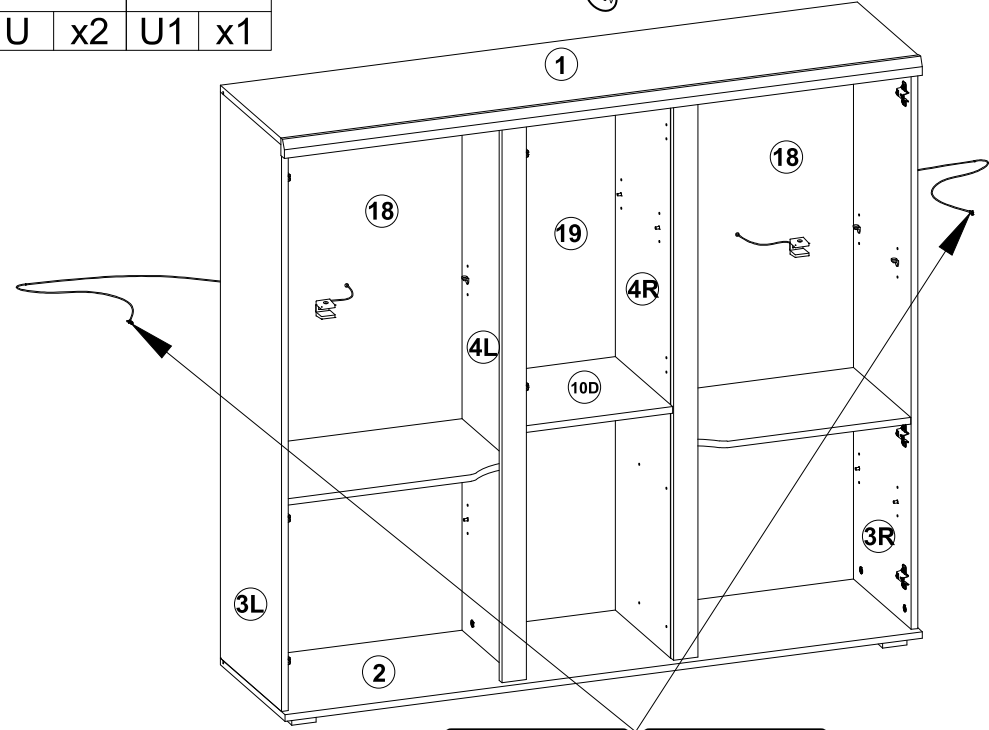
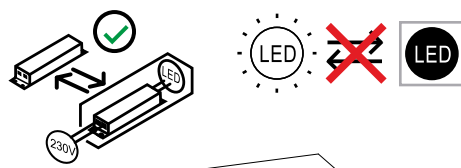

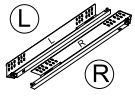
LED-osv tlení/  
osvetlenie:  
Zeta S 3S

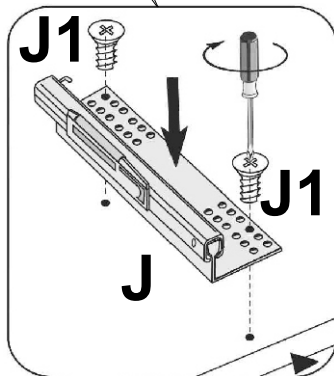
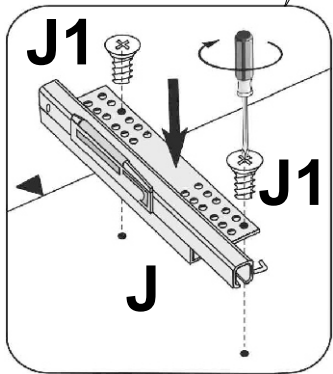
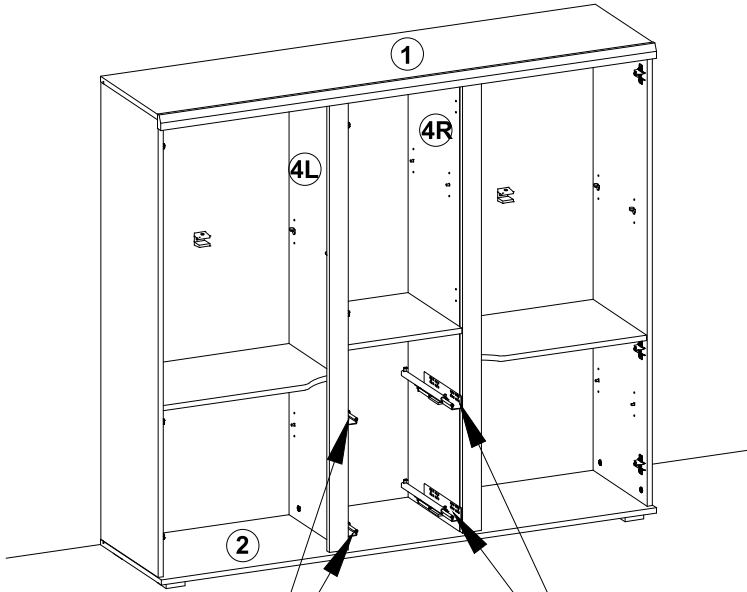

L-300mm		Ø6x11mm	
			
J	x2	J1	x8



Ø3,5x30mm			
			
F	x8	G1	x8

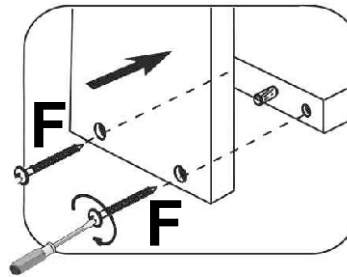

x2

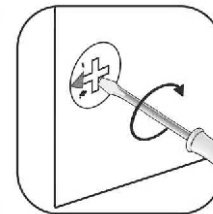
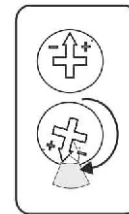
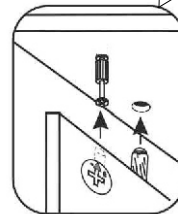
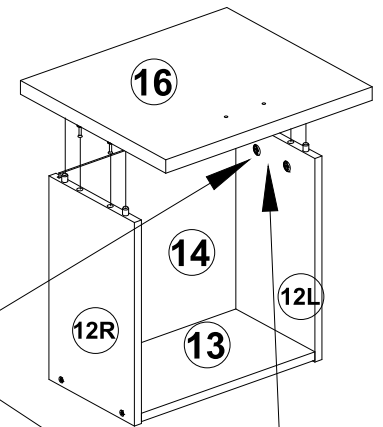
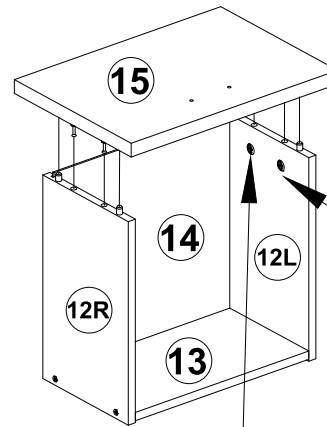
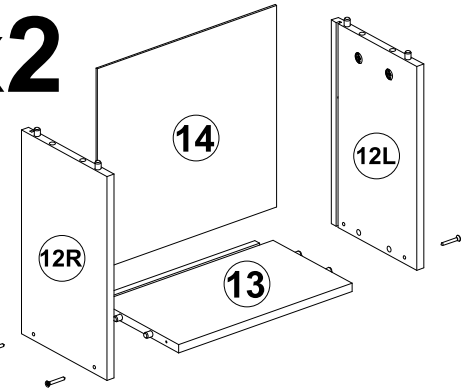

Ø3,5x13mm



J2 x8

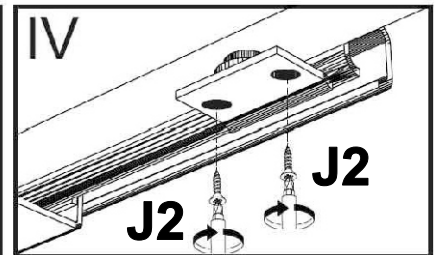
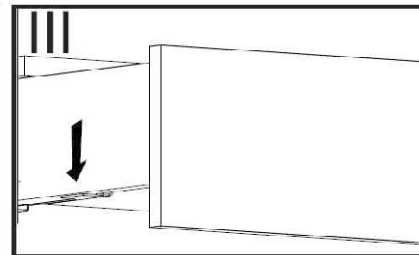
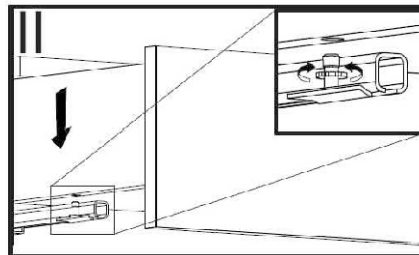
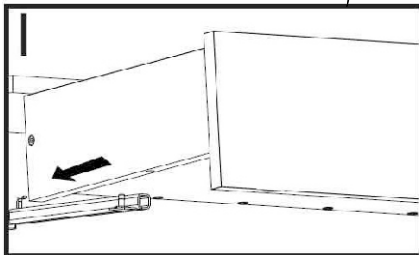
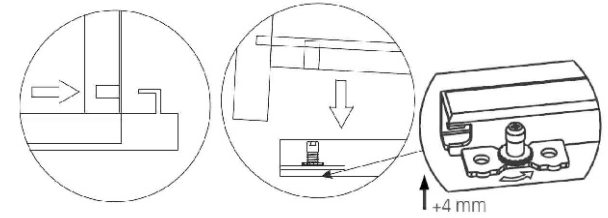
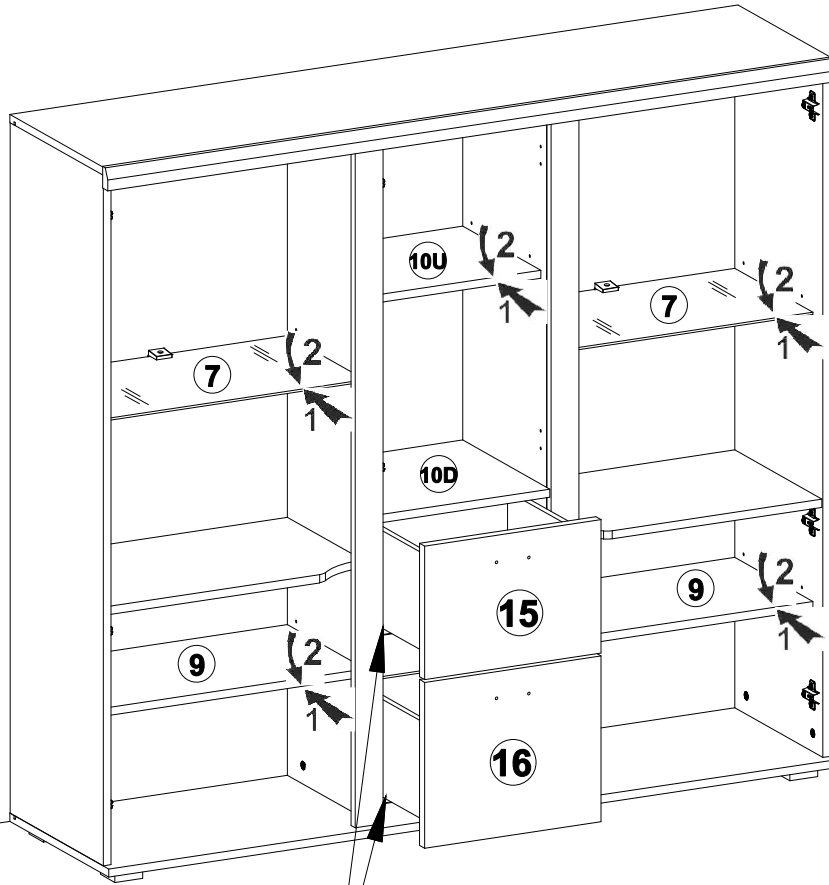

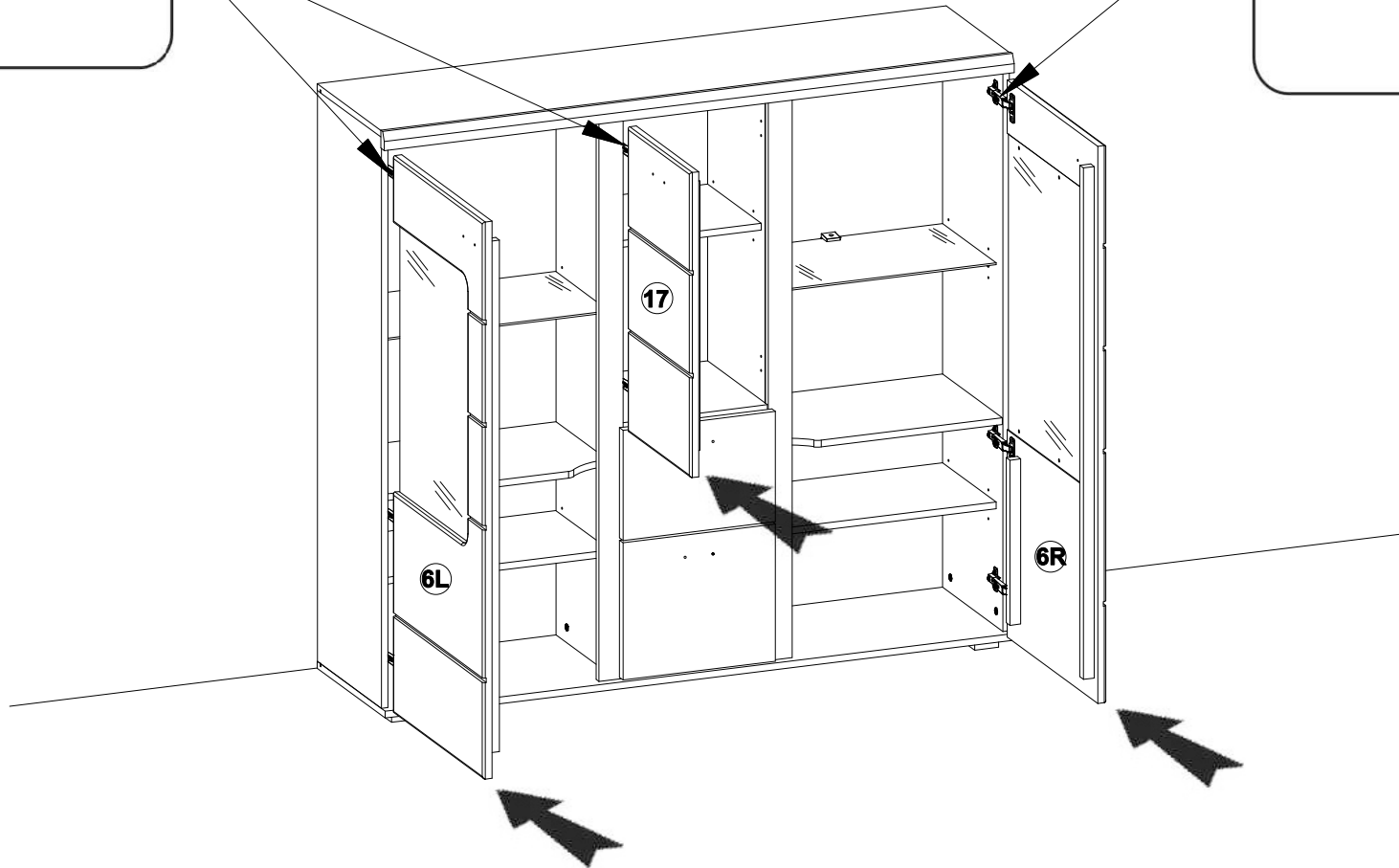

L-80mm		M4x25mm					
L	x5	L1	x10	P	x2	G	x36

