

1

2

3

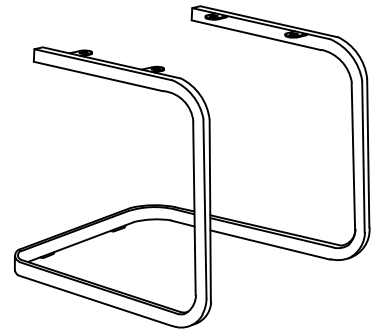
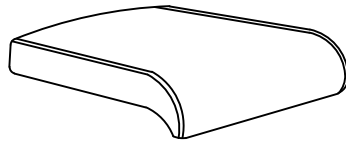
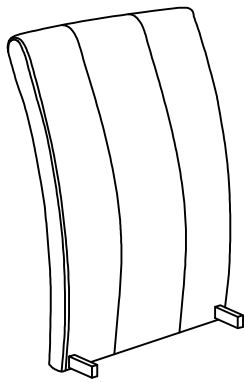

1	1x
2	1x
3	1x

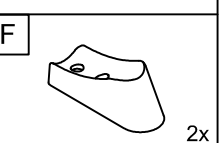
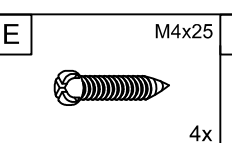
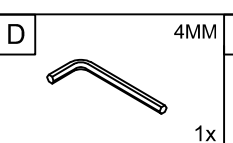
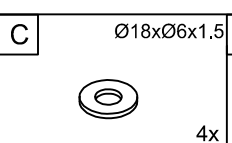
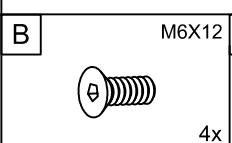
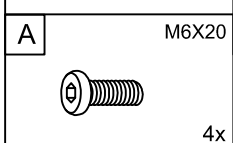
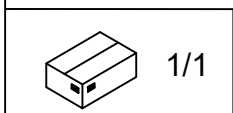

I.

1

E M4x25
4x

F
2x

100%

2

B M6x12
4x

D 4MM
1x

75%

3

A M6x20
4x

C Ø18xØ6x1.5
4x

D 4MM
1x

75%

4

D 4MM
1x

100%



Séparez les éléments avant de trier