

1

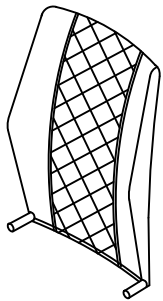

2

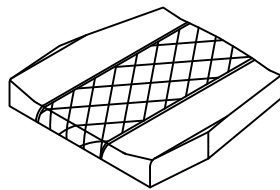

3

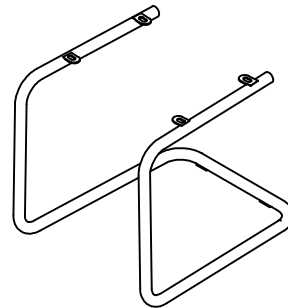

| | |
|---|----|
| 1 | 1X |
| 2 | 1X |
| 3 | 1X |



1/1

A

M6*12

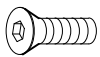

4X

B

M6*18



4X

C

Ø18*Ø6.5*1.5



4X

D

M4*20

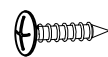

4X

E



2X

F

4mm



1X

I.

1.

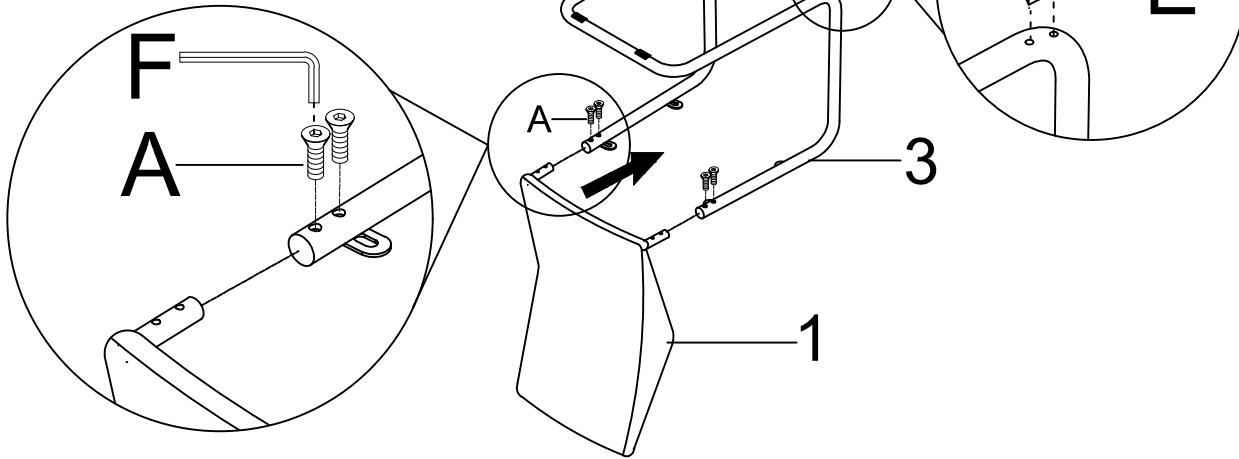

- A M6*12 4X
 - D M4*20 4X
 - E 2X
 - F 4mm 1X
- 75%

2.

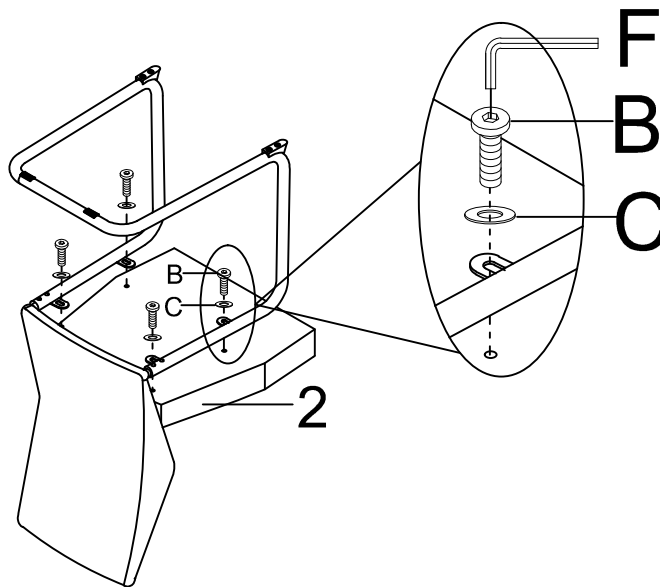

- B M6*18 4X
 - C Ø18*Ø6.5*1.5 4X
 - F 4mm 1X
- 75%

3.

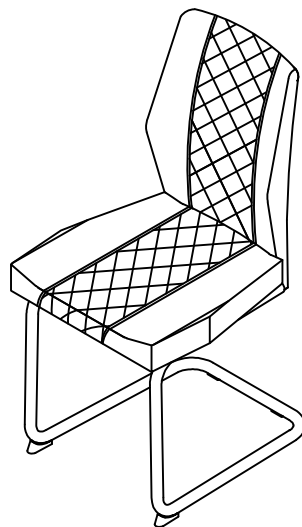

- F 4mm 1X
- 100%



Séparez les éléments avant de trier