

1

2

3

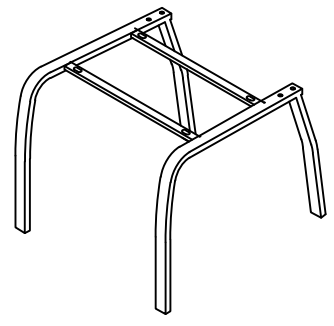

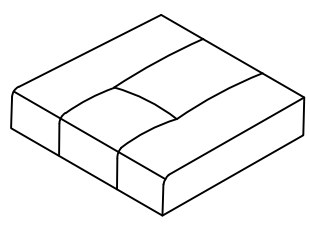
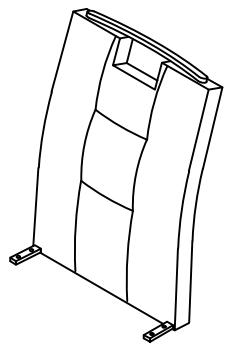

1	1X
2	1X
3	1X

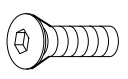

1/1

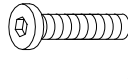
<b>A</b>	M6*12
	4X

<b>B</b>	M6*32
	4X

<b>C</b>	Ø20*Ø6.5*1.5
	4X

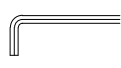
<b>D</b>	4mm
	1X

I.

1.

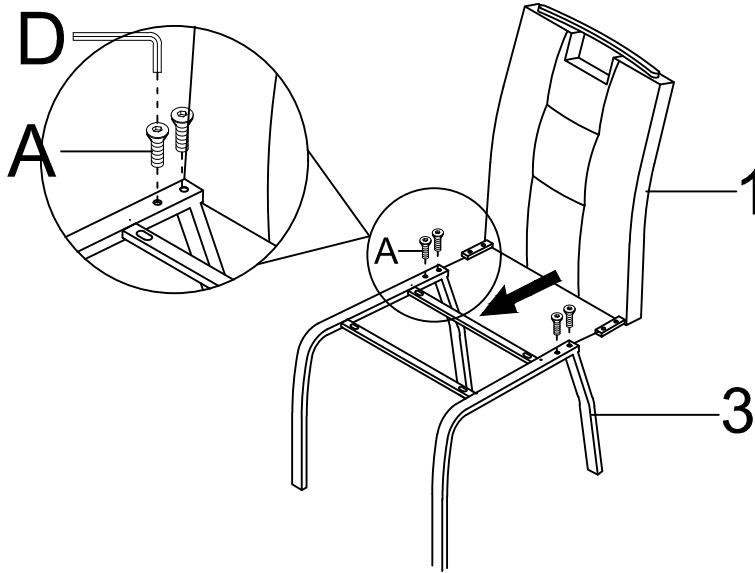

A

M6\*12

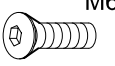

4X

D

4mm



1X

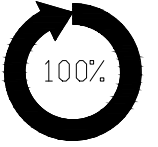

2.

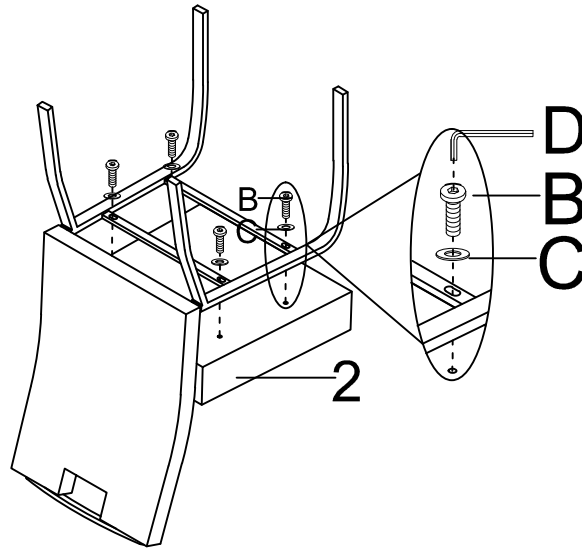

B

M6\*32

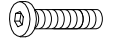

4X

C

Ø20\*Ø6.5\*1.5



4X

D

4mm



1X

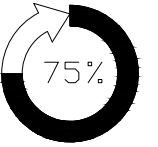

3.

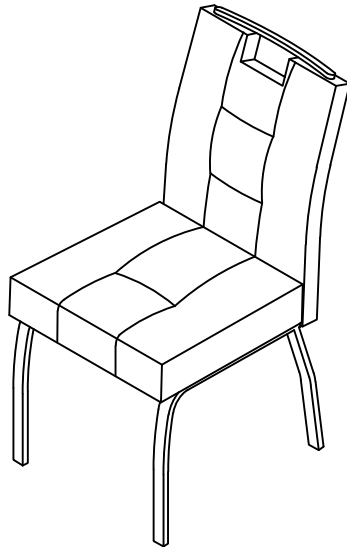

D

4mm



1X

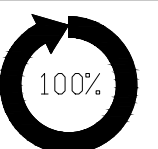

LE TRI  
+ FACILE



Séparez les éléments avant de trier