

MONTÁŽNÍ/MONTÁŽNY NÁVOD

DERRY

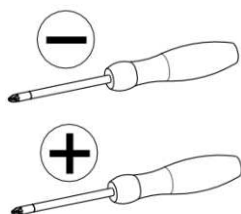

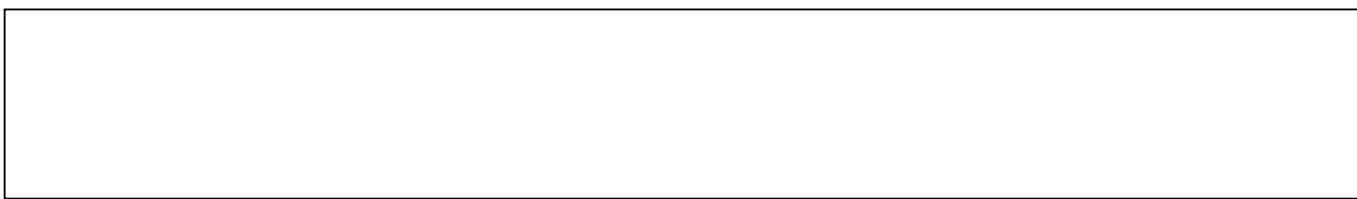

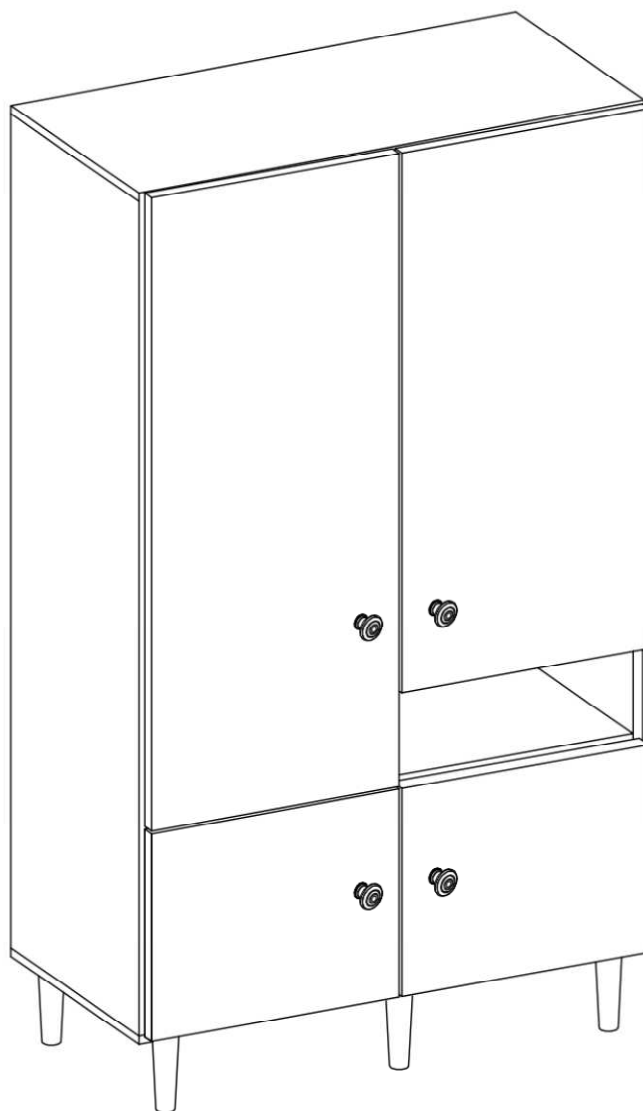
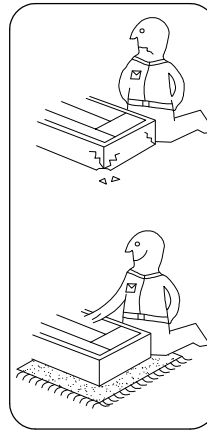
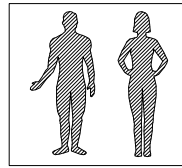
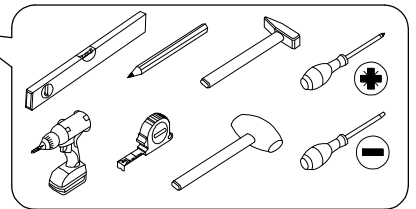
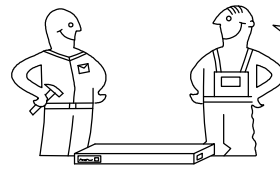
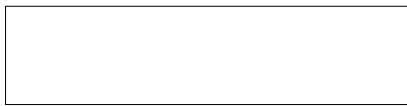

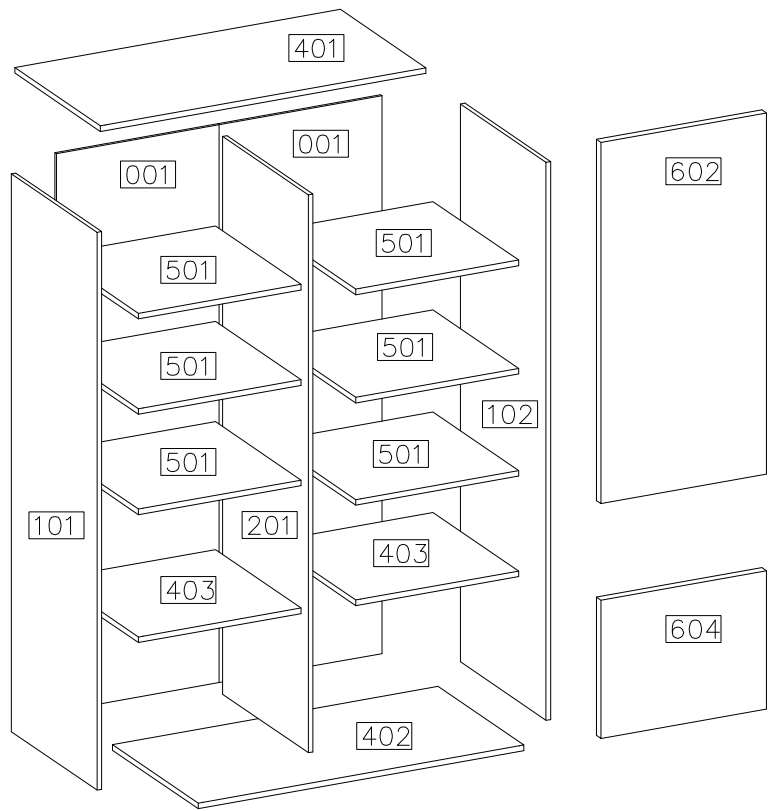
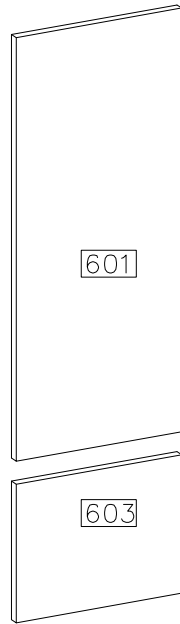
#	art.č.	počet
1	401	1
2	402	1
3	403	2
4	101	1
5	102	1
6	201	1
7	501	6
8	601	1
9	602	1
10	603	1
11	604	1
12	001	2

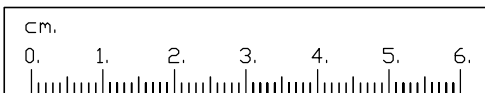

$\varnothing 8 \times 30 \text{mm}$ A	$\varnothing 8 \times 40 \text{mm}$ A1	L-65 D4	$\varnothing 15/12 \text{mm}$ C	 D1	 E	$\varnothing 3.5 \times 16 \text{mm}$ P3	 F4	M4.0x22mm R3	 S1
16	2	2	20	16	20	38	6	4	4
 F10	H=0 H4	$\varnothing 35 / \text{KR}-0$ G6	4.5x16mm P4	 J4	 L	 F8			
20	10	10	20	24	12	10			







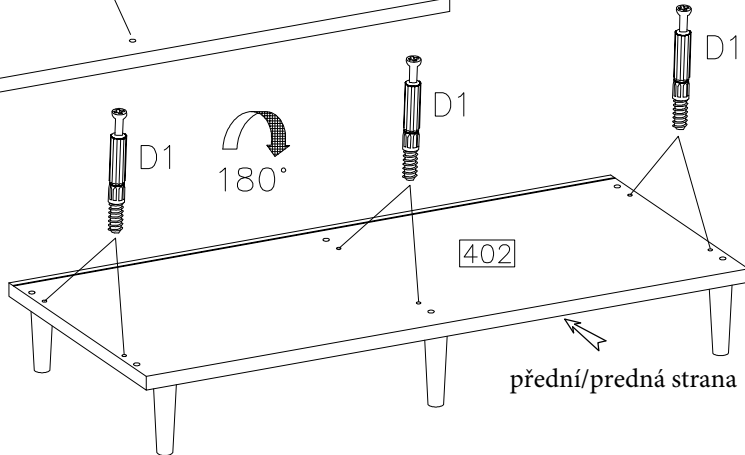
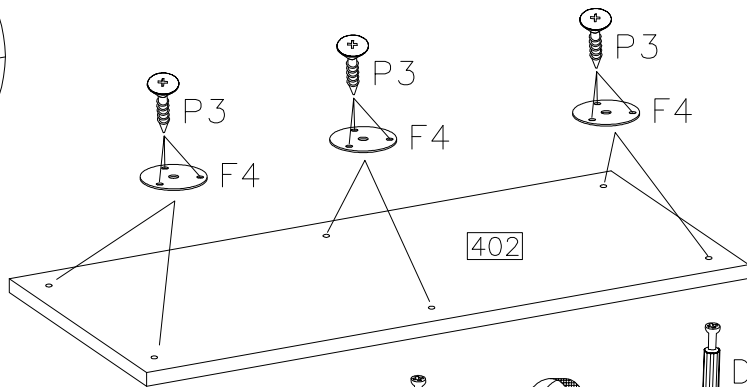
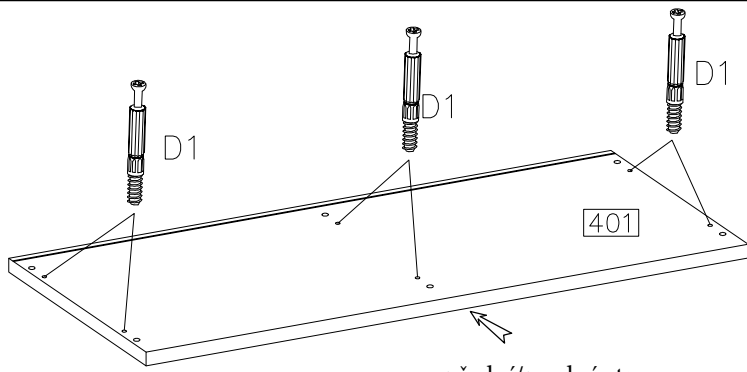
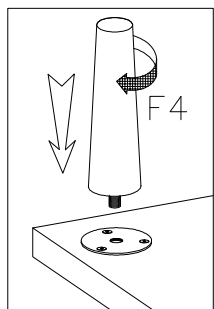
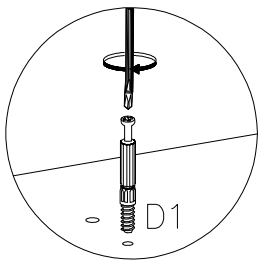

1

	$\varnothing 3.5 \times 16 \text{ mm}$	
D1	P3	F4
12	18	6



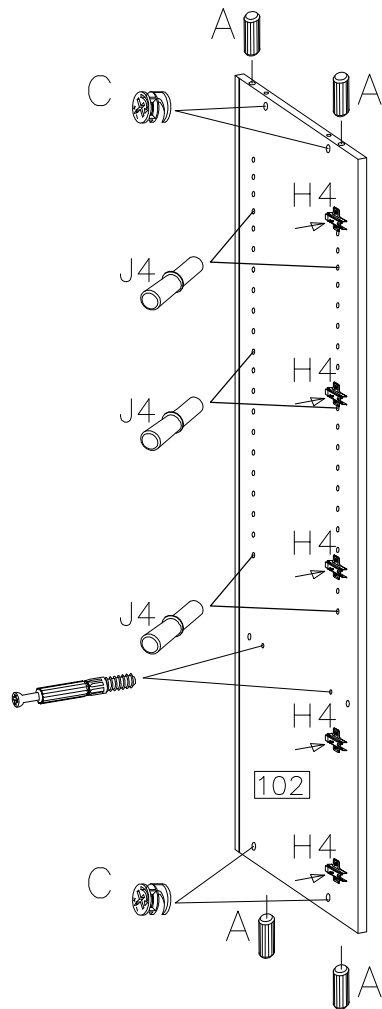
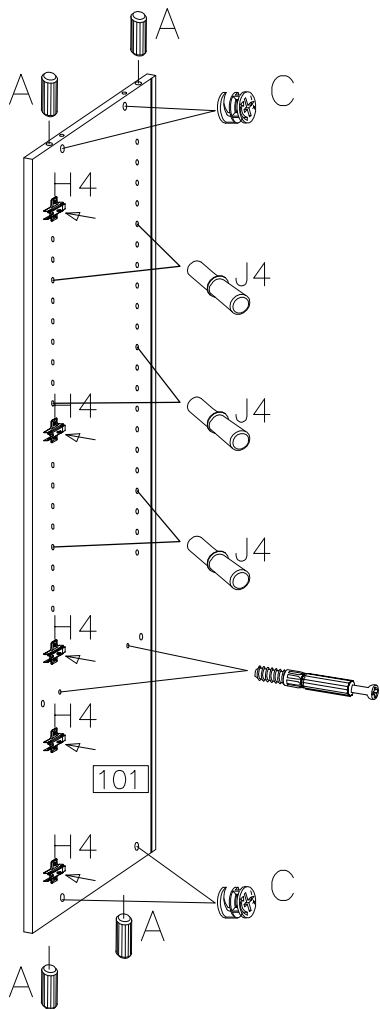
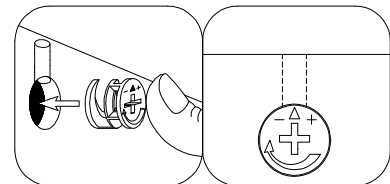
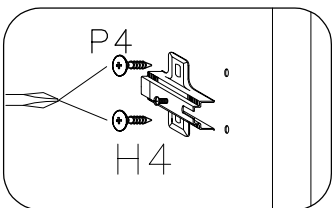

2

$\varnothing 15/12$	$\varnothing 8 \times 30$
	
C	A
8	8
	
D1	J4
4	12
H=0	4.5x16mm
	
H4	P4
10	20



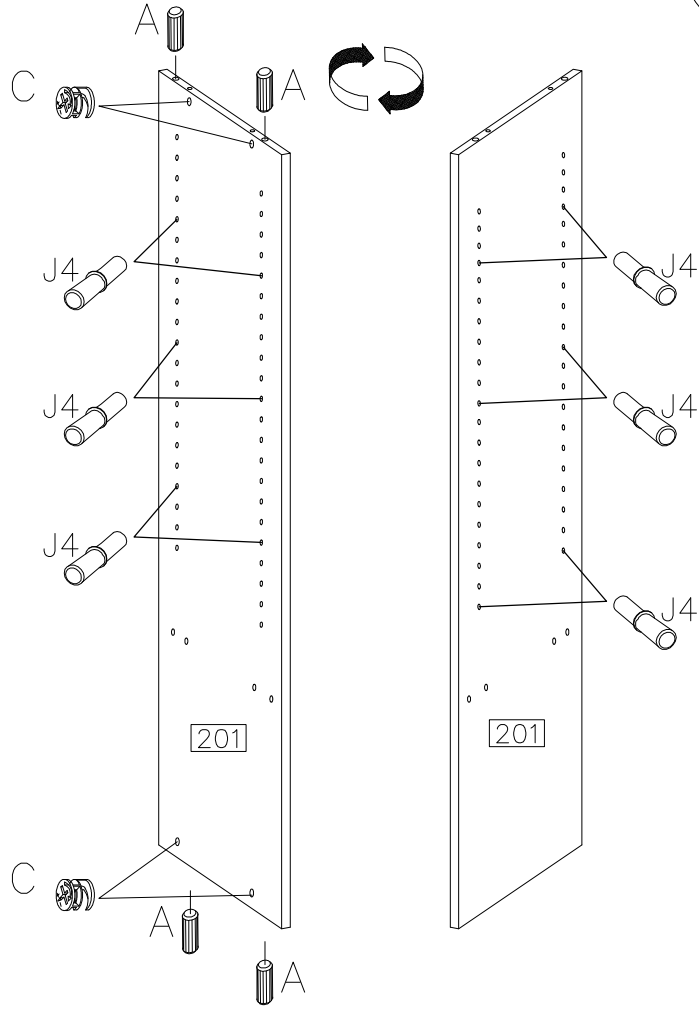
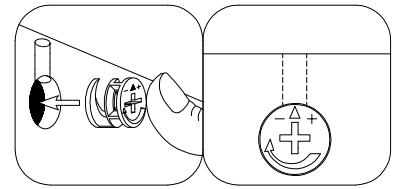

3

$\varnothing 15/12$  C 4	$\varnothing 8 \times 30$  A 4
 J4 12	





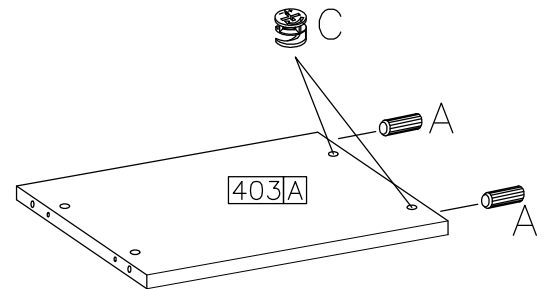
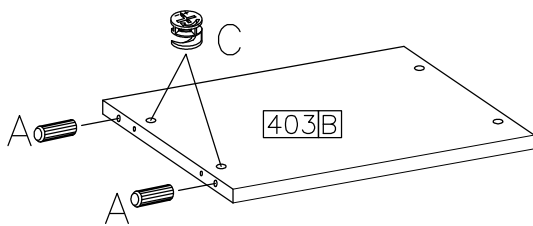
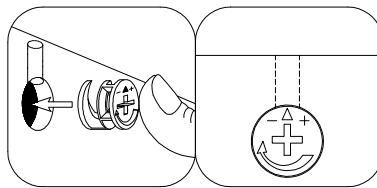

4

$\varnothing 15/12$  C 4	$\varnothing 8 \times 30$  A 4
--	--



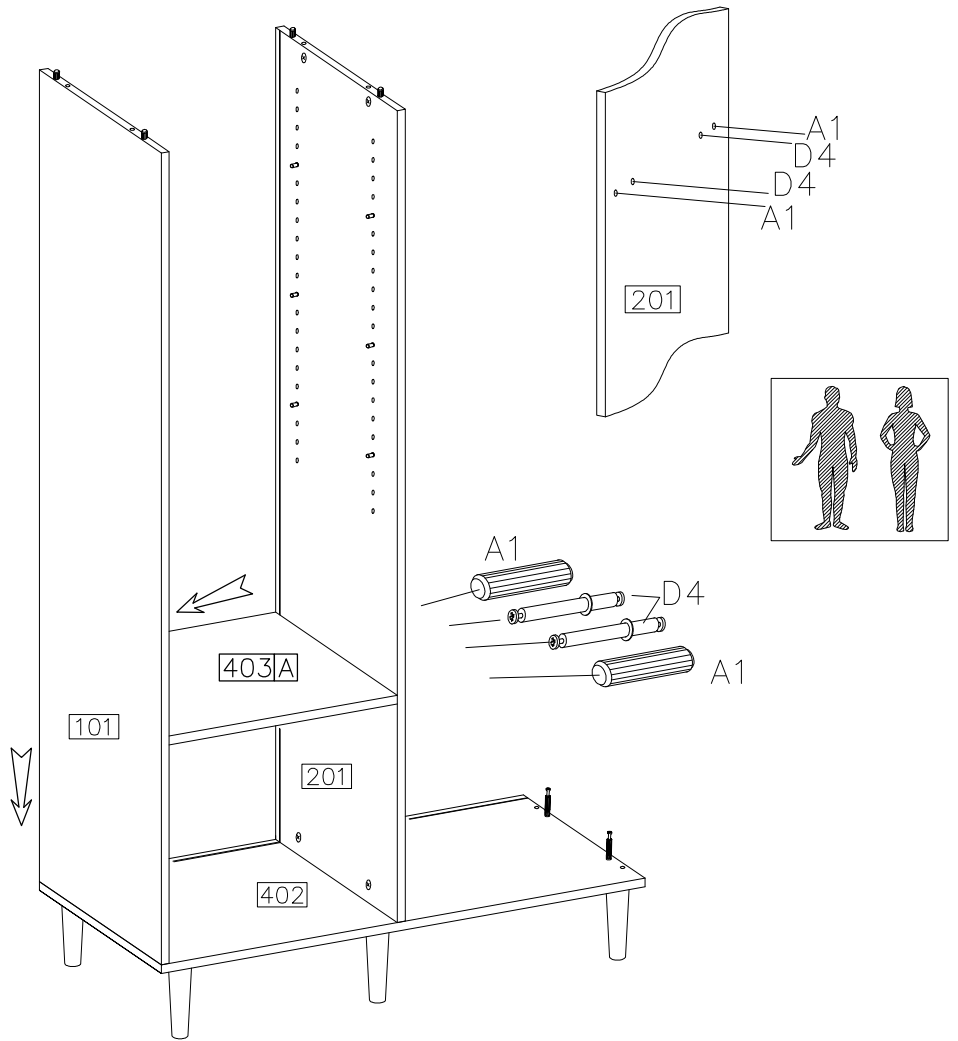
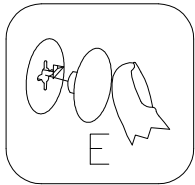
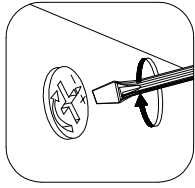

5

 E	 C
6	6
$\varnothing 8 \times 40 \text{mm}$	L-65
 A1	 D4
2	2

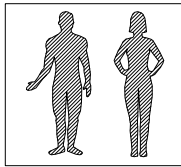

6



 E
6
$\varnothing 15/12$
 C
4

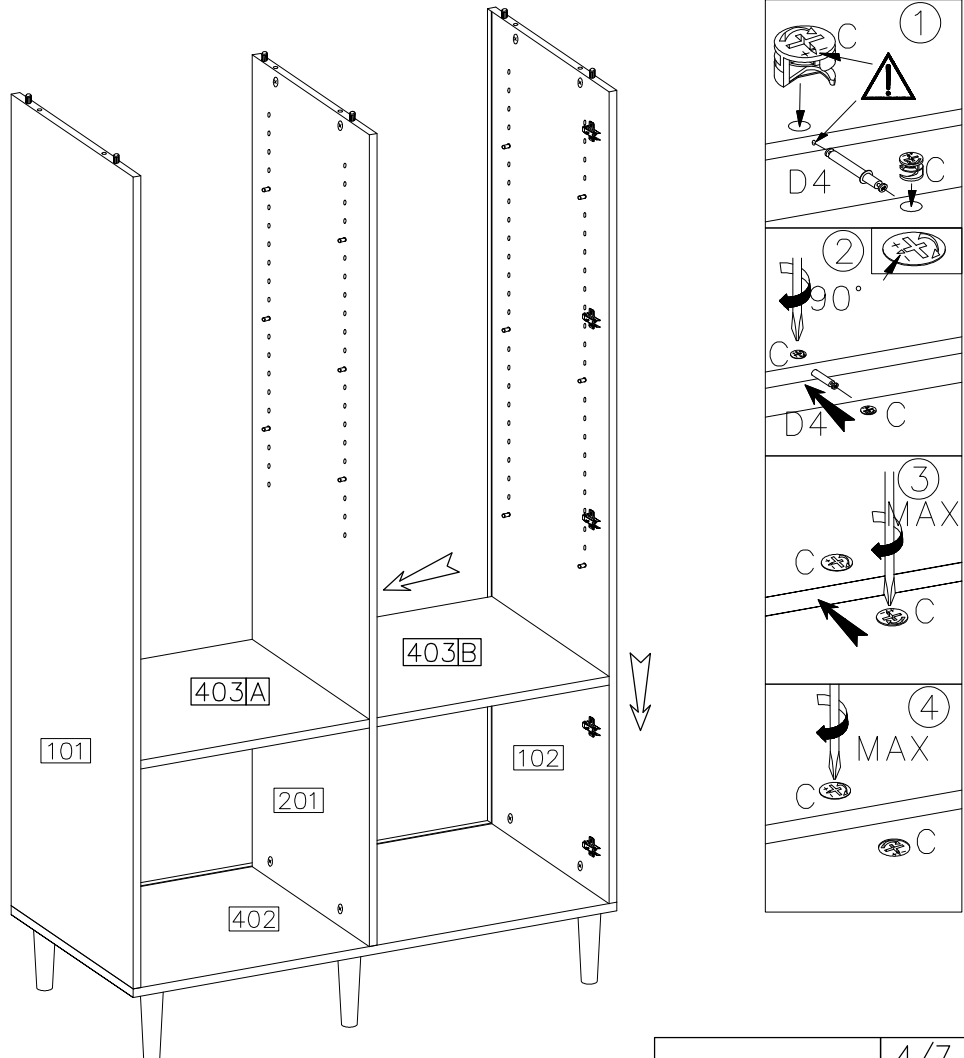
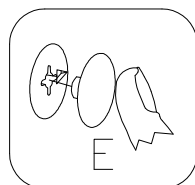
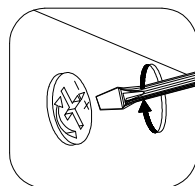

7

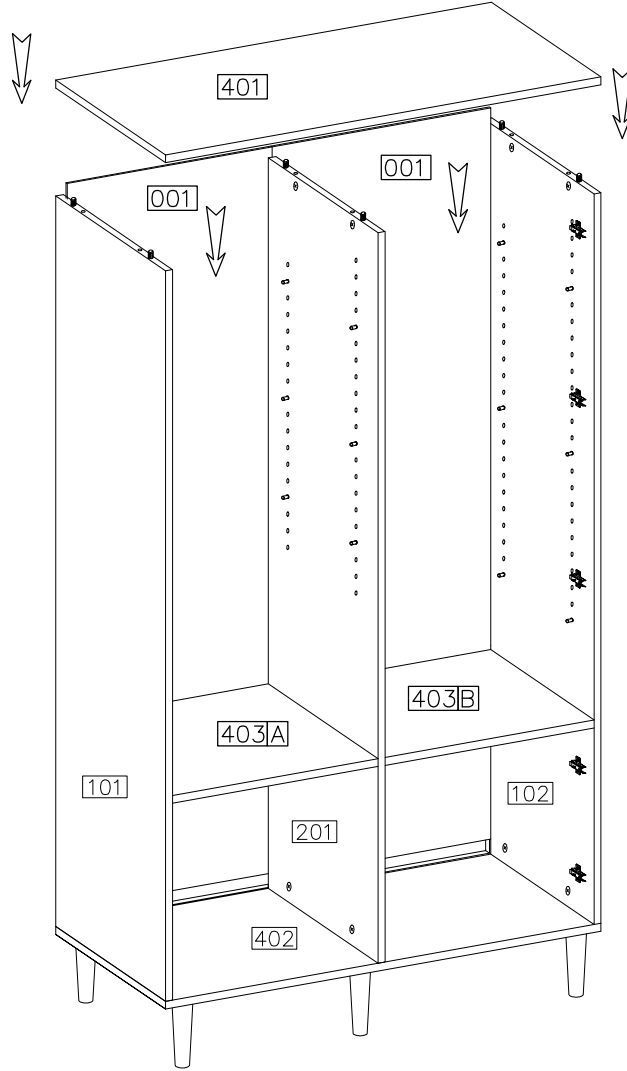
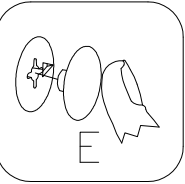
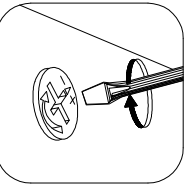
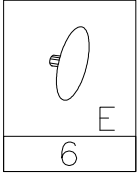

8

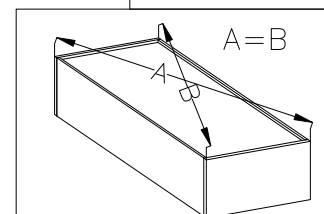
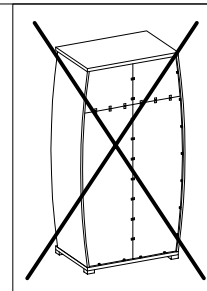
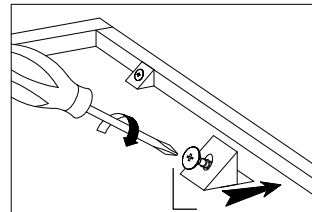
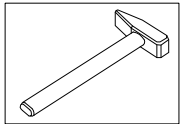
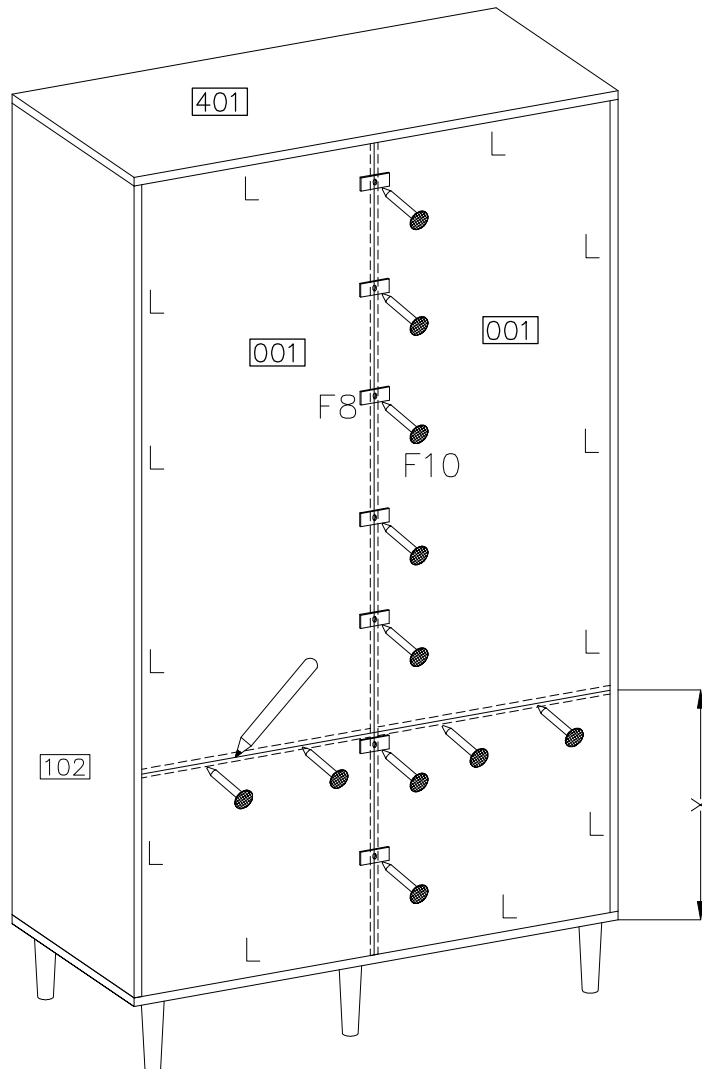
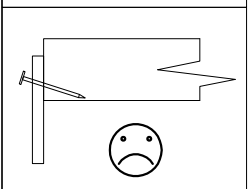
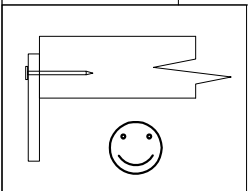
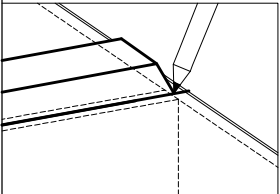
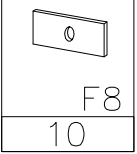
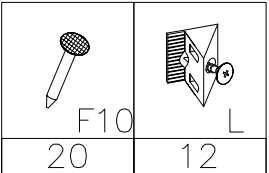

9

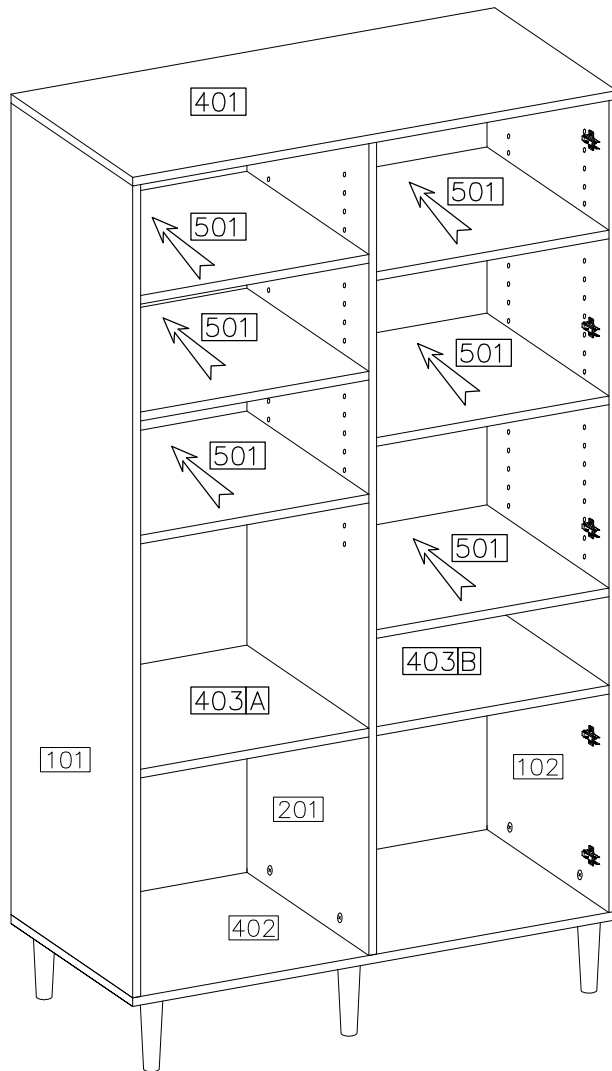

10

<p>∅35/KR-0 G6</p>
<p>10 ∅3.5x16mm</p> <p>P3</p>
<p>20 M4.0x22mm</p> <p>R3</p>
<p>4</p> <p>S1</p>
<p>4</p>

