

# LIGHT 180

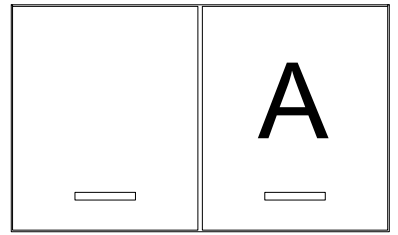

PD

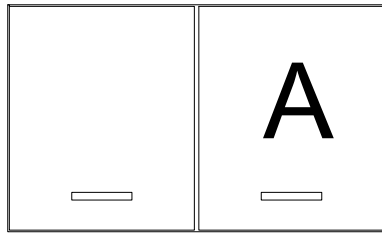
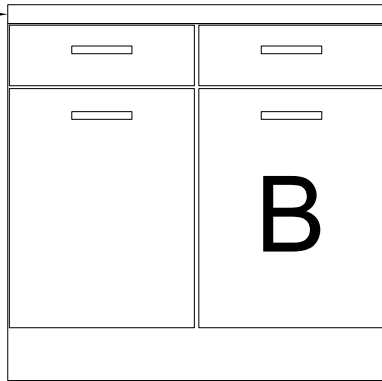

PD

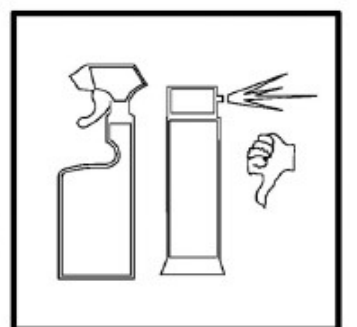
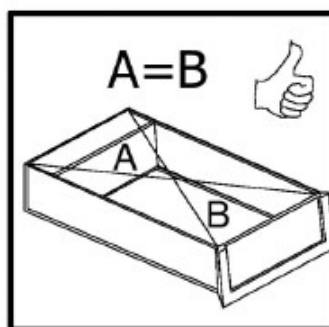
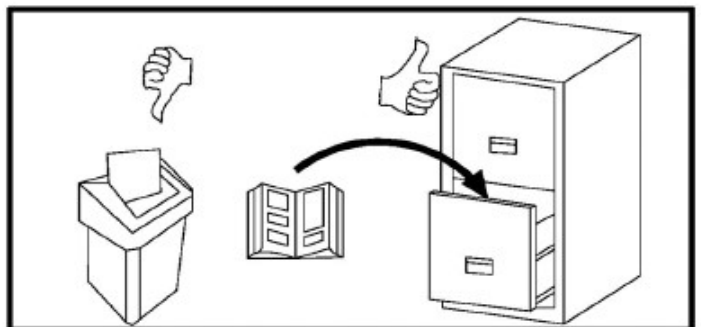
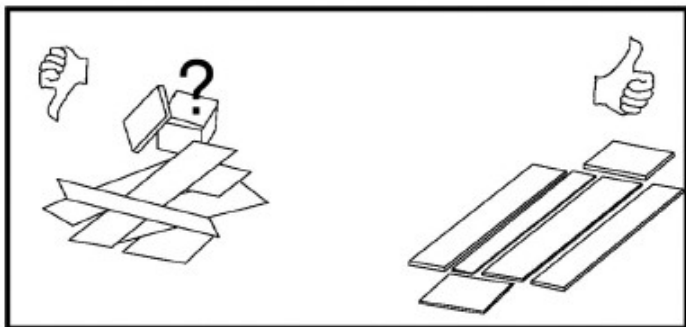
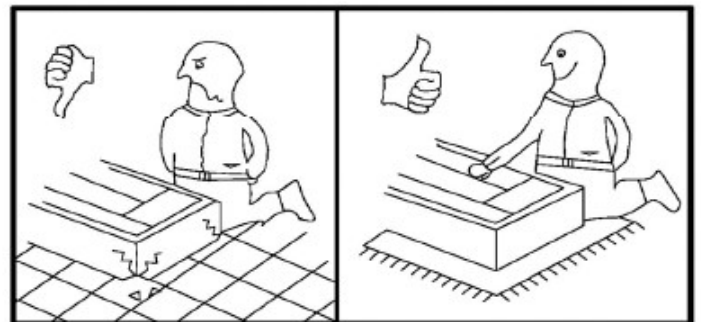
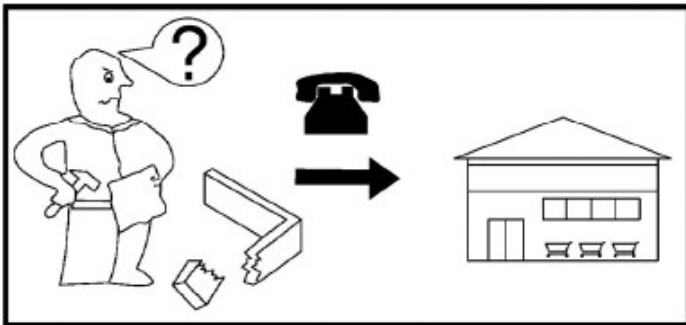
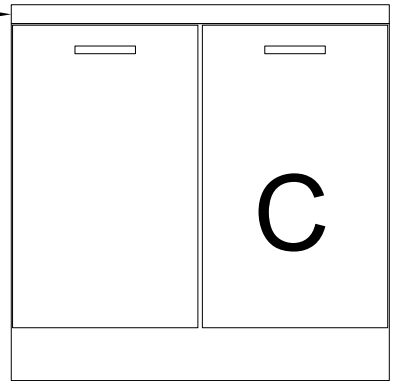



## Obecné informace:

Montáž kuchyně by měli provádět vyškolení odborníci. Před montáží je potřeba si přečíst montážní návod. Dodržujte montážní pokyny a postupy jednotlivých komponentů, jako jsou dřez, osvětlení apod.

### Pro připevnění nástěnných závěsných prvků použijte:

Balení nezahrnuje žádný připevňovací materiál k uchycení skříňek na zeď. Zkontrolujte prosím stav zdi a navštivte specializovaného prodejce za účelem nákupu hmoždinek a šroubů.



Při správném sestavení lze nástěnné skříňky zatížit maximálně 40 kg. Dbejte na rovnoměrné rozložení obsahu skříňky. Při nedodržení pokynů k instalaci nemůžeme nést žádnou odpovědnost za způsobené škody na majetku či zdraví. Nezapomeňte připevnit ochranu proti překlopení na jednotlivé skříňky.

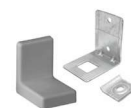

Před vrtáním je třeba zkontrolovat, zda v místě vrtání není vedeno potrubí pro plyn, vodu, elektřinu, topení, kanalizaci nebo jiný typ vedení.

Sanitární a elektrickou instalaci smí provádět pouze příslušný odborník. Na příslušenství nebo elektrických zařízeních nelze provádět žádné změny. To platí zejména pro montážní otvory. Při instalaci zkontrolujte, zda jsou k dispozici všechna připojení a zda byla provedena správně.

Balení obsahuje malé části, které by mohly děti spolknout. Proto nenechávejte děti mladší 3 let bez dozoru.

### Doporučený postup pro montáž kuchyně:

Balíky rozbalujte pomalu s ohledem na prostor, aby se při rozbalování nepoškodily jednotlivé díly. Před montáží si přečtěte montážní návod a připravte si potřebné pomocné nářadí.

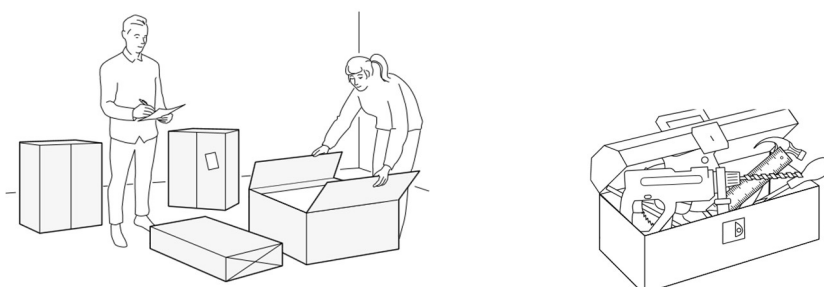

Naplánujte si přesně místo instalace s ohledem na vaše vodovodní a elektrické připojení. Zkontrolujte, zda vaše lednička s mrazákem vyžaduje ventilační otvory v oblasti podstavce nebo v oblasti pracovní desky. Pokud je to nutné, pořídte si vhodné větrací mřížky od specializovaného prodejce. Podstavec nebo pracovní desku vyřízněte podle pokynů výrobce zařízení. Vše důkladně přeměřte a pokud to vyžaduje situace, pracujte ve dvojici.

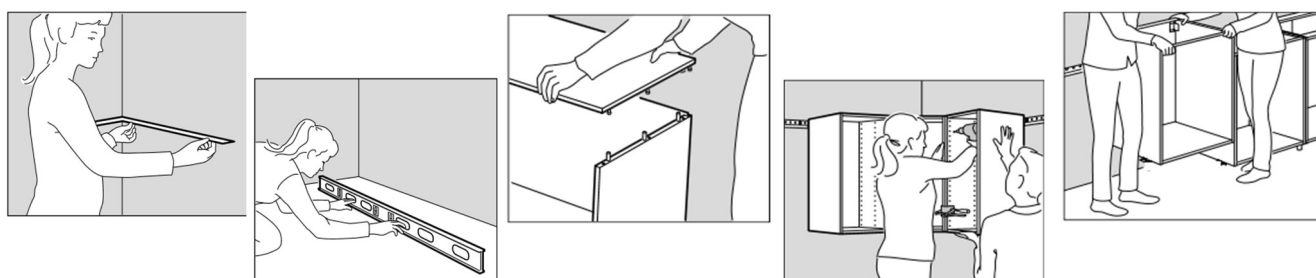

Nejprve sestavte spodní skříňky a srovnejte je vodováhou. Pokud to vyžaduje tvar kuchyně, spojte jednotlivé skříňky šrouby tak, aby byly skříňky v rovině. Šrouby jsou součástí balení. Doporučujeme použít dvě svěrky pro zamezení pohybu.

Povrchy skříněk lze chránit před prohloubeními dalšími kousky desek, které najdete v balení jako podpurný materiál zabraňující pohyb. Na překrytí můžete použít karton co vám zbyde.

Přesným měřením určete polohy otvorů pro závěsné kování.

Šrouby utáhněte s ohledem na materiál tak, aby nevykukovali, ani nešly hlouběji.

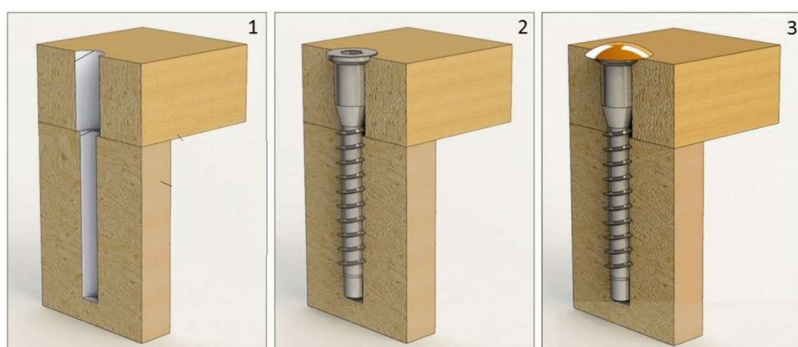

### Doporučený postup pro úpravu pracovní desky: osazení varných desek, dřezů apod.

Umístěte pracovní desku na rámy, vyrovnejte ji a zafixujte svěrkami. Vyznačte polohu a rozměry prvku na osazení do pracovní desky. Na spodní straně pracovní desky označte výřez varné desky nebo dřezu. Vycentrujte jej tak, aby dřez / varná deska seděl uprostřed základny a zbyvajících šířka pracovní desky byla přibližně vpředu i vzadu stejná, pokud je to možné. Abyste si usnadnili vyřezávání otvoru, navrhujeme okraj výřezu přelepit papírovou lepicí páskou a vyvrtat si otvory do rohů výřezu o průměru minimálně 10 mm. Vždy pracujte ze spodní strany desky, aby se nepoškodila její pohledová strana. Výřezy a neopracované hrany můžete chránit například silikonem.

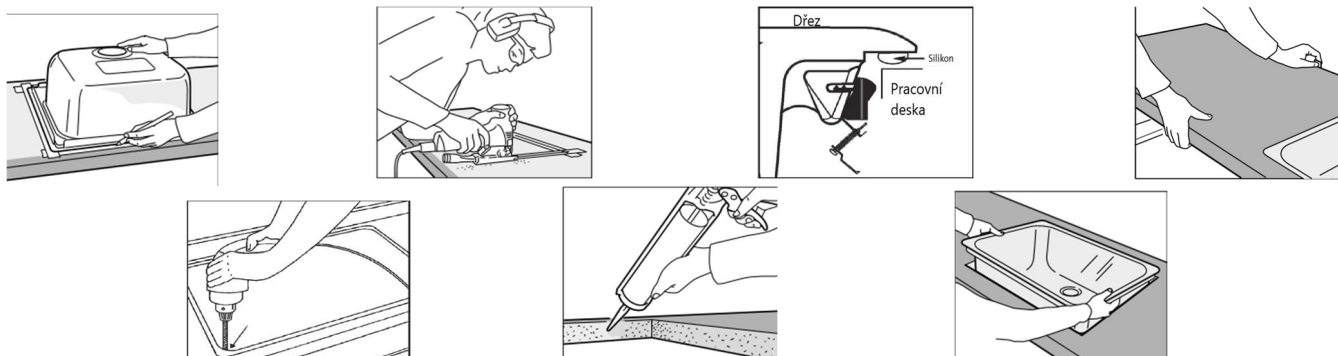



## Všeobecné informácie:

Montáž kuchyne by mali robiť vyškolení pracovníci. Pred montážou je potrebné prečítať si montážny návod. Dodržiajte montážne pokyny a postupy jednotlivých komponentov, ako sú drez, osvetlenie a iné.

### Na upevnenie závesných prvkov použite:

Balenie nezahŕňa žiadny upevňovací materiál na uchytenie skriniek na stenu. Skontrolujte prosím stav stien a navštívte špecializovaného predajcu za účelom nákupu hmoždiniek a skrutiek.



Pri správnom zostavení je možné závesné skrinky zaťažiť maximálne 25 kg. Dbajte na rovnomerné rozloženie obsahu skrinky. Pri nedodržaní pokynov k inštalácii nemôžeme niesť žiadnu zodpovednosť za škody spôsobené na majetku či zdraví. Nezabudnite pripevniť ochranu proti preklopeniu na jednotlivé skrinky.



Pred vŕtaním, je potrebné skontrolovať, či v mieste vŕtania nie je vedené potrubie na plyn, vodu, elektrinu, kúrenie, kanalizáciu alebo iný typ vedenia.

Sanitárne a elektrické inštalácie môže vykonávať iba príslušný odborník. Na príslušenstve alebo elektrických zariadeniach nemožno robiť žiadne zmeny. To platí hlavne pre montážne otvory. Pri inštalácii skontrolujte, či sú k dispozícii všetky pripojenia a či sú správne.

V balíkoch kuchynského nábytku sa nachádzajú malé časti, ktoré by mohli prehltnúť deti. Preto nenechávajte deti bez dozoru.

### Odporúčaný postup pre montáž kuchyne:

Balíky rozbaľujte pomaly s ohľadom na rozmery miestnosti, aby sa nepoškodili jednotlivé dielce. Pred montážou si prečítajte montážny návod a pripravte si potrebné pomocné náradie.

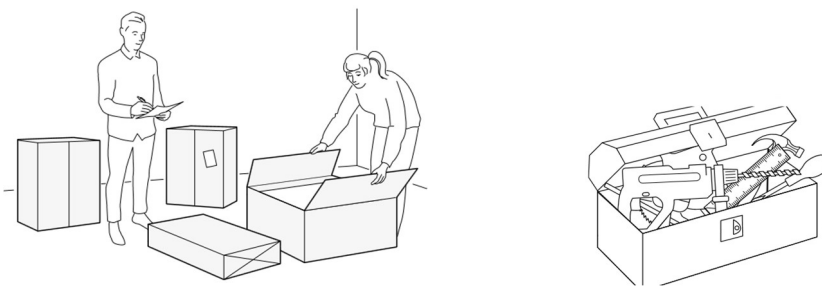

Naplánujte si presne miesto inštalácie s ohľadom na vaše vodovodné a elektrické pripojenie. Skontrolujte, či vaša chladnička s mrazničkou vyžaduje ventilačné otvory v oblasti podstavca alebo v oblasti pracovnej dosky. Pokiaľ je to potrebné, zožehňte si vhodné vetracie mriežky od špecializovaného predajcu.

A podstavec alebo pracovnú dosku vyrežte podľa pokynov výrobcu zariadenia. Všetko si poriadne premerajte a pokiaľ to vyžaduje situácia, pracujte vo dvojici.

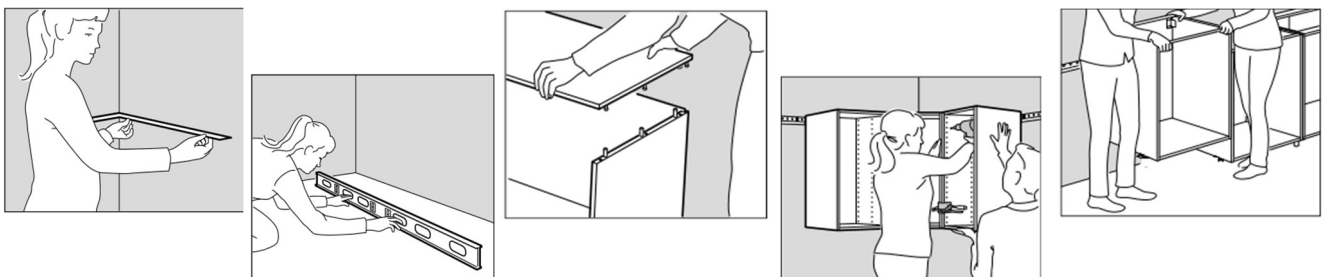

Najskôr poskladajte spodné skrinky a zarovnajte ich vodováhou. Ak to vyžaduje tvar kuchyne, spojte jednotlivé skrinky spojovacími skrutkami tak, aby boli skrinky v rovine. Skrutky sú súčasťou balenia. Odporúčame použiť dve svorky na zamedzenie pohybu skriniek.

Povrch skriniek môžete chrániť pre poškodením ďalšími kúskami dosiek, ktoré nájdete v balíoch ako podporný materiál zabraňujúci pohybu. A na zakrytie môžete použiť kartón, ktorý vám zostáva z balíkov.

Presným meraním určite polohu otvorov pre závesné kovanie.

Skrutky utiahnite s ohľadom na materiál, tak aby netrčali a zároveň nešli príliš hlboko.

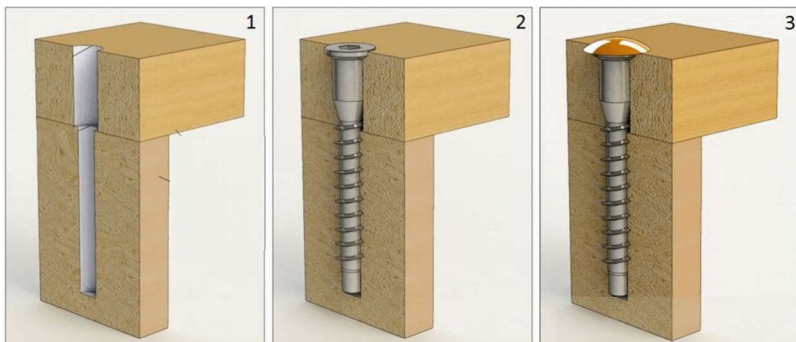

### Odporúčaná postup pre úpravu pracovnej dosky: osadenie varných dosiek, drezov a pod.

Umiestnite pracovnú dosku na rámy, vyrovnajte ju a zafixujte svorkami. Vyznačte polohu a rozmery prvku na osadenie do pracovnej dosky. Na spodnej strane pracovnej dosky označte výrez varnej dosky, či drezu. Vycentrujte ju tak, aby drez / varná doska bola približne uprostred základne a ostávajúca šírka vpredu a vzadu bola rovnaká, pokiaľ je to možné. Aby ste si uľahčili vyrezávanie otvoru, navrhujeme okraj výrezu prelepiť papierovou lepiacou páskou a vyvŕtať si otvory v rohoch výrezu o priemere min 10 mm. Vždy pracujte zo spodnej strany dosky, aby sa nepoškodila jej pohľadová strana. Výrezy a neopracované hrany môžete chrániť napr. silikónom.

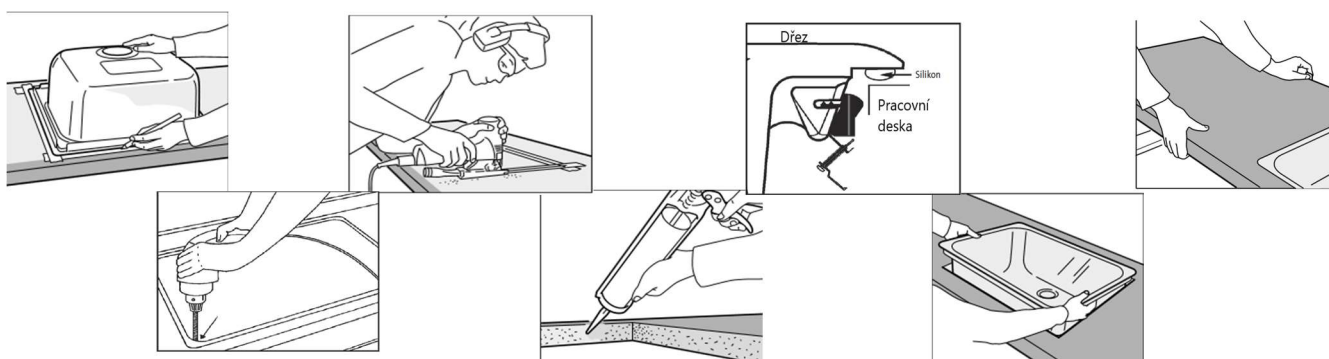



# LIGHT 180

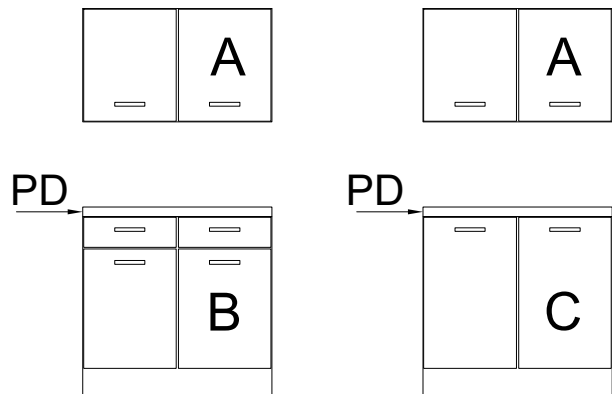

LIGHT 180\_ možné dokúpiť aj iné doplnky a rozšíriť si tak kuchyňu

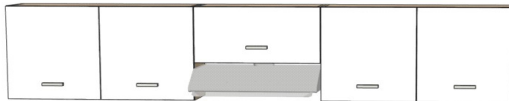

**A 500x900x320**  
**L3 500x900x320**

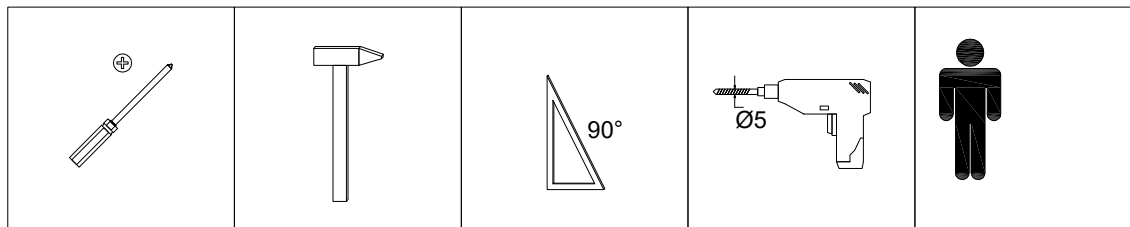
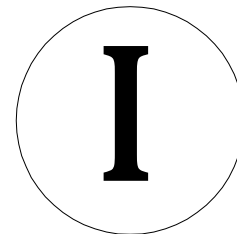
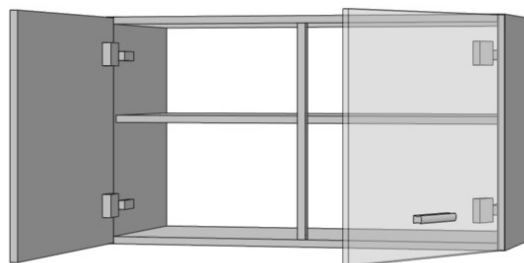
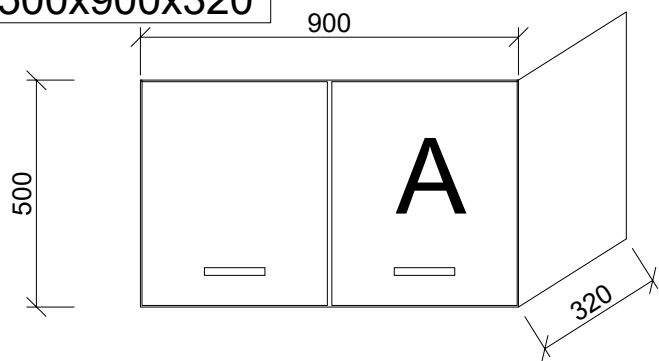

**L**      **S**

D-302	500	300	2x
D-312	868	296	2x
D-319	467	40	1x
D-323	868	296	1x
D-328	496	446	2x
D-348	248	886	2x

Kolik drevenny

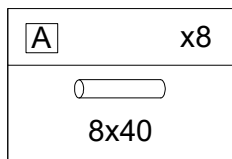

Konfirmat 7x50

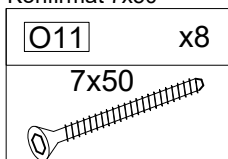

Krytka konfirmat-13mm

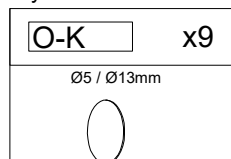

Vrut 3,5x16mm

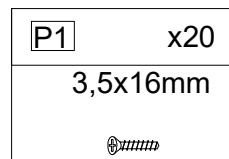

Imbus kluc 4mm

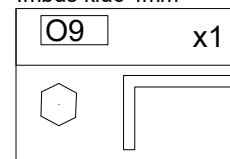

Vrut 4x50mm

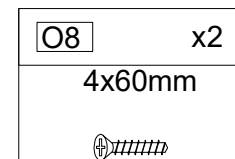

Podperka

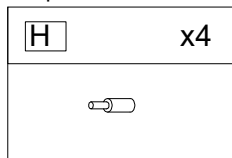

Klinec

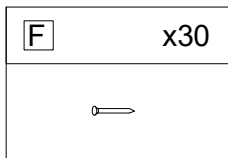

Uholnik

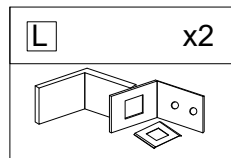

Spojovacia skrutka

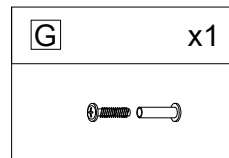

Pant naložený

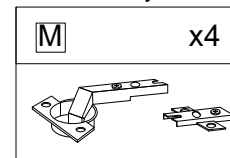

Uchytká - madlo

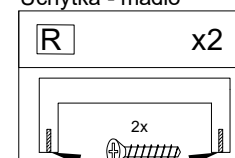

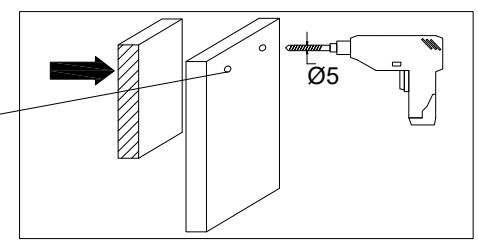
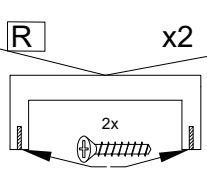
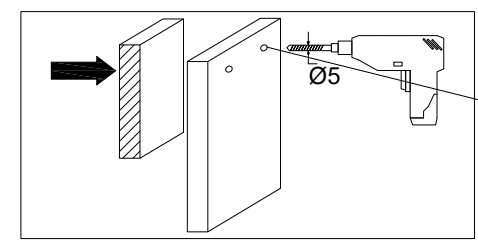
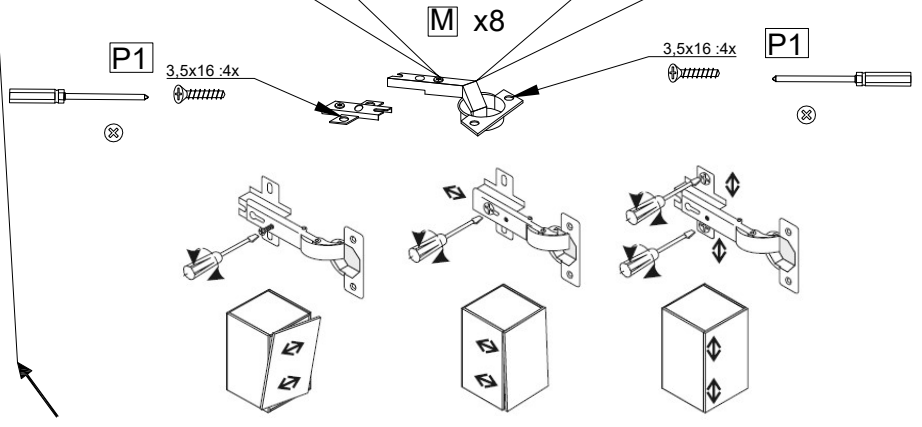
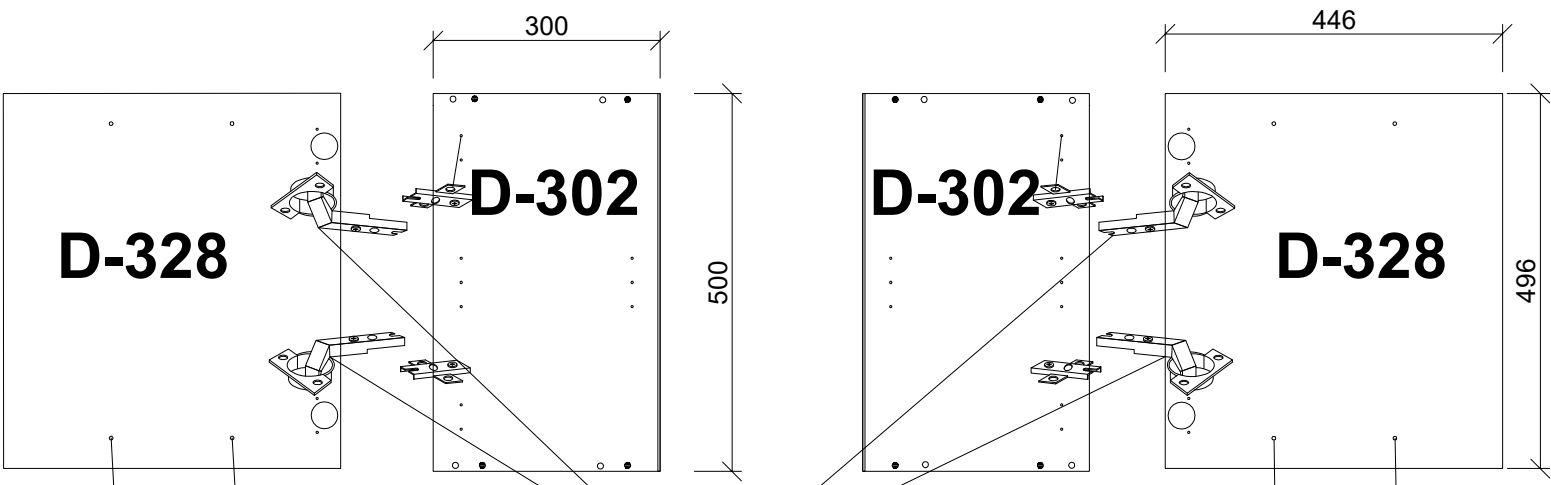
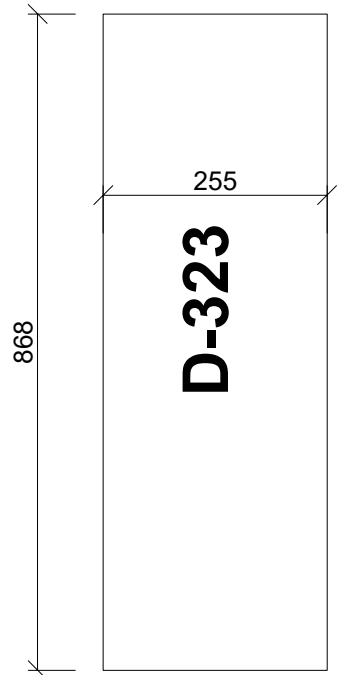
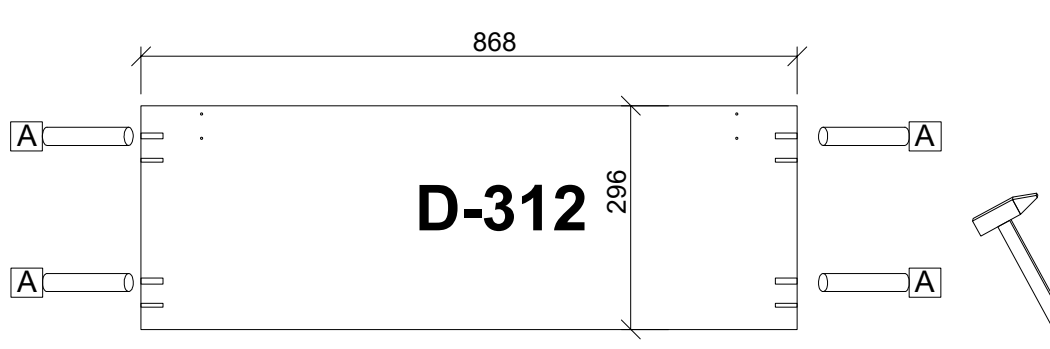
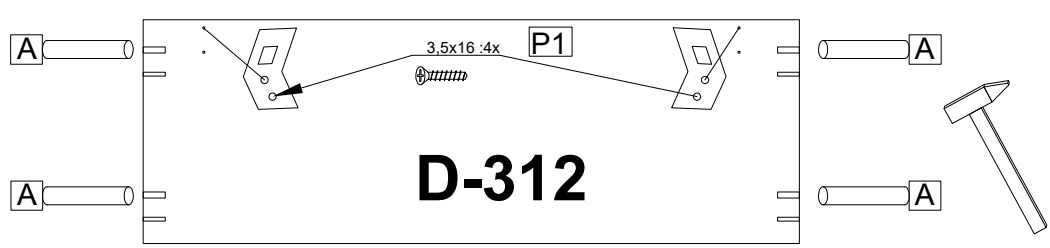
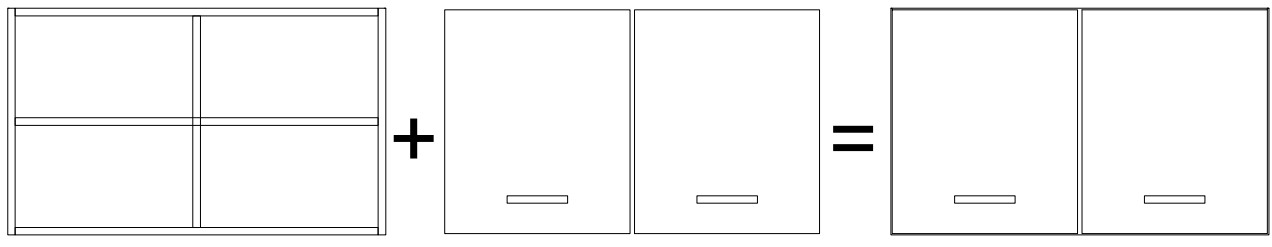



4x60mm  
1x

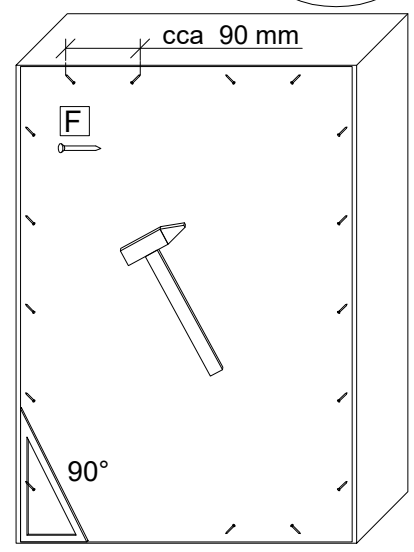
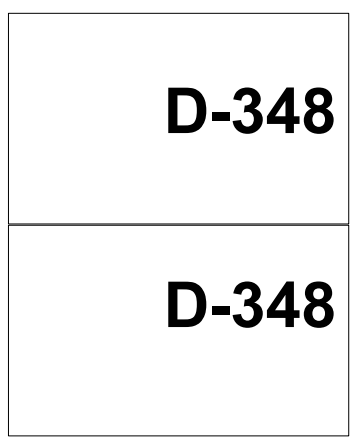
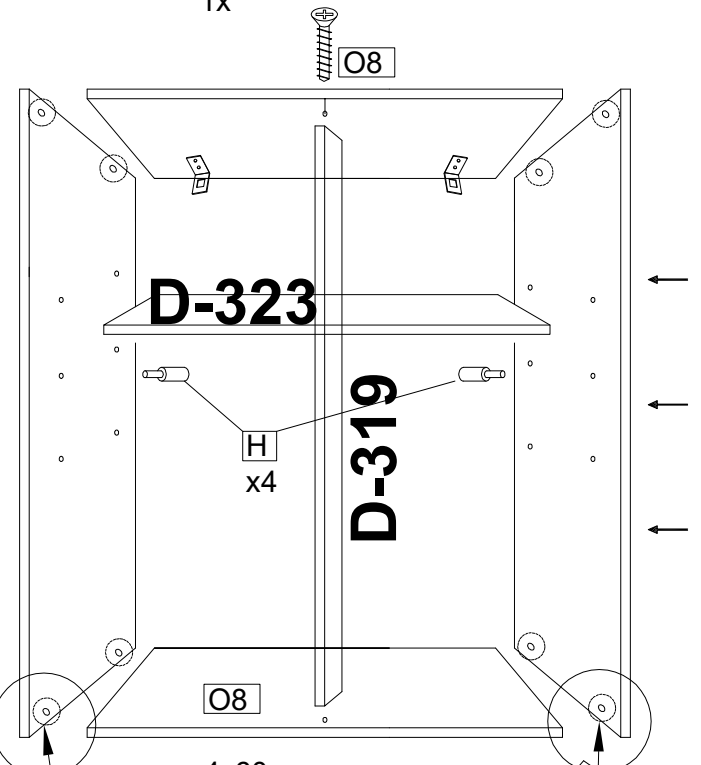

4x60mm  
1x

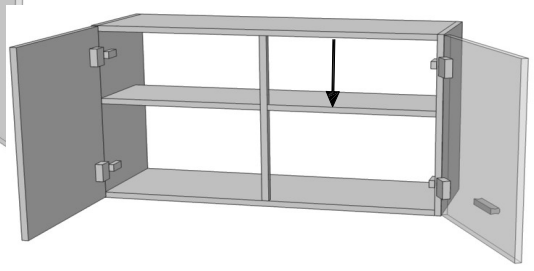
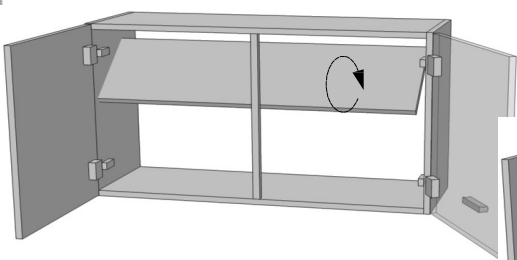
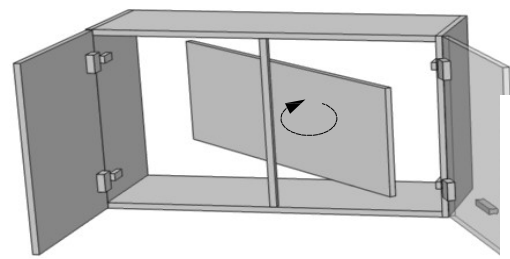
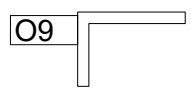
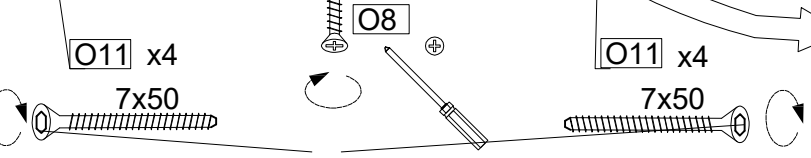

A 500x900x320

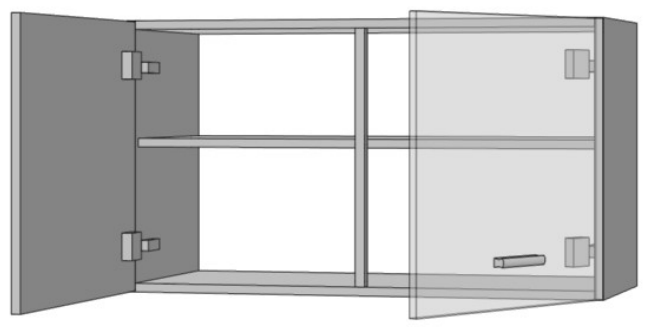

G x1

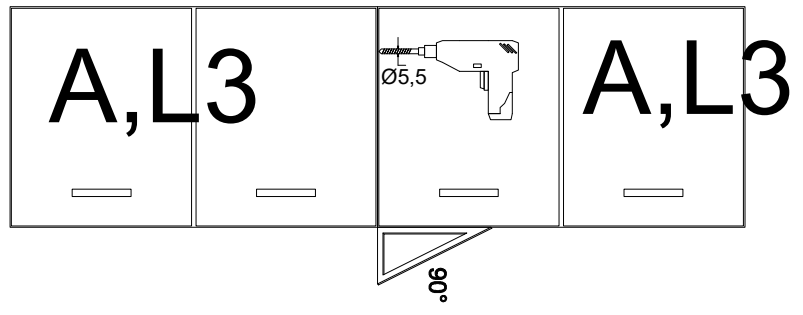

**B 820x900x580**  
**L6 820x900x580**

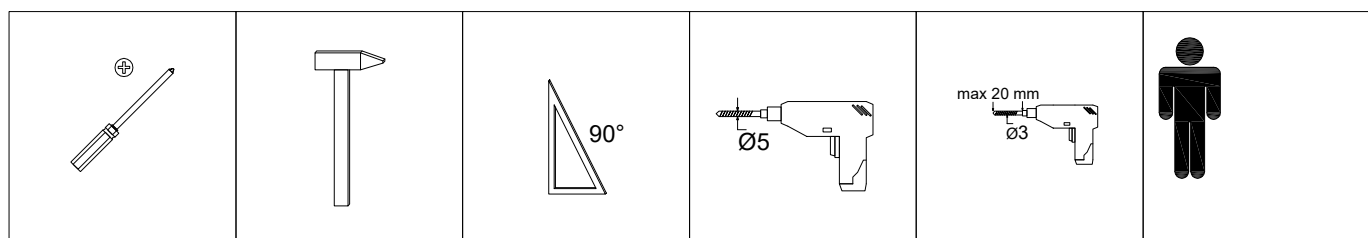
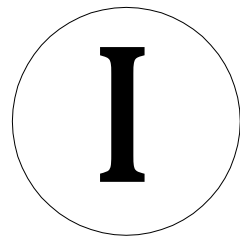
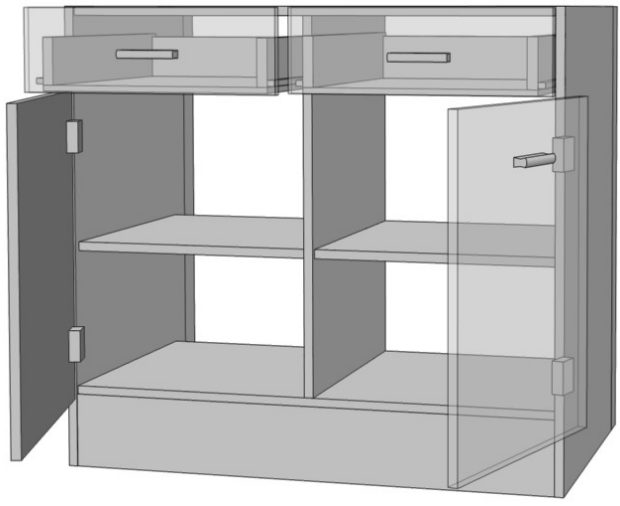
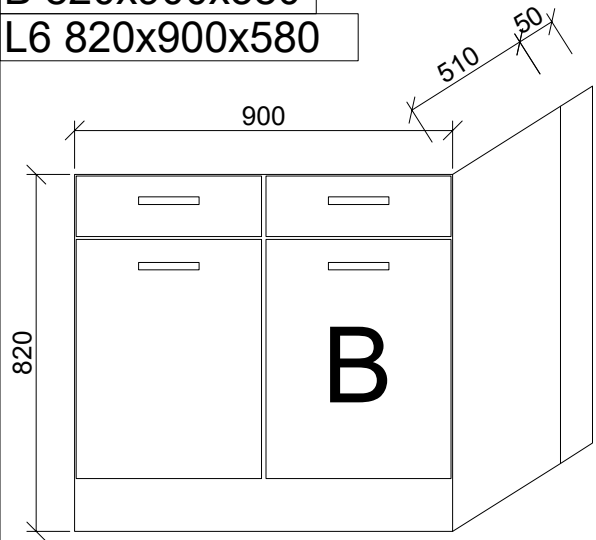

	L	S	
D-305	820	510	1x
D-306	820	510	1x
D-314	868	75	2x
D-316	868	476	1x
D-320	687.5	476.5	1x
D-325	426	476	2x

	L	S	
D-331	692	446	2x
D-332	446	136	1x
D-333	446	136	1x
D-338	868	99	1x
D-341	470	76	2x
D-342	470	76	2x

	L	S	
D-343	369	75	2x
D-348	248	886	2x
D-349	399	477	2x
D-300	800	50	1x

Kolik drevenny

**A** x26

8x40

Krytka excenter-13mm

**B-K** x4

Ø5 / Ø13mm

Klizak v=2mm

**I3** x4

2x40

Vrut 3,5x16mm

**P1** x48

3,5x16mm

Imbus kluc 4mm

x1

Krytka konfirmat-13mm

**O-K** x14

Ø5 / Ø13mm

Narazacia hmozdienka

**B** x4

8x13

Klinec

**F** x30

Montážny plech

**L2** x2

40x16x2

Vrut 3,5x30mm

**P2** x6

3,5x30mm

Uchytka - madlo

**R** x4

2x

Tiahlo

**B1** x4

8x40

Spojovacia skrutka

**G** x2

Pant nalozeny

**M** x4

Vrut 3,5x12mm

**P3** x16

3,5x12mm

Kolajnice

**P** x2

P-R

P-L

P-R

P-L

Excenter

**B2** x4

15x13

Podperka

**H** x8

Vrut 3x25mm

**O** x8

3x25mm

Konfirmat 7x50

**O11** x14

7x50

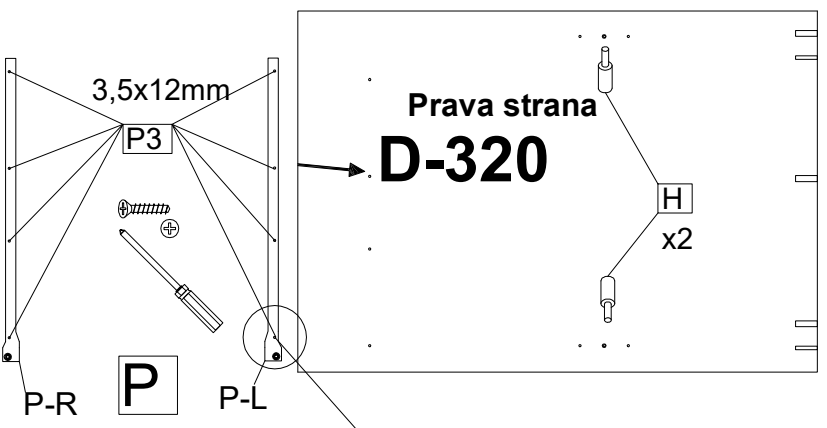
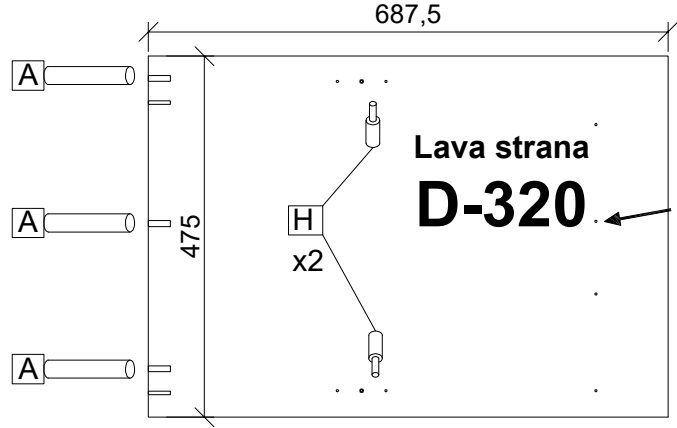
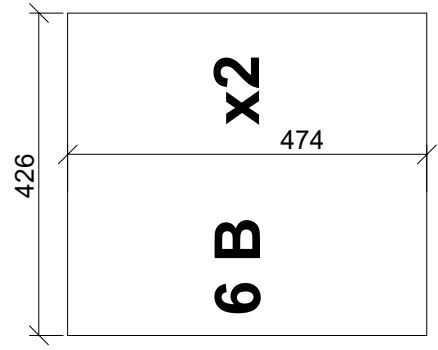
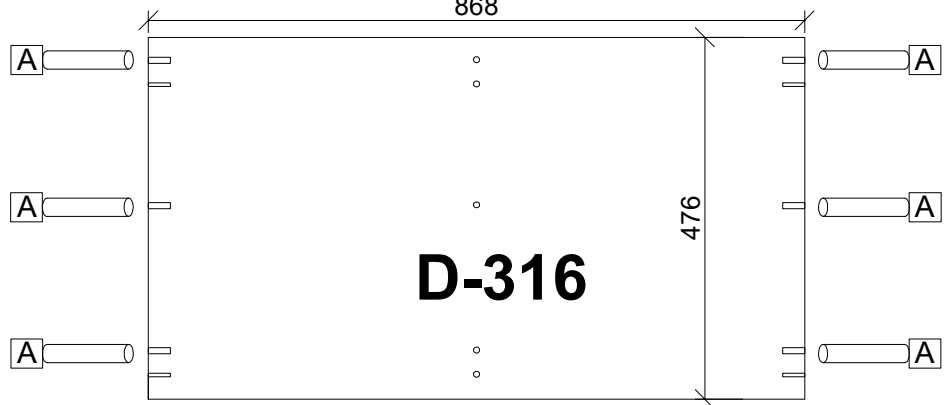
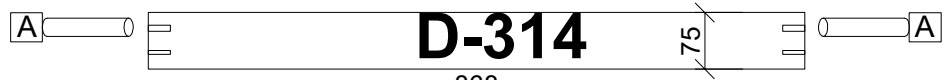
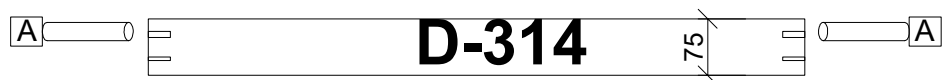
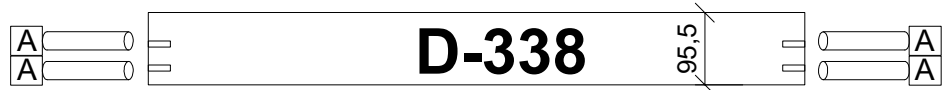
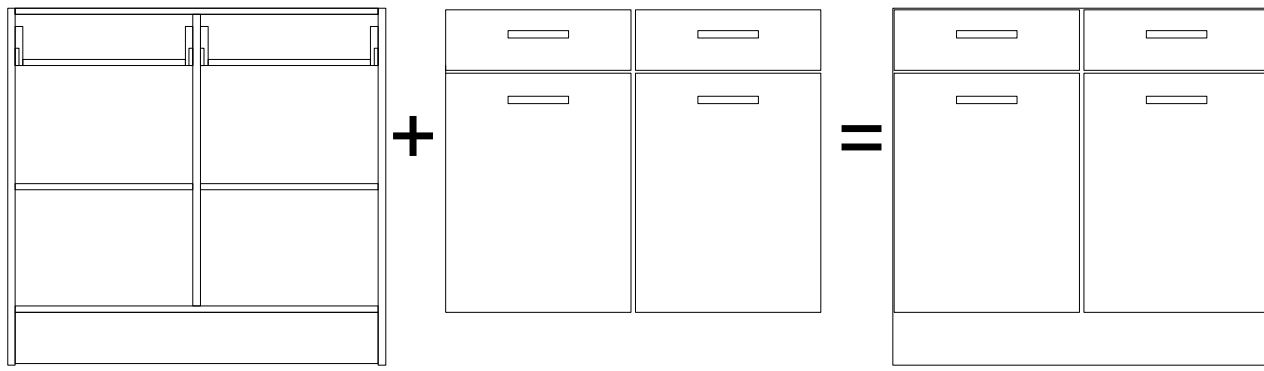

Kolajnice

<b>P</b>	<b>x2</b>
	P-R
	P-L
	P-R
	P-L

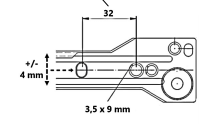

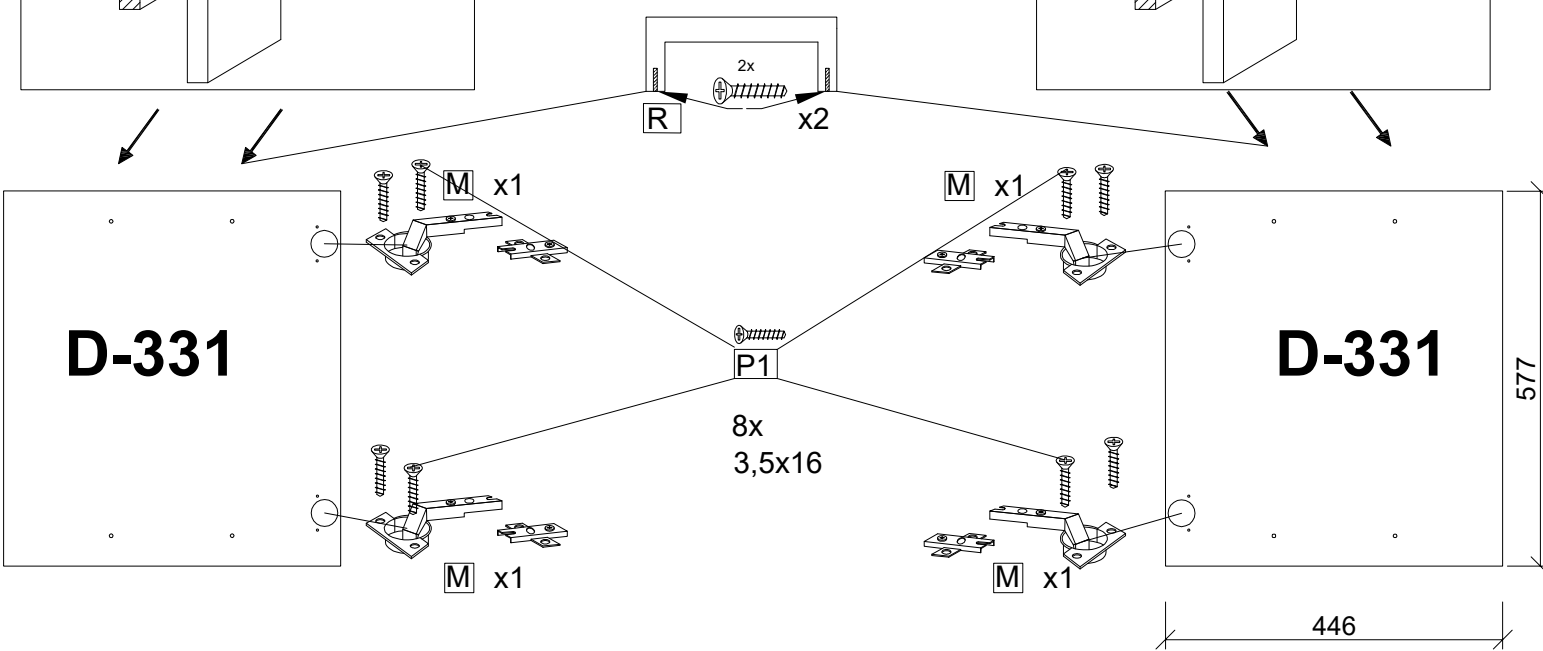
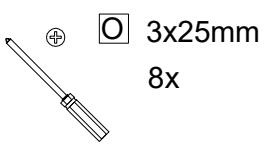
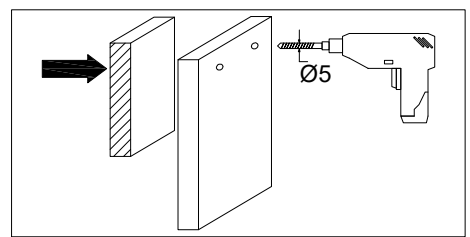
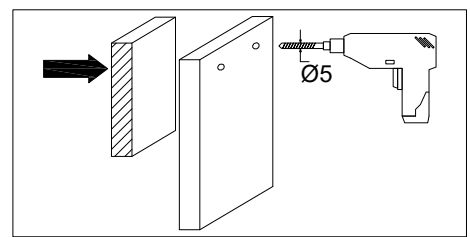
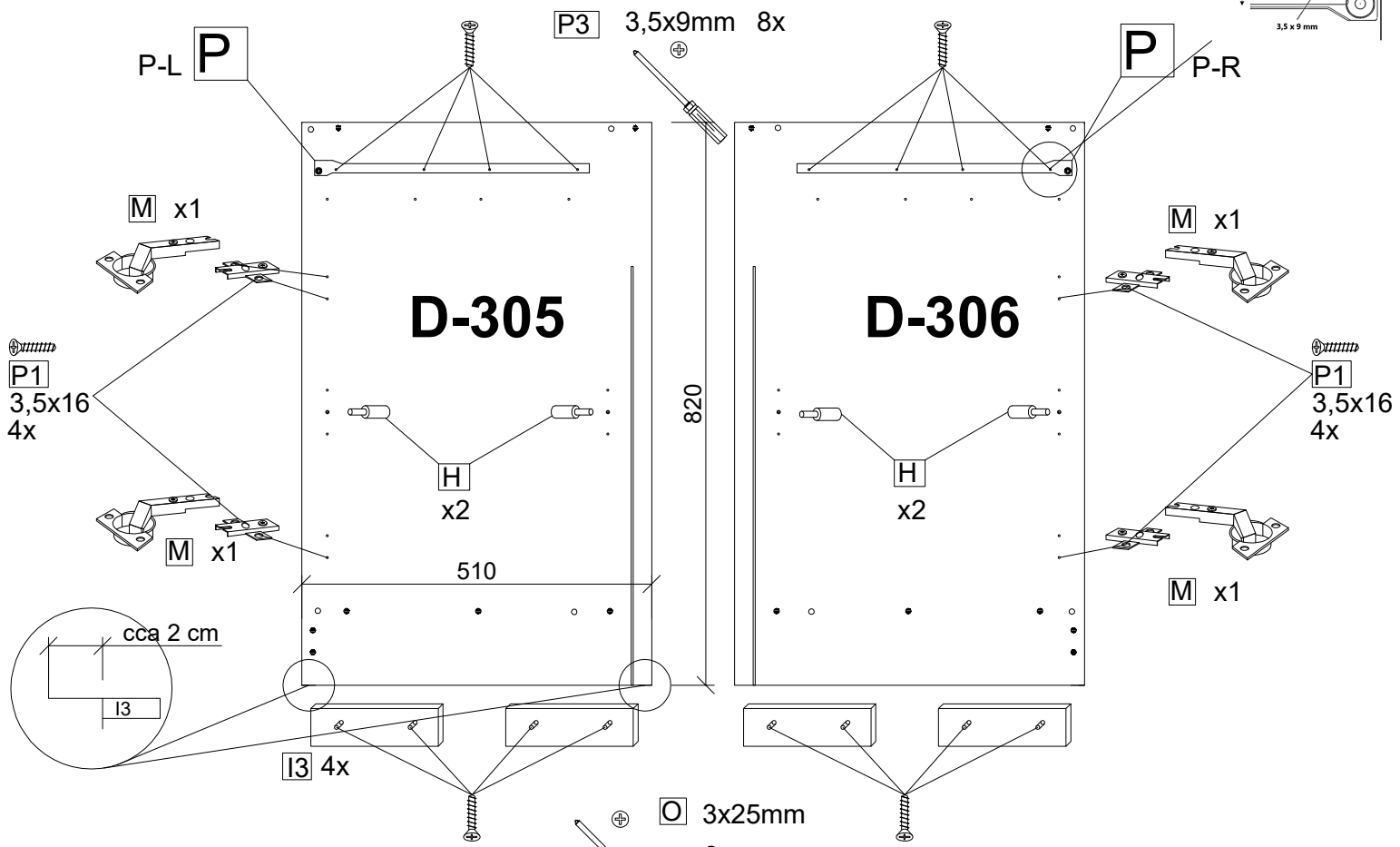
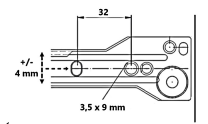
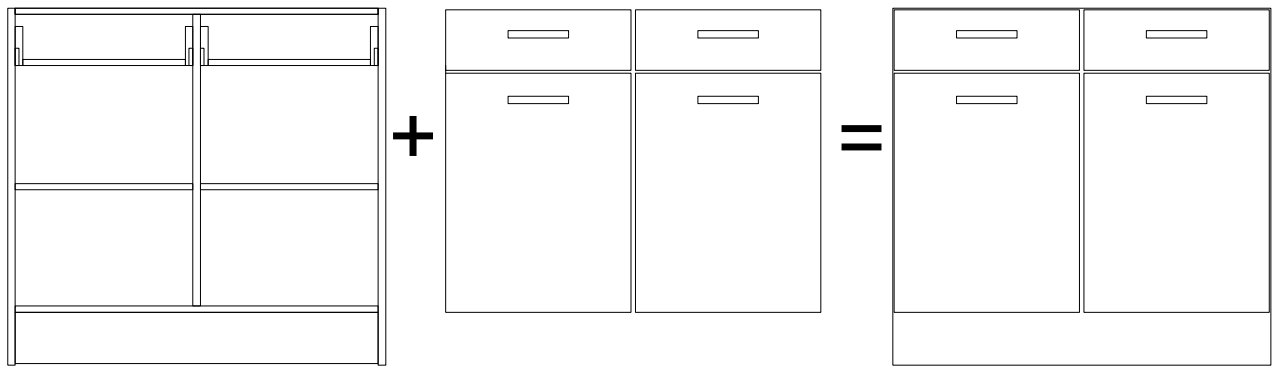
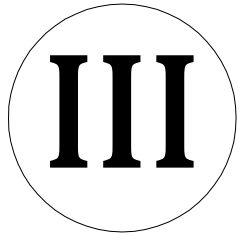

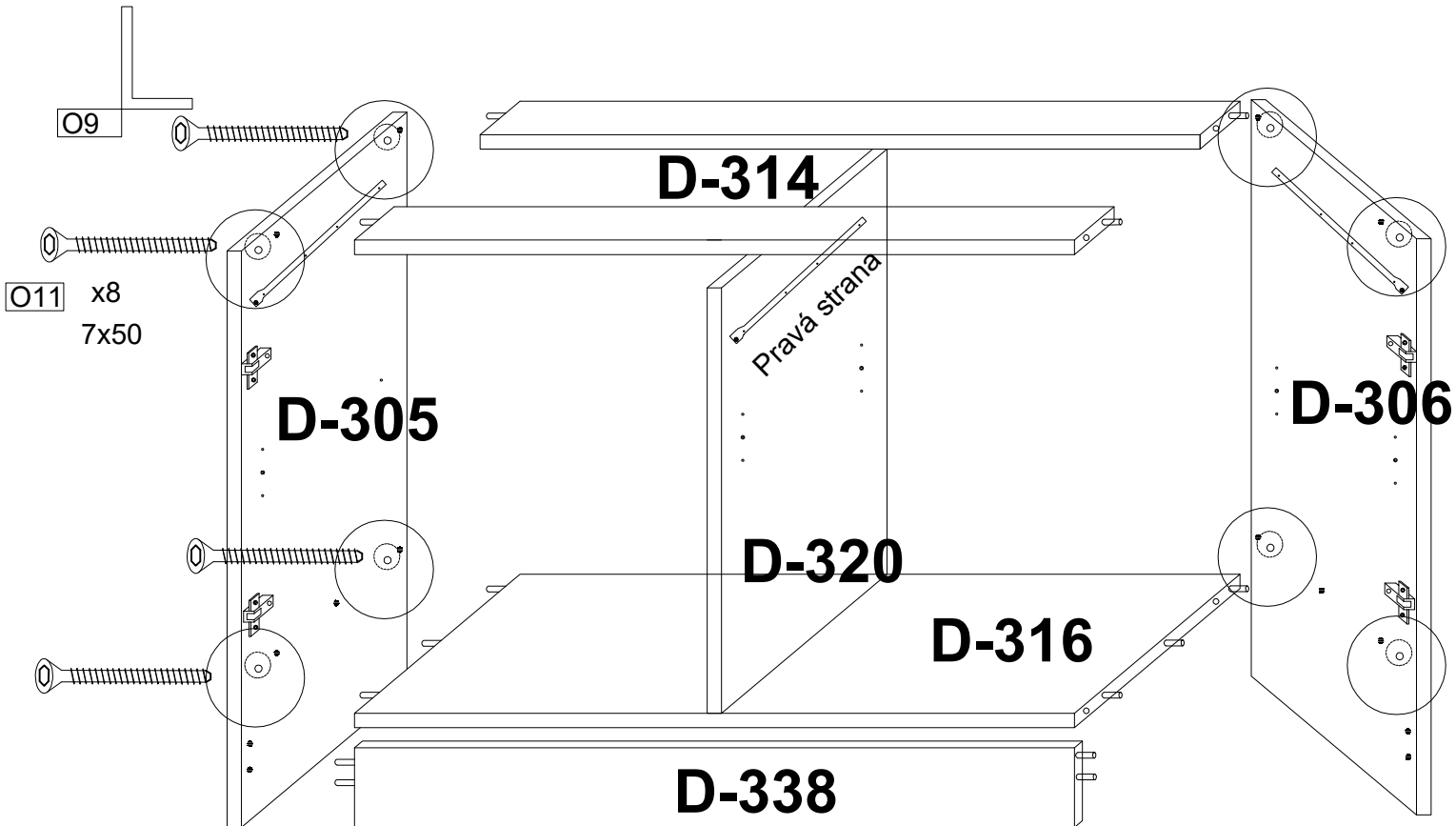
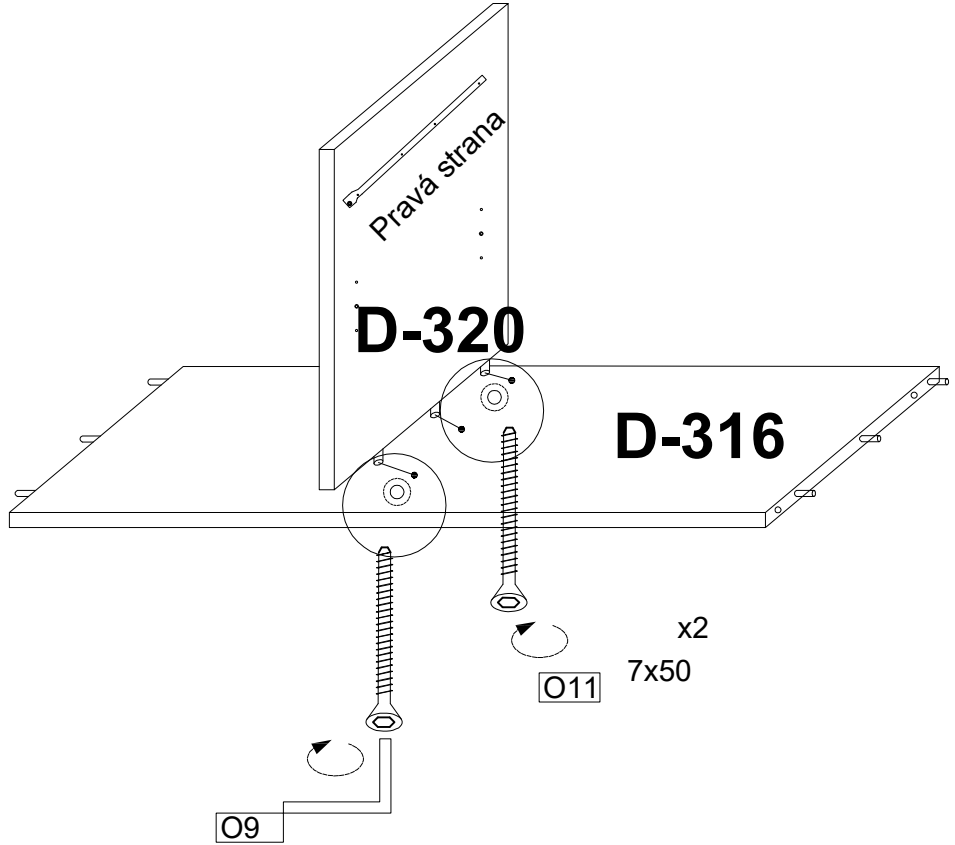
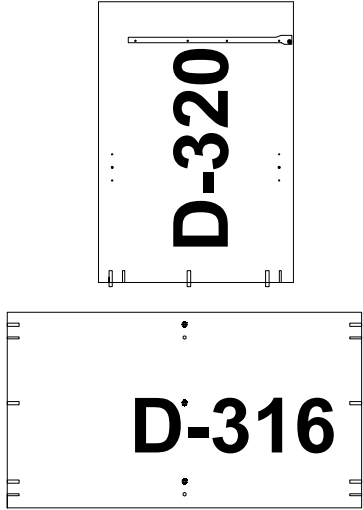
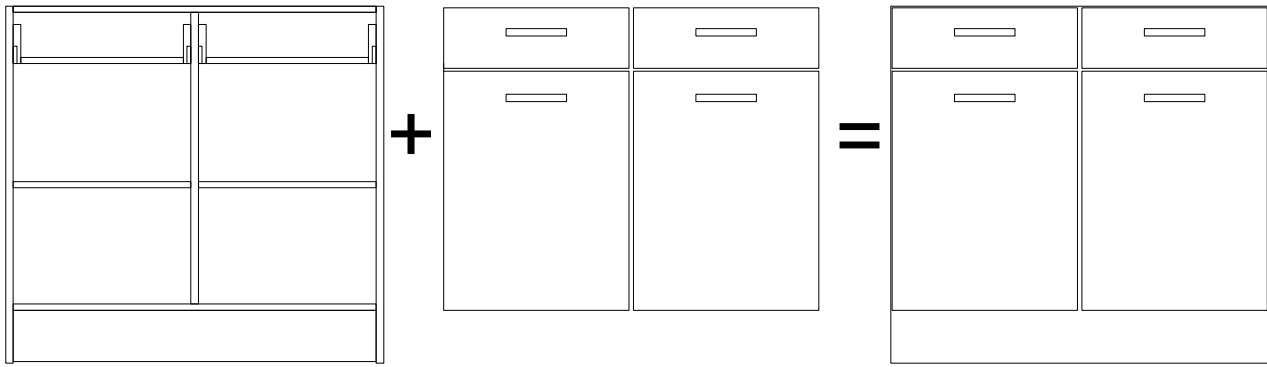

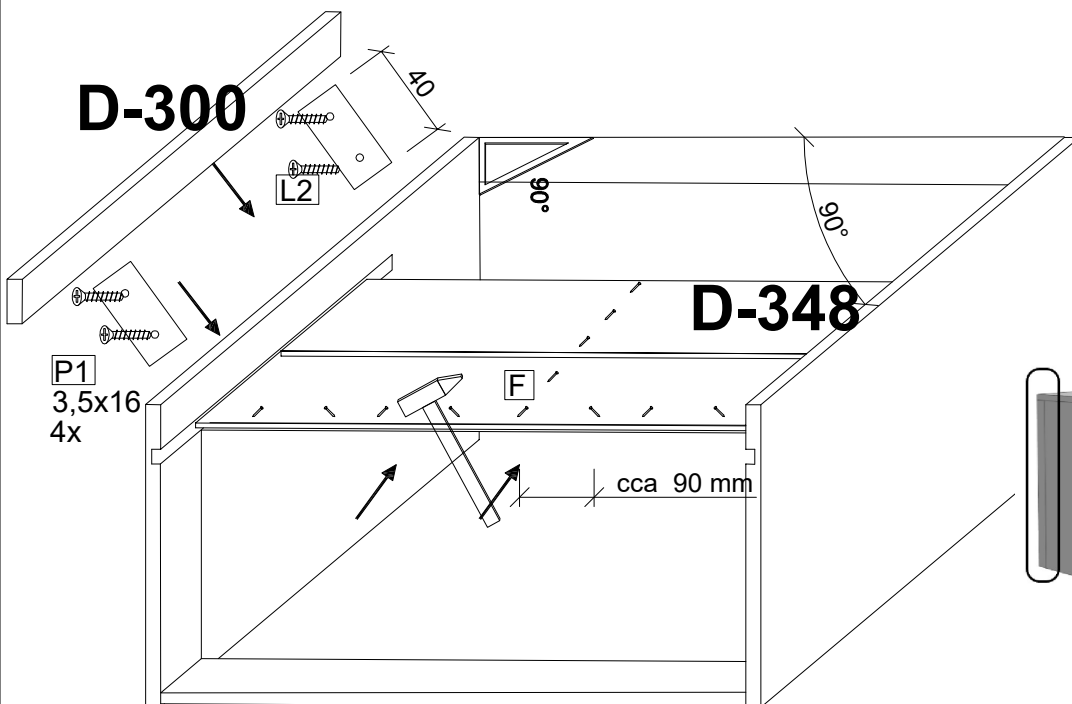
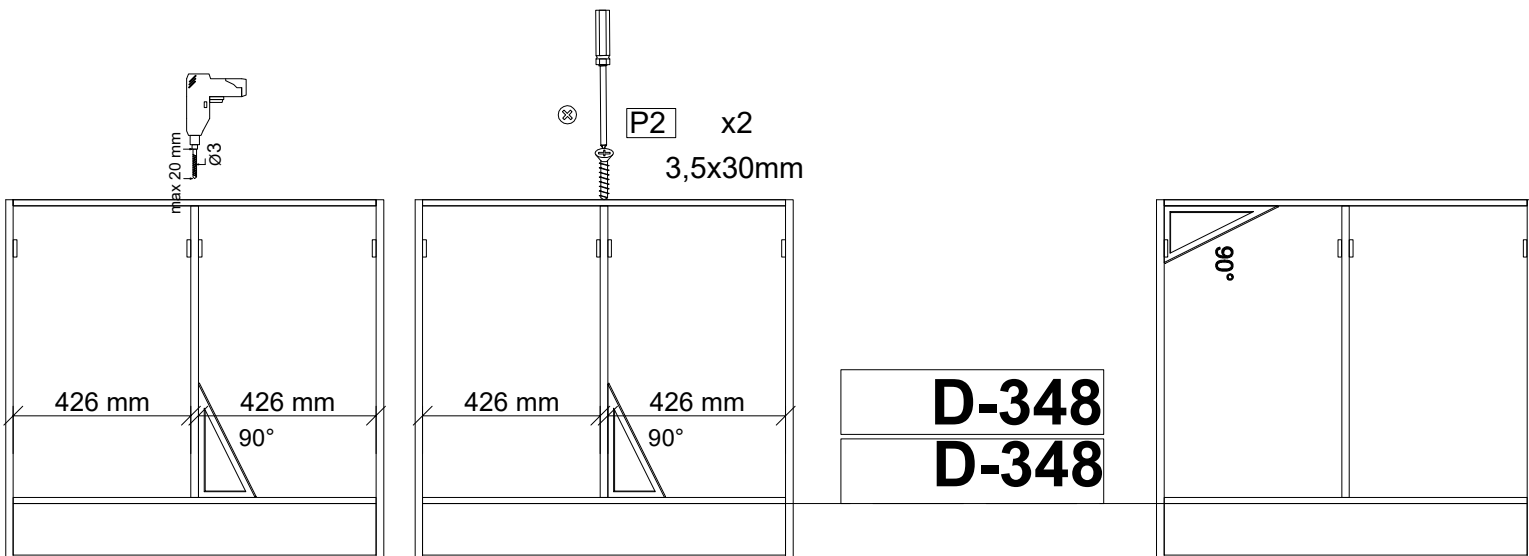
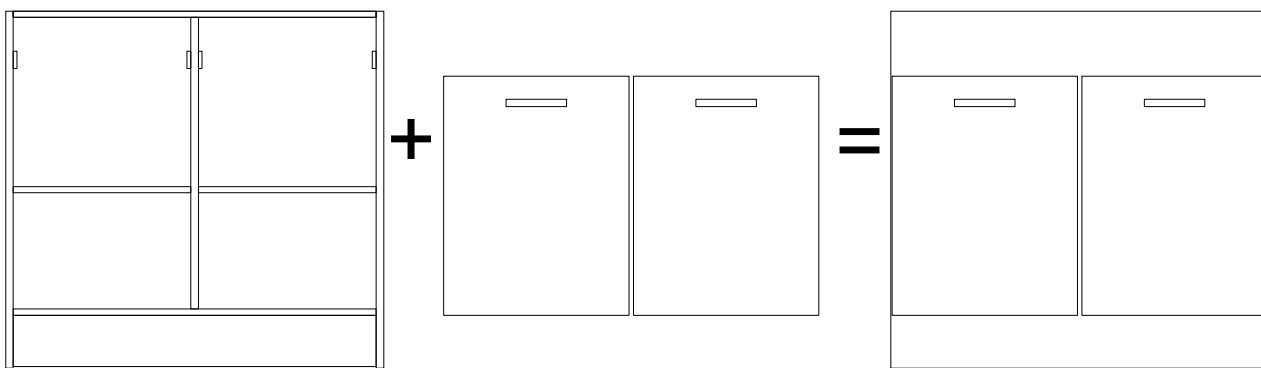
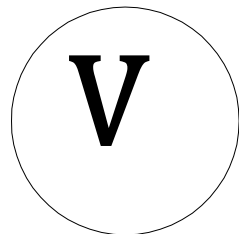

**D-300** len na kraj  
kuchyne

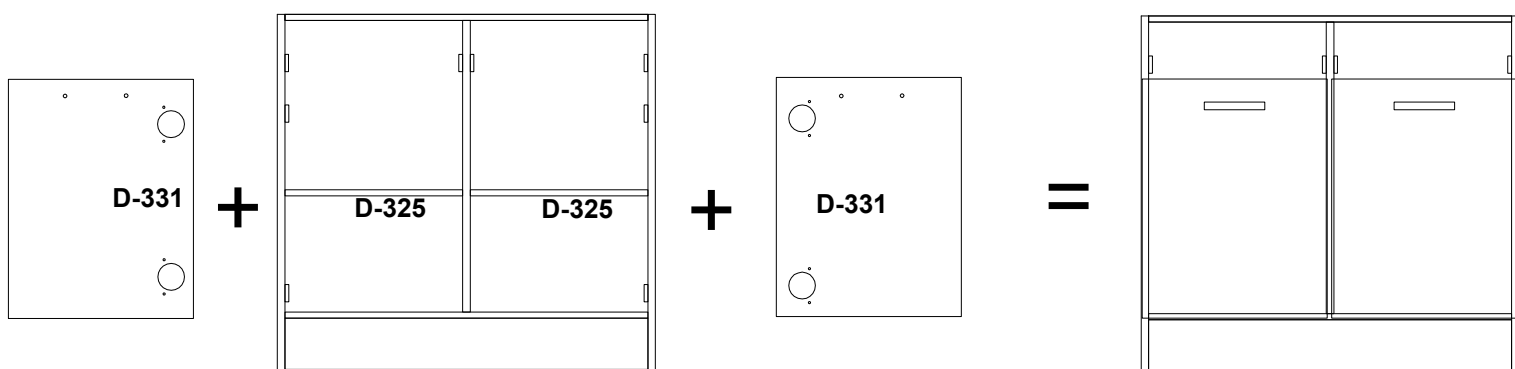
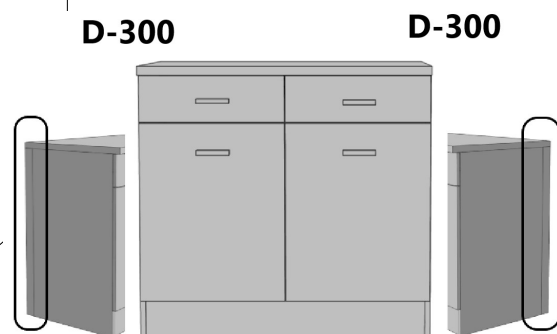

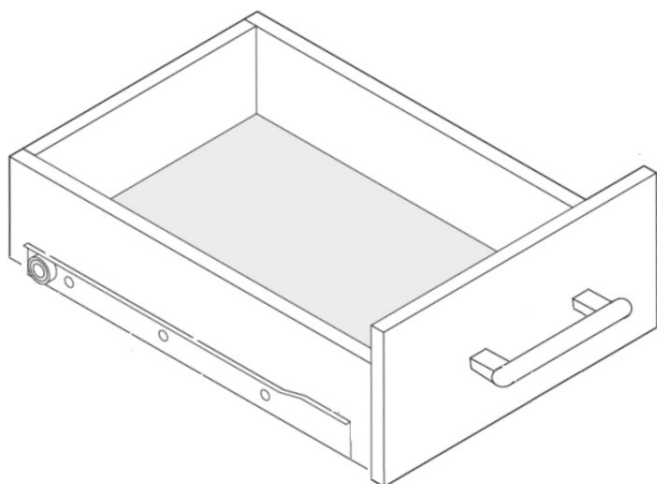
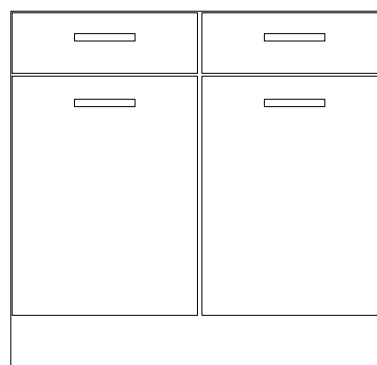
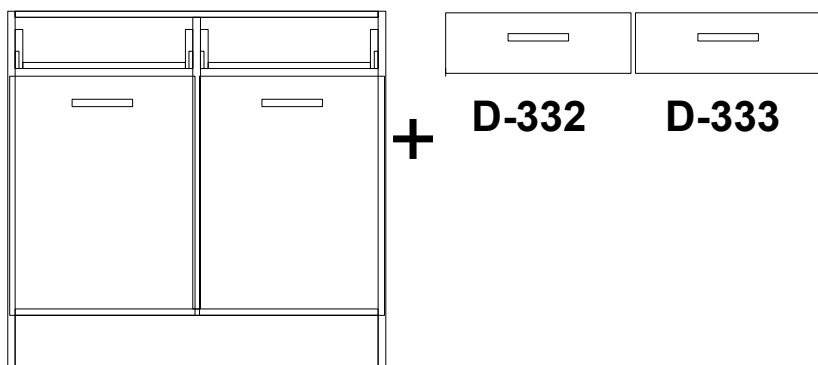

Kolik drevenný

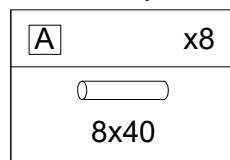

Krytka excenter-13mm

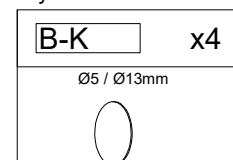

Narazacia hmozdienka

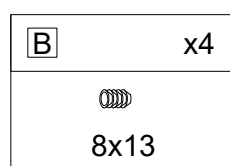

Vrut 3,5x16mm

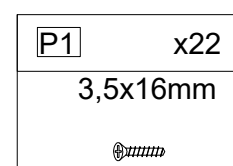

Tiahlo

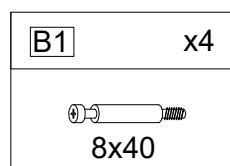

Excenter

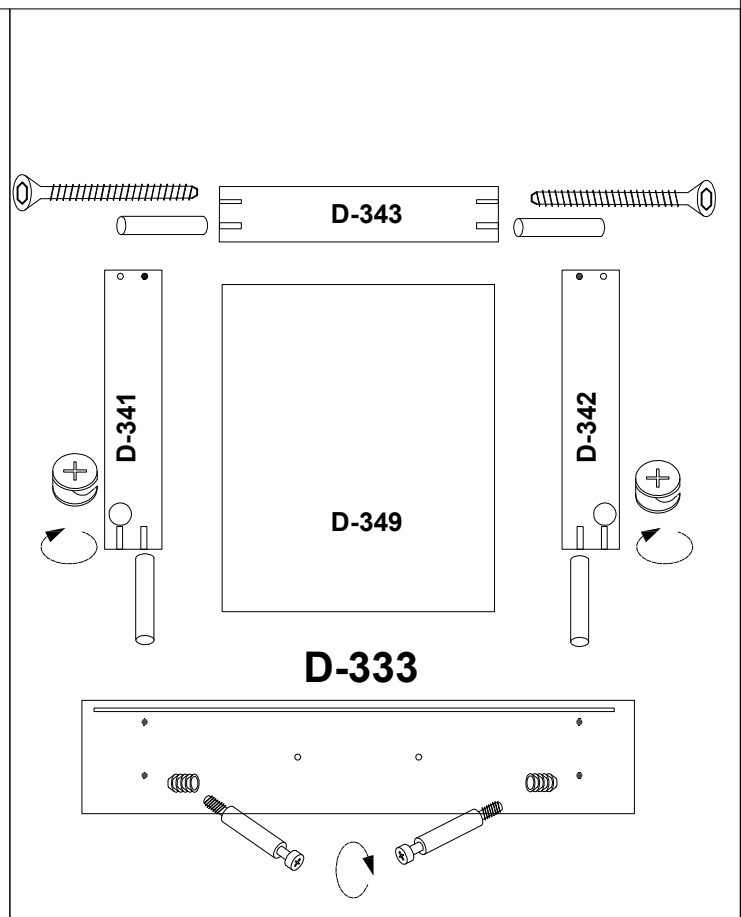
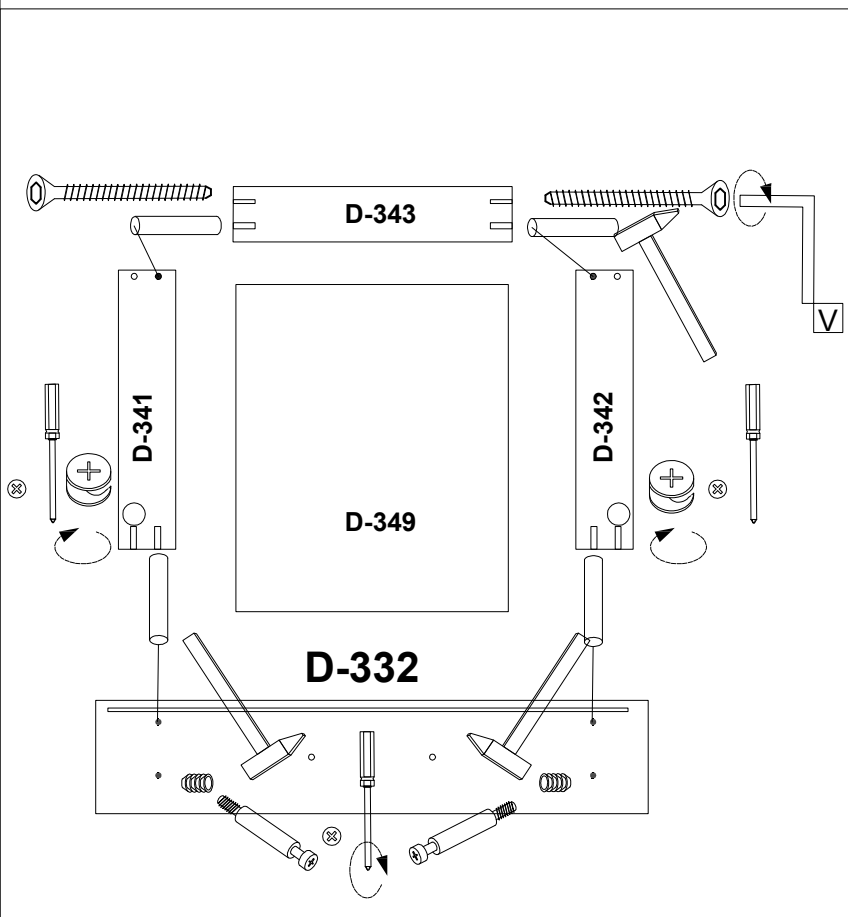
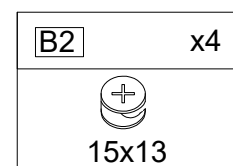



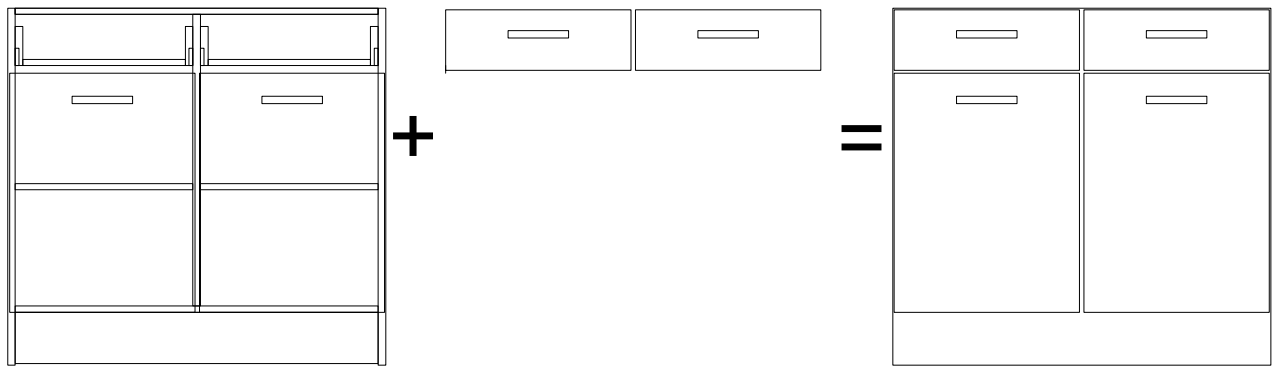

1

2

3

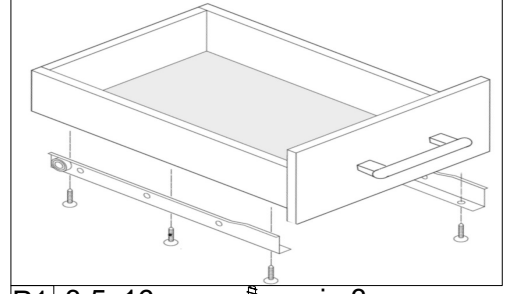
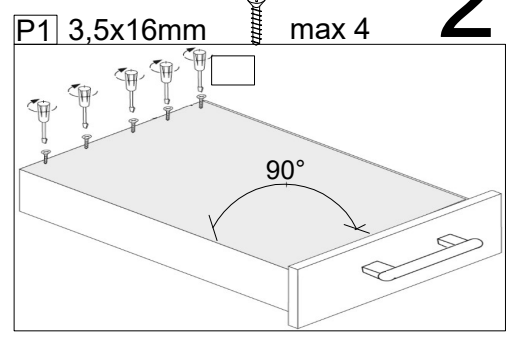
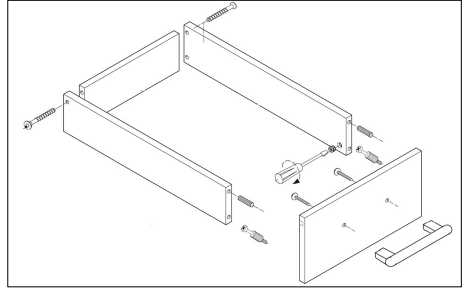

P1 3,5x16mm min 3

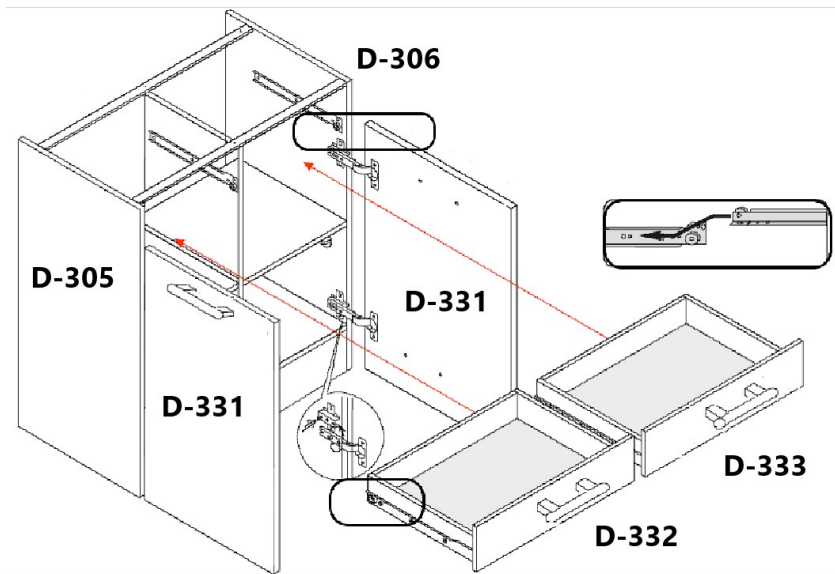

4

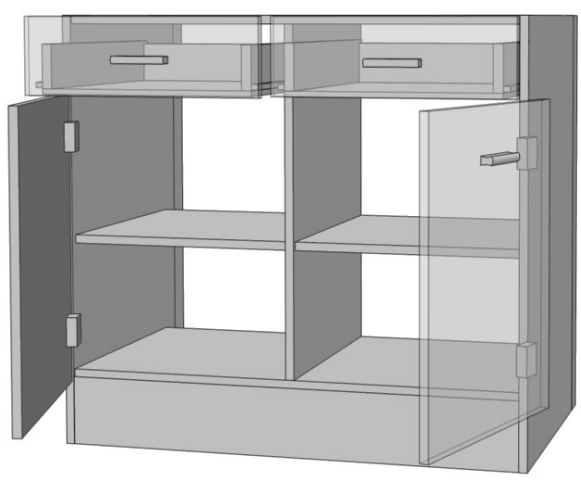
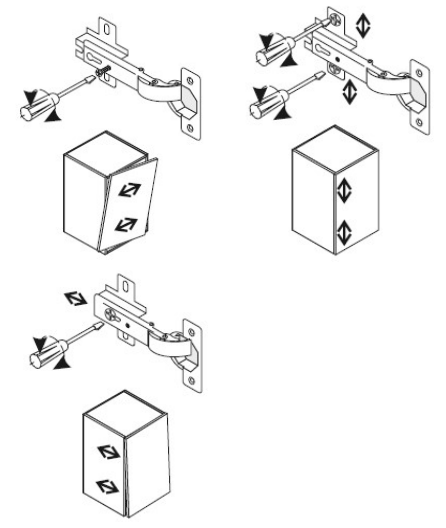

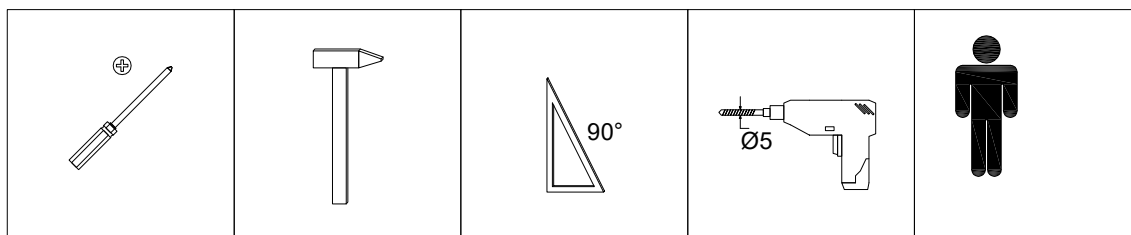
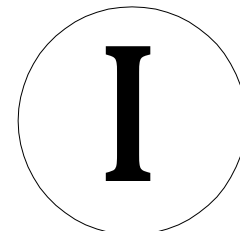
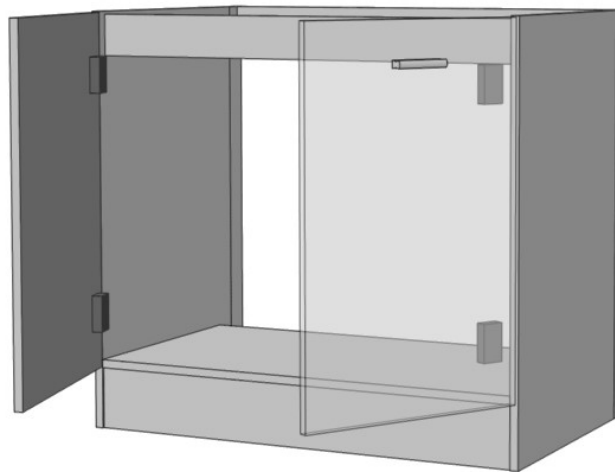
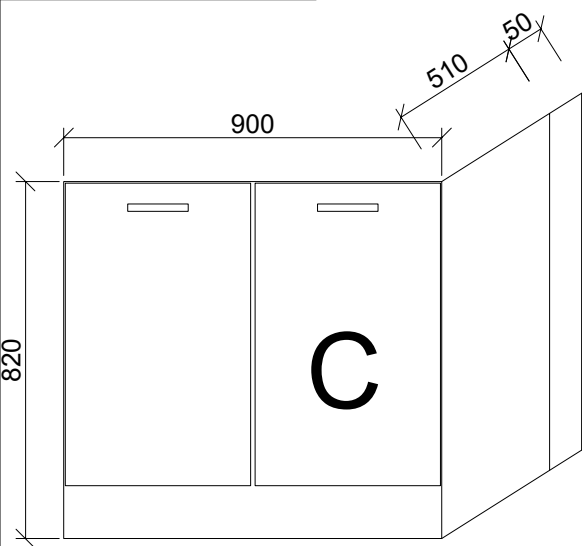

	L	S	
D-303	820	510	1x
D-304	820	510	1x
D-314	868	75	2x
D-317	868	476	1x
D-334	716	446	2x
D-338	868	99	1x

	L	S	
D-348	248	886	1x
D-300	800	50	1x

Kolik drevenny

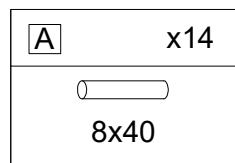

Klinec

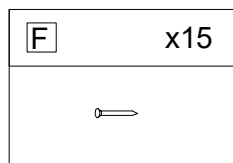

Klizak v=2mm

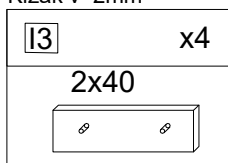

Vrut 3,5x16mm

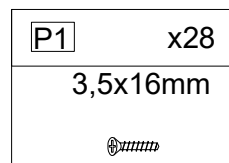

Imbus kluc 4mm

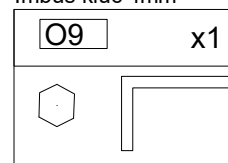

Krytka konfirmat-13mm

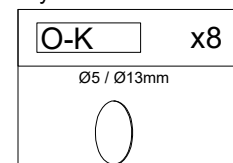

Spojovacia skrutka

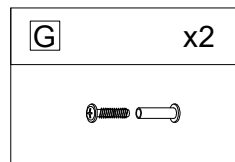

Pant nalozeny

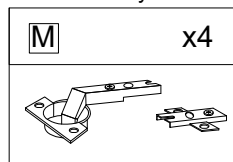

Vrut 3x25mm

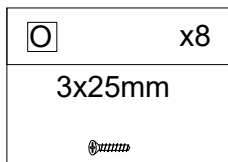

Konfirmat 7x50

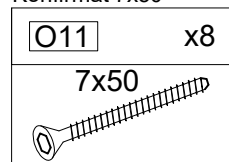

Uchytka - madlo

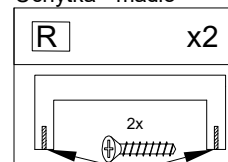

Montážny plech

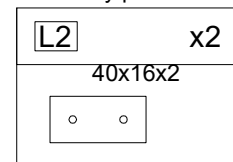

Uholnik kov

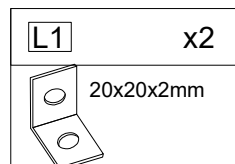

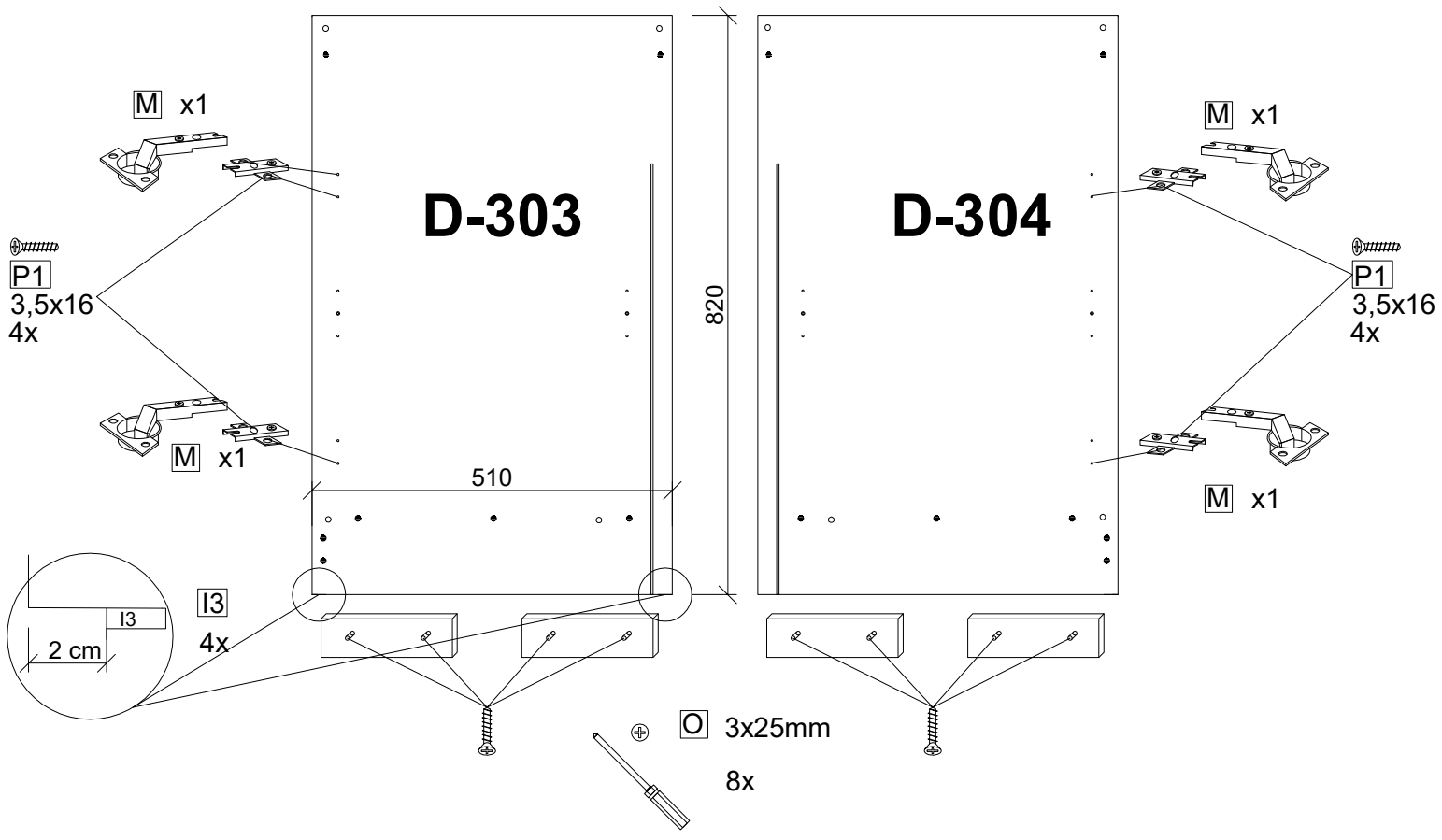
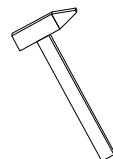
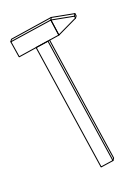
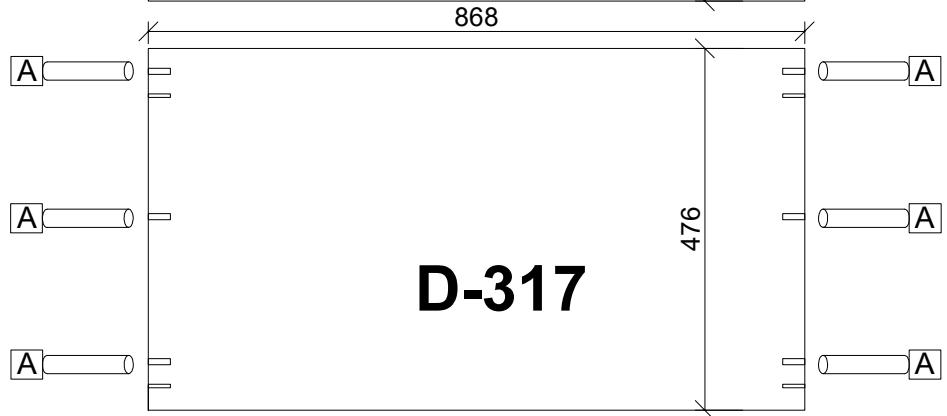
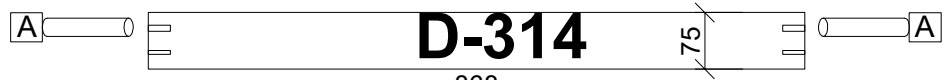
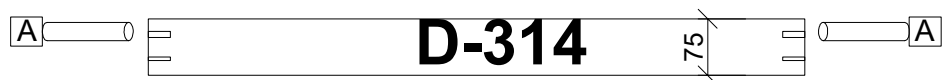
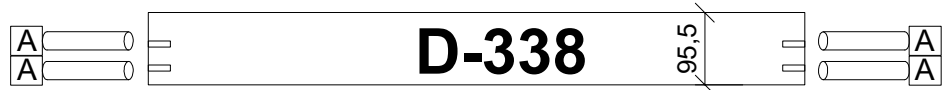
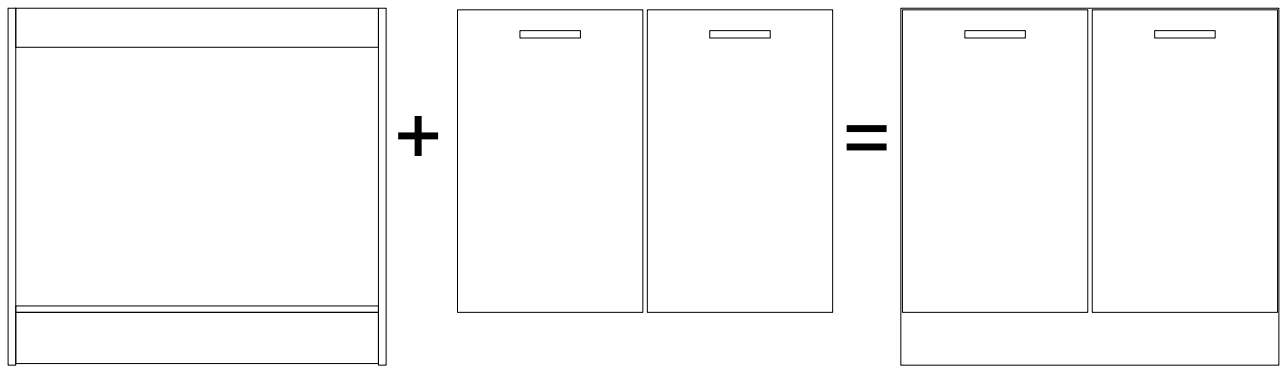

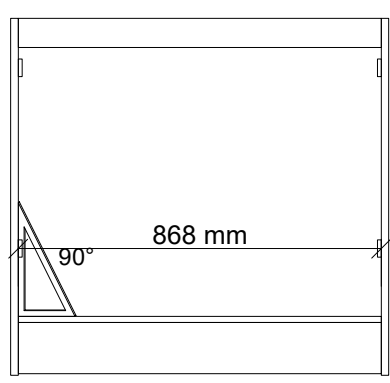
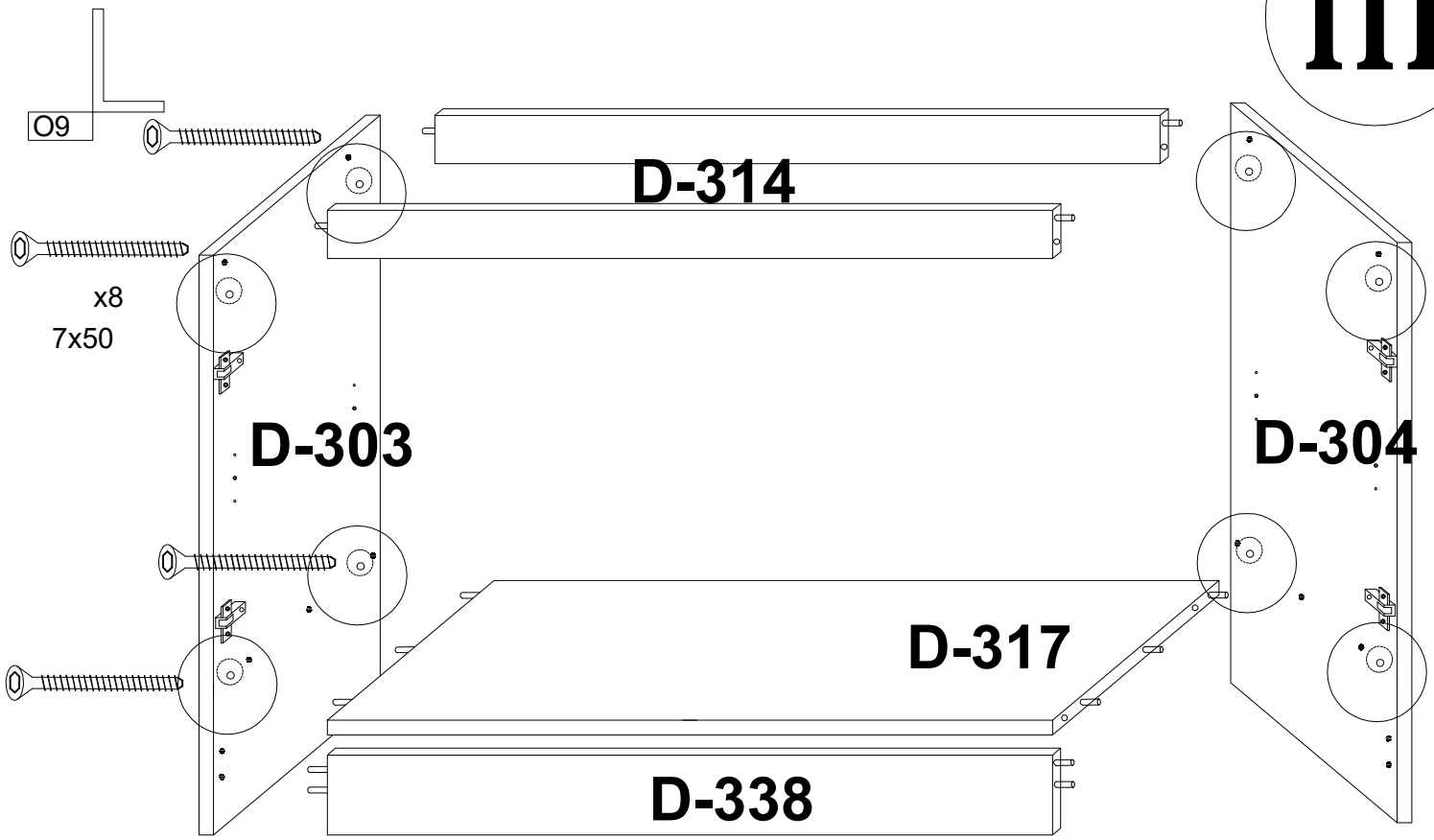

+

**D-348**

=

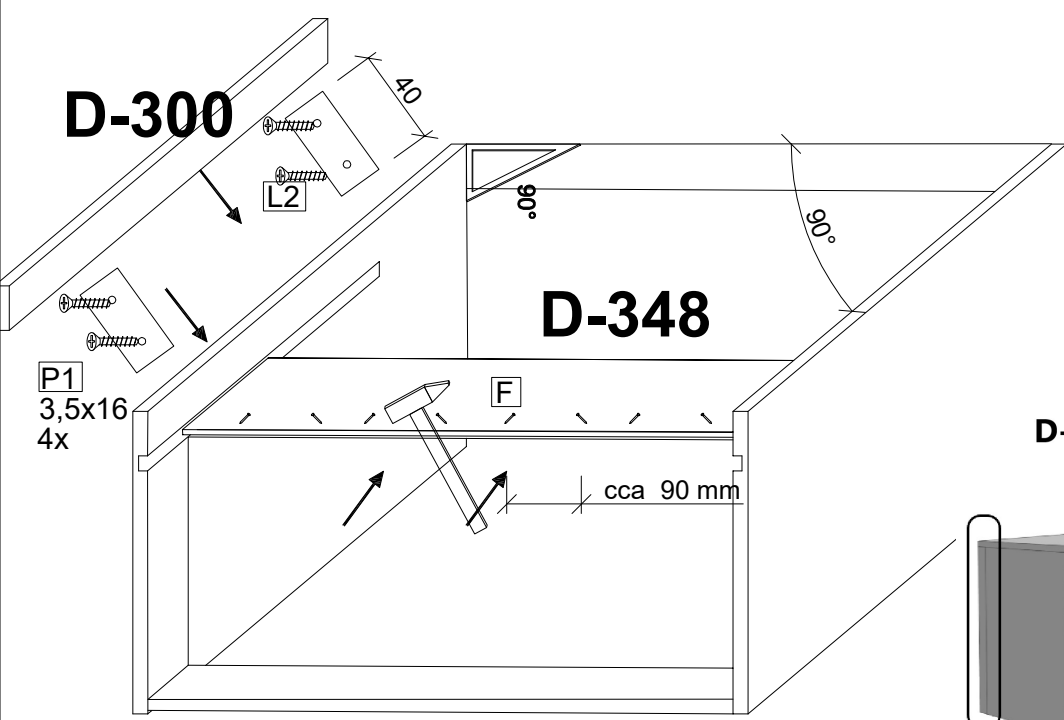
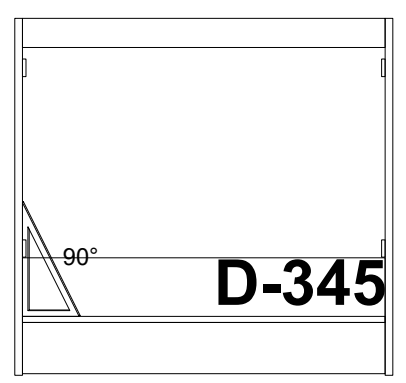

**D-300** len na kraj  
kuchyne

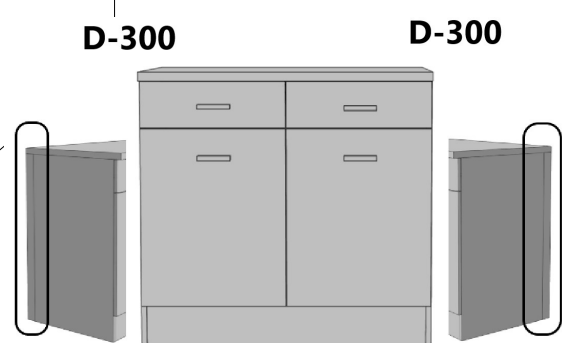

# IV

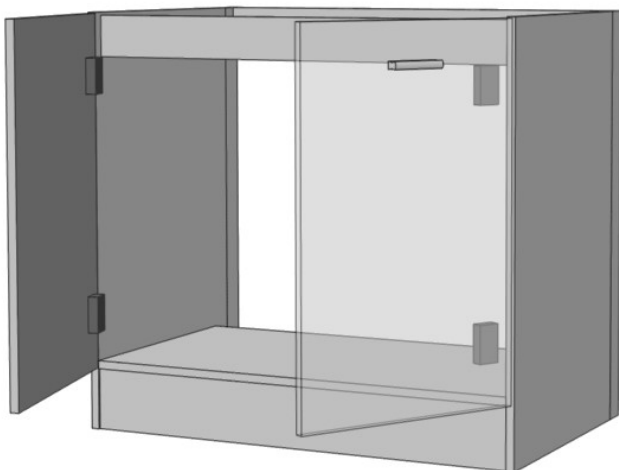
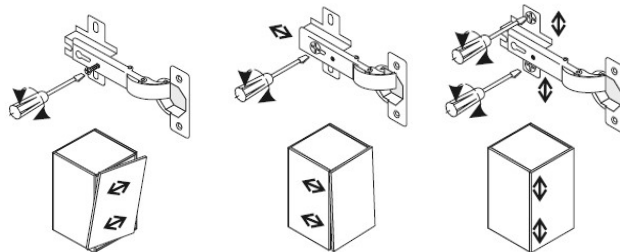
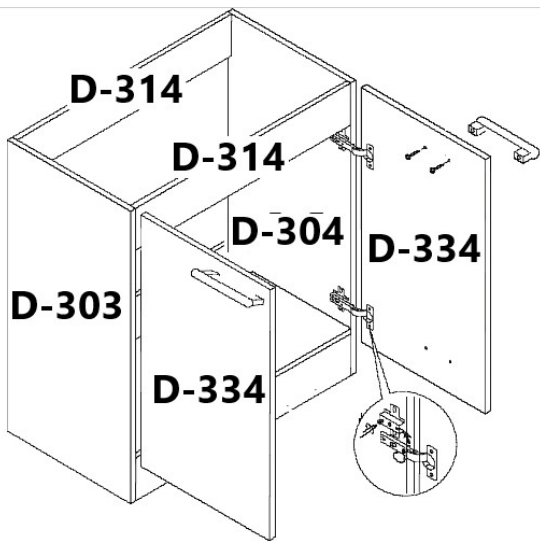
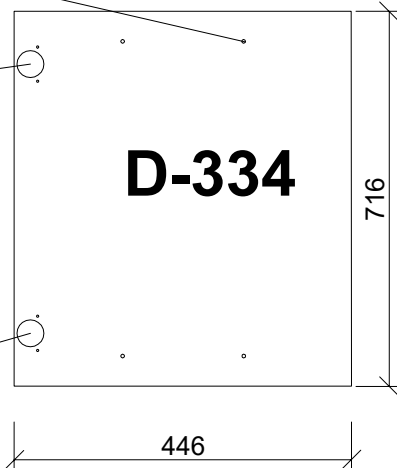
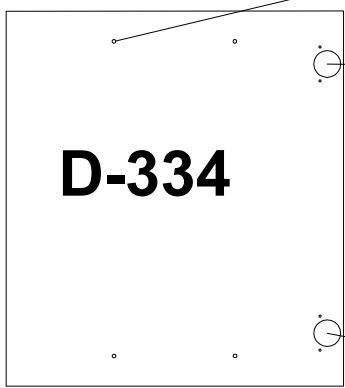
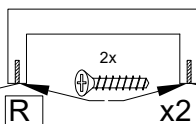
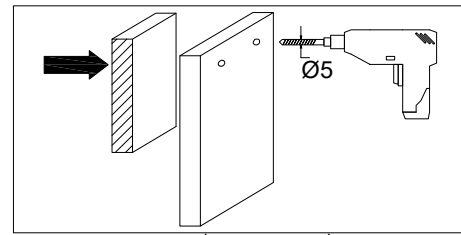
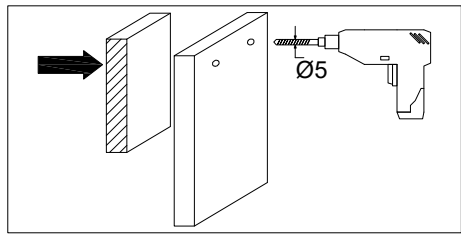

C : 820x900x560

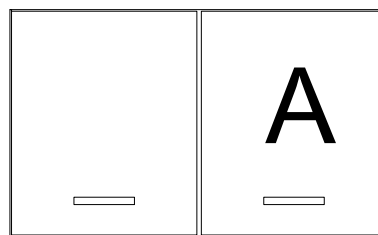
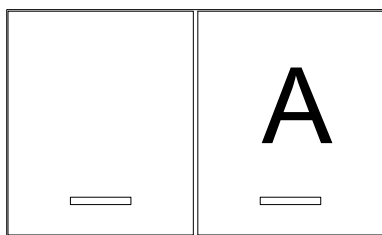
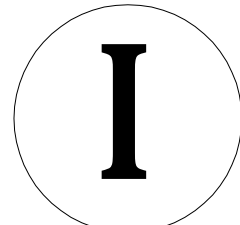

PD

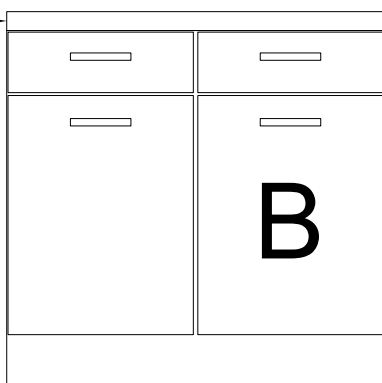

PD

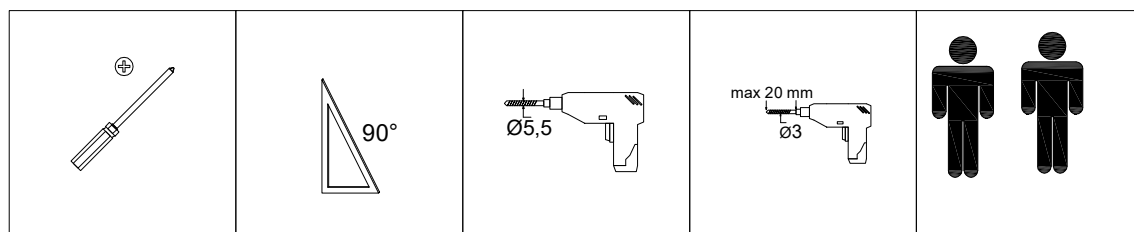
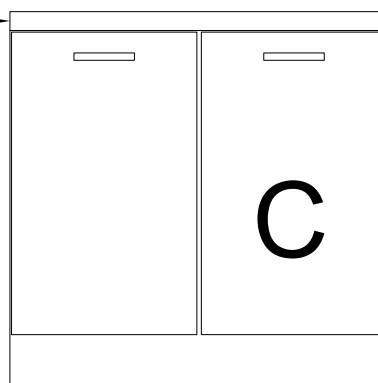

Vrut 3,5x30mm

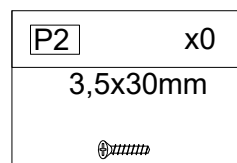

Vrut 3,5x16mm

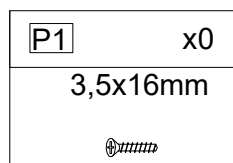

Uholník kov

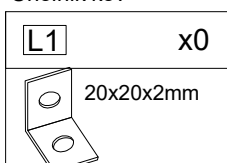

Spojovacia skrutka

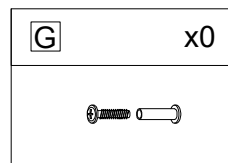

Potrebné kovanie nájdeš vždy v balíku skrinky !!!

Potřebné kování najdeš vždy v balíku skřinky !!!

All items mettal fitting you find in pack off cabinet !!!

# LIGHT 180: Sporak v strede

**LIGHT 240** Kuchynský blok 240 cm : Biela/Sonoma

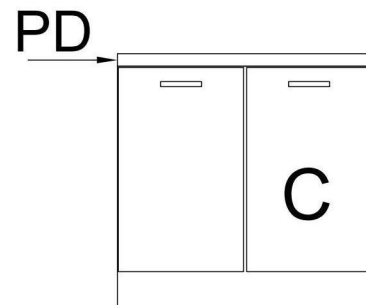
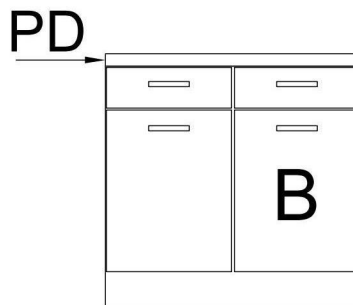
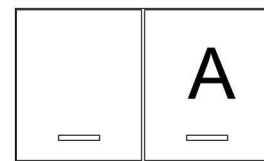
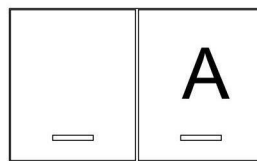
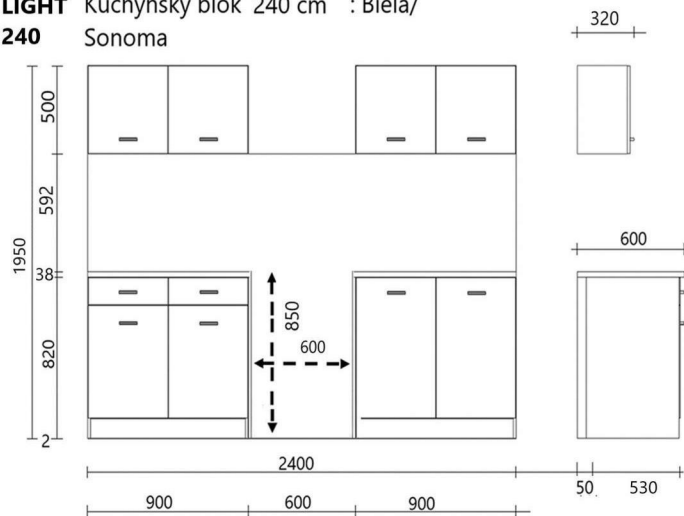

**PD**

**D-351**

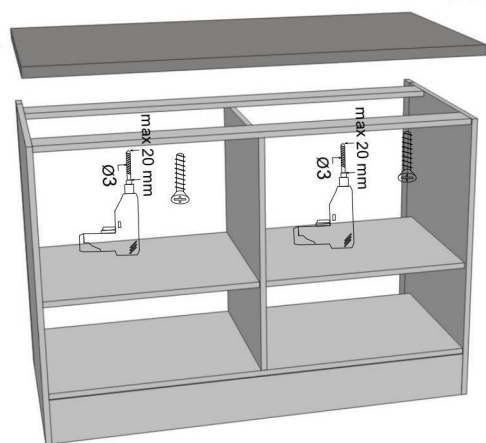

**PD**

**D-351**

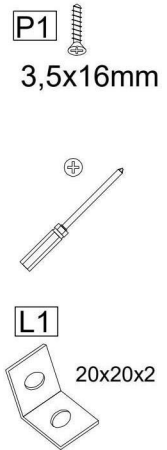
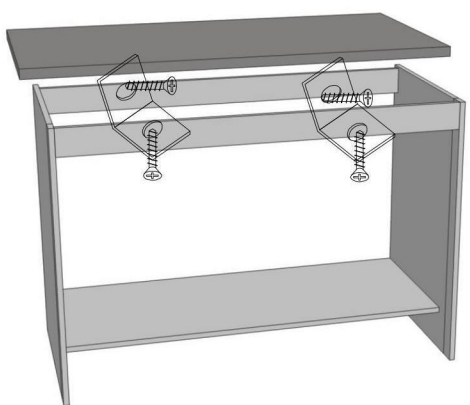



# LIGHT 180: Sporak na kraji

**LIGHT 240** Kuchynský blok 240 cm : Biela/ Sonoma

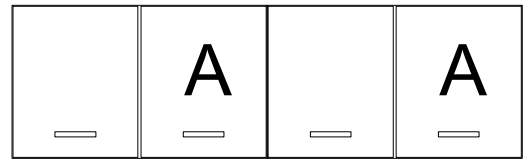
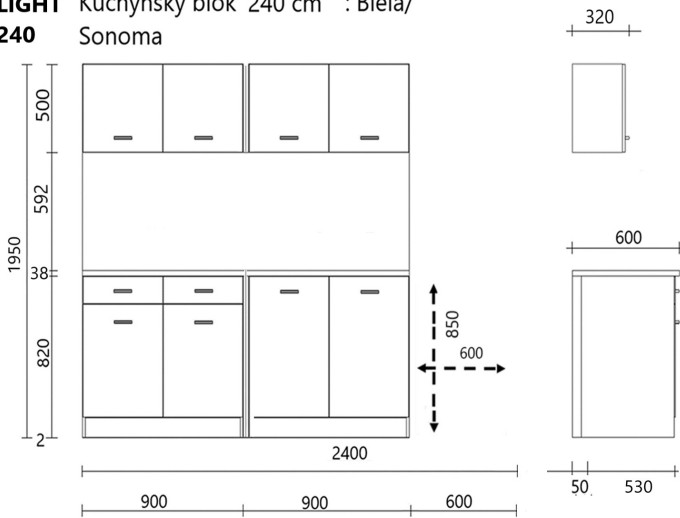

PD

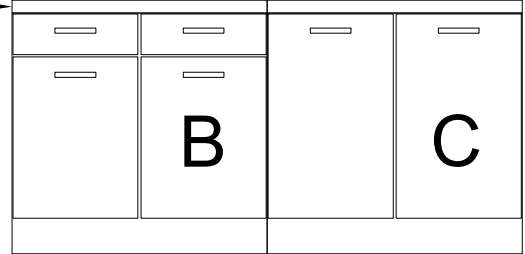

PD

B

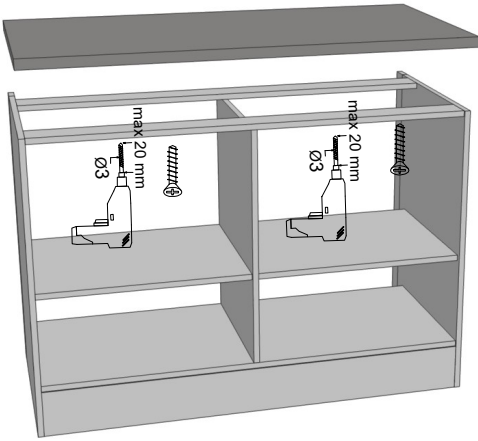

P2 3,5x30mm

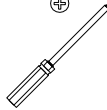

G x2

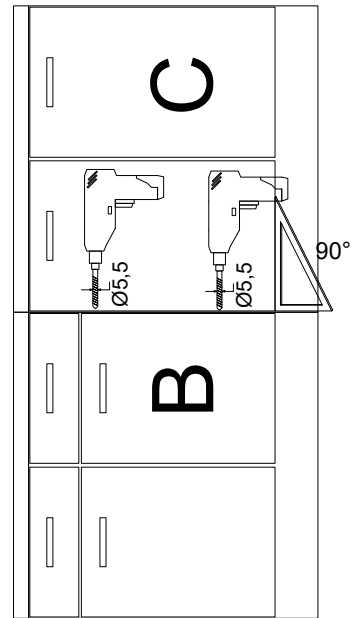

PD

C

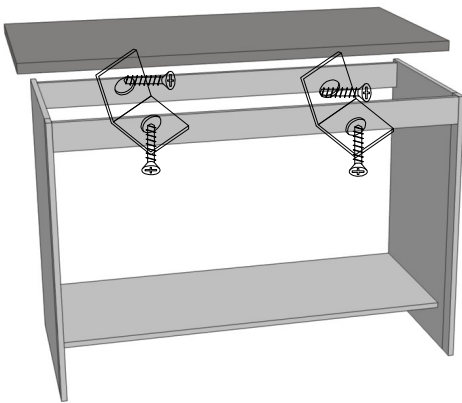

P1 3,5x16mm



L1 20x20x2

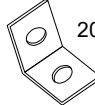

G x2

