

MONTÁŽNÍ/MONTÁŽNY NÁVOD ELIGIA



GB Assembly instructions

PL Instrukcja montażu

DE Montageanleitung

CZ Montážní návod

FR Notice de montage

SK Návod na montáž

NL Handleiding voor de montage

HR Montaže

IT Istruzioni di montaggio

TR Montaj talimat

HU Szerelési útmutató

RO Instrucțiuni de montaj

ES Instrucciones de montaje

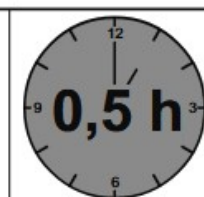
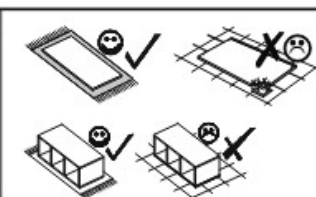
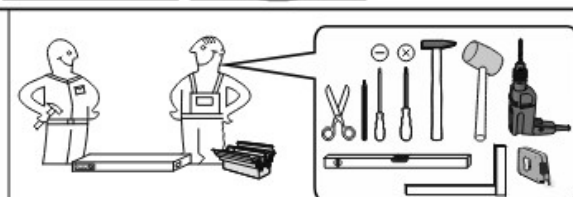
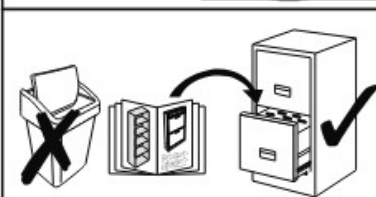
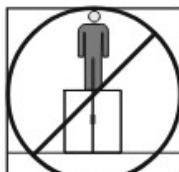
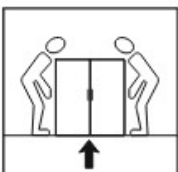
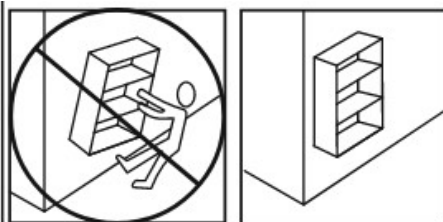
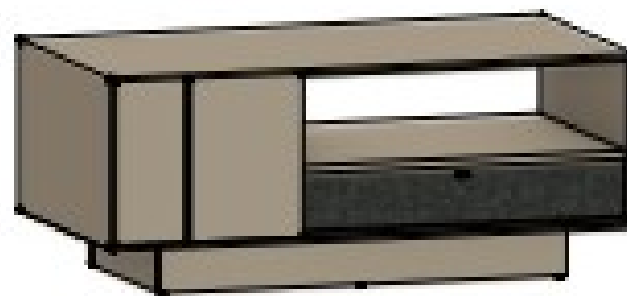

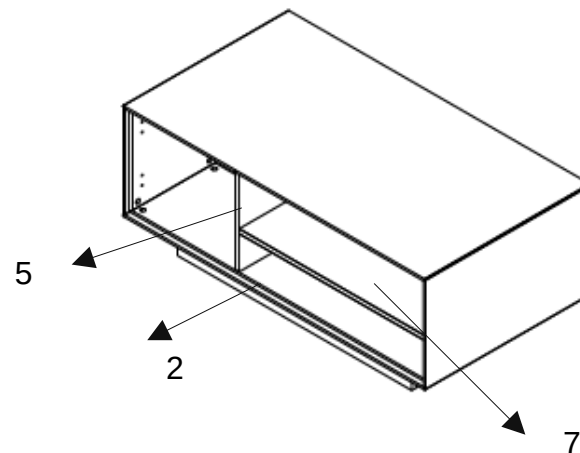
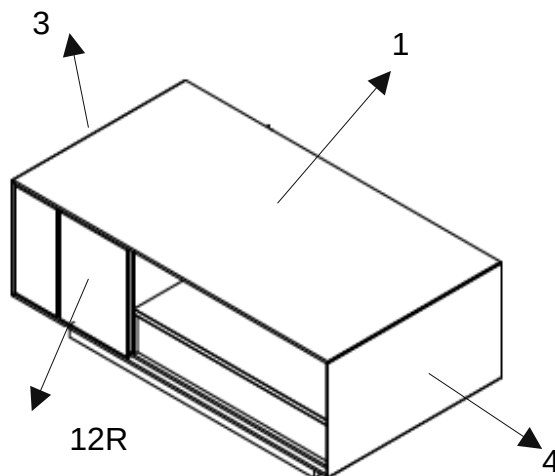
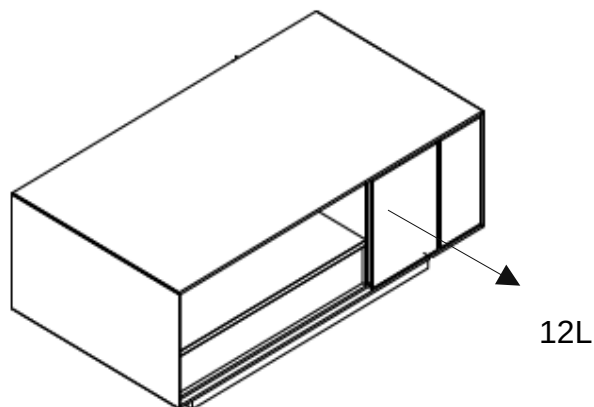
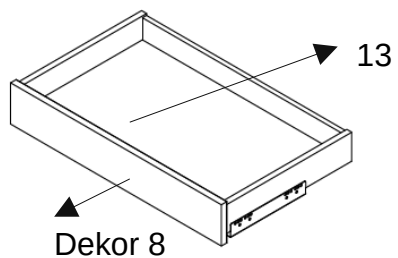



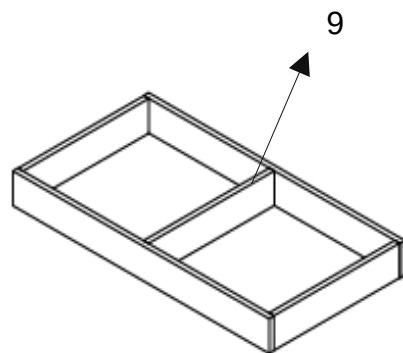















1	1096	600	16
2	1096	600	16
3	346	600	16
4	346	600	16
5	318	562	16
6	372	318	16
7	680	561	16
8	680	120	15
9	850	100	16
10	418	100	16
11	418	100	16
12	328	392	16
13	674	114	18
14	400	80	16
15	640	61	13
16	400	60	16
17	651	404	3



Service • Assistenza • Dienstverlening • Serwis
Servis • Szerviz • Servizio • Usluga •

Name • Nom • Nome • Naam • Nazwa Jméno • Názov • Név • Denumire Nombre • Ime • Isim	COMO	shop • geschäft • boutique • sklep • winkel • negozio • bolt • tienda • obchod • dučan • mađaza • magazin
Nr. • No. • N° • říčišd • Ć • Sz • Ne	23 07 MM 02	
Typ • Type • Tip • Tipus • Tipo	02	

B3	28	 B3	 T2
B1	18	 B1	 311.04.004
T1	12	 T1	 311.71.510
M1	36	 M1	 282.20.715
262.12.859	12	 262.12.859	 MF010.047.P61
S04	36	 S04	 MWI/20
M25	4	433.06.604A 433.06.614A	 M25
W1	8		
MG139.0128/148.P6 1	2	G139.0128/148.P61	
311.04.004	4		J11
311.71.510	4	 W1	 S4

