

1	1X
2	1X
3	1X

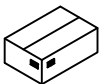

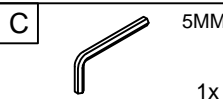

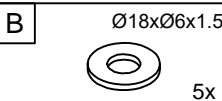
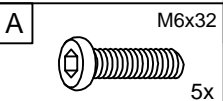

1/1

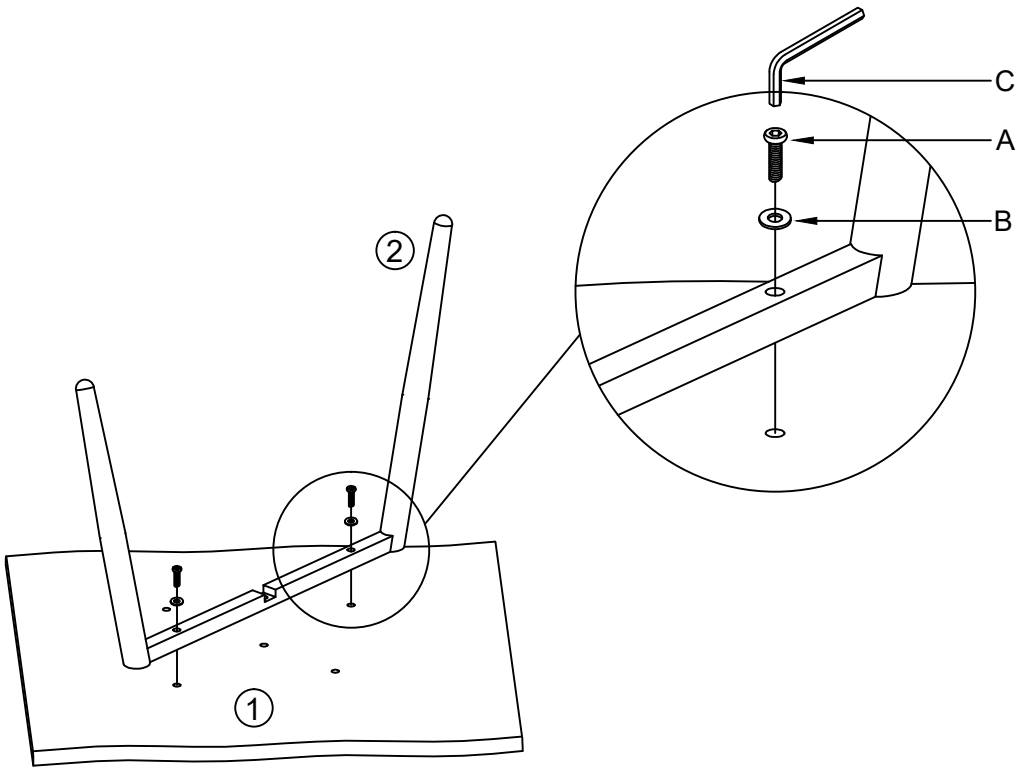

I.

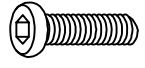



1

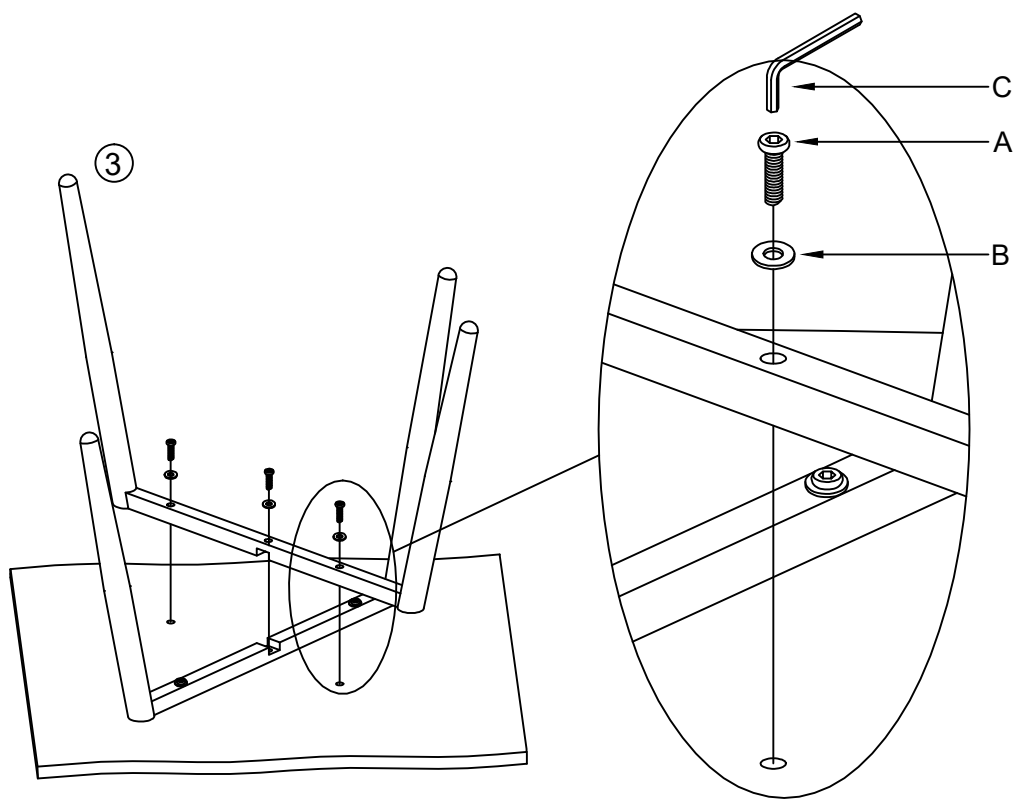

- A** M6x32
 2x
- B** Ø18xØ6x1.5
 2x
- C** 5MM
 1x
-  75%

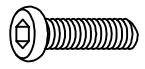
2



- A** M6x32
 3x
- B** Ø18xØ6x1.5
 3x
- C** 5MM
 1x
-  100%

II.

3

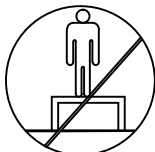
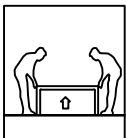
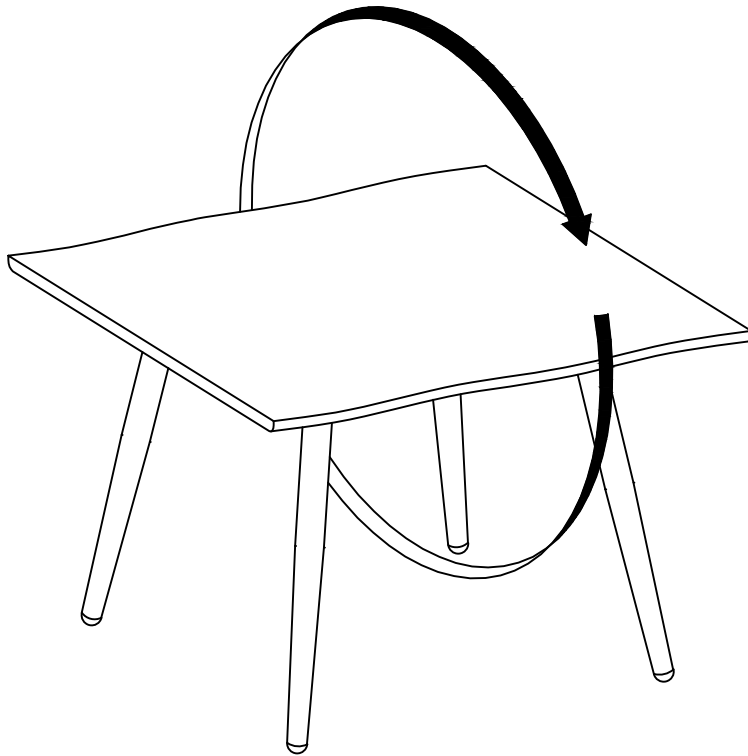
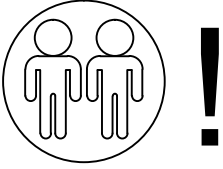

Séparez les éléments avant de trier