

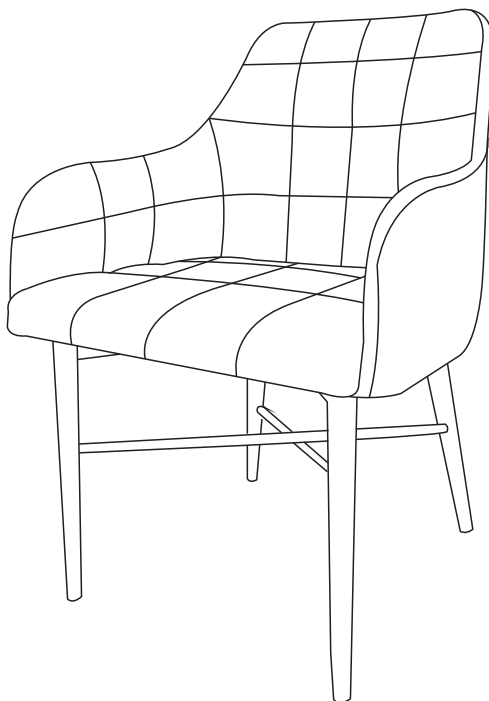







NÁVOD NA MONTÁŽ

AC-9990

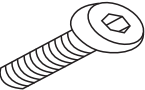
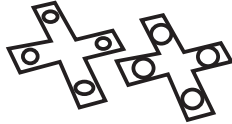
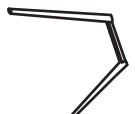
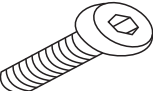

SEZNAM DÍLŮ:

| | | | | | | | |
|---|----|---|----|--|----|---|----|
| A | X1 | D | X4 | G | X4 | J | X1 |
|  | |  | |  | |  | |
| B | X1 | E | X4 | H | X2 | | |
|  | |  | |  | | | |
| C | X1 | F | X4 | I | X1 | | |
|  | |  | |  | | | |

1

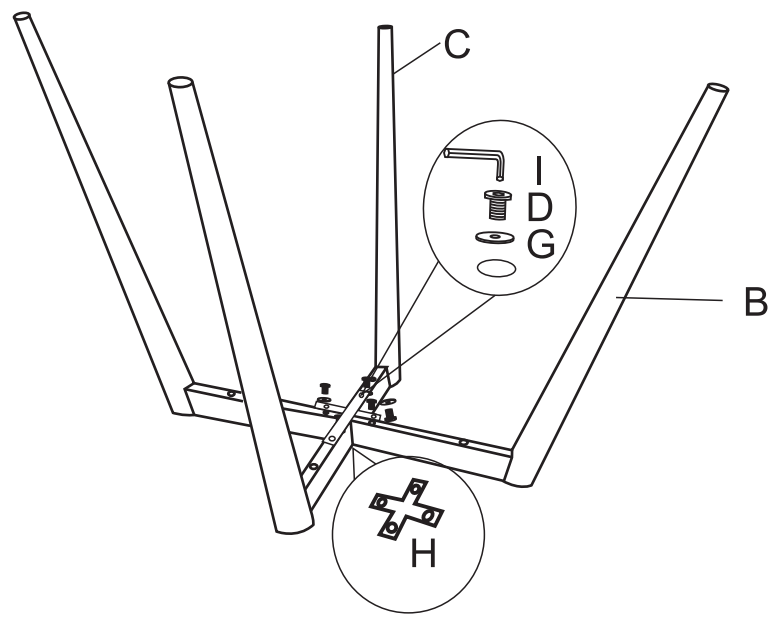

2

