

# MONTÁŽNÍ/MONTÁŽNY NÁVOD ADEL

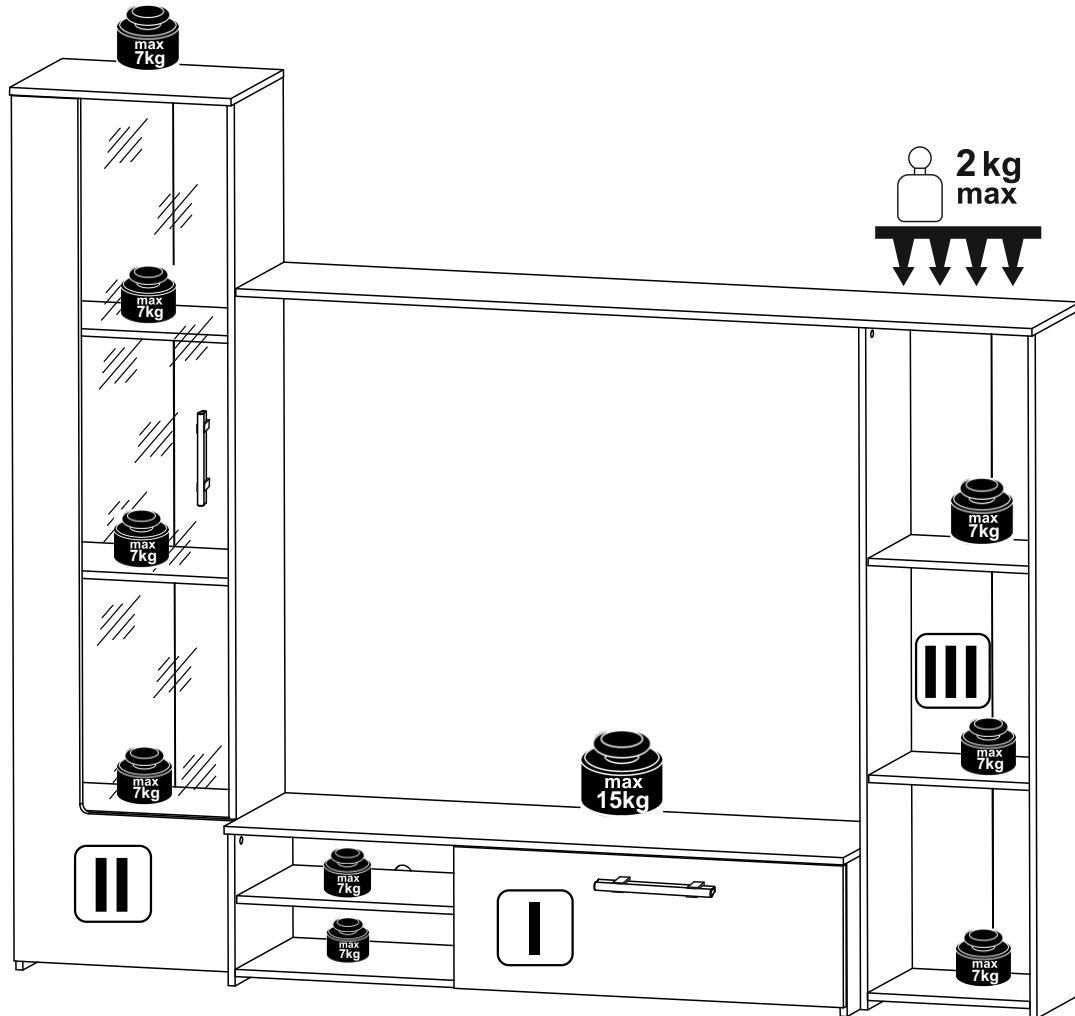

6x K0  <b>a44</b>	6x  <b>b19</b>	32x  φ15x12mm #16 <b>r1</b>	32x  20/9 <b>r16</b>	20x  φ16 <b>s2</b>	130x  <b>l1</b>
2x  φ4x30 mm <b>p9</b>	20x  φ5x17 mm <b>d1</b>	8x  φ3,5x16 mm <b>p38</b>	2x  φ7x50 mm <b>e1</b>	29x  φ8x30 mm <b>f1</b>	2x  <b>c813</b>
12x  φ3,5x15 mm <b>p51</b>	8x  φ3,5x13 mm <b>p1</b>	2x  L-230 <b>m48</b>	1x  <b>z1</b>	2x  φ4x20 mm <b>p39</b>	2x  <b>n261</b>
8x  <b>o1</b>	1x  60x60x25 mm <b>k55</b>	2x  φ4x35 mm <b>p6</b>	12x  <b>k1</b>	4x  M4x12 mm <b>j4511</b>	2x  φ5\M4x23 mm <b>j4512</b>

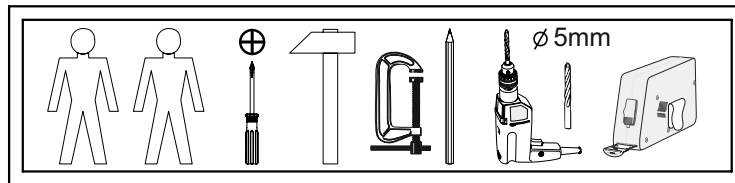
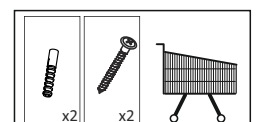

# I

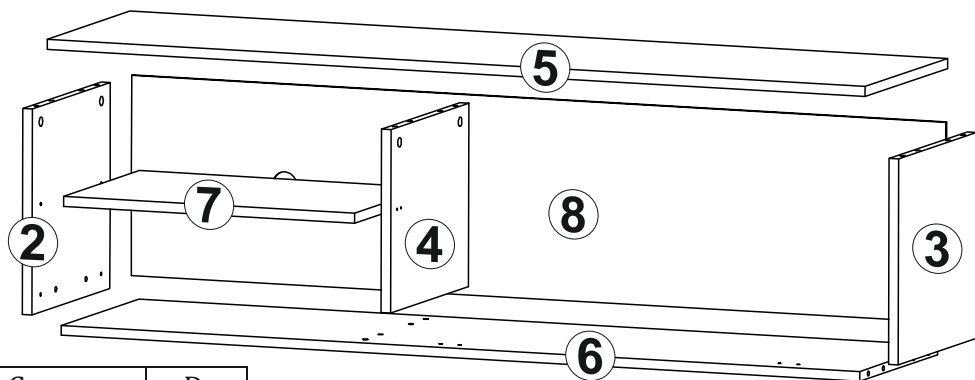

A	B	C	D	
1	AD2-001	880	305	2/3
2	AD2-101	330	330	2/3
3	AD2-102	330	330	2/3
4	AD2-103	294	330	2/3
5	AD2-201	1400	350	1/3
6	AD2-301	1367	330	2/3
7	AD2-302	498	320	2/3
8	AD2-901	1394	321	1/3

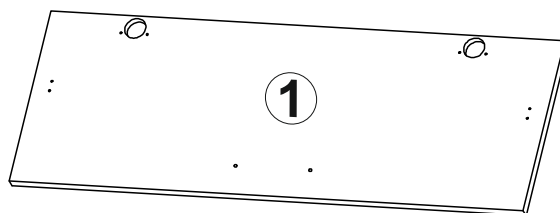

# 1

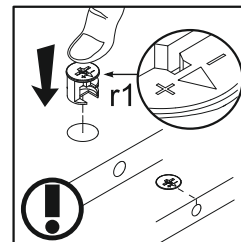
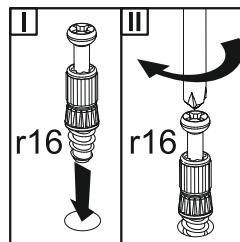
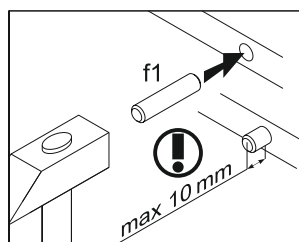
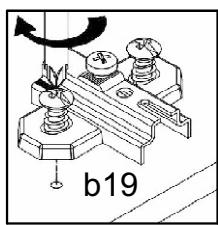
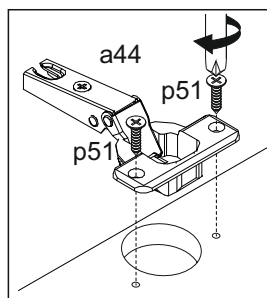
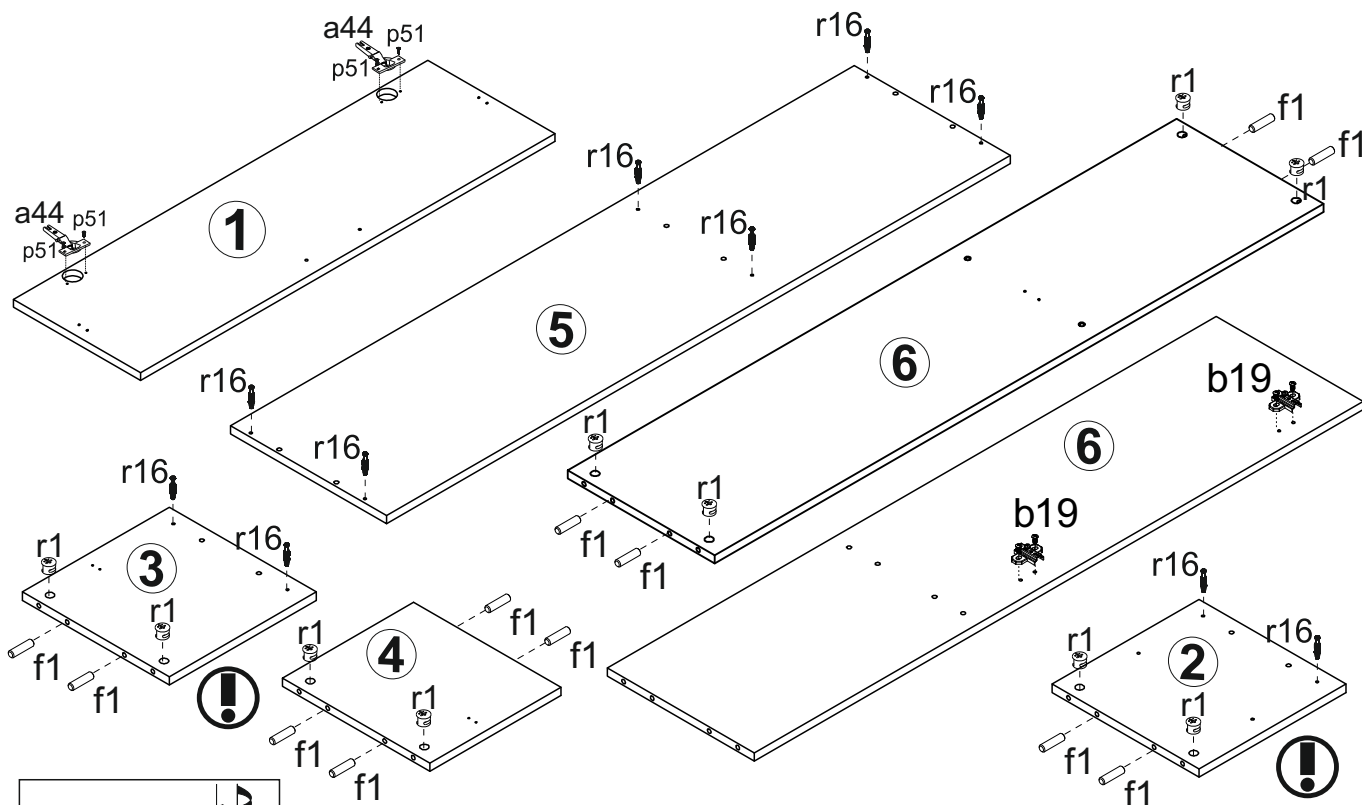
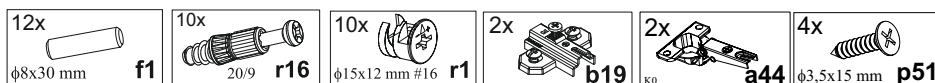

# 2

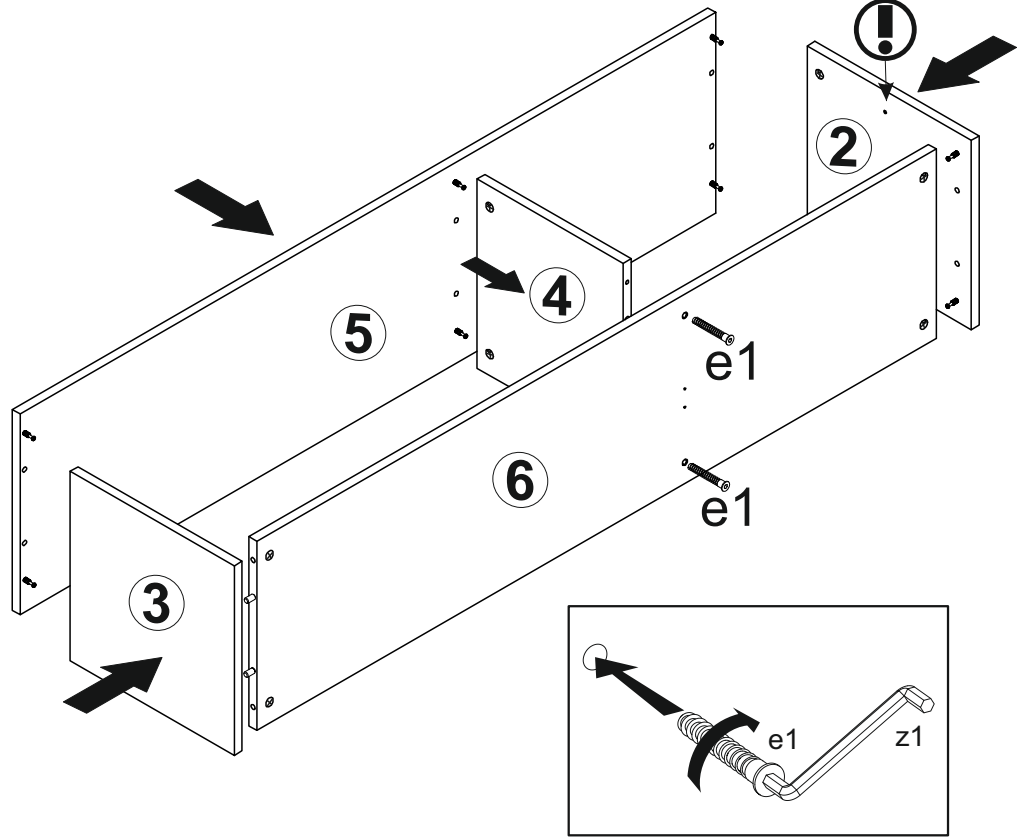
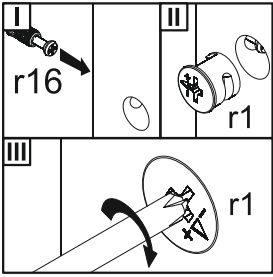

# 3

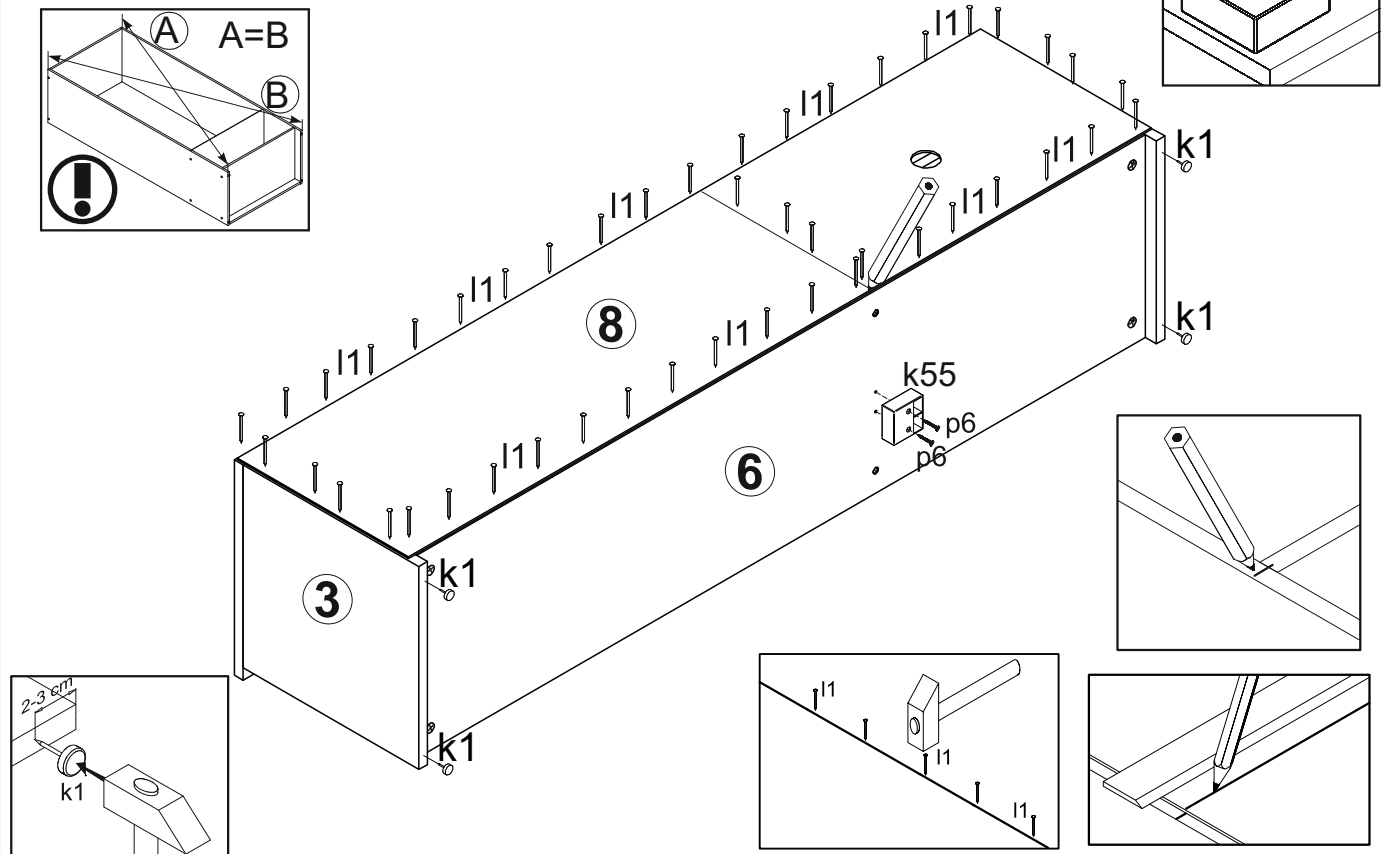
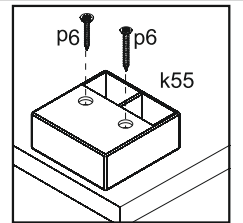
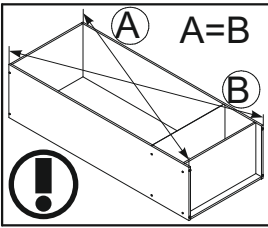
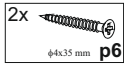
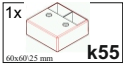
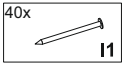

# 4

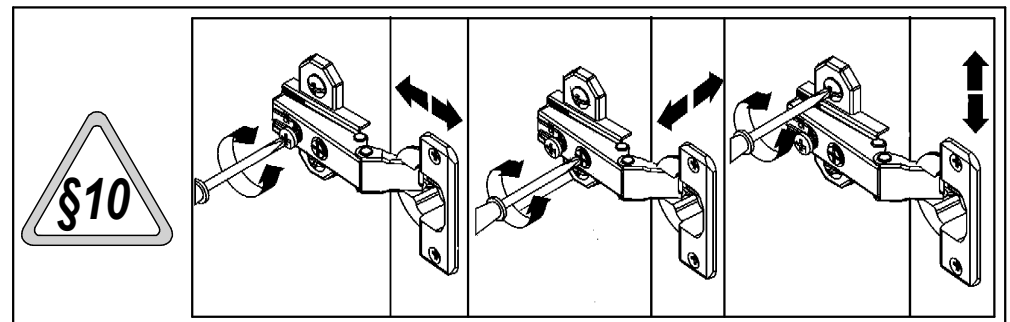
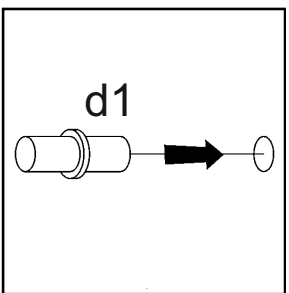
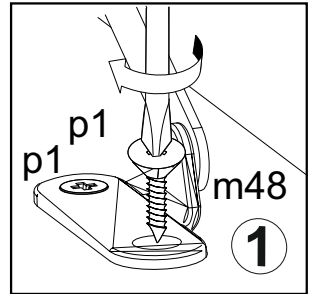
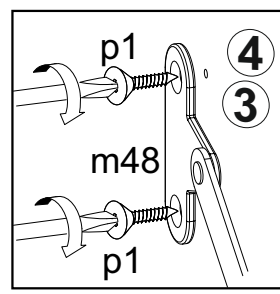
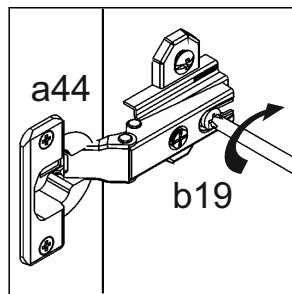
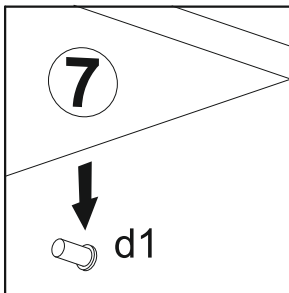
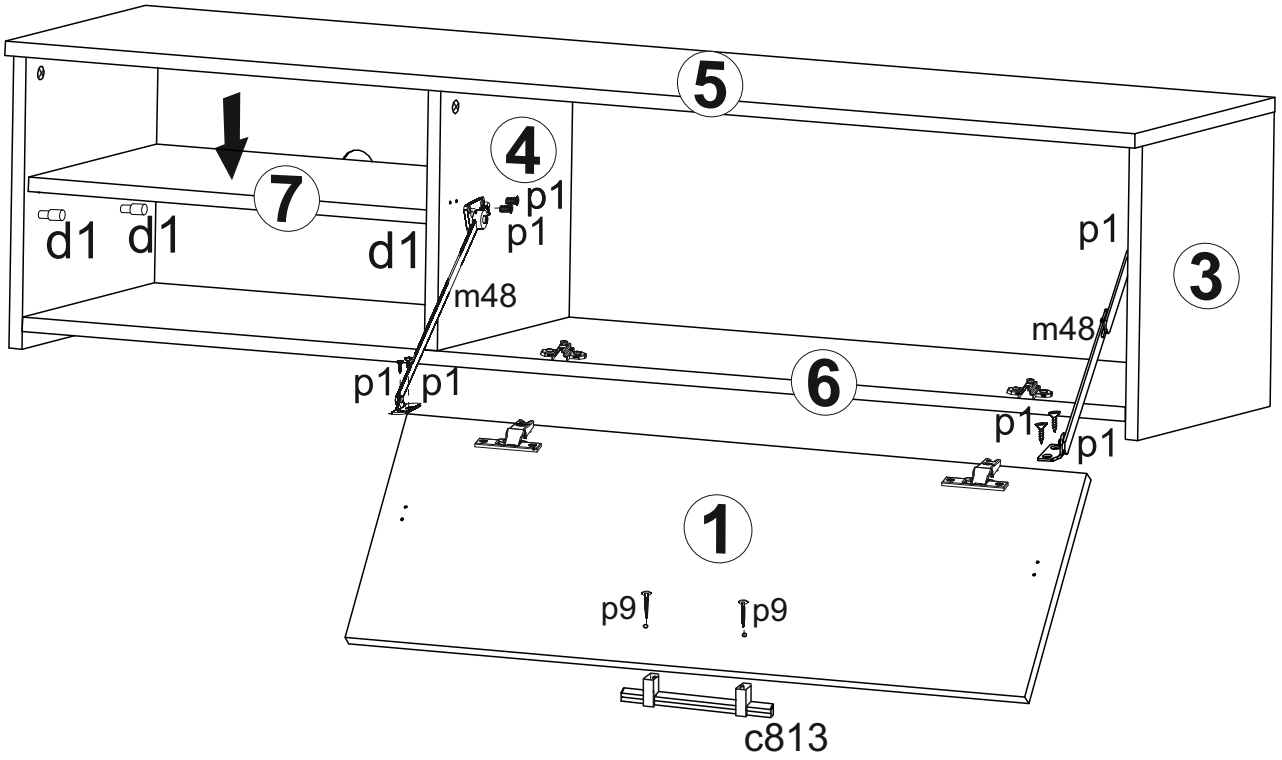
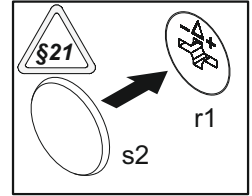
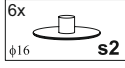
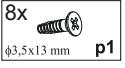
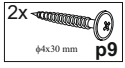
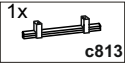
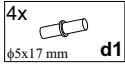



A	B	C		D
1	AD2-002	1860	495	1/3
2	AD2-501	1565	358	3/3
3	AD2-104	1884	280	1/3
4	AD2-105	1884	280	1/3
5	AD2-202	500	300	2/3
6	AD2-303	467	280	1/3
7	AD2-305	467	275	1/3
8	AD2-304	467	265	1/3
9	AD2-902	1875	247	1/3
10	LH-1847	1847		1/3

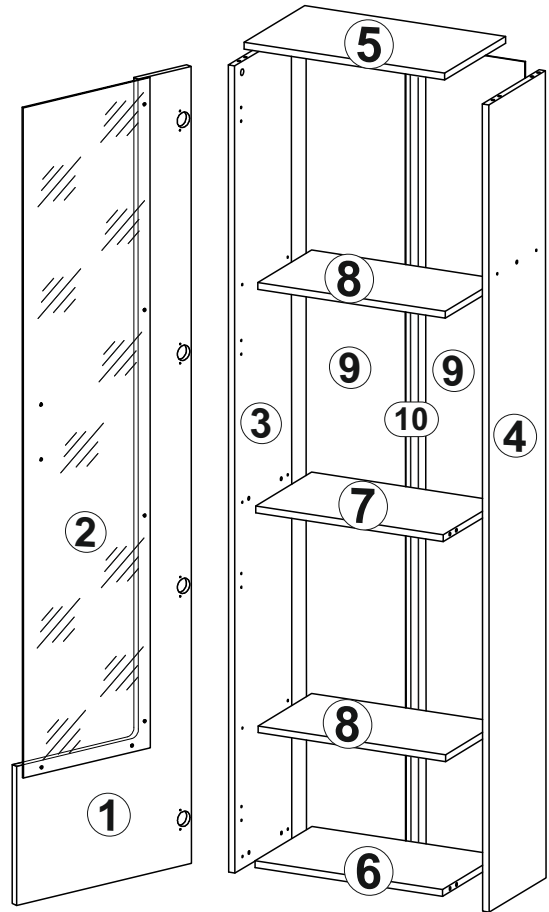

**1**

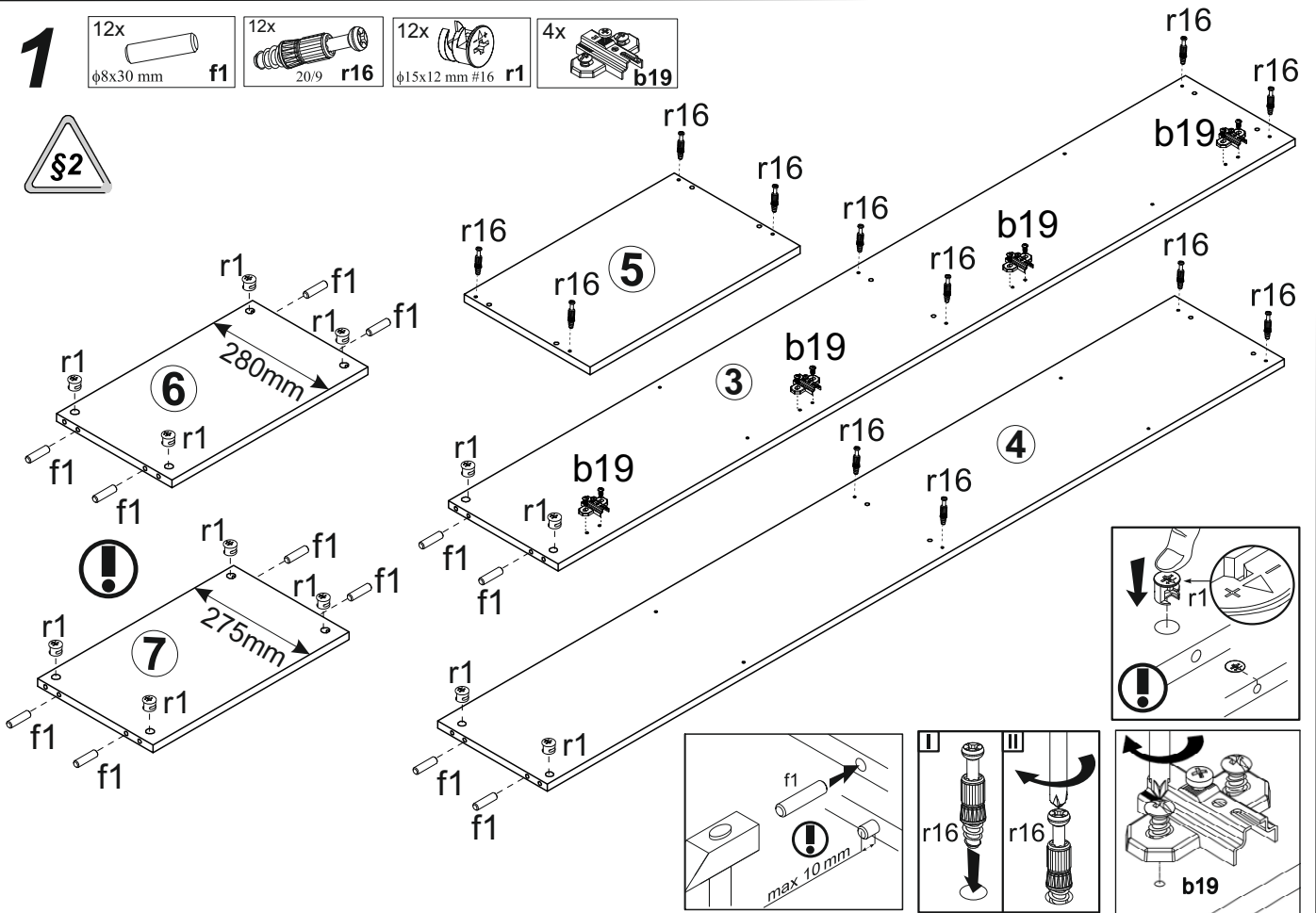
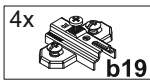
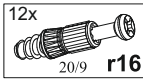
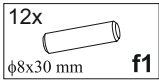

# 2

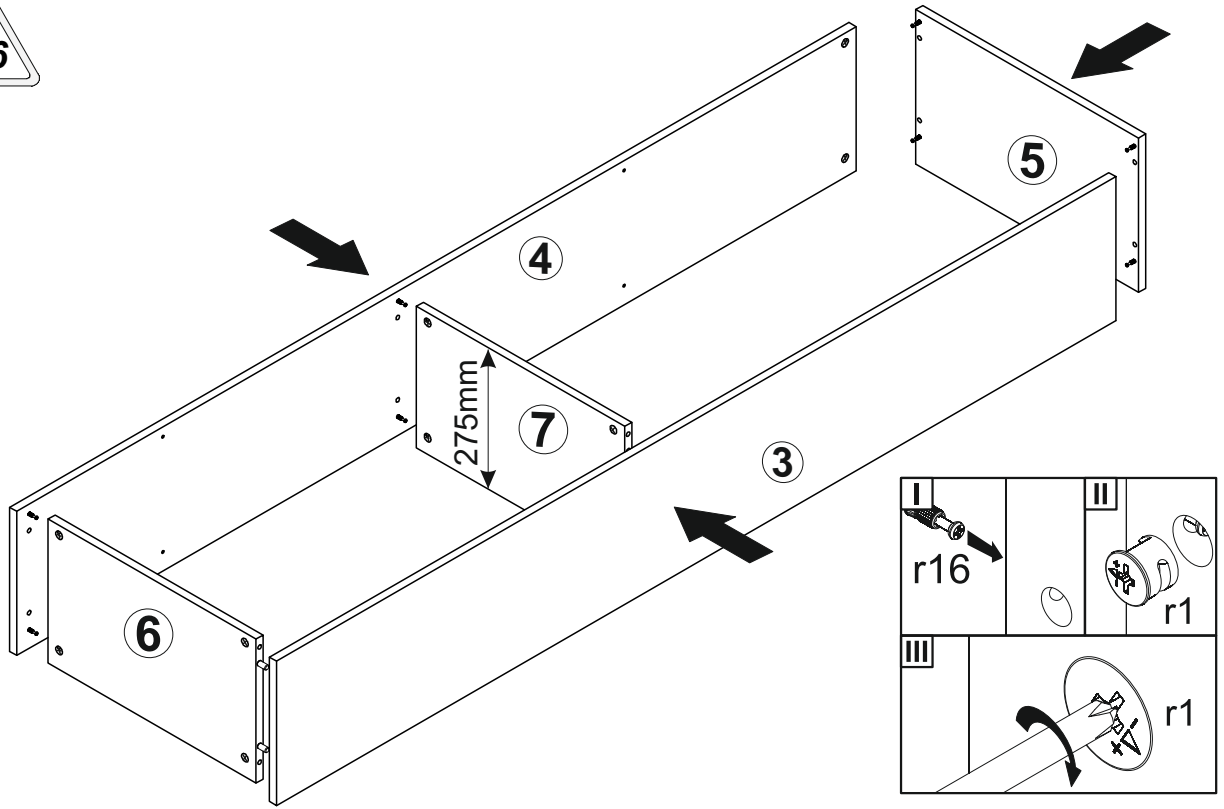

# 3

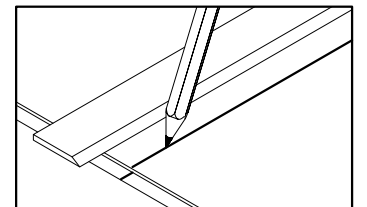
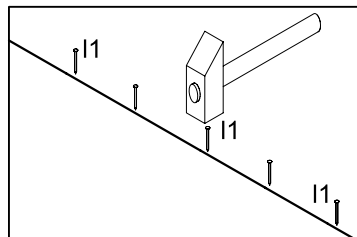
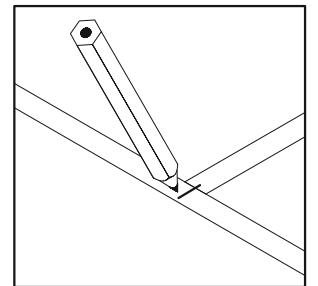
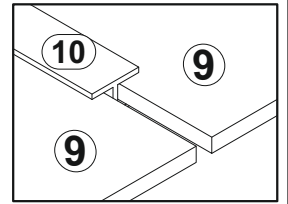
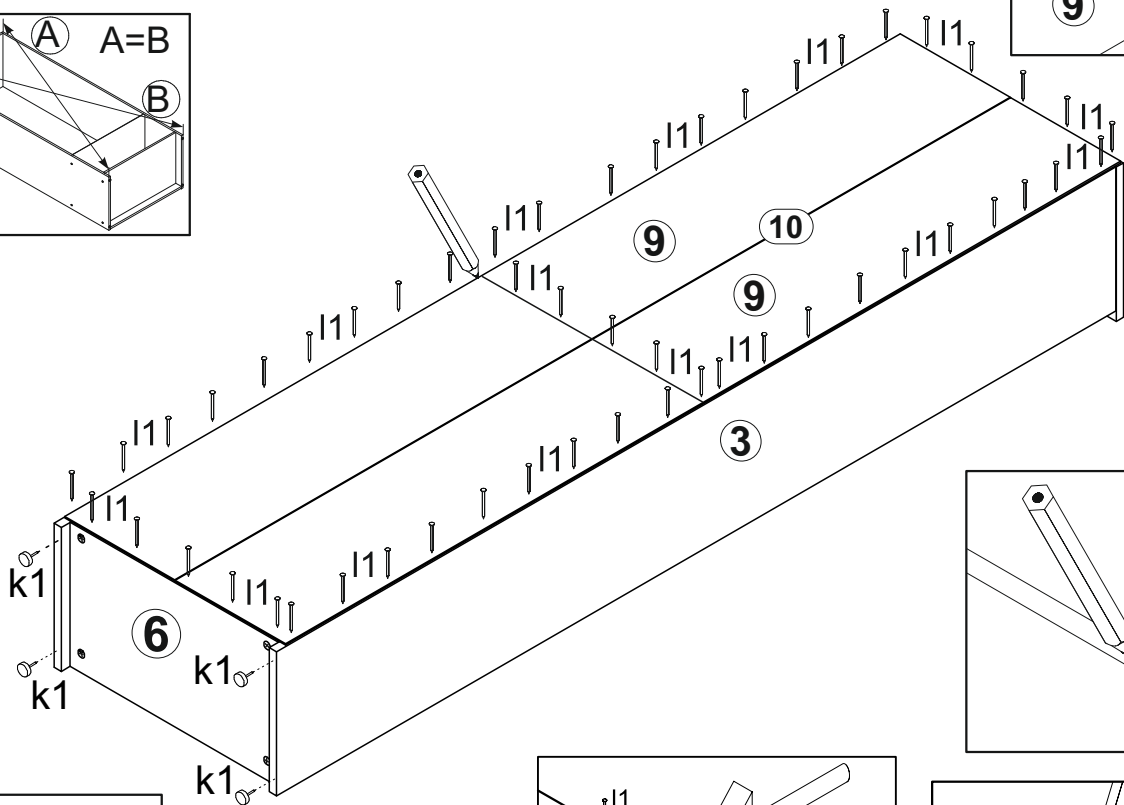
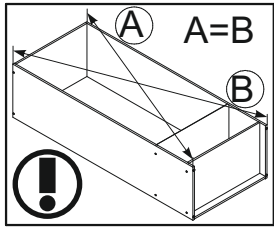
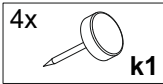
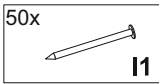

# 4

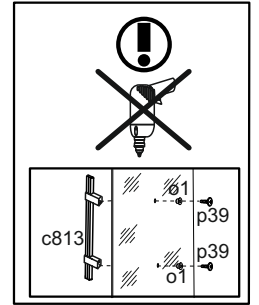
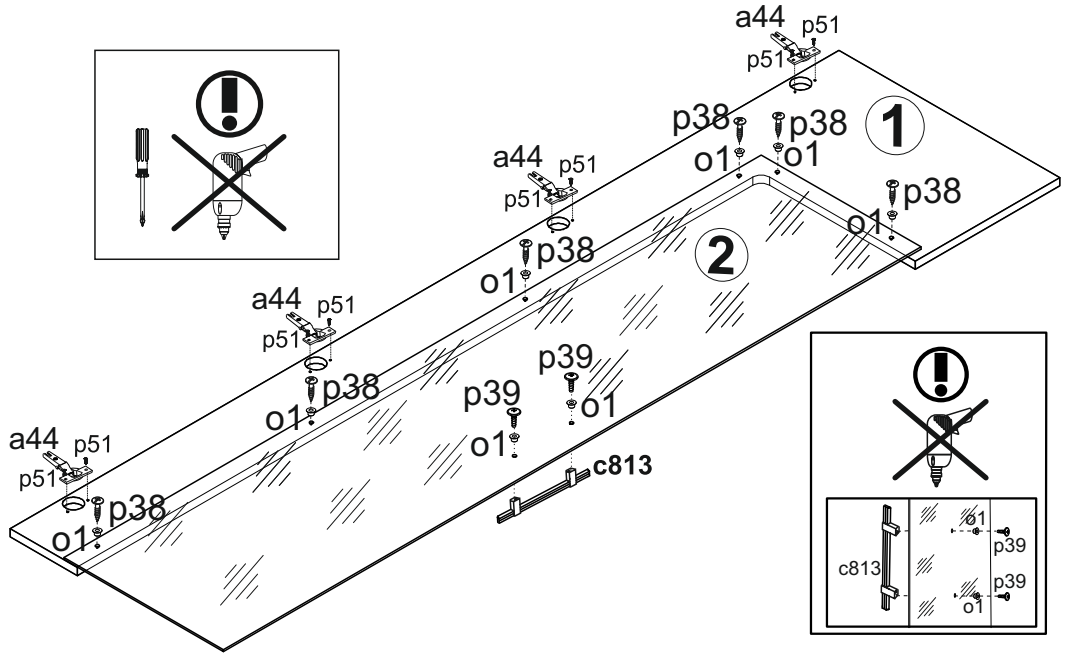
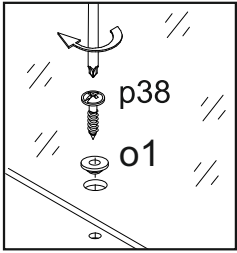
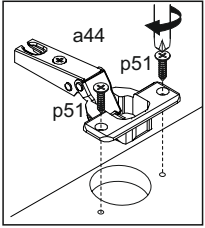
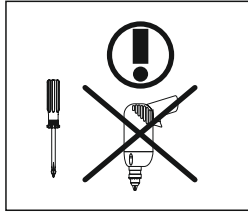
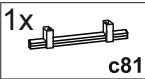
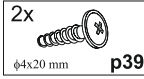
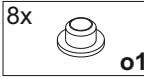
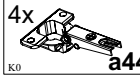

# 5

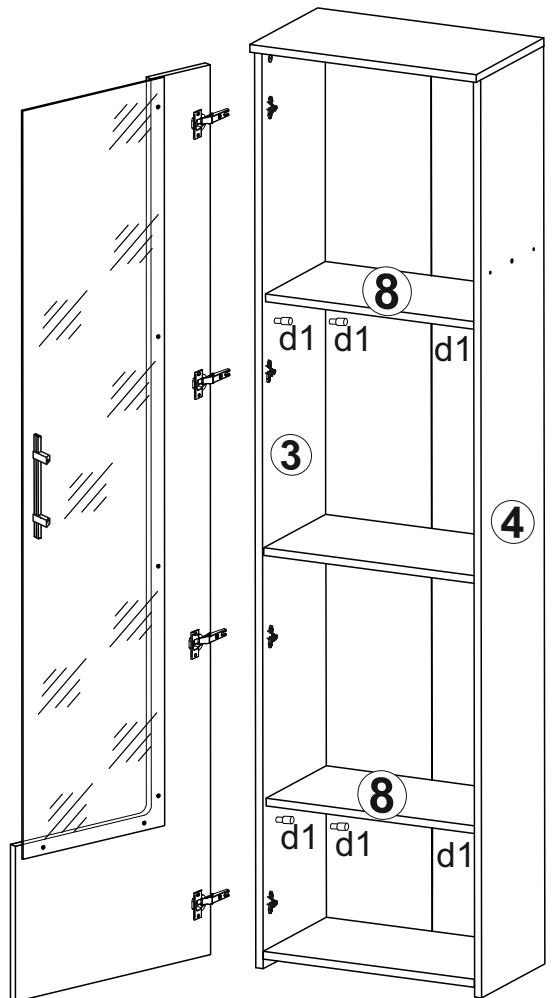
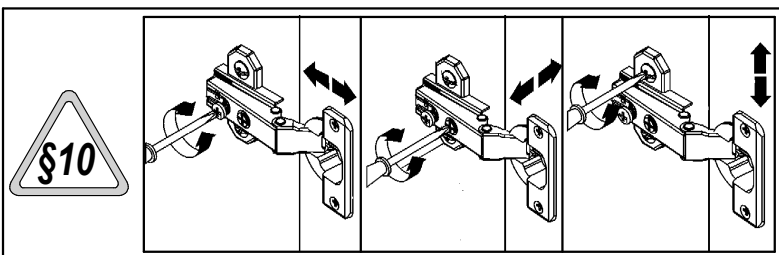
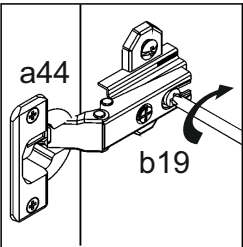
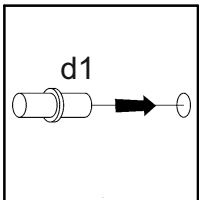
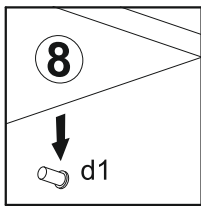
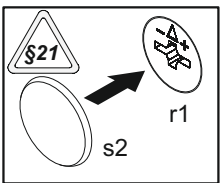
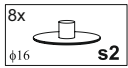
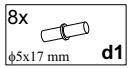

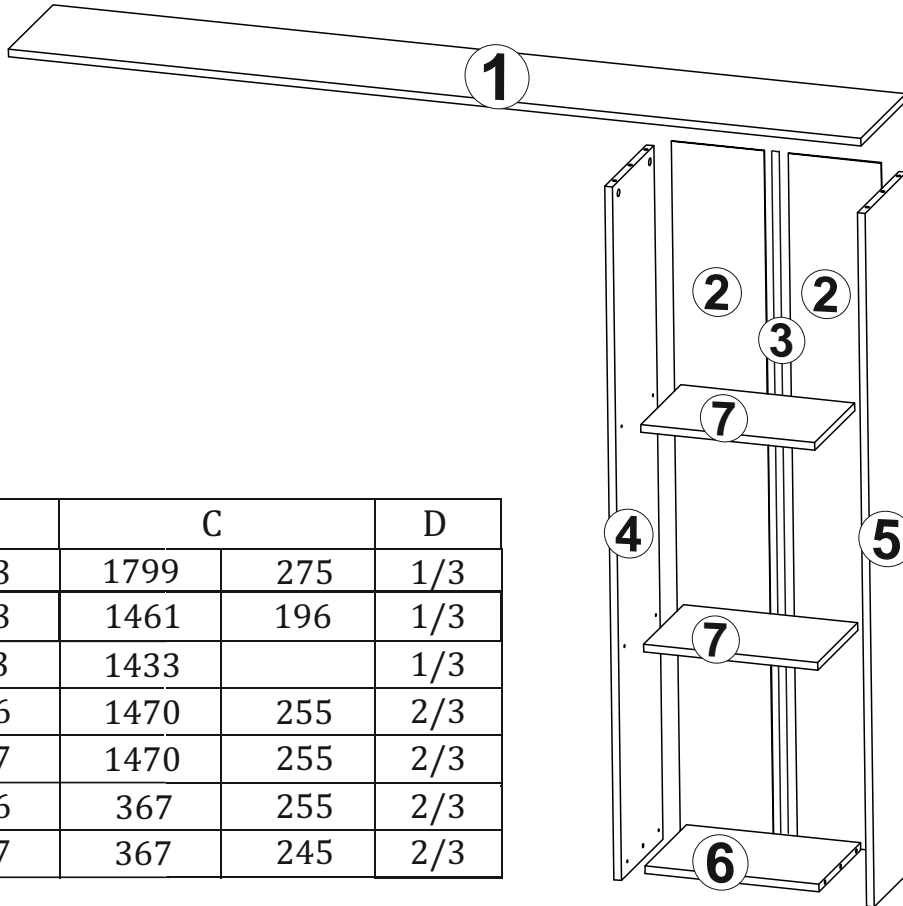

A	B	C		D
1	AD2-203	1799	275	1/3
2	AD2-903	1461	196	1/3
3	LH-1433	1433		1/3
4	AD2-106	1470	255	2/3
5	AD2-107	1470	255	2/3
6	AD2-306	367	255	2/3
7	AD2-307	367	245	2/3

**1**

