

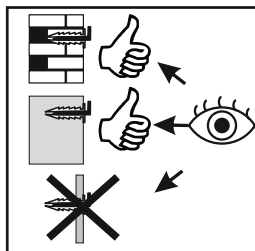

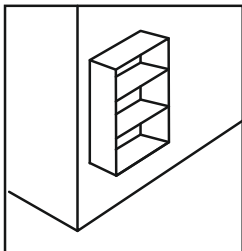

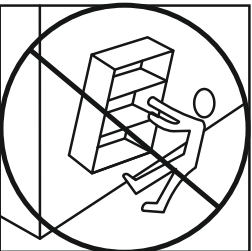

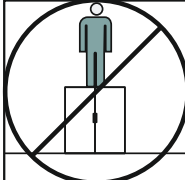

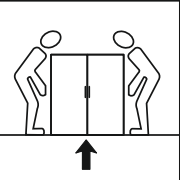
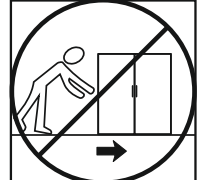
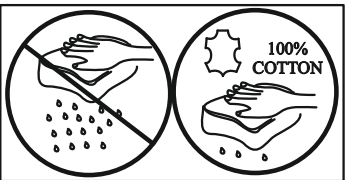
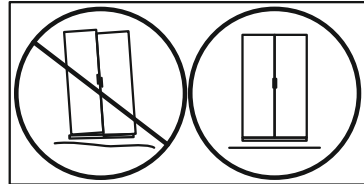
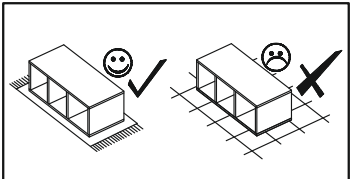
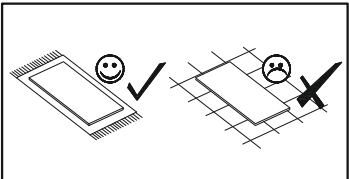
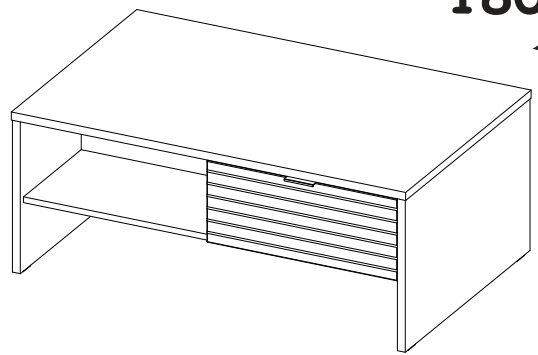

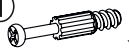

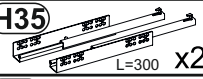

180°



<https://quefairedemesdechets.fr>

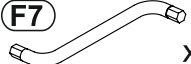

- B1**  ϕ 8x28 x28
- T1**  x20
- M1**  ϕ 15x12,5 x12
- M12**  ϕ 12x9,5 x8
- J23**  x8
- B4**  ϕ 6x40 x8
- H35**  L=300 x2
- H2**  x2
- E4**  6,3x13 x8
- S3**  3,5x13 x8
- C2**  ϕ 20 x8

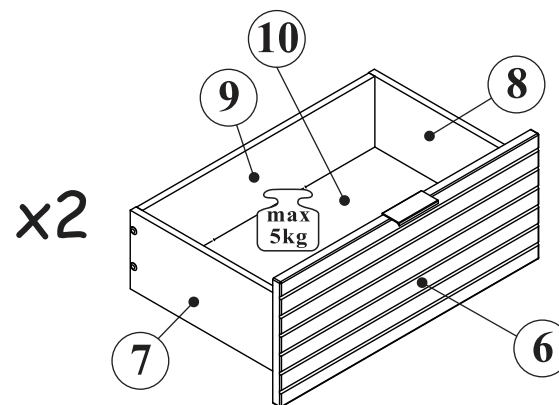
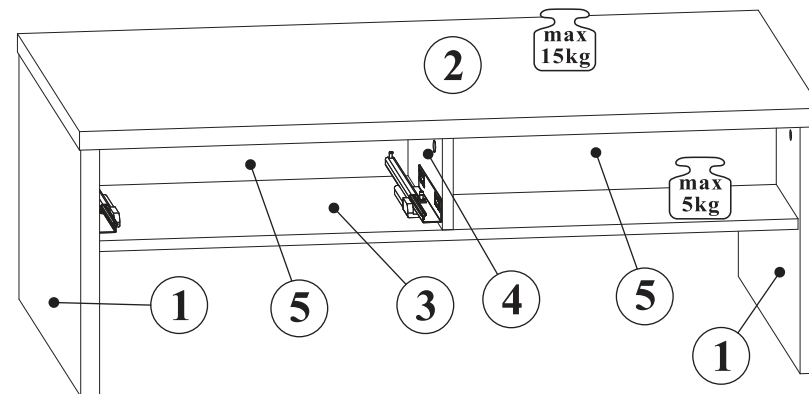

- F4**  x4
- G18**  x4
- F7**  x1
- F18**  x2
- S2**  3x13 x4

Nr				pcs	
1	416	696	22	2	1
2	1100	700	22	1	2
3	1052	660	16	1	2
4	213	660	16	1	1
5	213	518	16	2	1
6	532	223	16	2	1
7	300	140	12	2	1
8	300	140	12	2	1
9	478	140	12	2	1
10	488	298	2	2	1

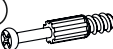

1

- B1**  ϕ 8x28 x4
- T1**  x4
- M1**  x4

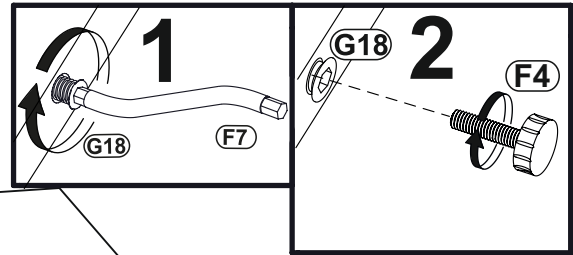
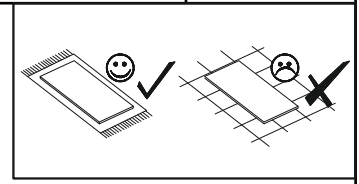

- F4**  x4
- G18**  x4
- F7**  x1

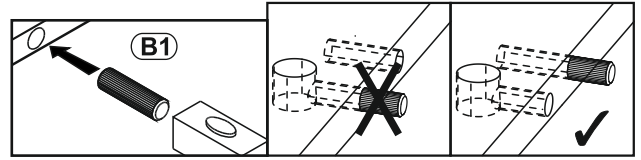
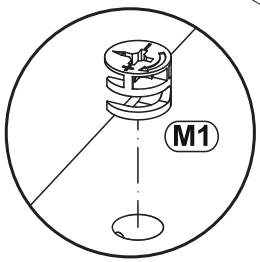
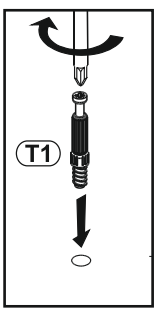
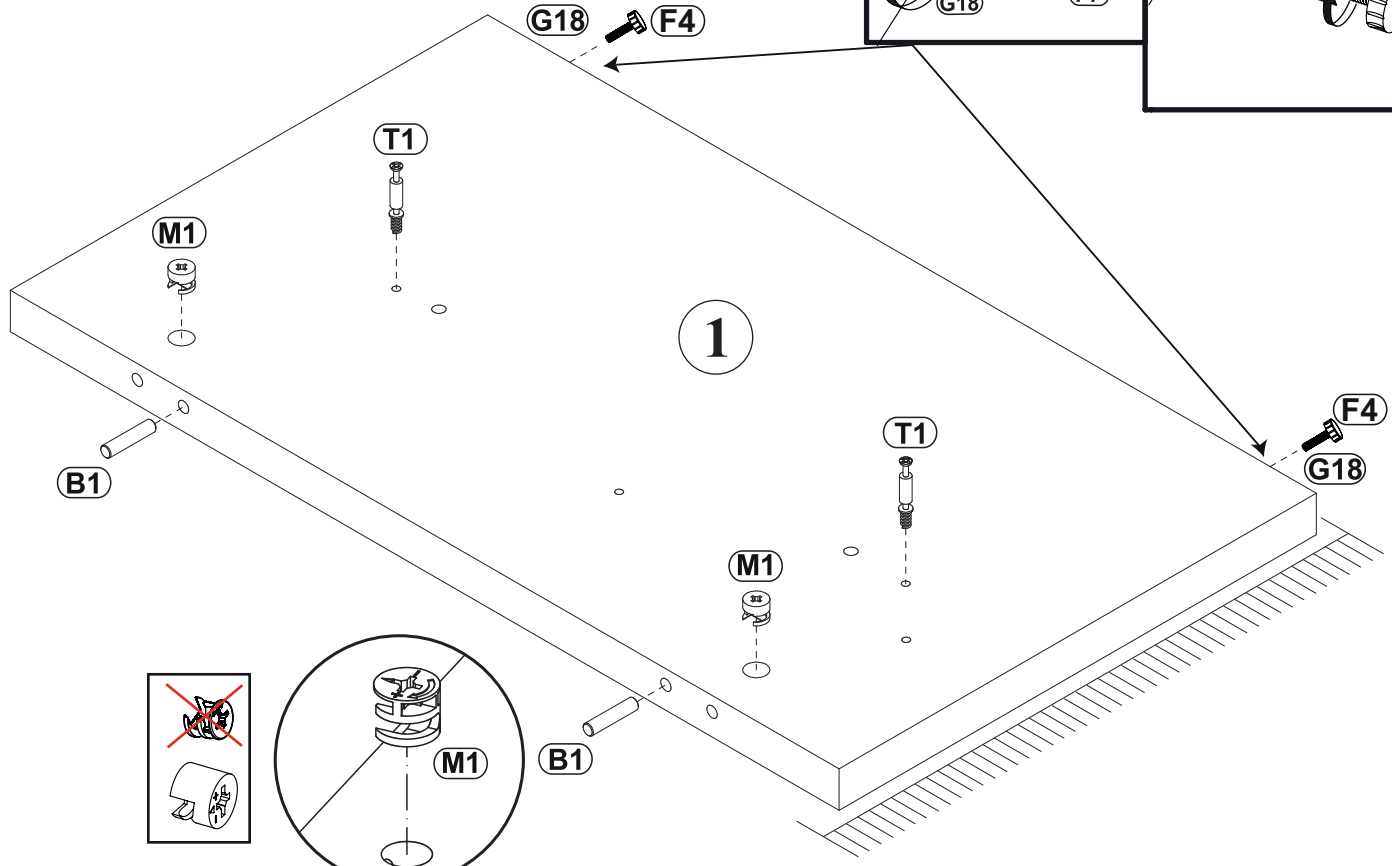

x2



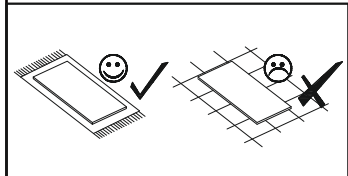
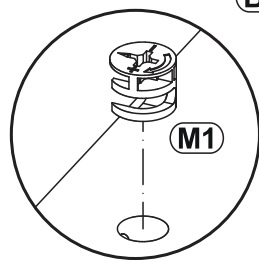
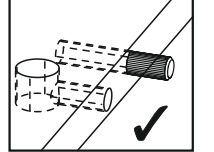
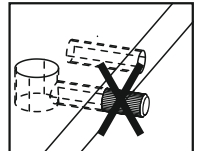
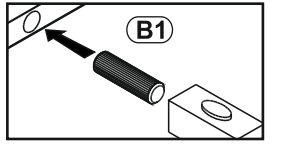
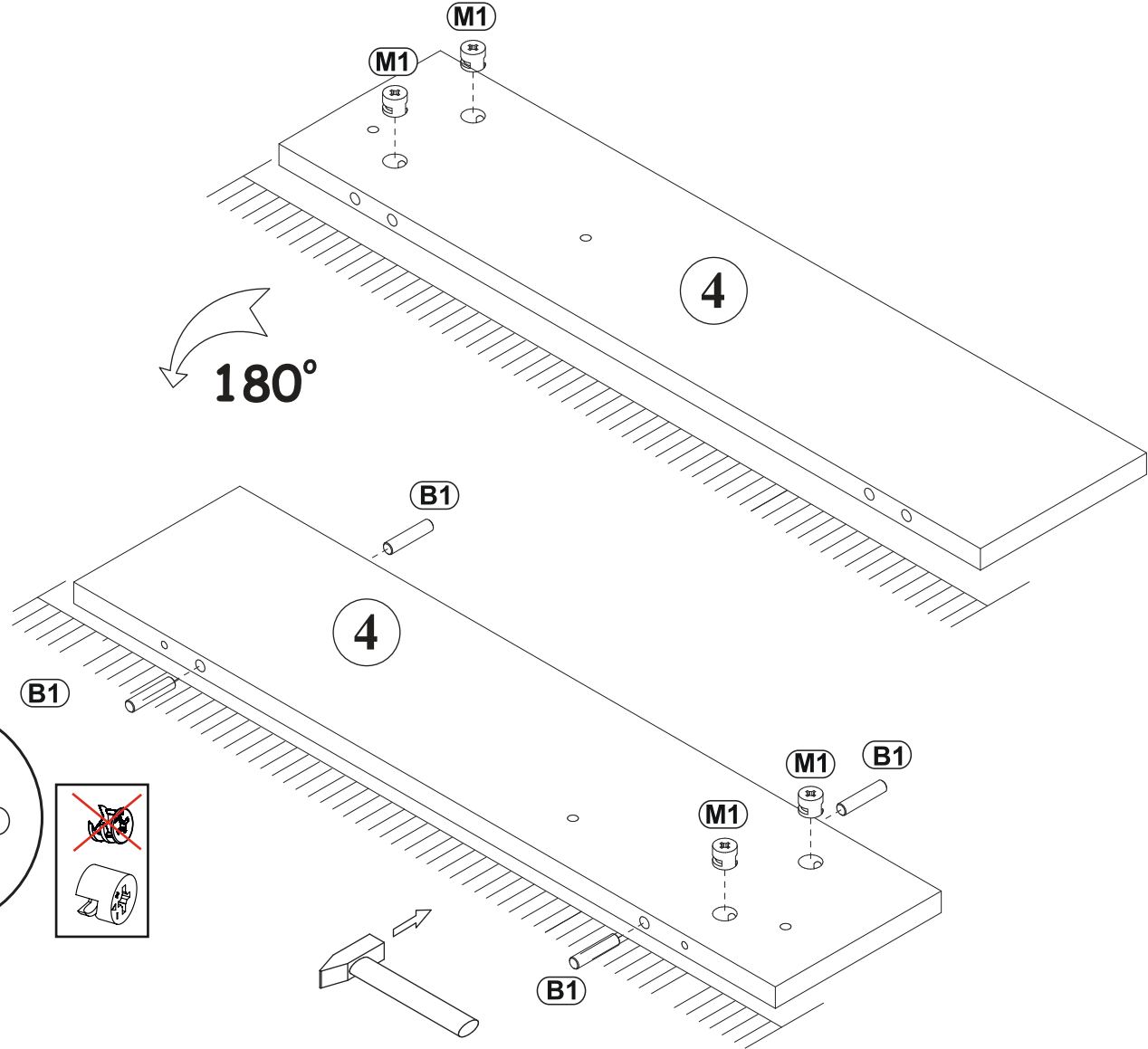

2

B1		ϕ 8x28	x4
M1			x4

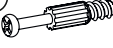

3

T1		x2
B1		x4 φ 8x28
M1		x4

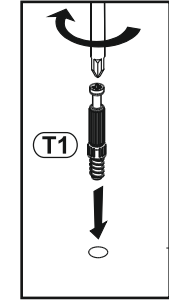
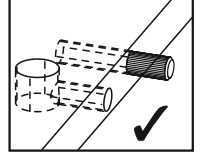
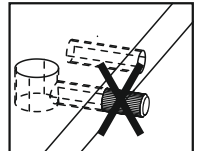
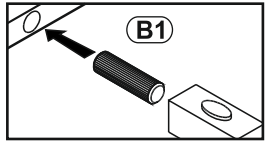

3B

180°

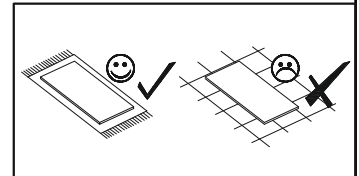
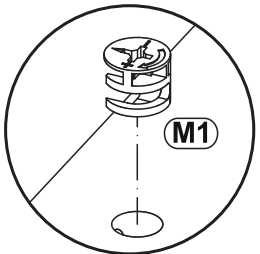
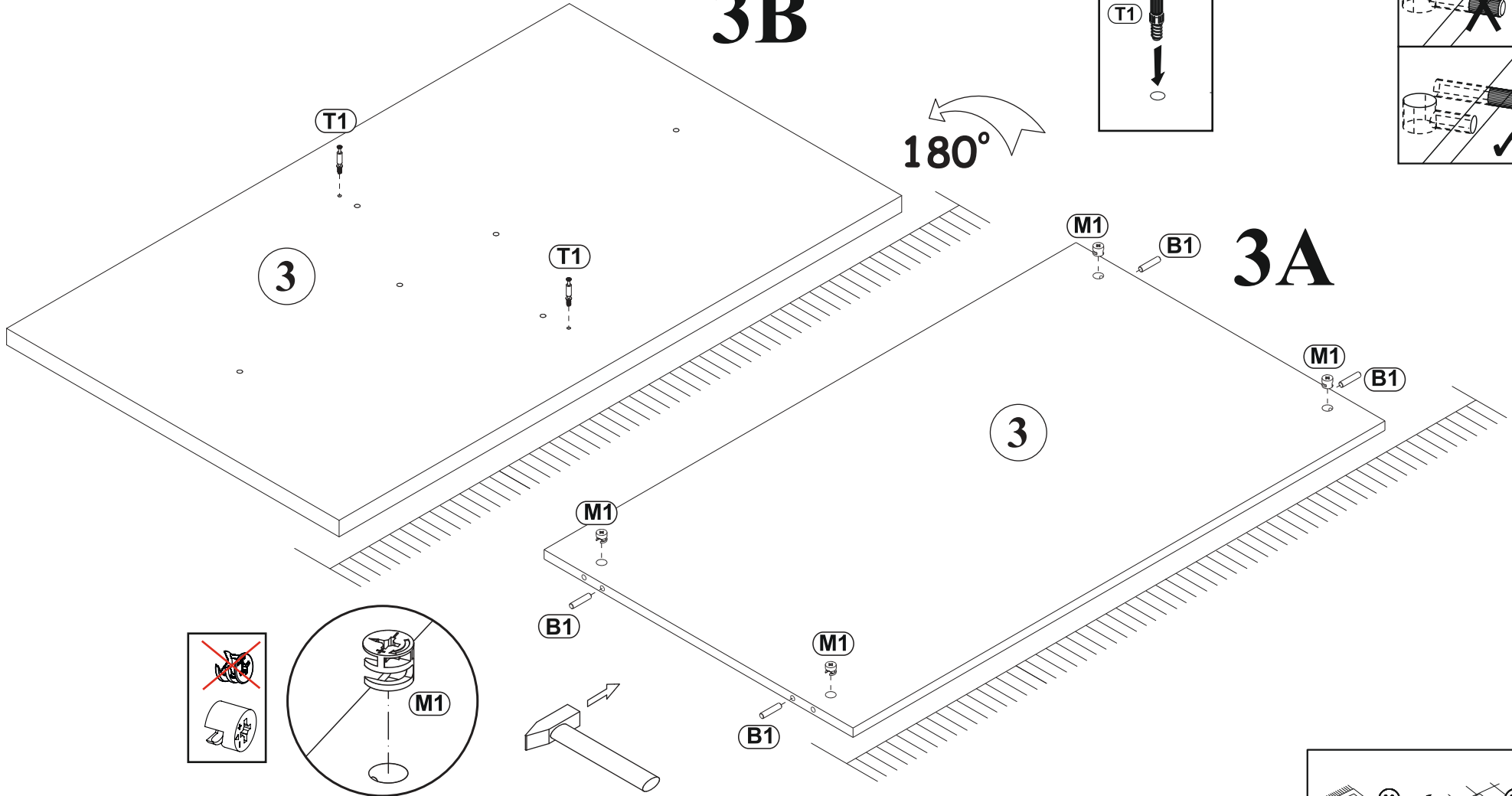

3A

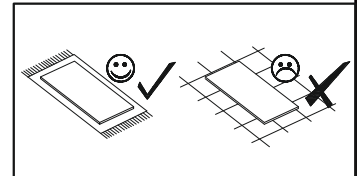
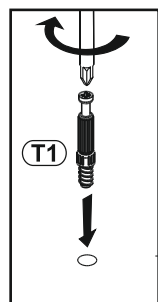
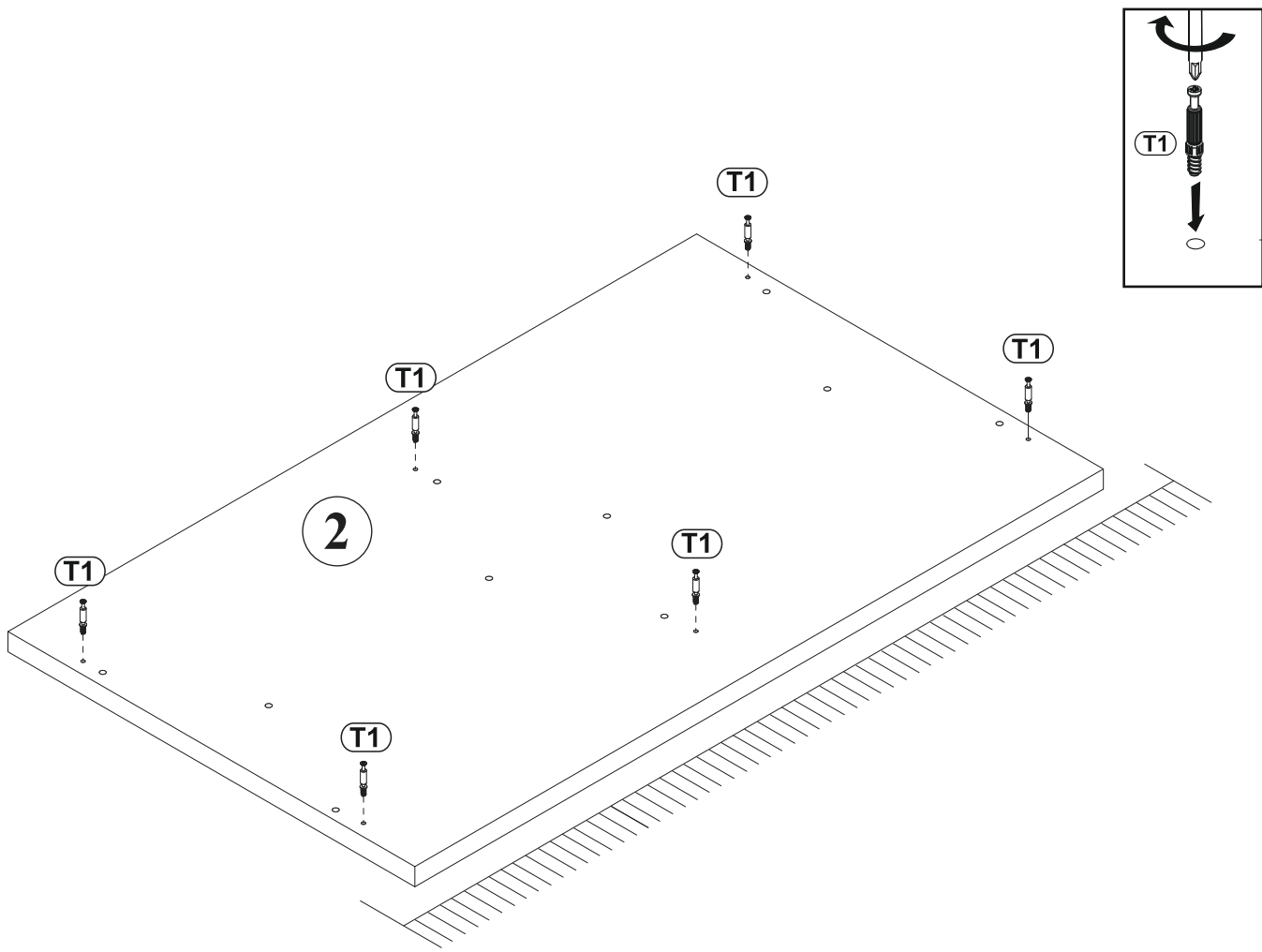
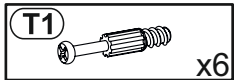

3

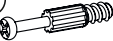

4

- B1**  ϕ 8x28 x16
- T1**  x8
- M12**  ϕ 12x9,5 x8

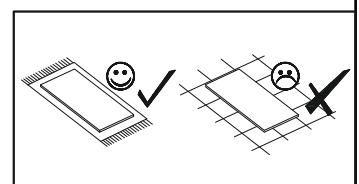
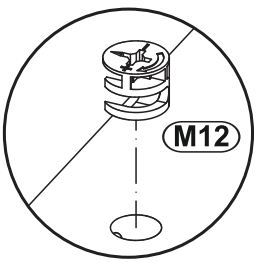
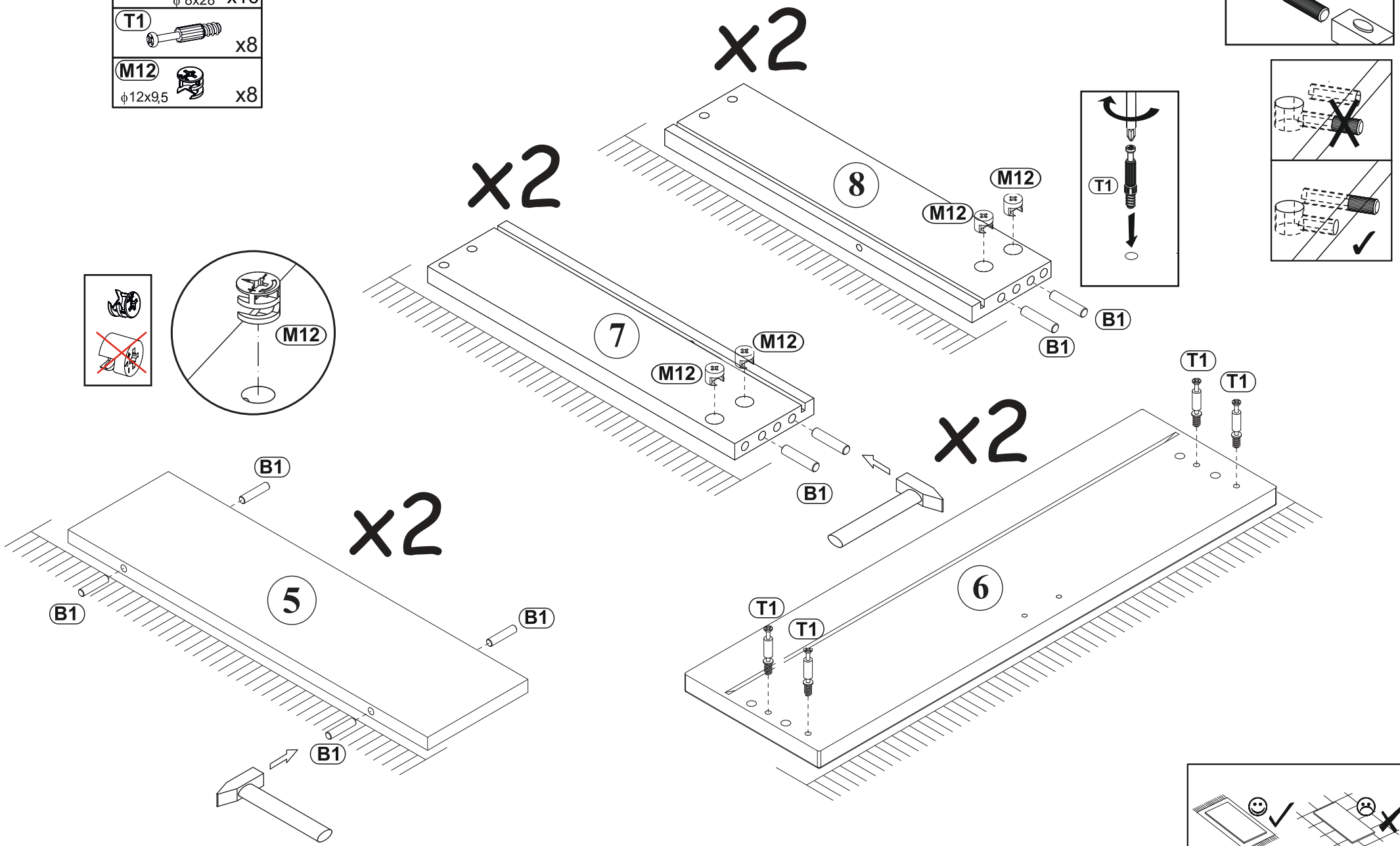
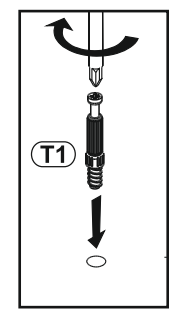
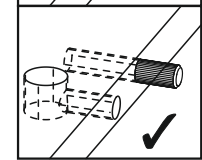
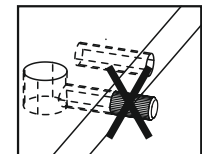
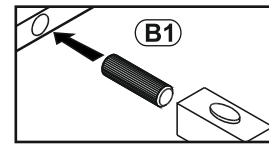

5

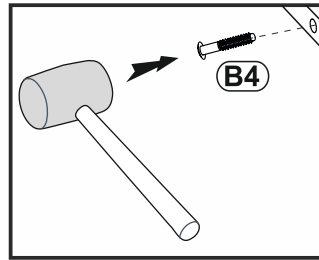
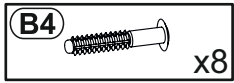

x2

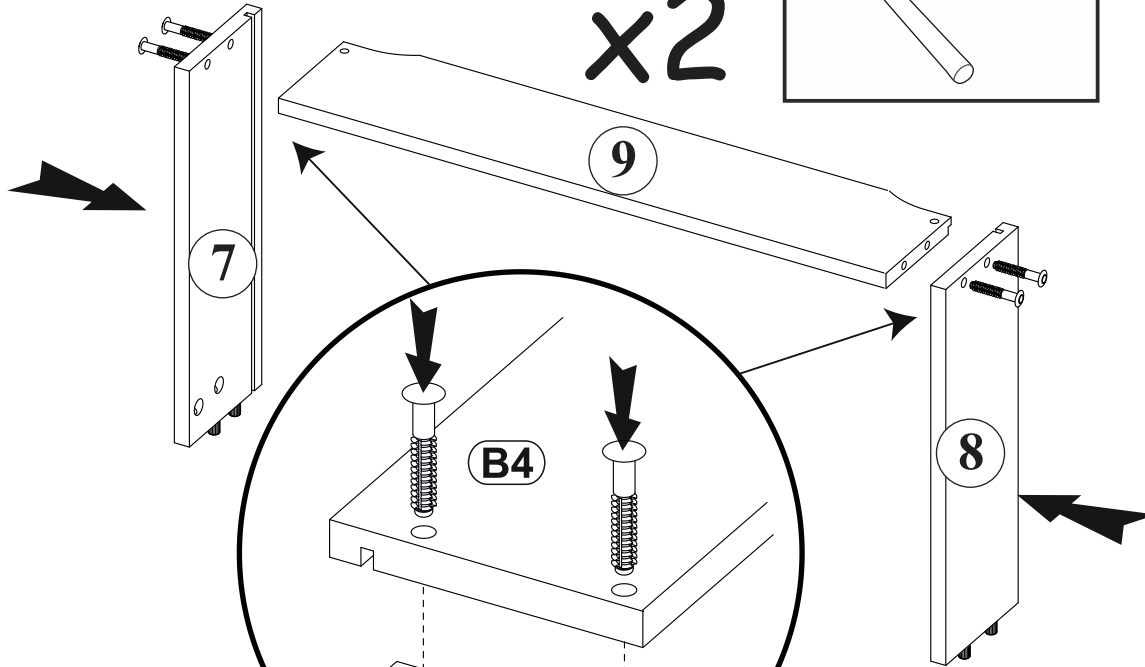
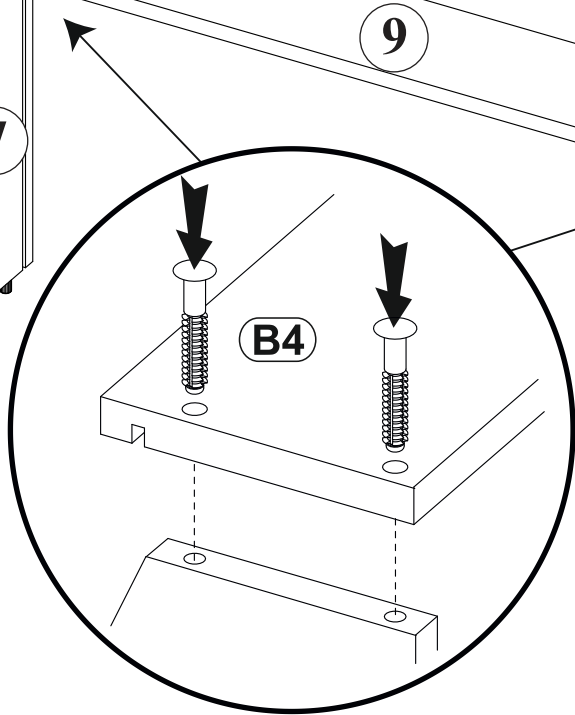

6

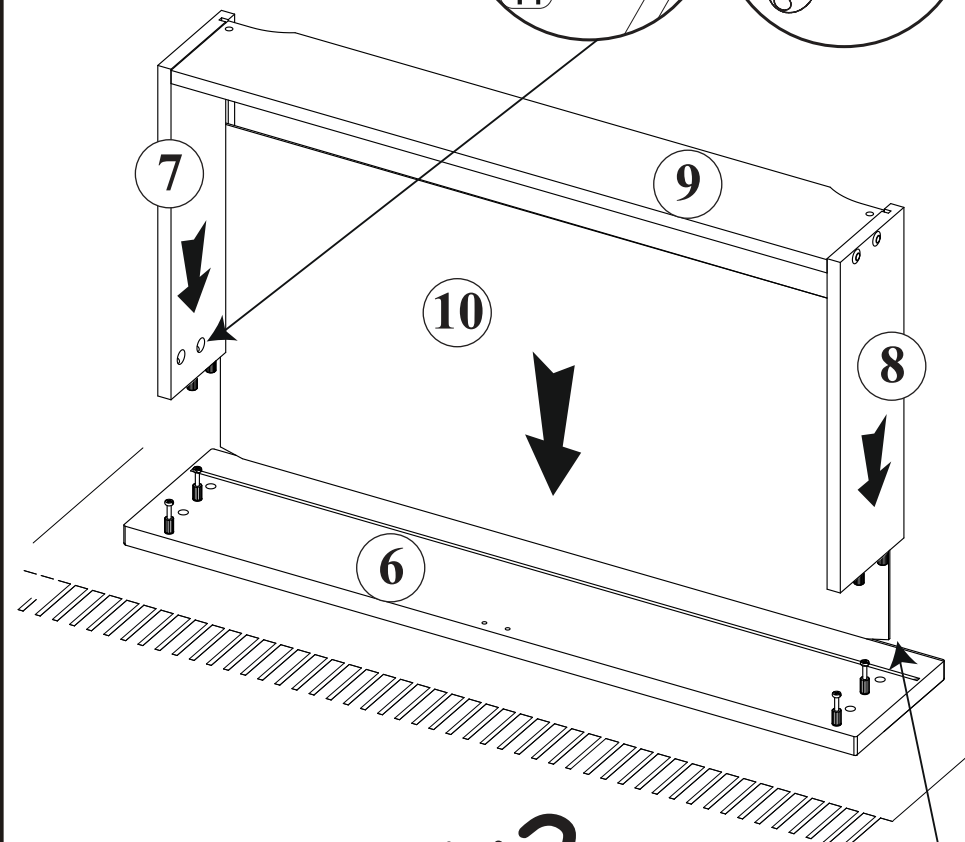
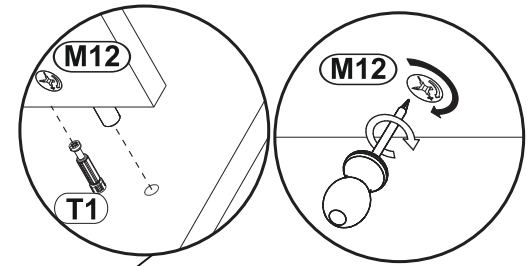

x2

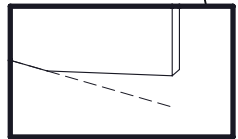
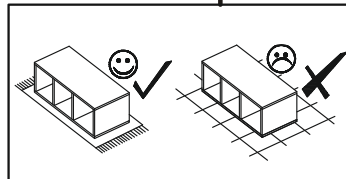

7

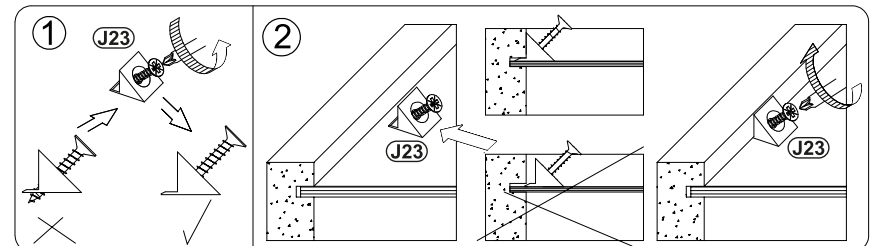
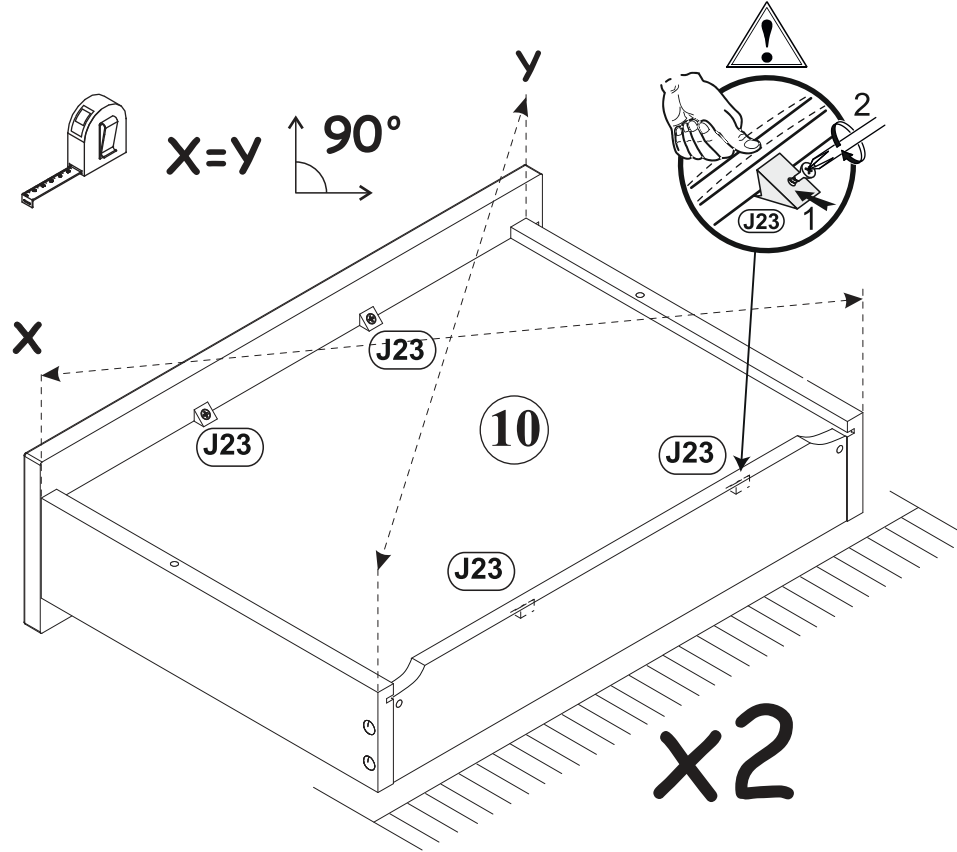
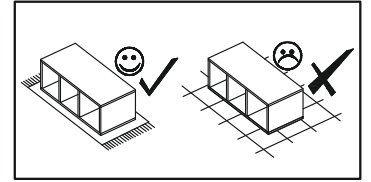
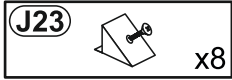

8

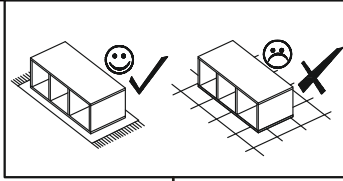
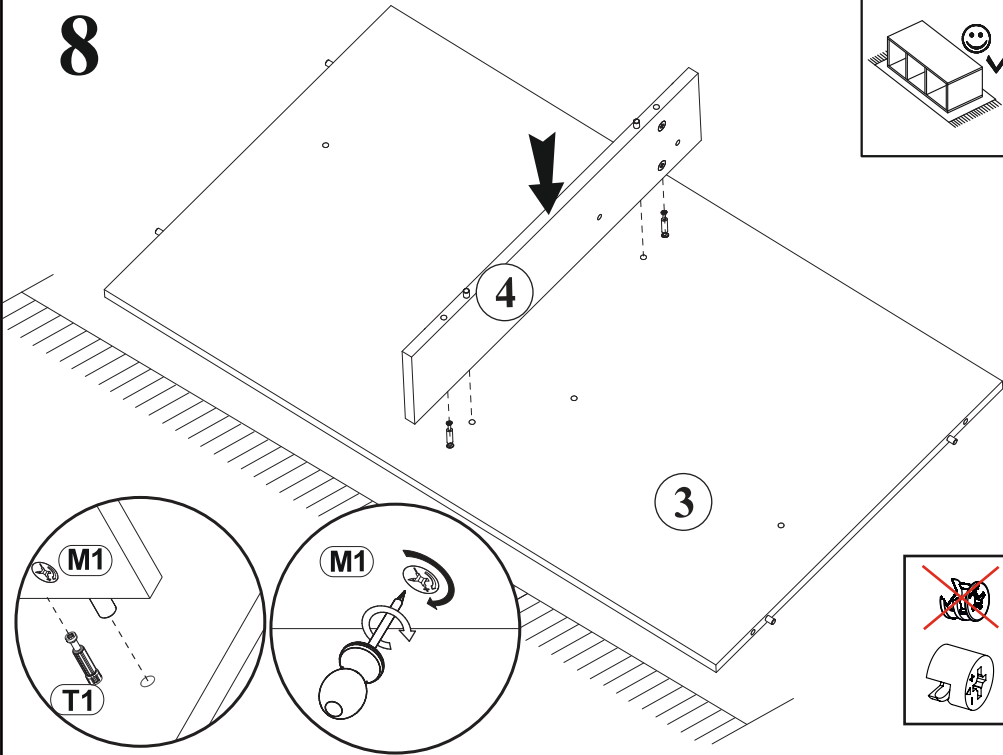

9



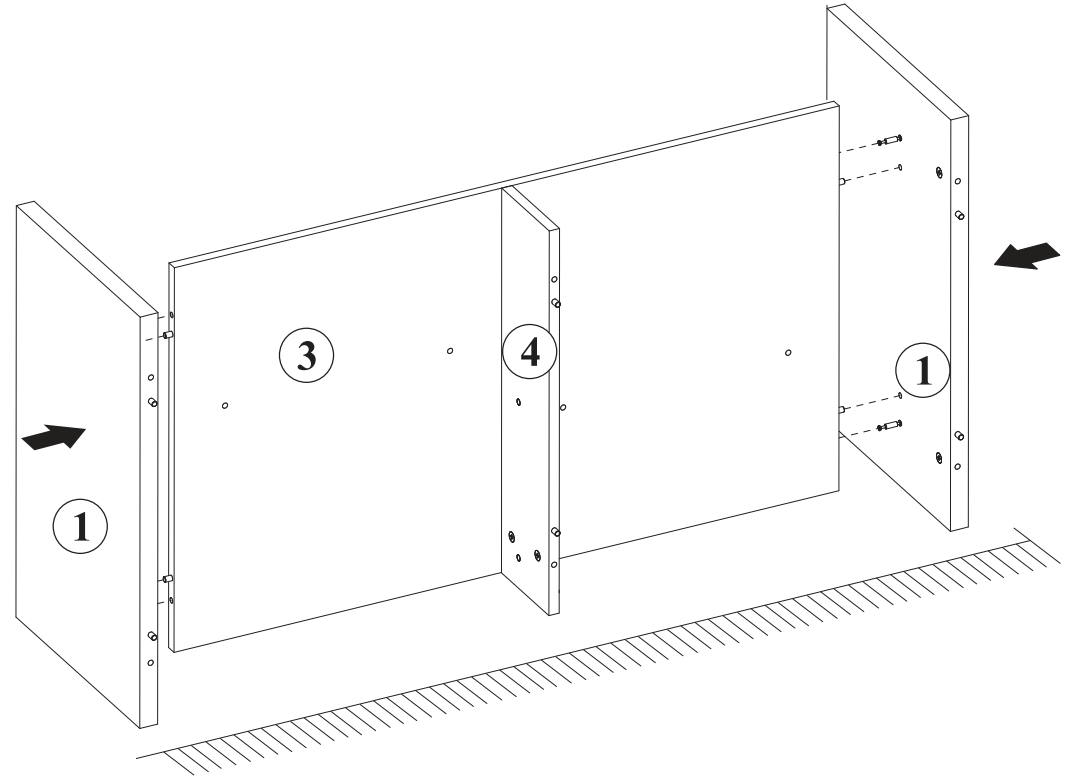

C2 ϕ 20 x4

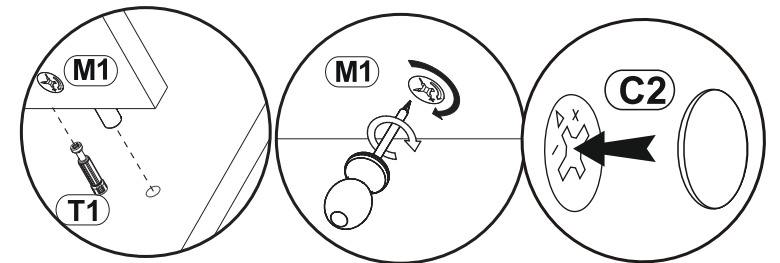
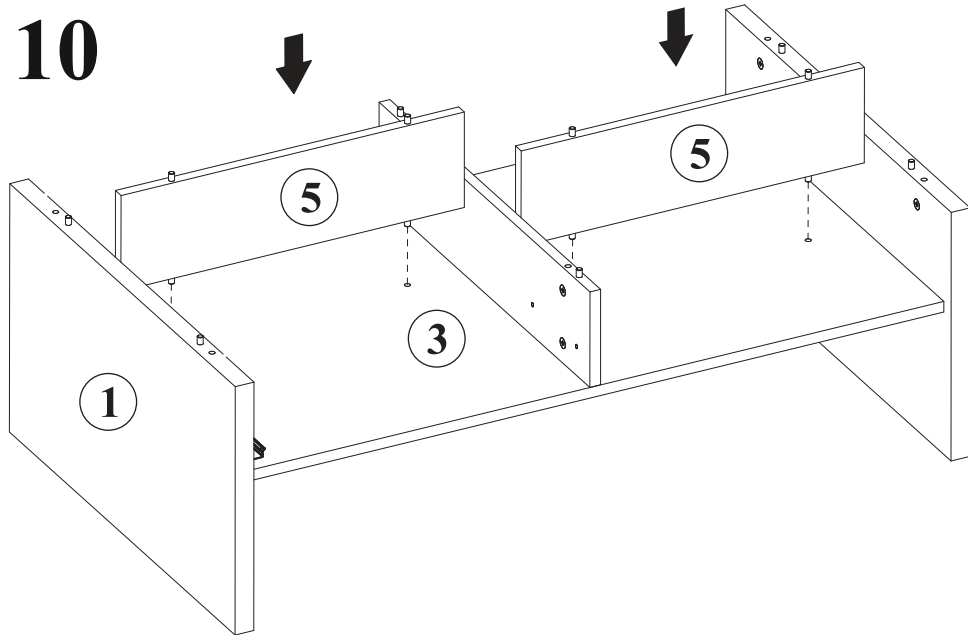

10

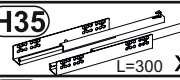

11

H35		L=300	x2
E4		6,3x13	x8
S3		3,5x13	x8
H2			x2

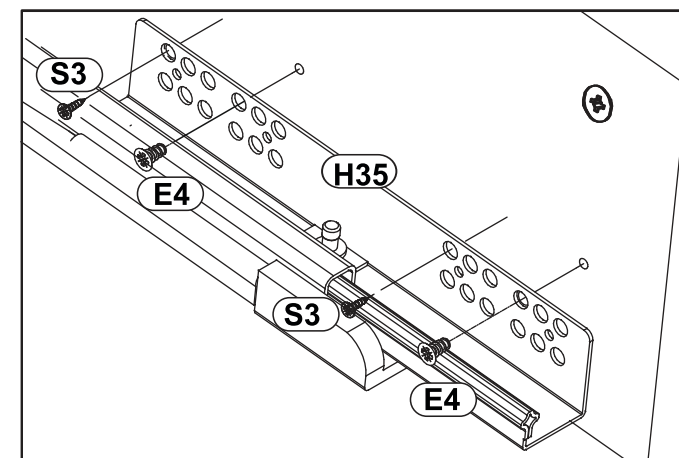
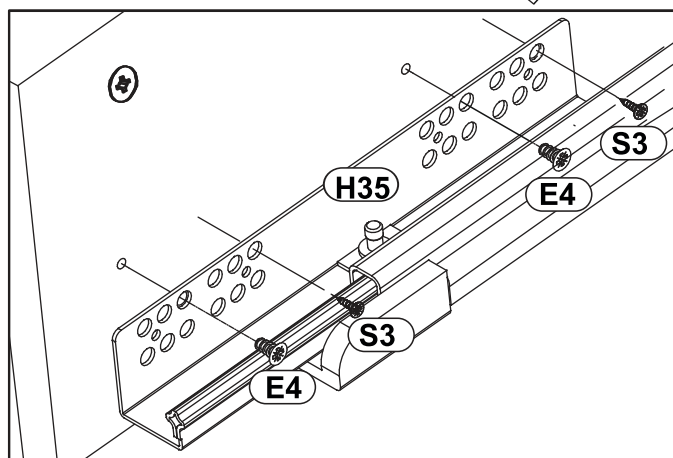
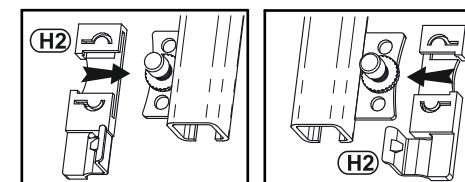
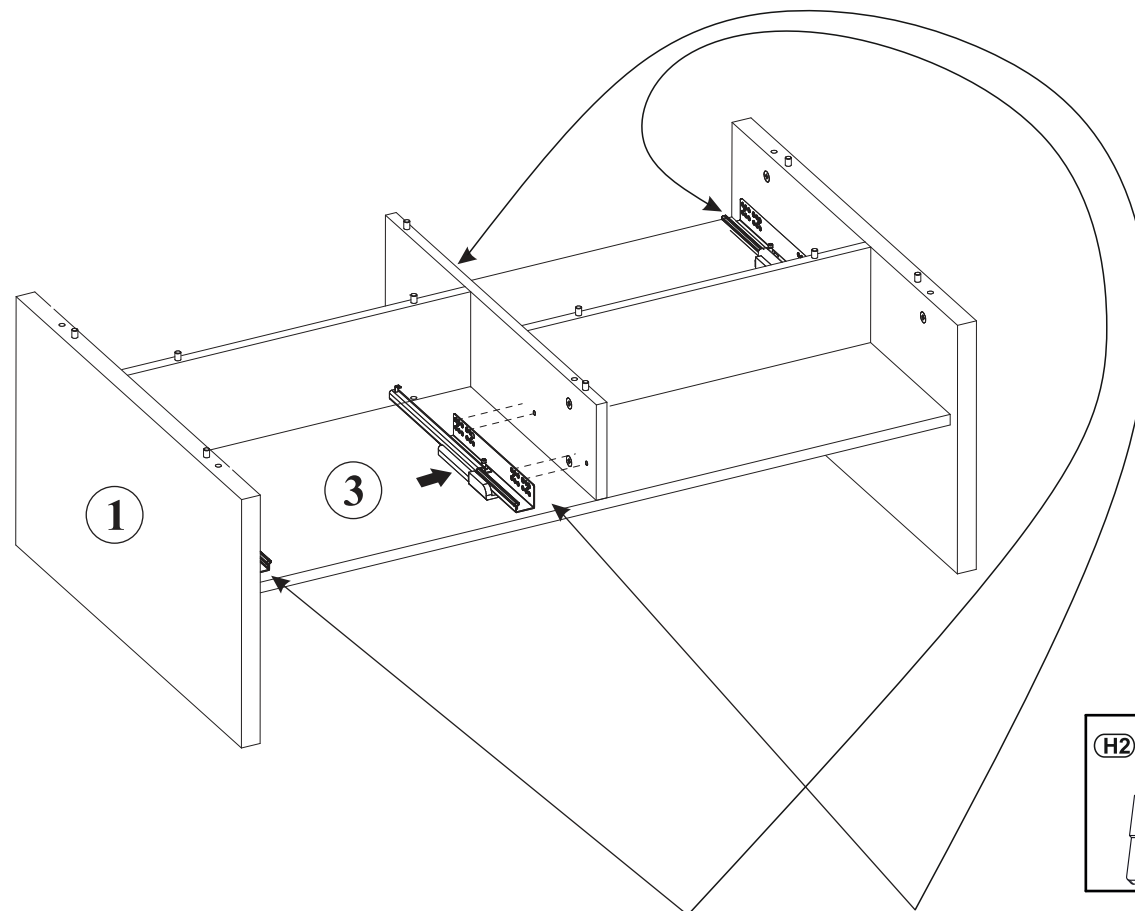

12

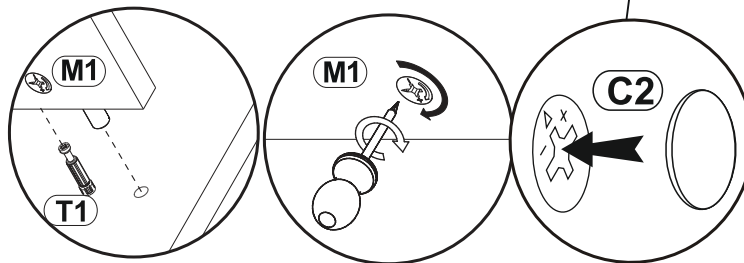
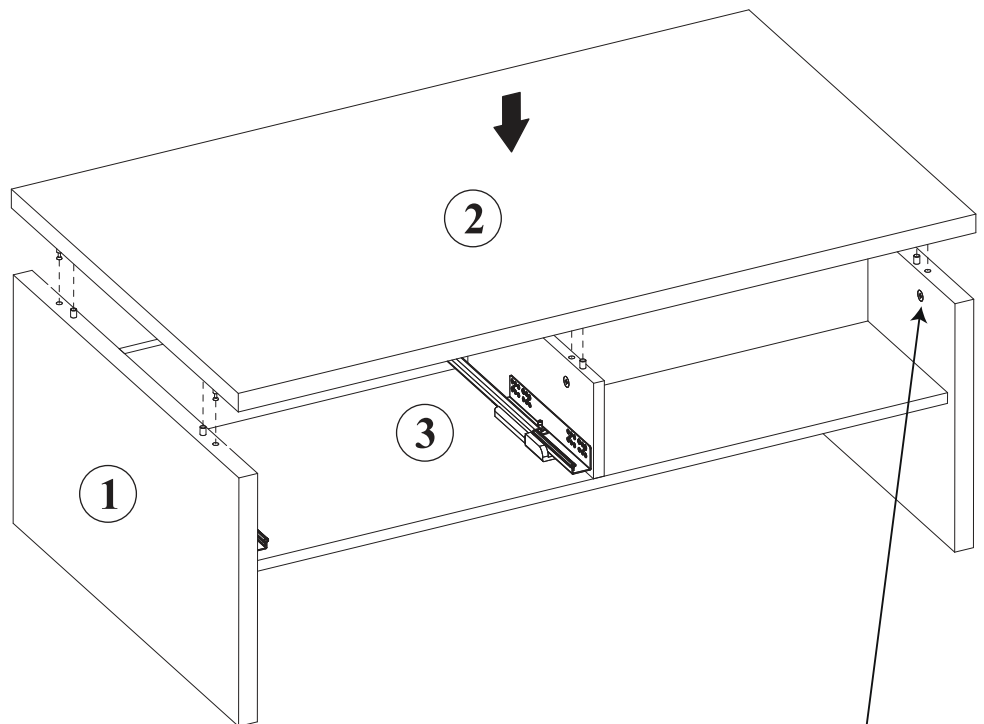
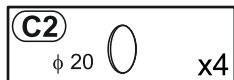

13

- (F18) x2
- (S2) 3x13 x4

