

# CELINA

# 10-S1.-.-01

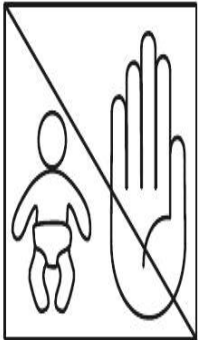

LEVÁ/LAVÁ    PRAVÁ

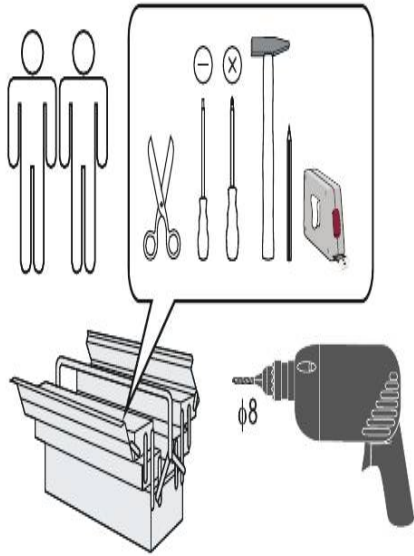
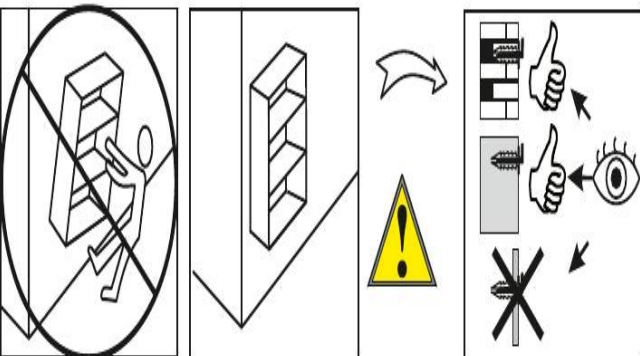
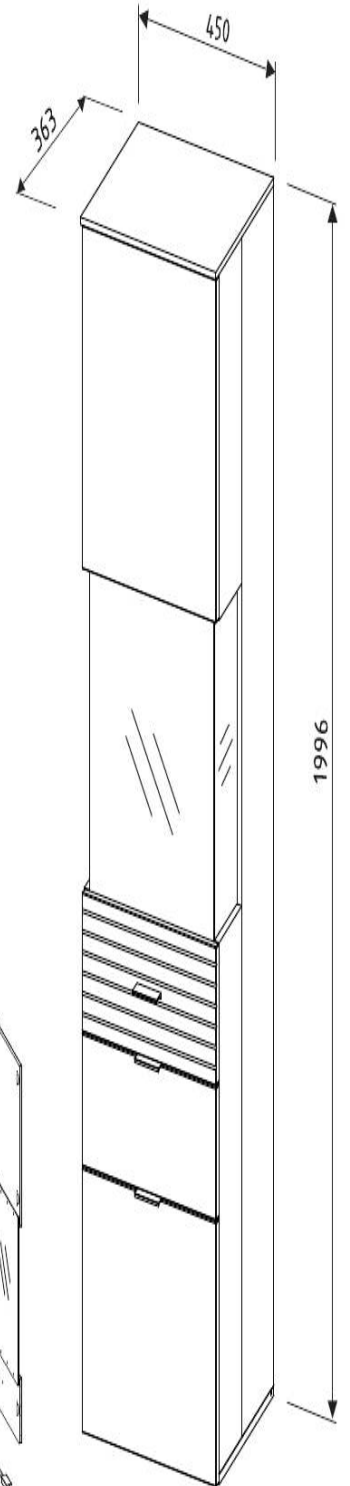
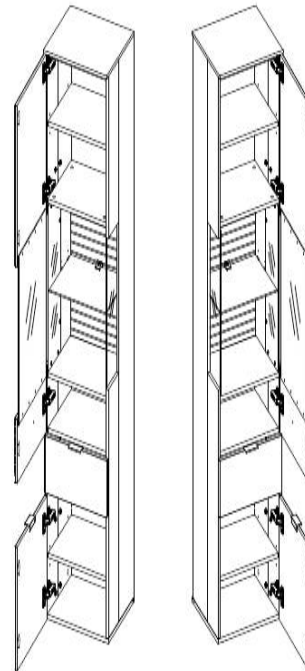
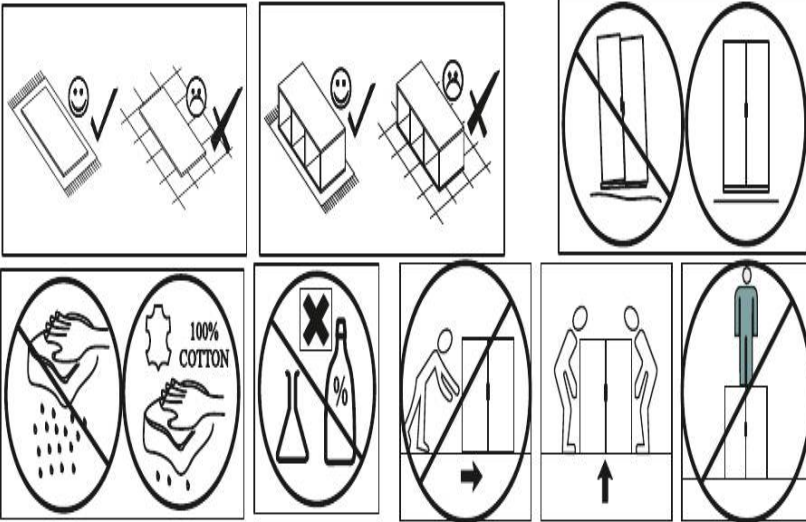

<https://quefairedemesdechets.fr>

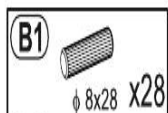

φ 8x28 x28

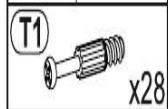

x28

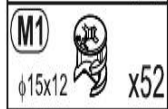

φ 15x12 x52

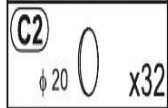

φ 20 x32

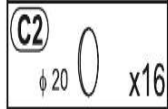

φ 20 x16



φ 12x9 x4

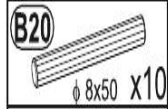

φ 8x50 x10

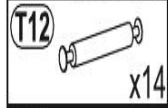

x14



x4

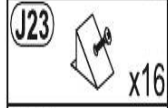

x16

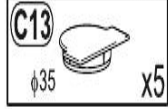

φ 35 x5

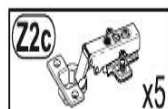

x5

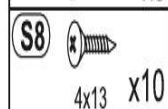

4x13 x10

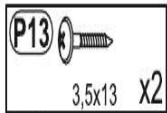

3,5x13 x2



x4



4x20 x4

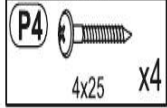

4x25 x4

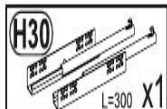

L=300 x1

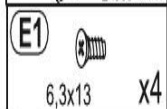

6,3x13 x4

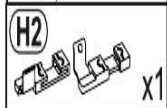

x1

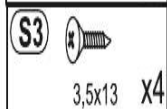

3,5x13 x4

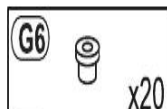

x20

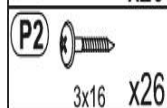

3x16 x26



x1

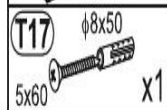

φ 8x50 x1

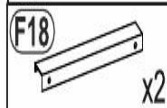

x2

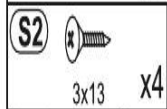

3x13 x4

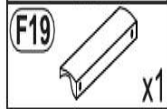

x1



M4x22 x2



x1



x1



x4

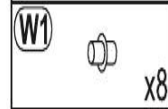

x8

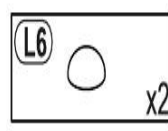

x2

Nr	↙	↕	↗	pcs	☐
1	1953	205	16	1	2
2	561	134	16	1	2
3	864	134	16	1	2
4	1953	205	16	1	2
5	561	134	16	1	2
6	864	134	16	1	2
7	416	318	16	1	1
8	450	340	16	1	1
9	416	314	16	2	2
10	416	314	16	1	2
11	416	309	16	2	1
12	404	285	6	1	1
13	578	159	4	2	1
14	587	414	4	1	1
15	558	446	16	1	1
16	446	225	16	1	2
17	431	446	16	1	1
18	300	140	12	1	2
19	300	140	12	1	2
20	376	140	12	1	2
21	446	215	16	1	2
22	386	298	2	1	1
23	450	363	12	1	1
24	416	588	16	1	1
25	430	528	2	1	1
26	430	844	2	1	1

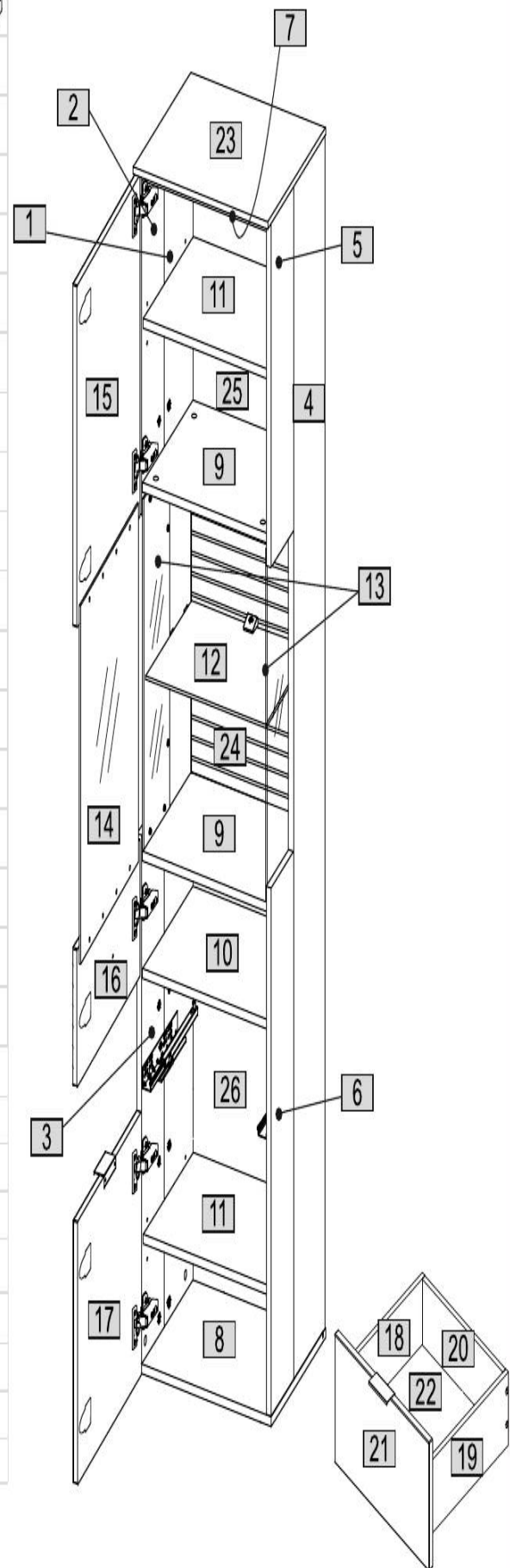

0 10 20 30 40 50 60 70 80 90 100 110 120 130 140 150 160 170 180 190 200

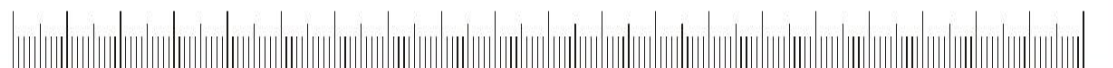

1

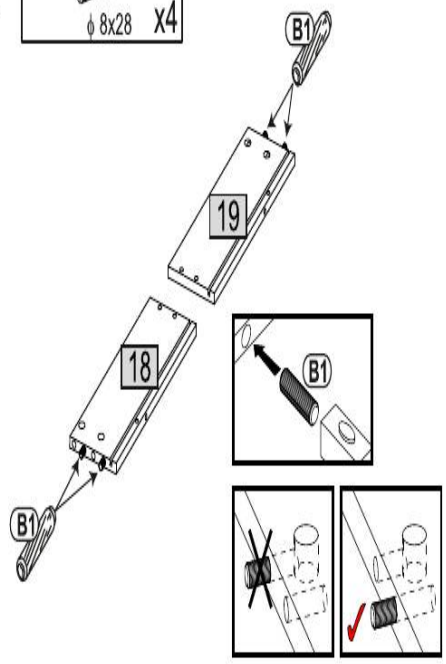
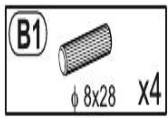

2

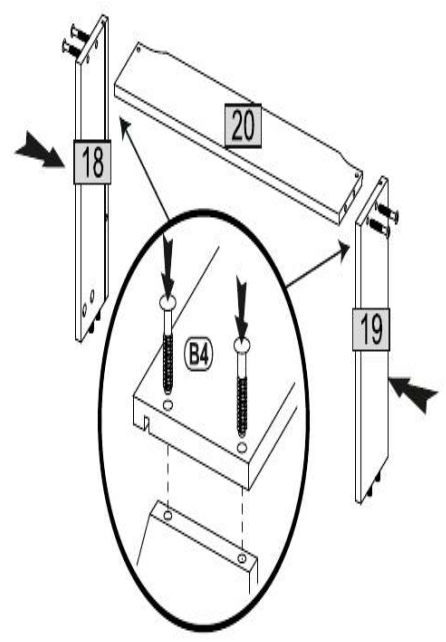
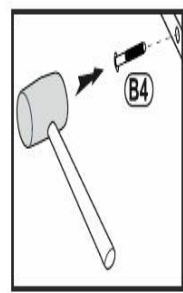

3

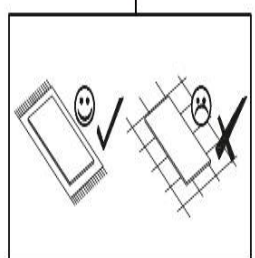
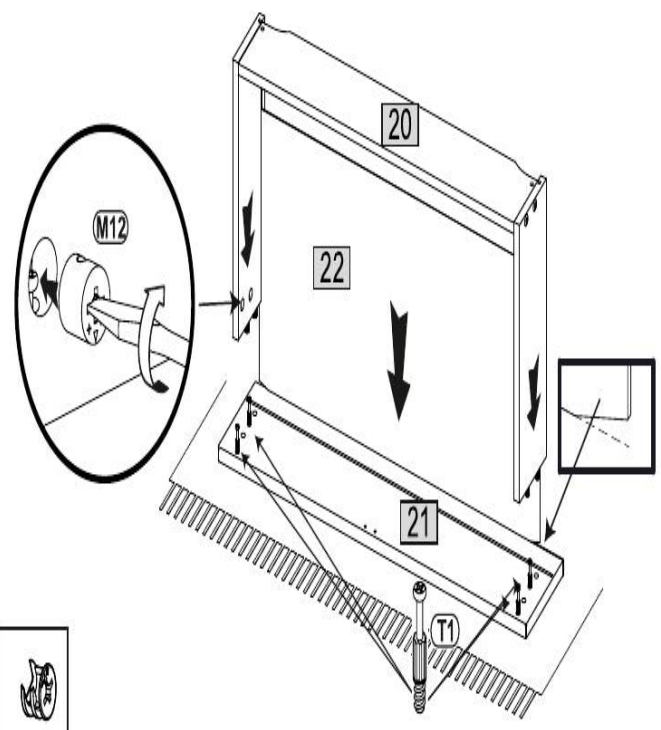
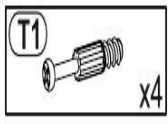

4

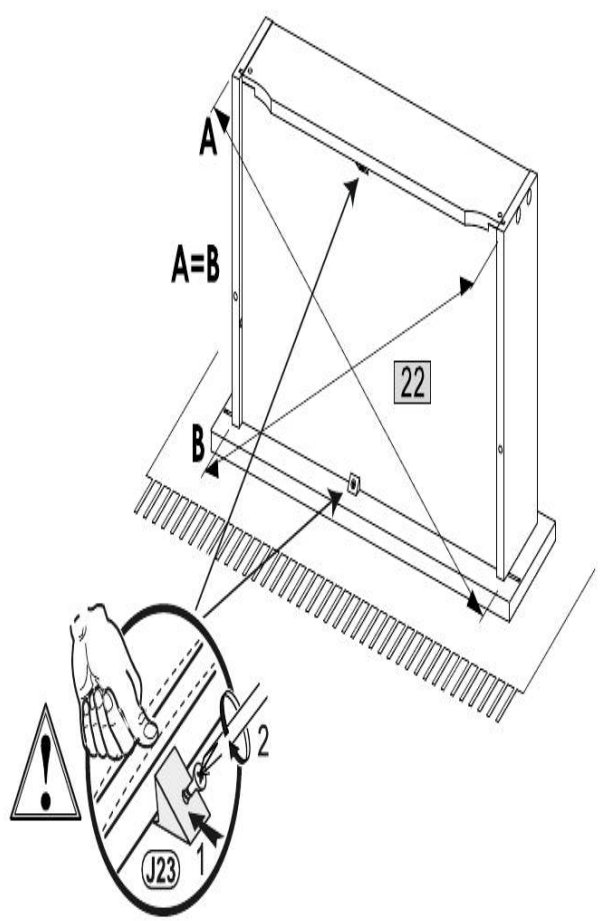
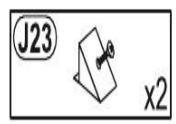

5

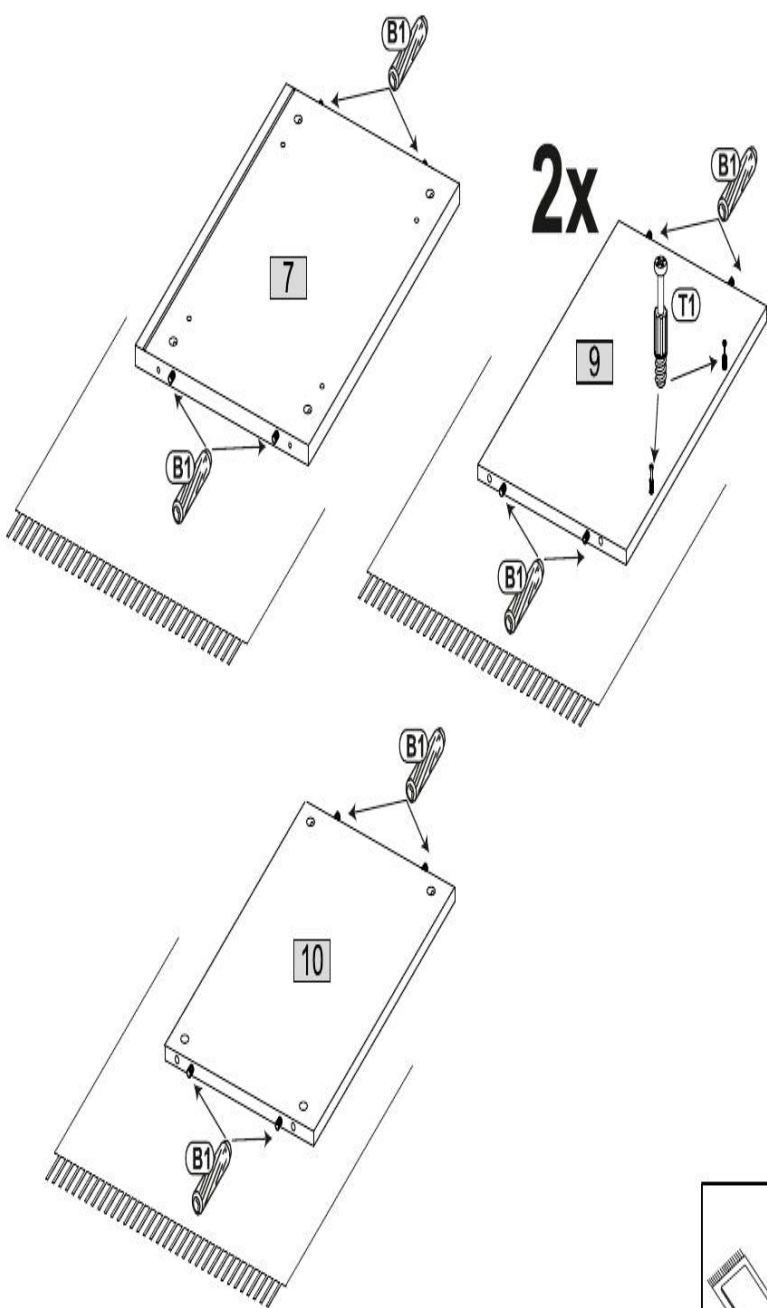
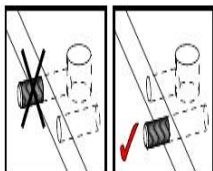
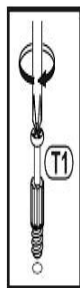
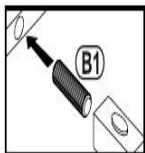
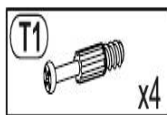
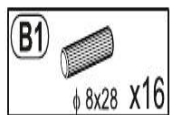

7

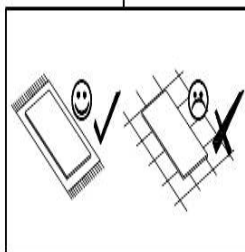
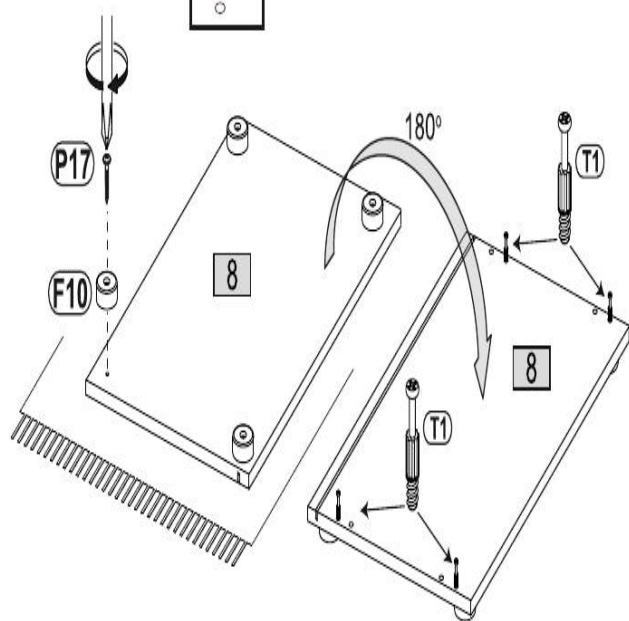
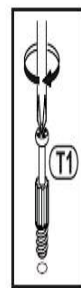
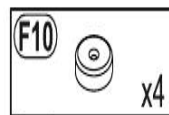
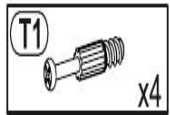

6

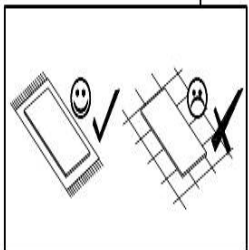
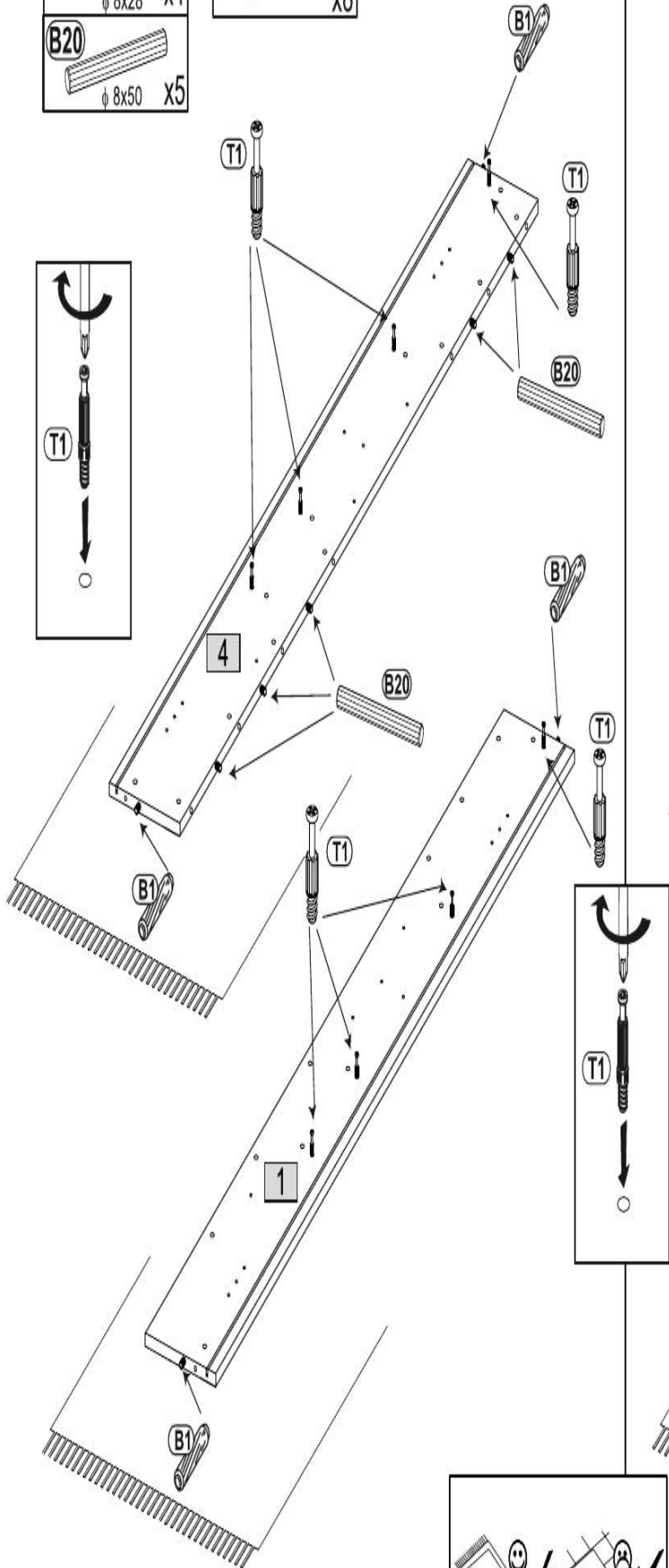
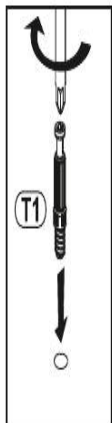
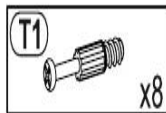
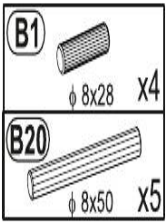

8

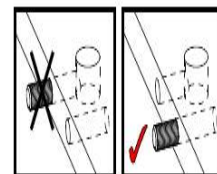
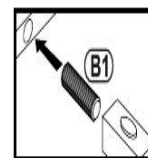
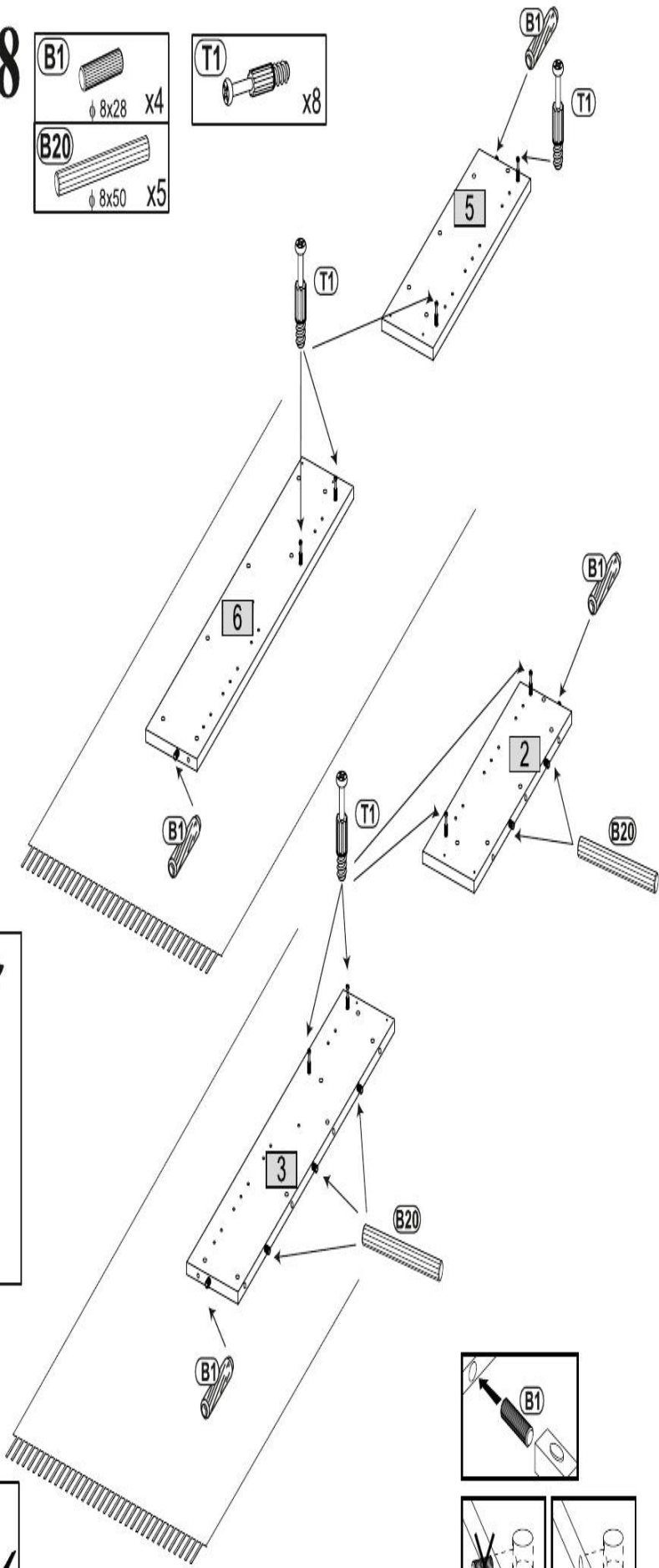
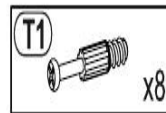
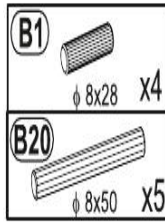

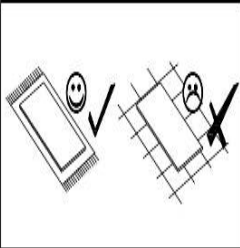
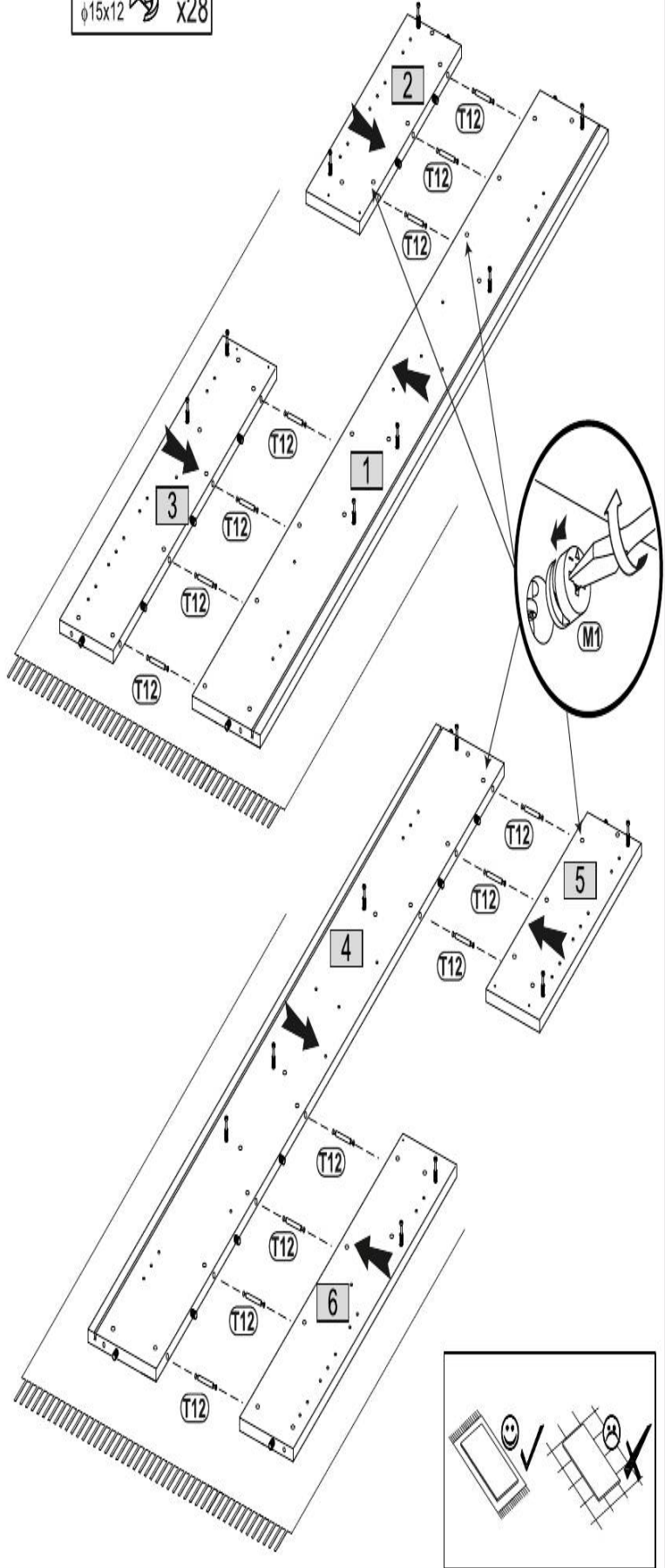
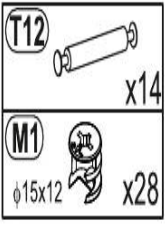

9

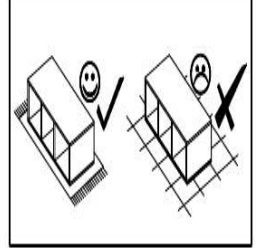
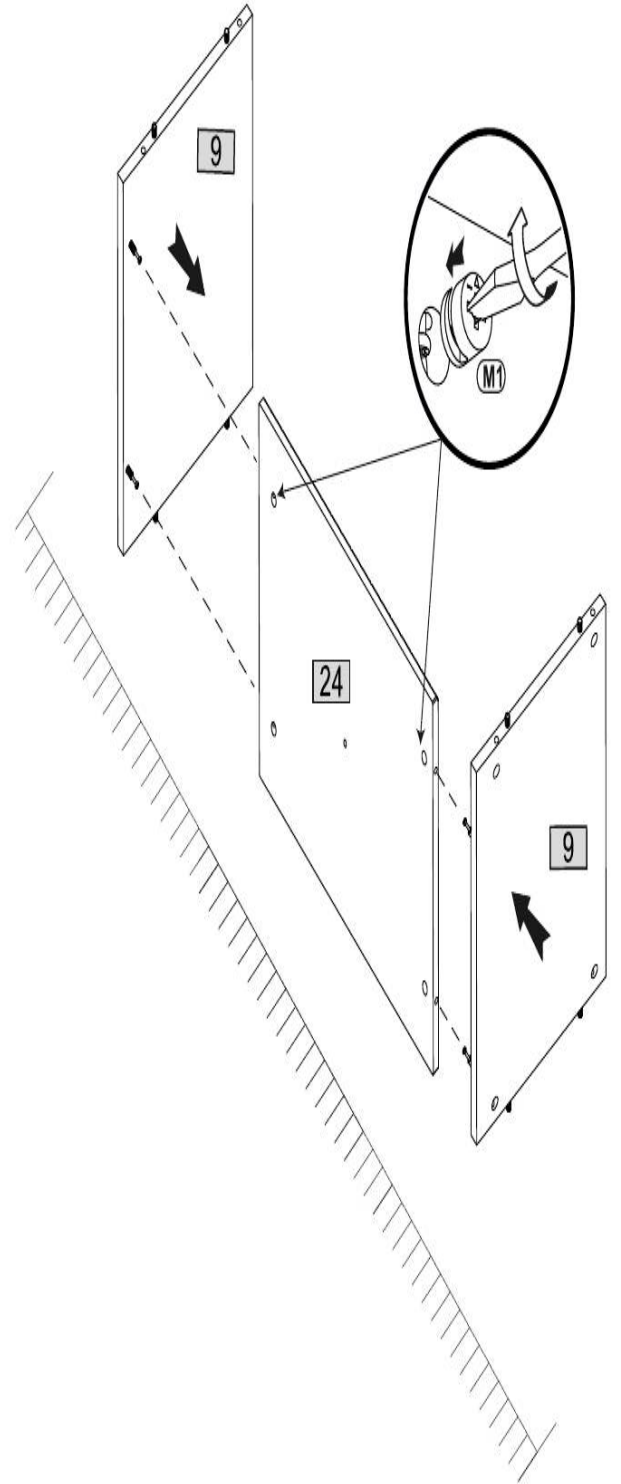

10





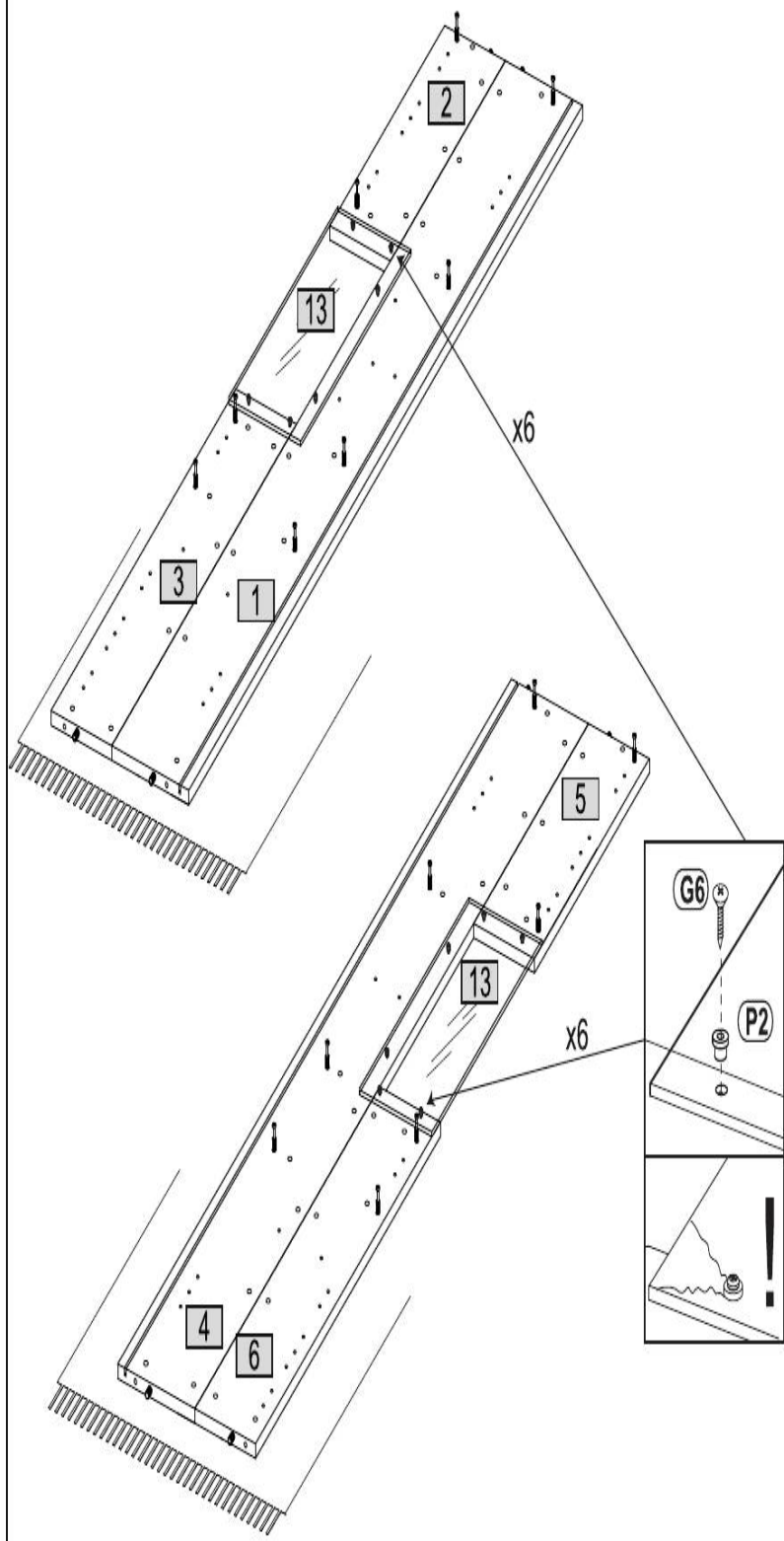
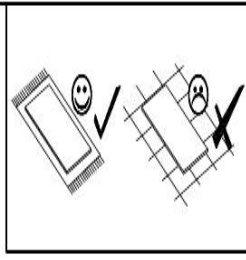

# 11

- G6**  x12
- P2**  3x16 x12



# 12

- Z2c**  x3
- S8**  4x13 x6
- G6**  x8
- P2**  3x16 x8
- C13**   $\phi 35$  x3

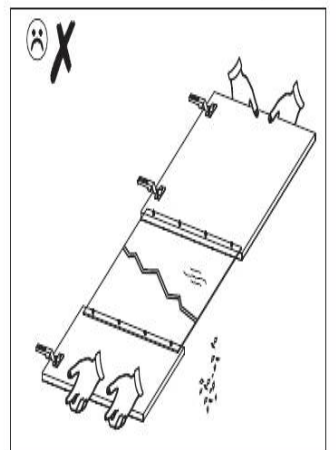
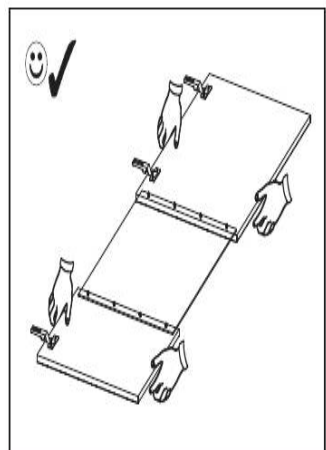
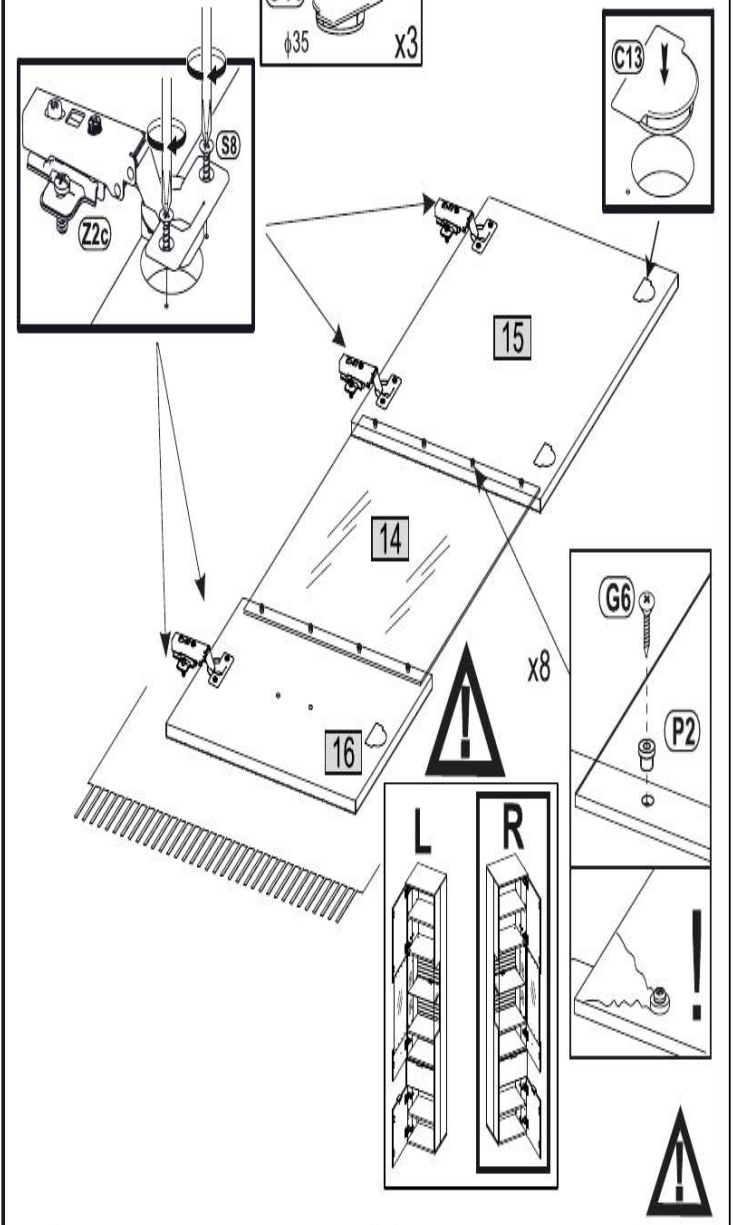
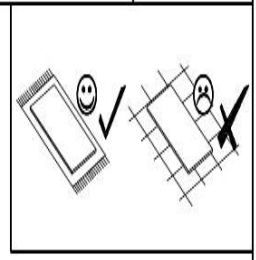

# 13

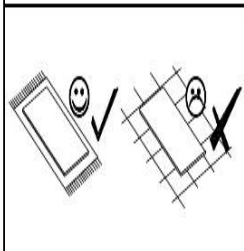
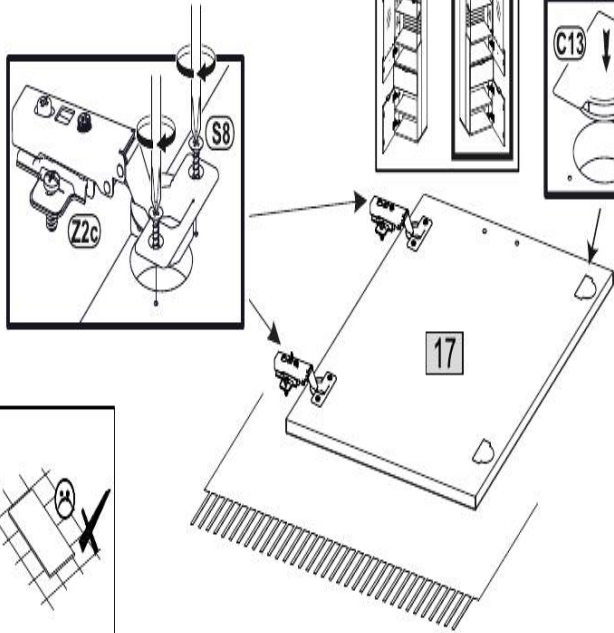
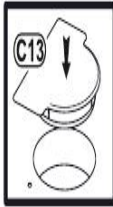
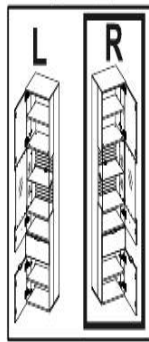
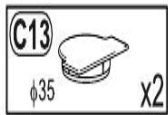
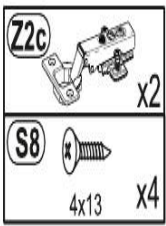

# 14

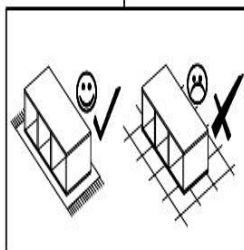
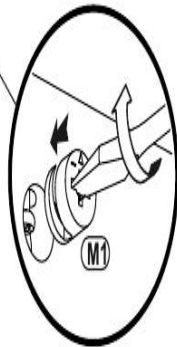
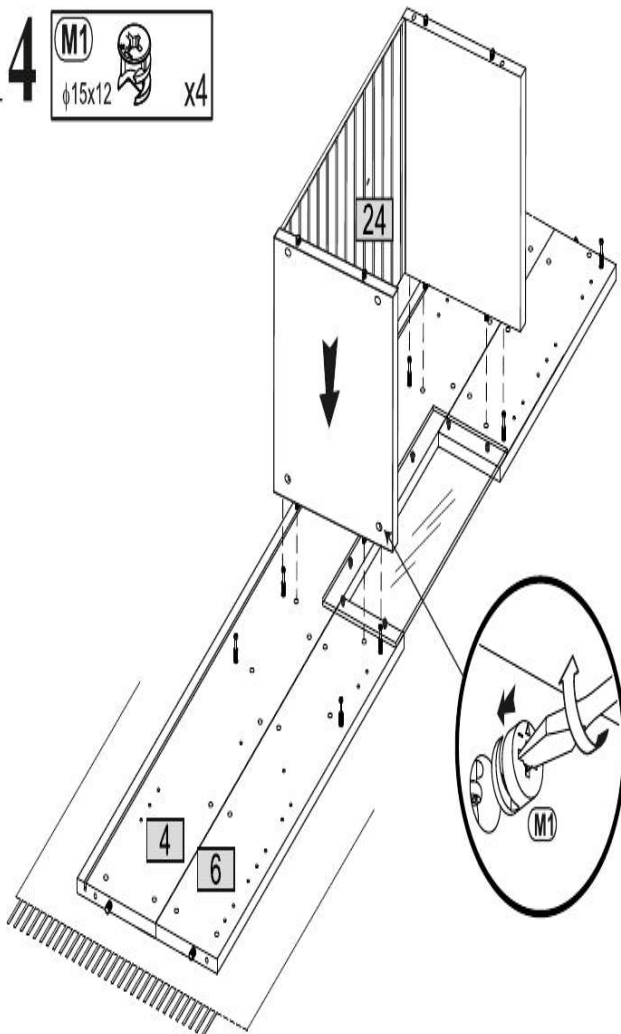

# 15

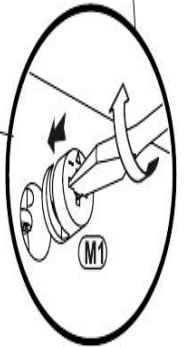
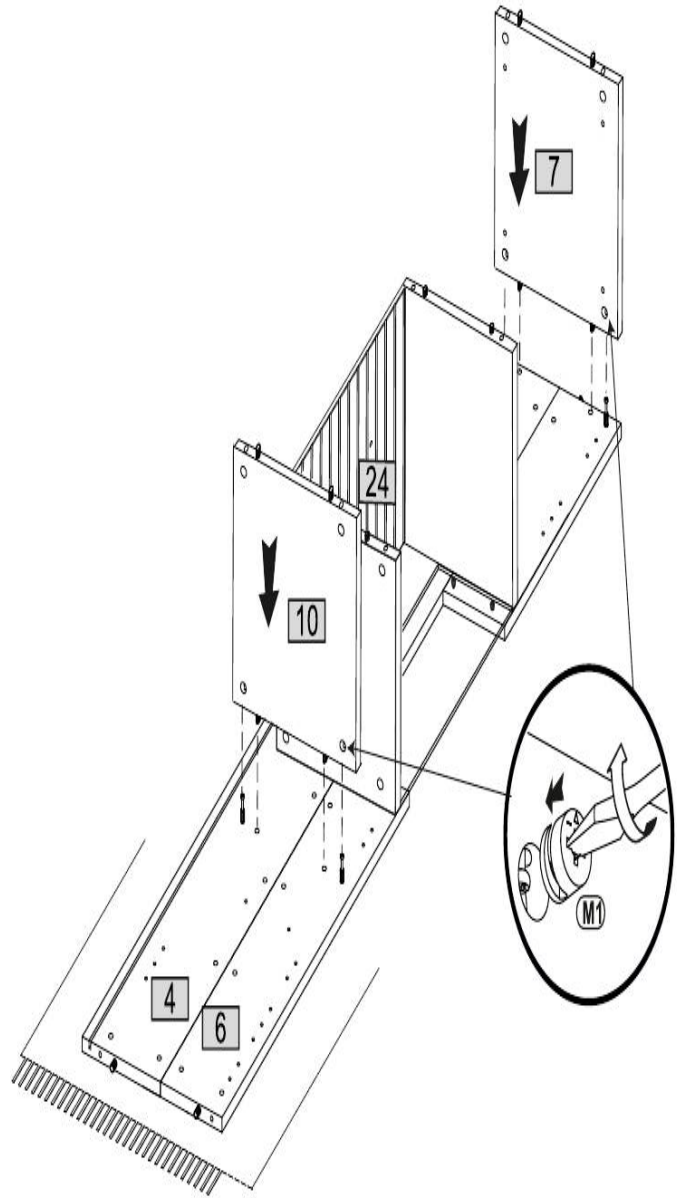

16

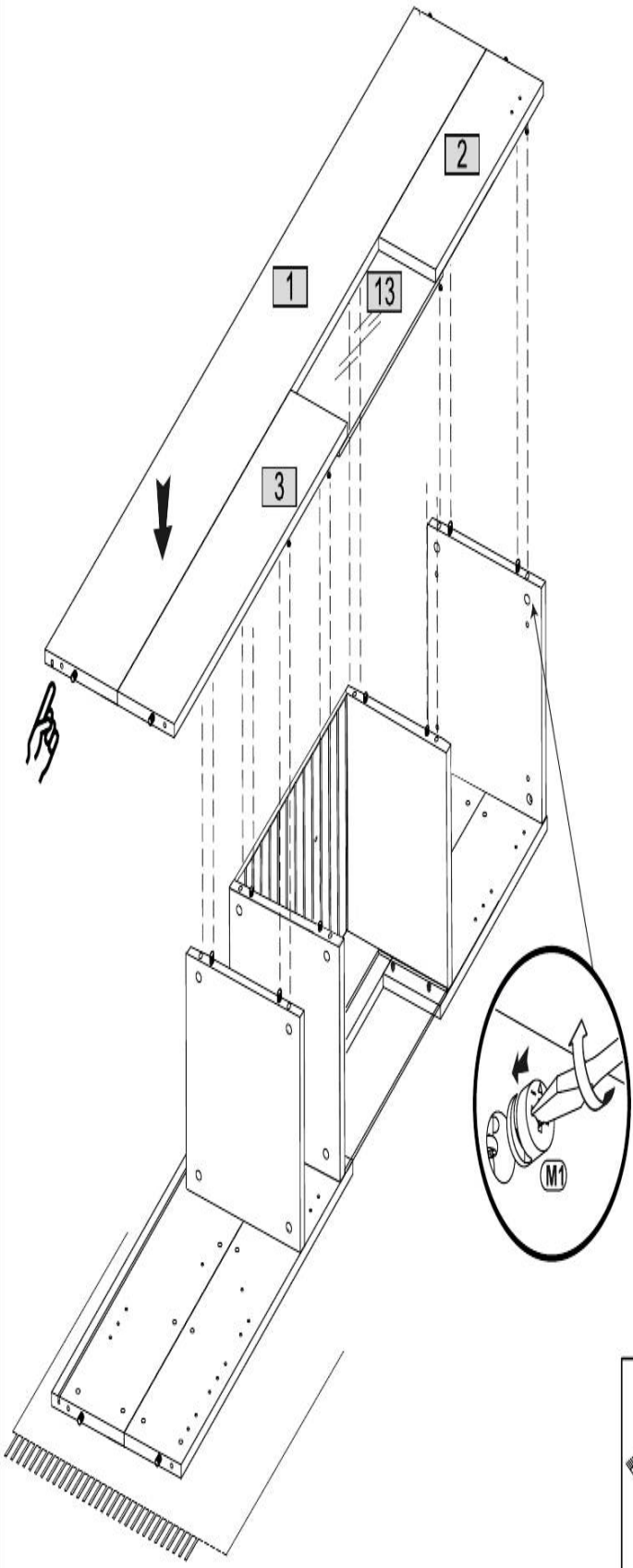

17

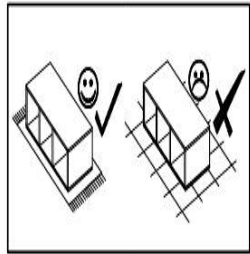
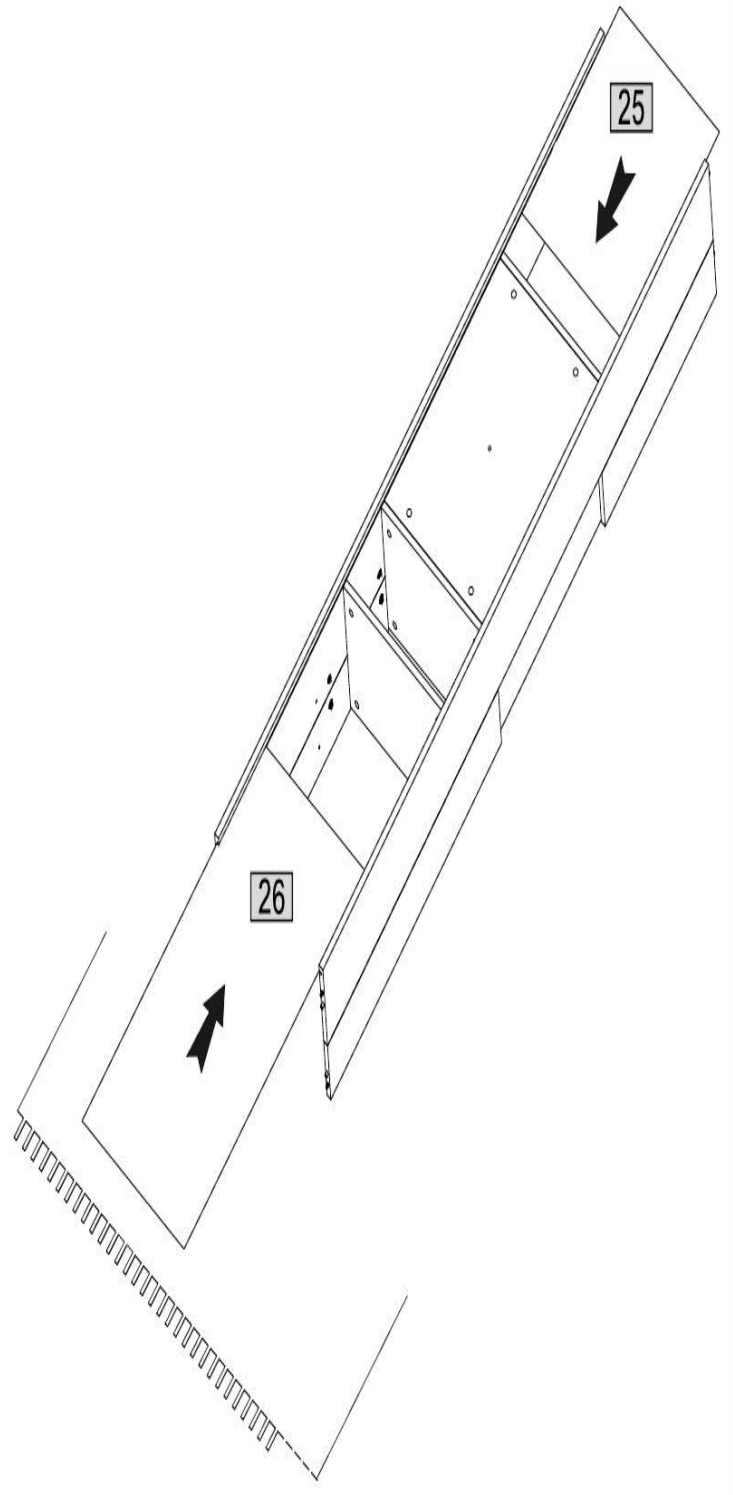

# 18

**M1**  
φ15x12  
x4

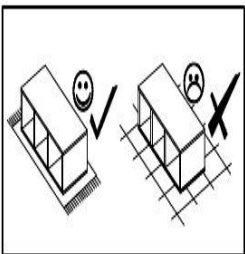
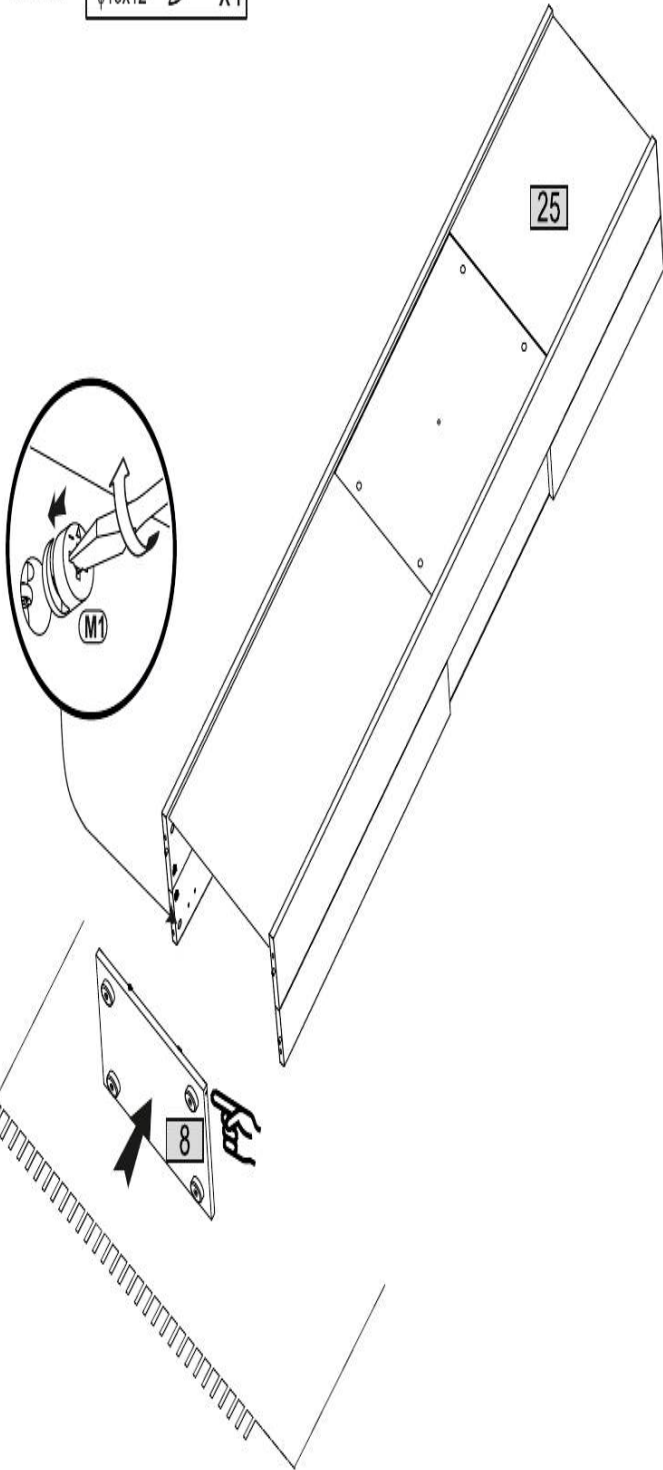

# 19

**J23**  
x14

**P2**  
3x16  
x6

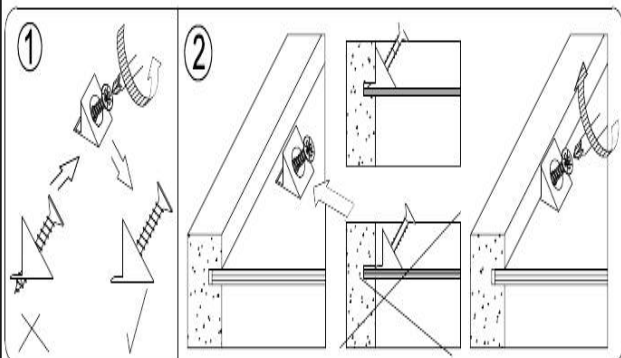
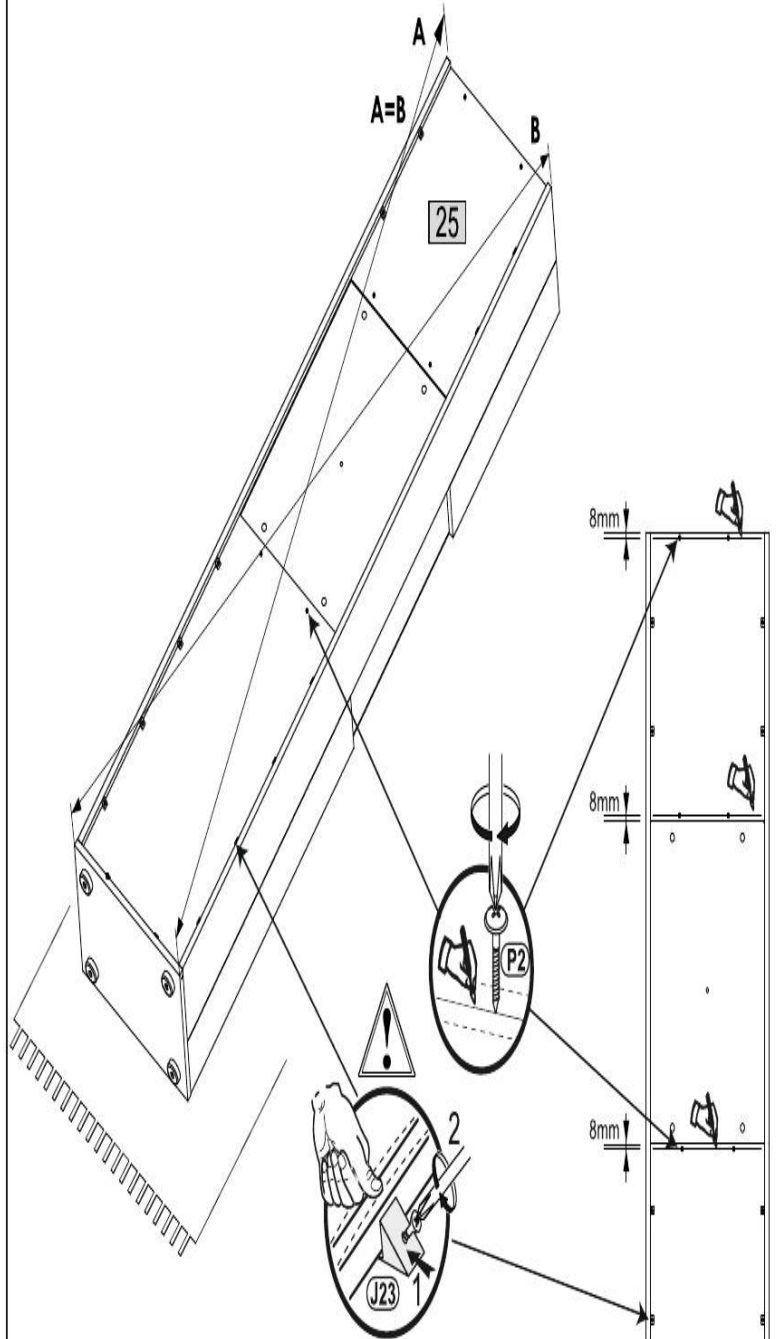
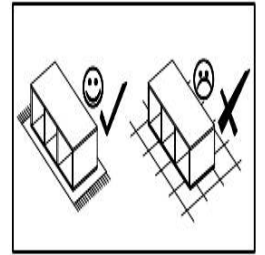

# 20

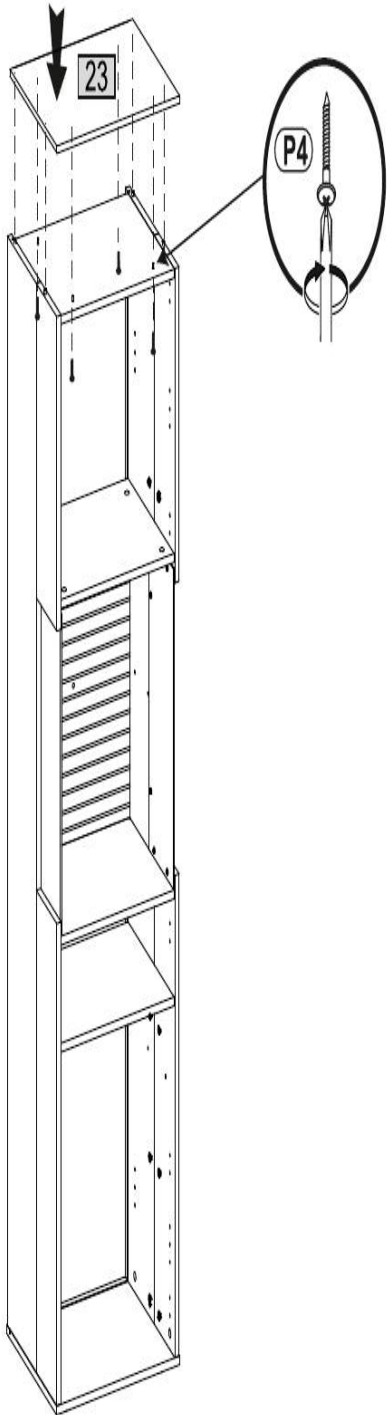
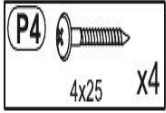

# 21

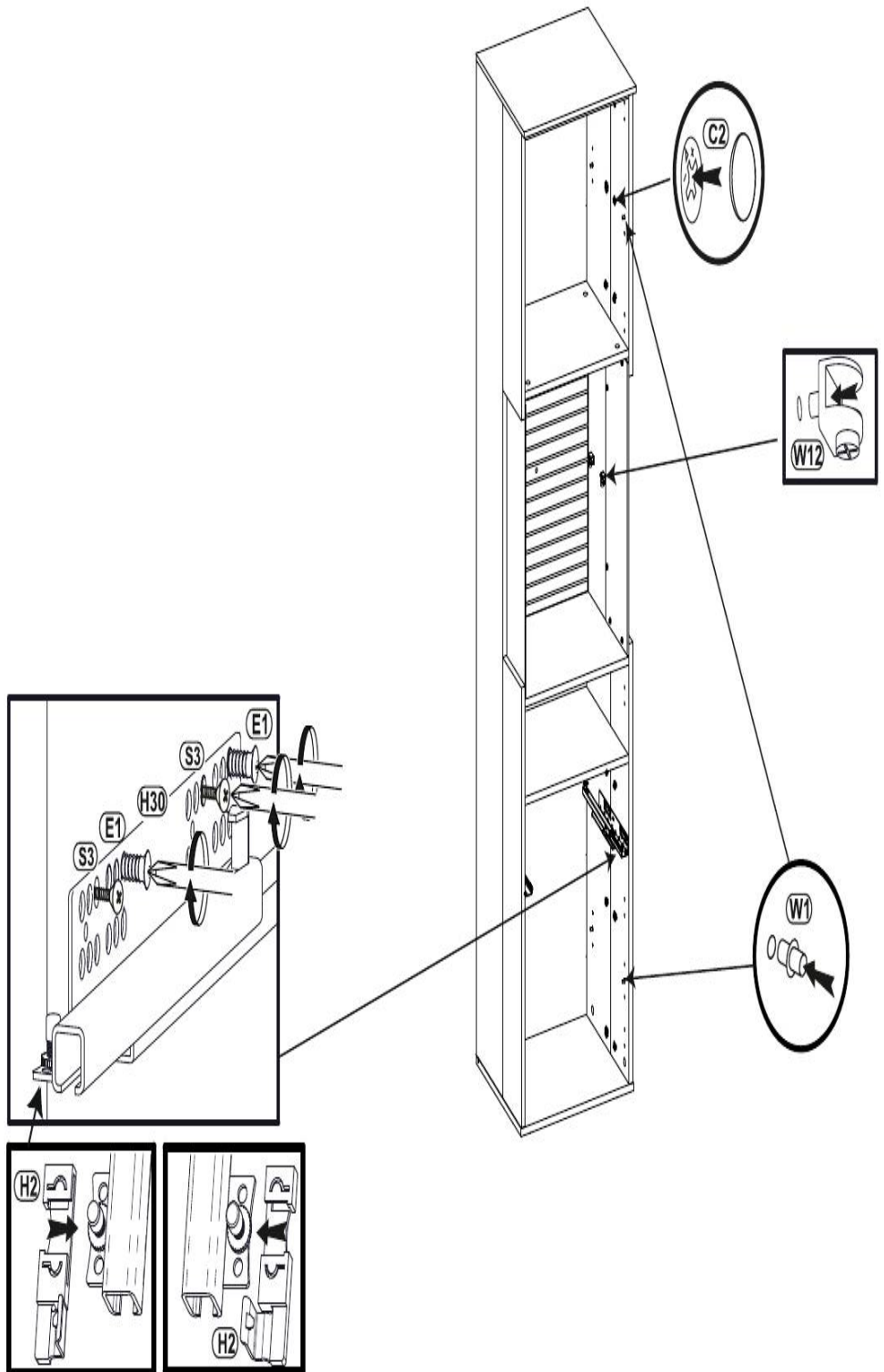
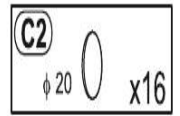
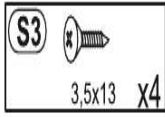
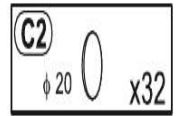
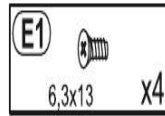
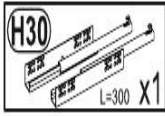

22

048 x1  
051 x1  
SOK-OSW  
-026-1

L6 x2

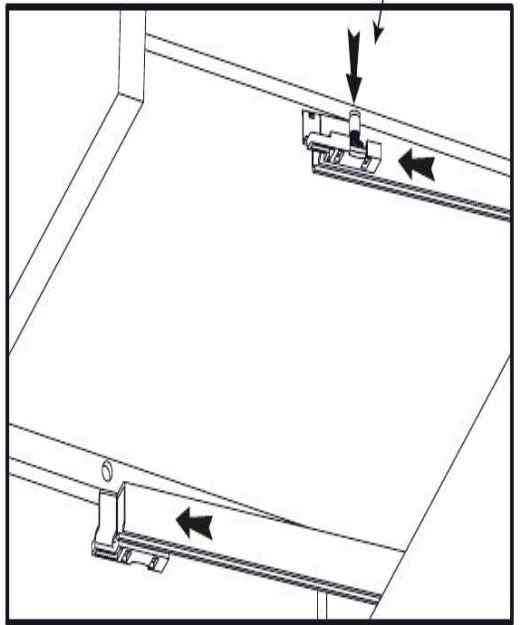
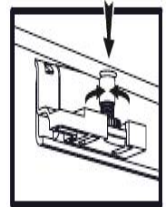
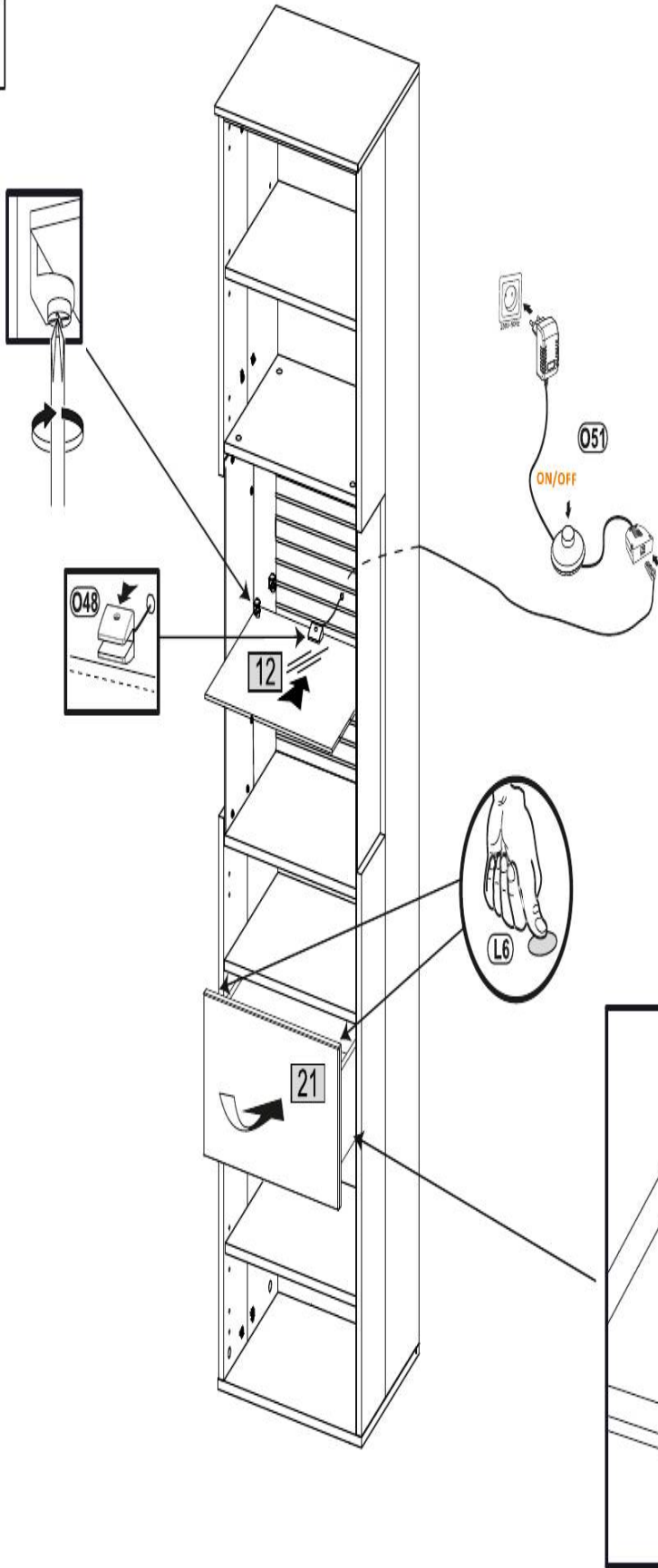
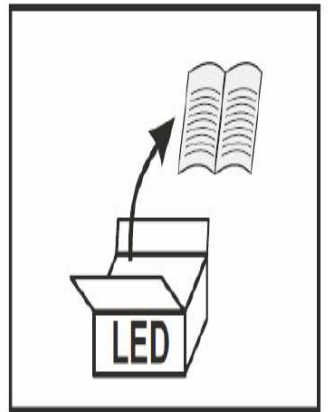
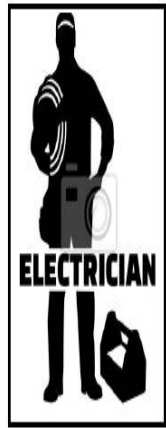

23

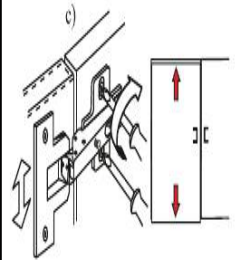
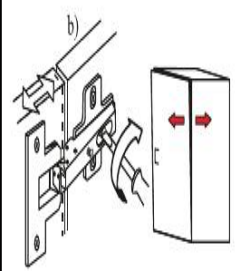
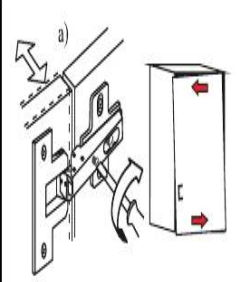
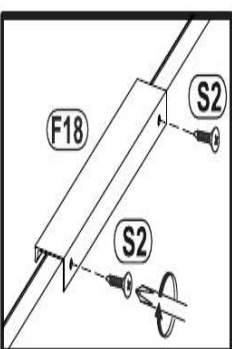
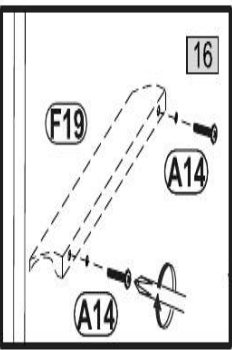
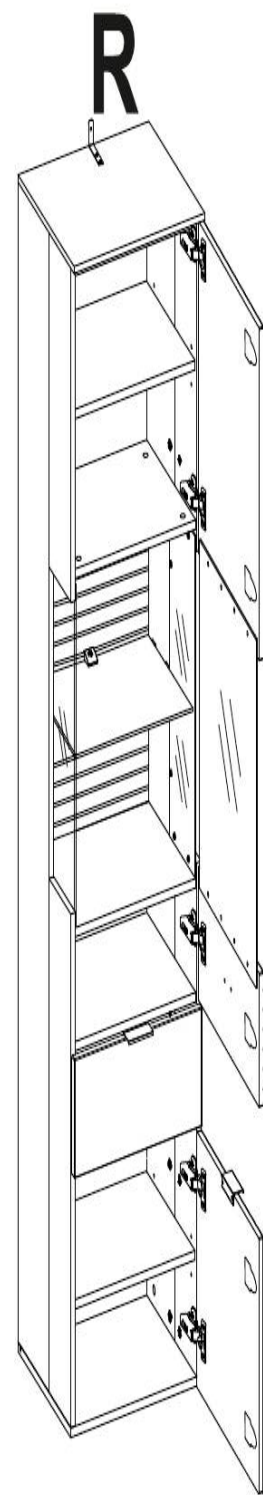
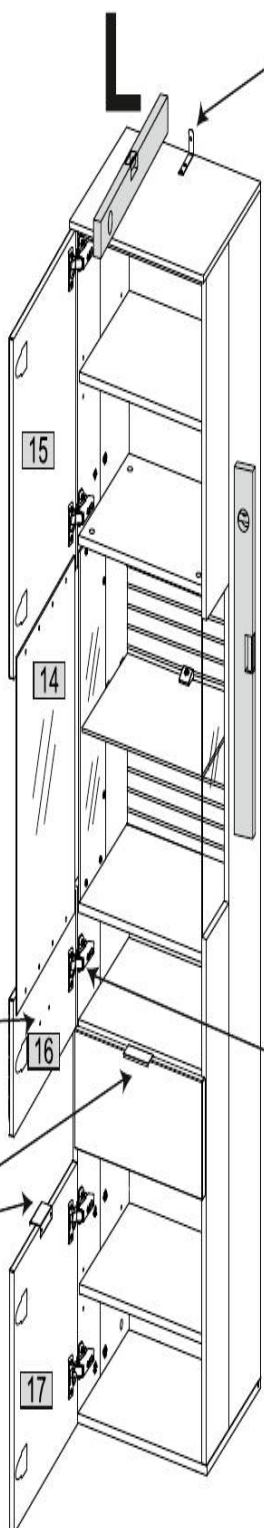
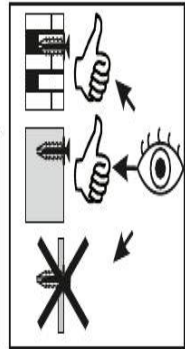
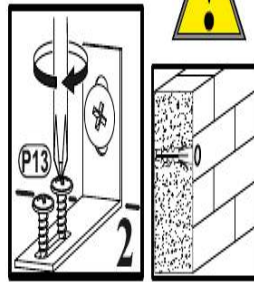
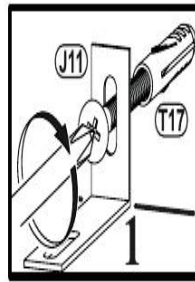
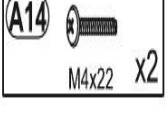
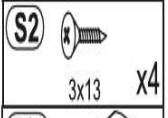
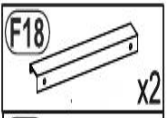
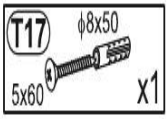
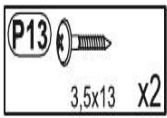
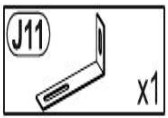

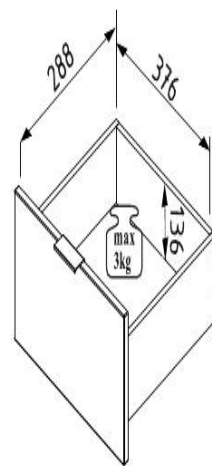
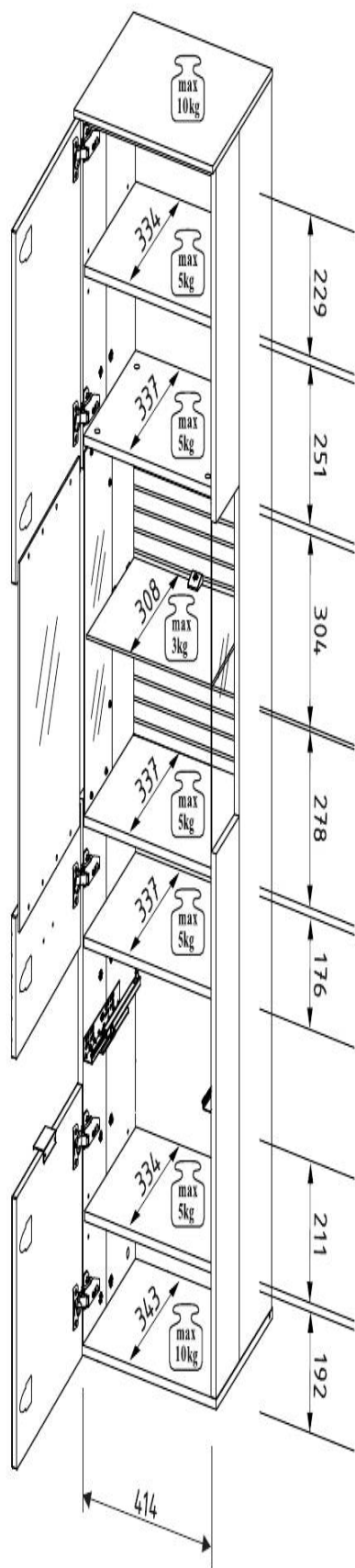

SOK-OSW-026-1

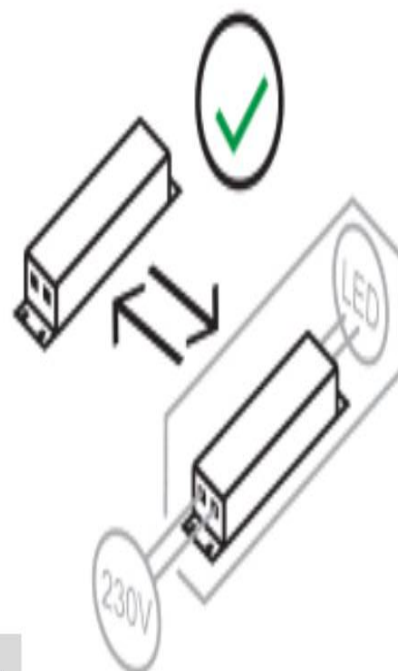
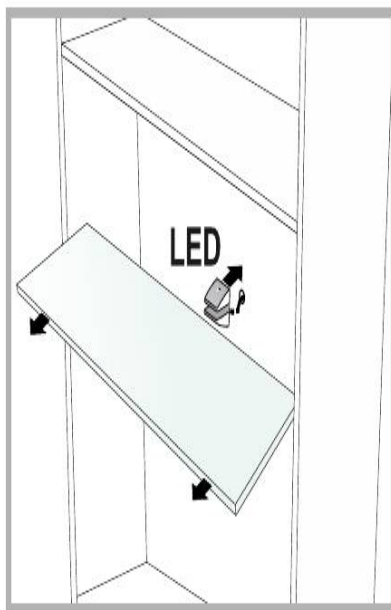
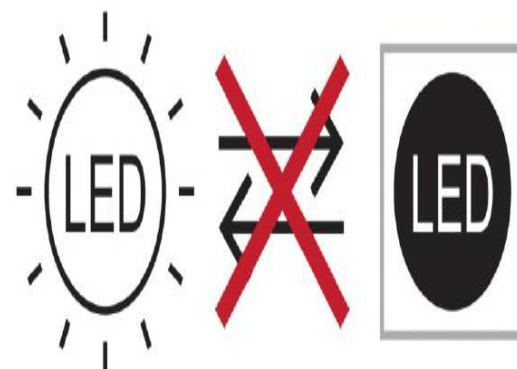

<b>PL-</b> Produkty te zawierają źródła światła, które ze względu na swoje właściwości nie podlegają rozporządzeniu (UE) 2019/2015	<b>DE-</b> Diese Produkte enthalten Lichtquellen, die aufgrund ihrer Eigenschaften nicht unter die Verordnung (EU) 2019/2015 fallen	<b>CS-</b> Tyto výrobky obsahují světelné zdroje, které vzhledem ke svým vlastnostem nespádají do oblasti působnosti nařízení (EU) 2019/2015
<b>DA-</b> Disse produkter indeholder lyskilder, som på grund af deres egenskaber er uden for anvendelsesområdet for forordning (EU) 2019/2015	<b>EL-</b> Αυτά τα προϊόντα περιέχουν πηγές φωτός οι οποίες, λόγω των ιδιοτήτων τους, δεν εμπίπτουν στο πεδίο εφαρμογής του κανονισμού (UE) 2019/2015	<b>EN-</b> These products contain light sources which, due to their properties, are out of the scope of Regulation (EU) 2019/2015
<b>ES-</b> Estos productos contienen fuentes de luz que, por sus propiedades, quedan fuera del ámbito de aplicación del Reglamento (UE) 2019/2015.	<b>ET-</b> Need tooted sisaldavad valgusallikaid, mis oma omaduste tõttu jäävad määruse (UE) 2019/2015 reguleerimisalast välja	<b>FI-</b> Nämä tuotteet sisältävät valonlähteitä, jotka ominaisuuksiensa vuoksi eivät kuulu asetuksen (EU) 2019/2015 soveltamisalaan
<b>FR-</b> Ces produits contiennent des sources lumineuses qui, en raison de leurs propriétés, n'entrent pas dans le champ d'application du règlement (UE) 2019/2015	<b>HU-</b> Ezek a termékek olyan fényforrásokat tartalmaznak, amelyek tulajdonságaik miatt nem tartoznak az (EU) 2019/2015 rendelet hatálya alá	<b>IT-</b> Questi prodotti contengono sorgenti luminose che, per le loro proprietà, esulano dal campo di applicazione del Regolamento (UE) 2019/2015
<b>LT-</b> Šiuose gaminių ypa šviesos šaltiniai, kurie dėl savo savybių nepatenka į Reglamento (UE) 2019/2015 taikymo sritį	<b>LV-</b> Šie produkti satur gaismas avotus, kas to īpašību dēļ ir ārpus Regulas (UE) 2019/2015 darbības jomas	<b>RU-</b> Эти продукты содержат источники света, которые из-за своих свойств не подпадают под действие Регламента (ЕС) 2019/2015.
<b>PT-</b> Estes produtos contêm fontes de luz que, devido às suas propriedades, estão fora do âmbito do Regulamento (UE) 2019/2015	<b>RO-</b> Aceste produse conțin surse de lumină care, datorită proprietăților lor, nu intră în domeniul de aplicare al Regulamentului (UE) 2019/2015	<b>NL-</b> Deze producten bevatten lichtbronnen die vanwege hun eigenschappen buiten het toepassingsgebied van Verordening (EU) 2019/2015 vallen
<b>SK-</b> Tieto výrobky obsahujú svetelné zdroje, ktoré vzhľadom na svoje vlastnosti nepatria do rozsahu pôsobnosti nariadenia (EÚ) 2019/2015	<b>SLO-</b> Ti izdelki vsebujejo svetlobne vire, ki zaradi svojih lastnosti ne spadajo na področje uporabe Uredbe (EU) 2019/2015	<b>SV-</b> Dessa produkter innehåller ljuskällor som på grund av sina egenskaper inte omfattas av förordning (EU) 2019/2015
<b>TR-</b> Bu ürünler, özellikleri nedeniyle (UE) 2019/2015 Yönetmeliğinin kapsamı dışında kalan ışık kaynakları içerir.	<b>HR-</b> Ovi proizvodi sadrže izvore svjetlosti koji zbog svojih svojstava nisu obuhvaćeni Uredbom (EU) 2019/2015	<b>BG-</b> Тези продукти съдържат източници на светлина, които поради своите свойства са извън обхвата на Регламент (ЕС) 2019/2015

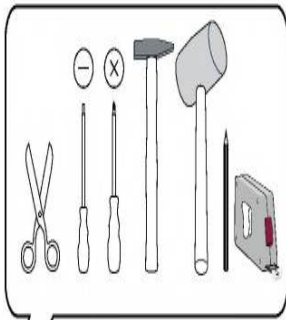
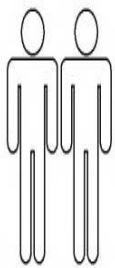



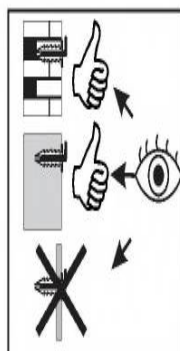
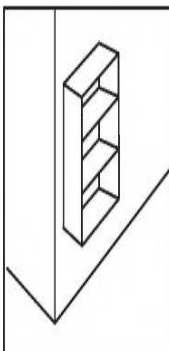
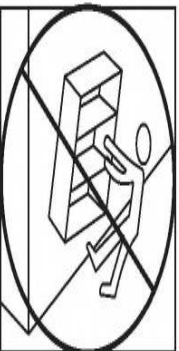
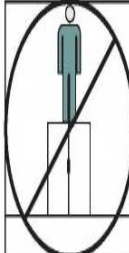
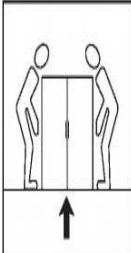
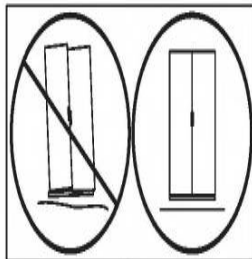
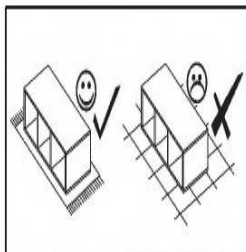
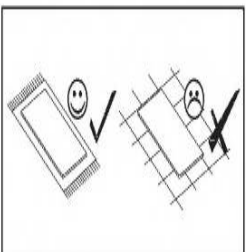
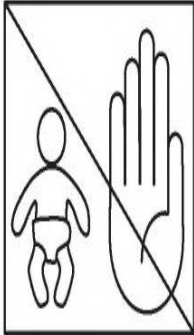
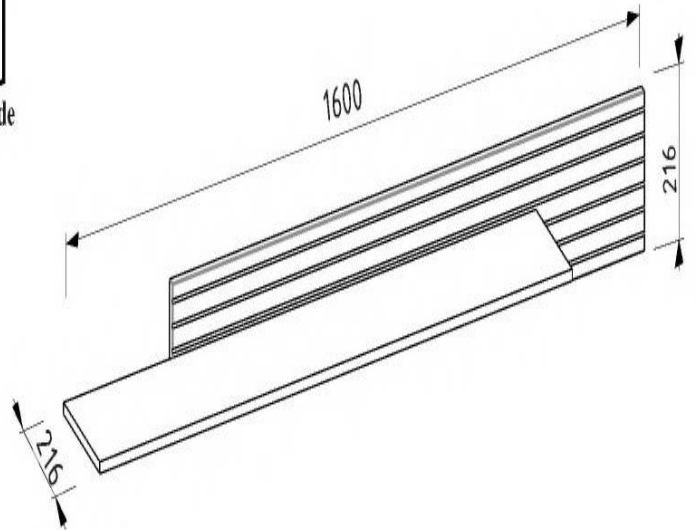
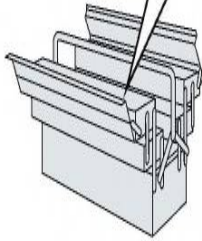

info@bega-consult.de

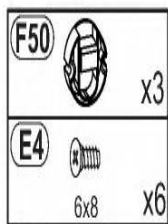
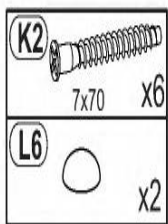

<https://quefairedemesdechets.fr>



Nr				pcs	
1	1300	200	16	1	1
2	1300	216	16	1	1

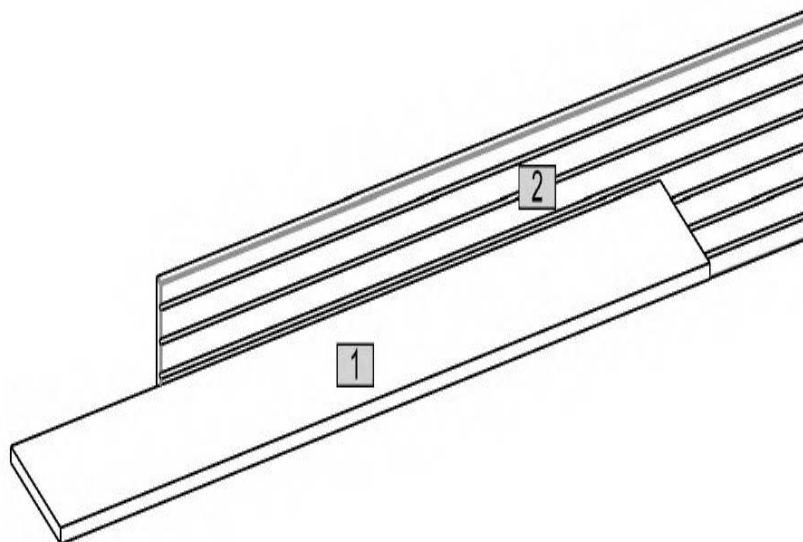
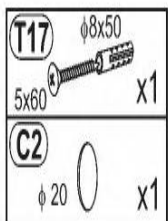
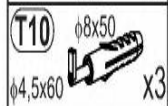

1

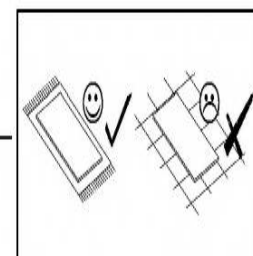
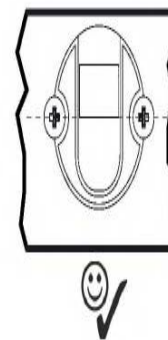
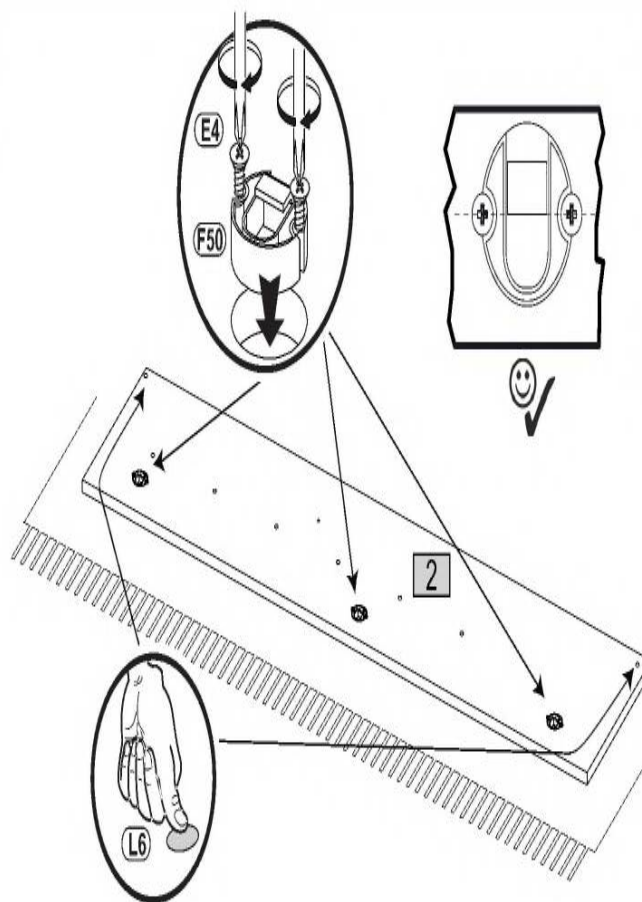
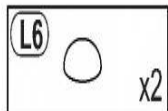
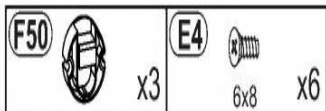

2

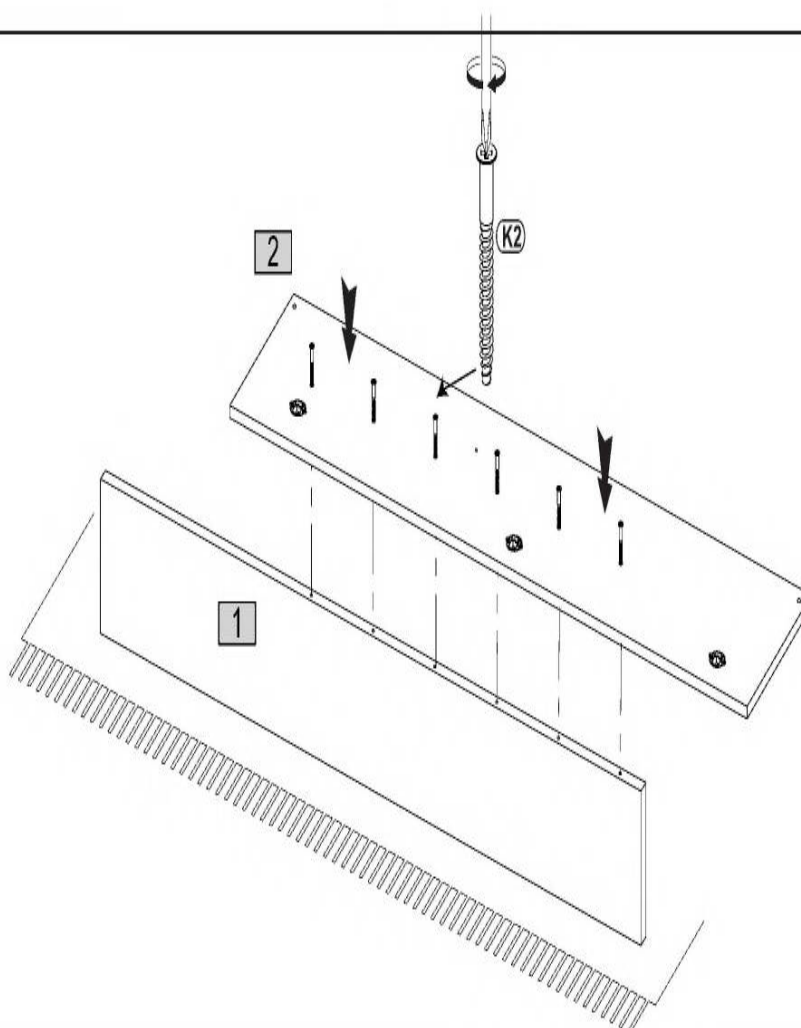
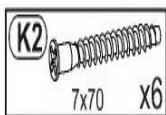

3

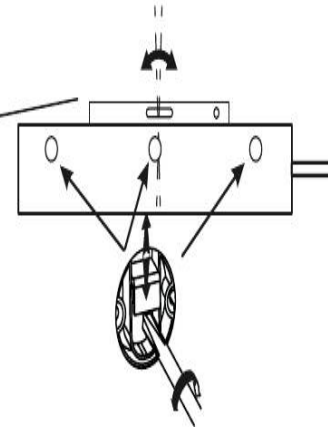
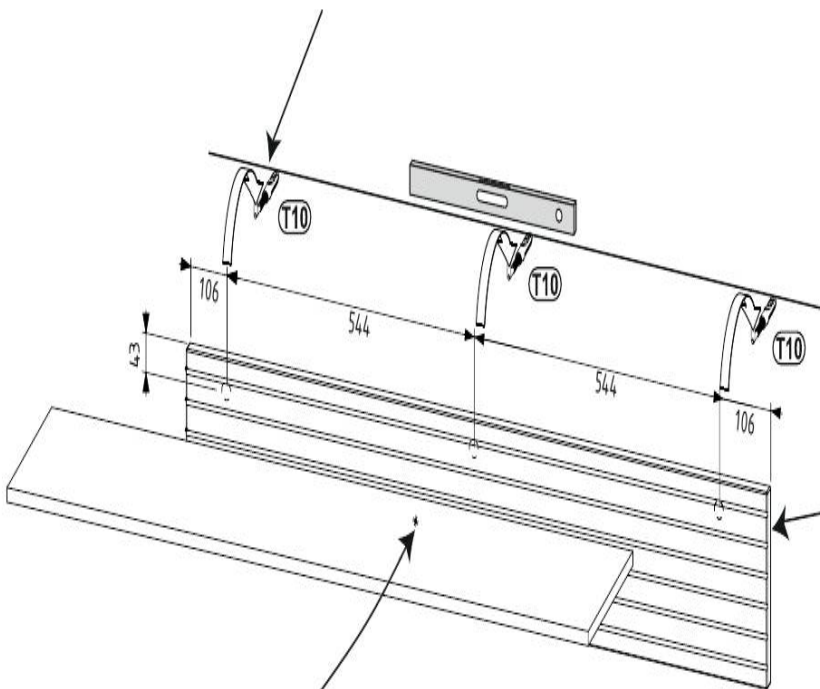
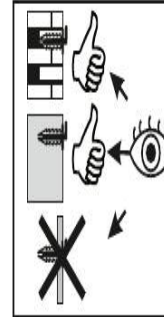
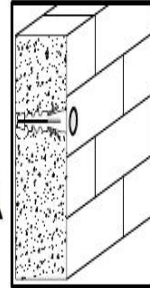
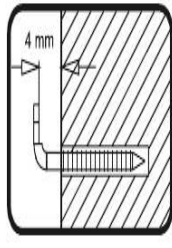
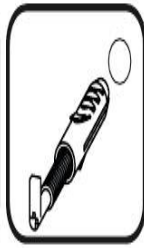
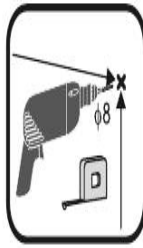
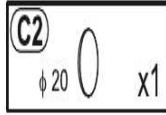
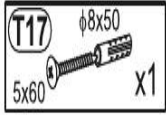
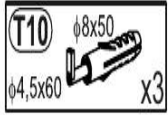

OPTIONAL

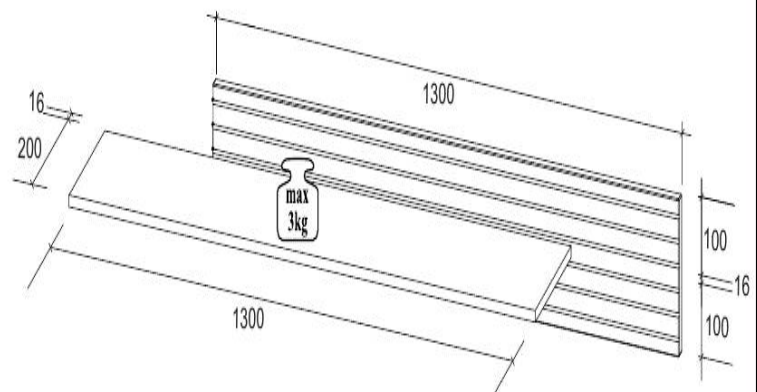
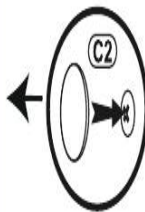
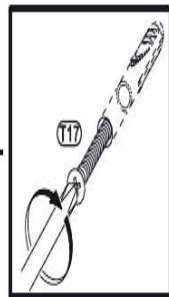
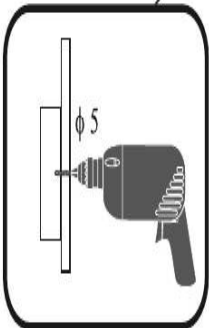

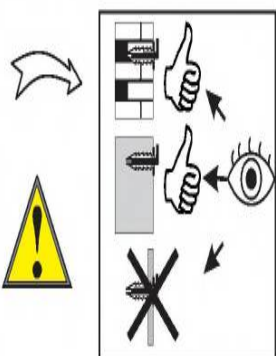
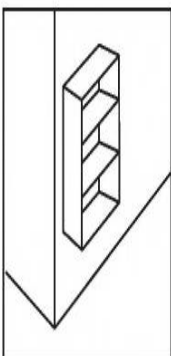
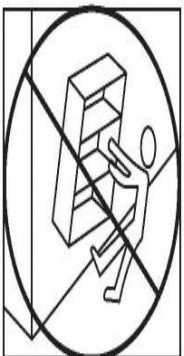
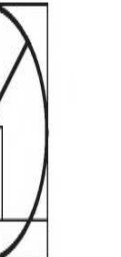
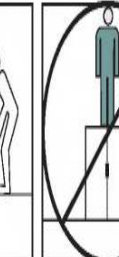
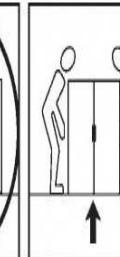
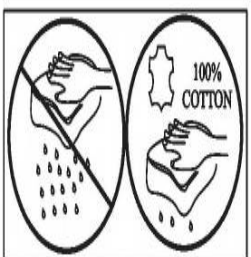
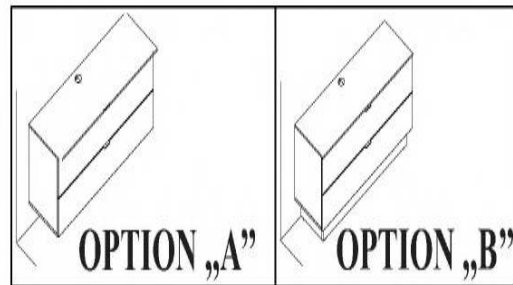
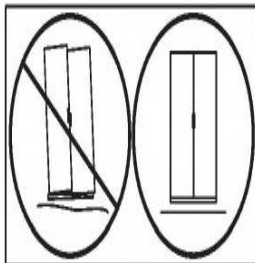
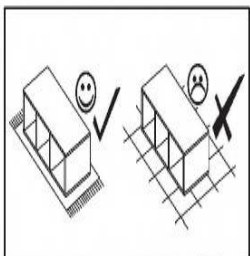
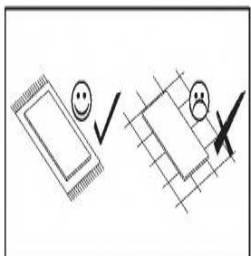
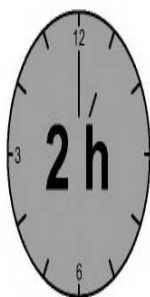
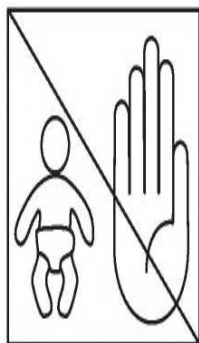
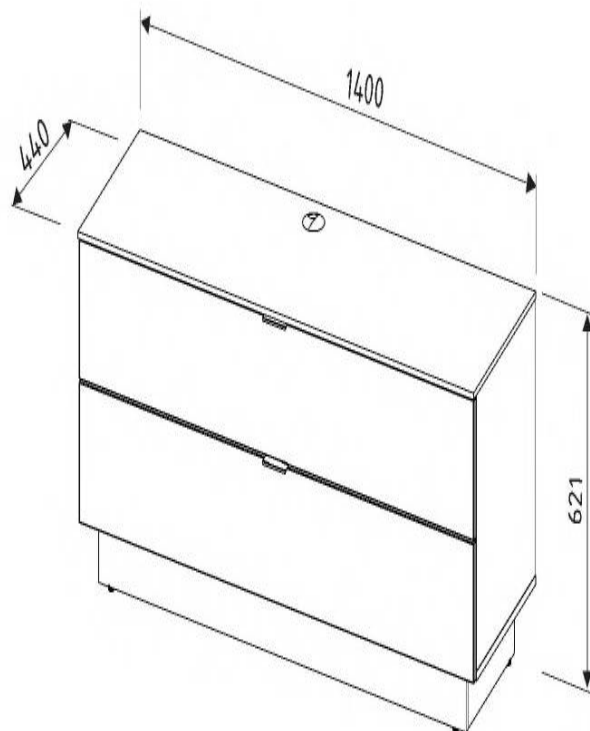
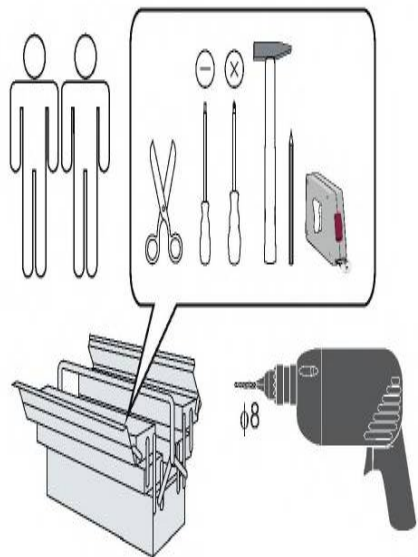

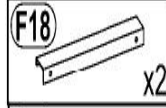
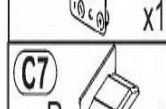
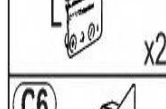
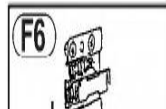
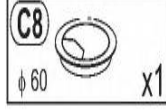
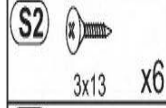
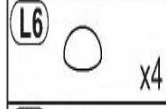
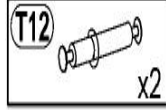
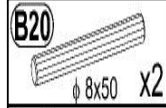
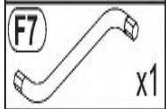
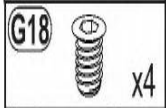
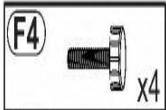
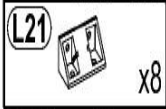
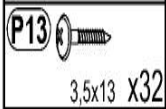
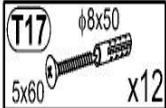
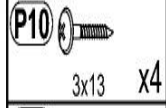
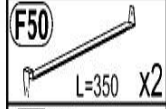
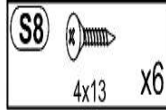
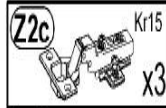
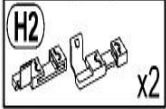
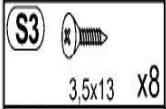
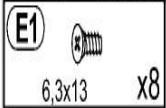
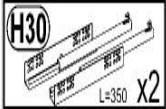
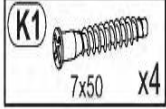
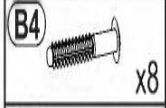
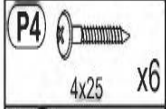
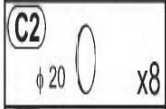
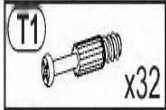
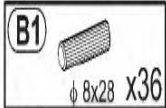

Nr	↙	↖	↗	pcs	☐
1	477	418	16	1	1
2	477	418	16	1	1
3	461	399	16	1	1
4	1366	399	16	1	2
5	1400	418	16	1	1
6	675	398	16	1	1
7	1400	440	12	1	2
8	1366	80	16	2	2
9	1266	110	16	1	2
10	326	110	16	1	1
11	1300	110	16	1	2
12	326	110	16	1	1
13	1396	242	16	1	1
14	350	140	12	2	1
15	350	140	12	2	1
16	635	140	12	2	1
17	1396	242	16	1	2
18	645	348	2	2	1
19	675	398	16	1	1

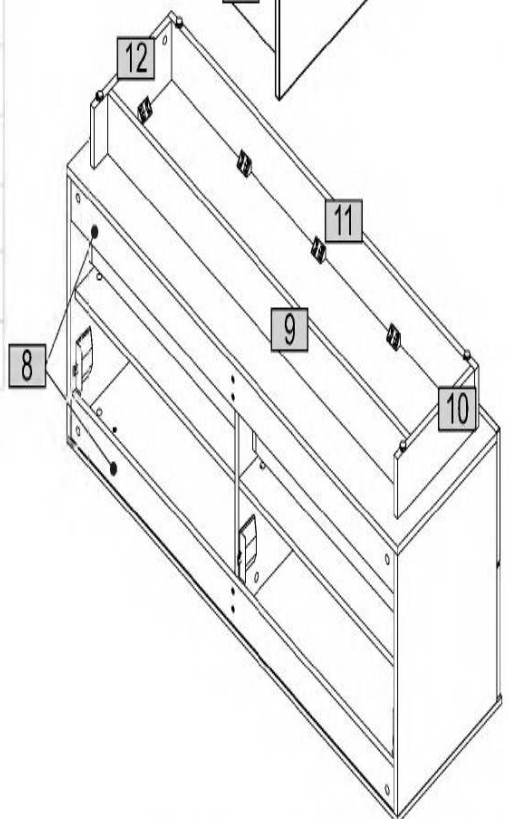
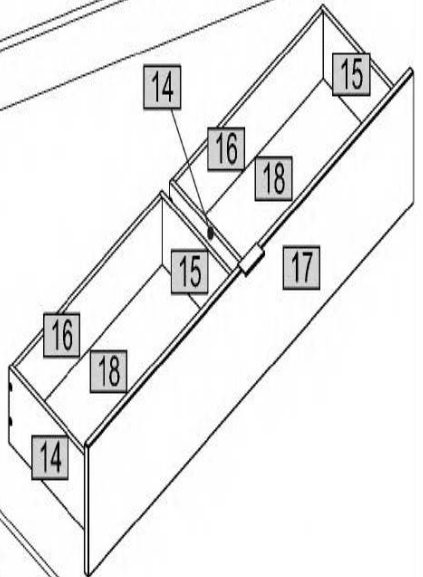
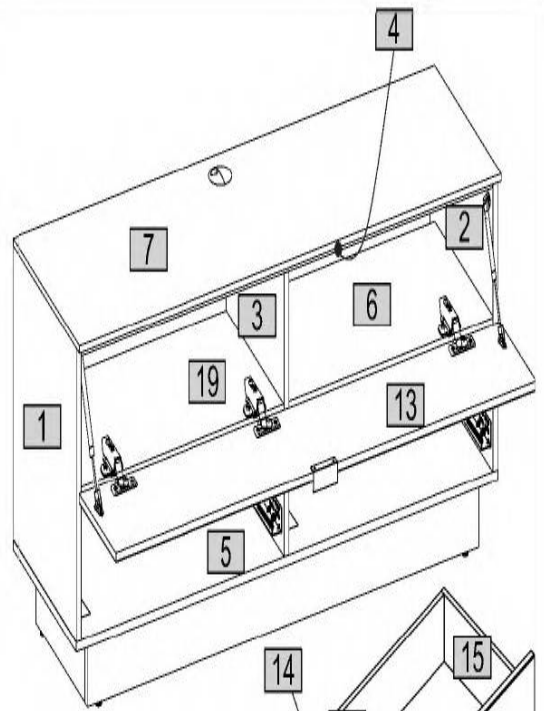

0 10 20 30 40 50 60 70 80 90 100 110 120 130 140 150 160 170 180 190 200





5

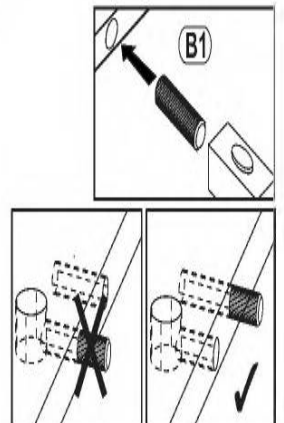
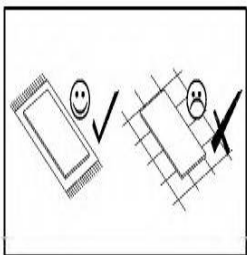
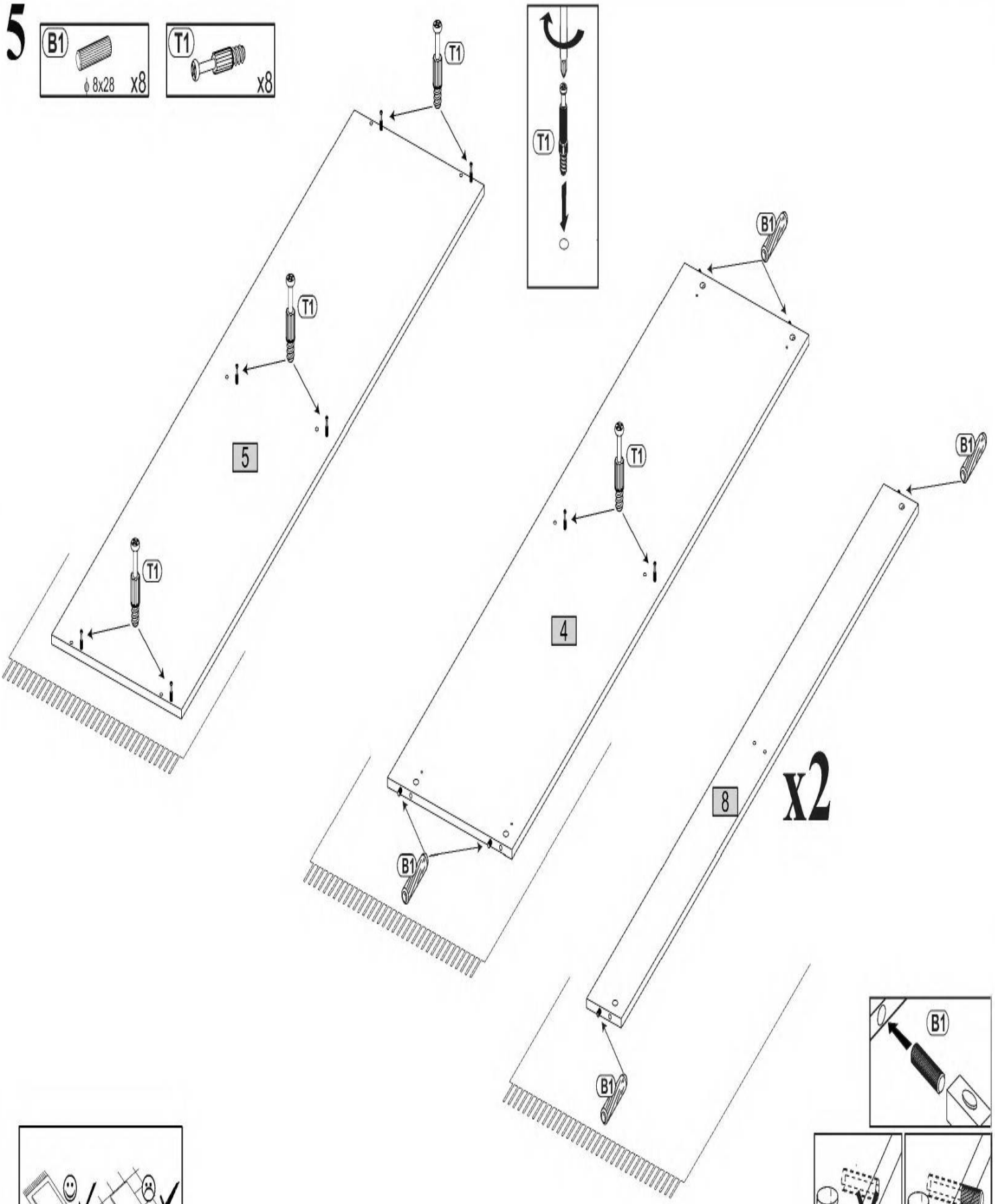
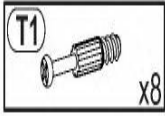
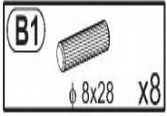

6

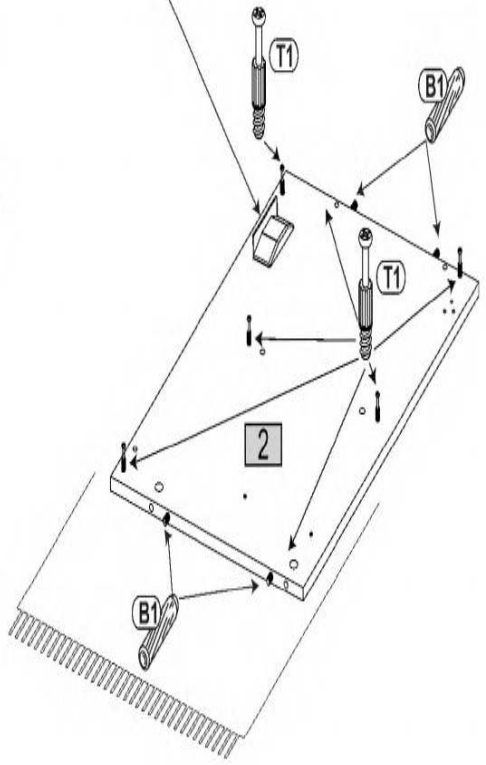
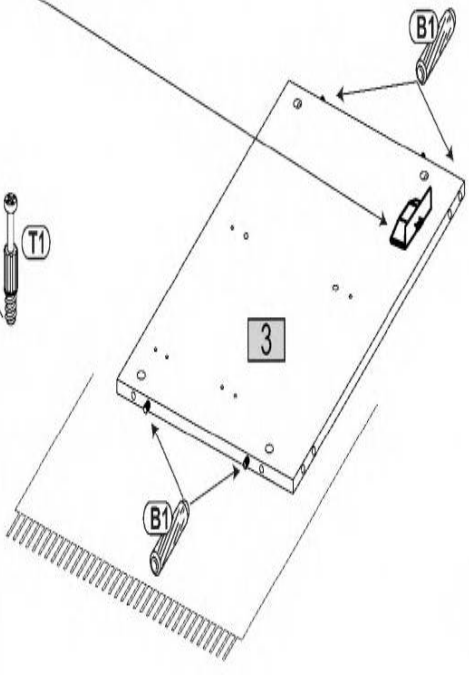
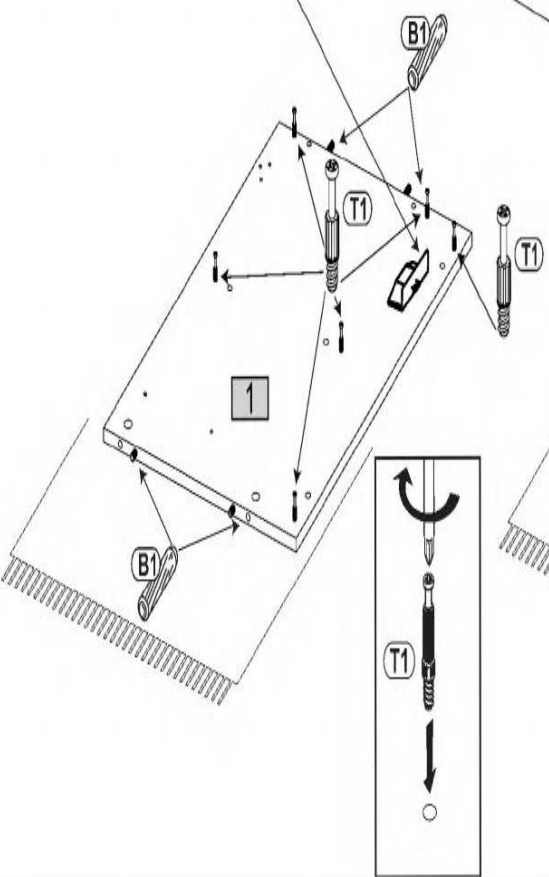
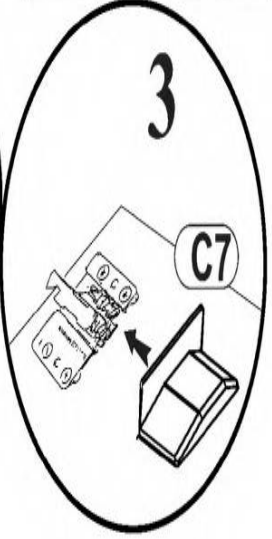
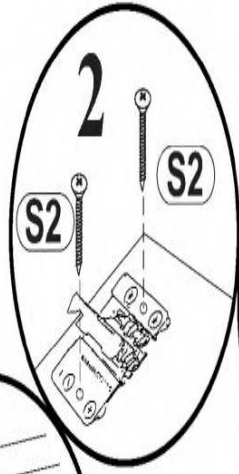
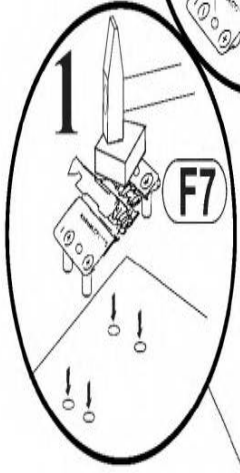
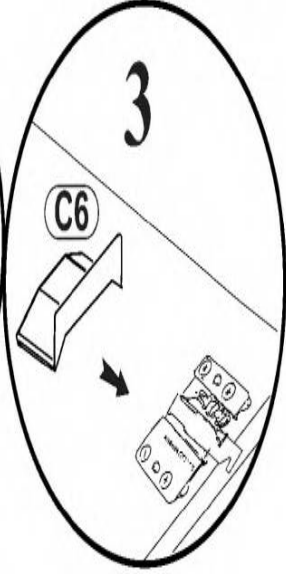
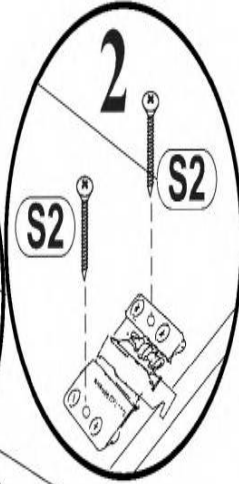
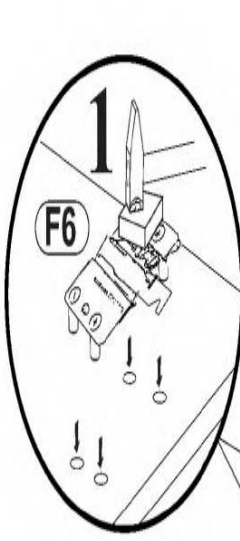
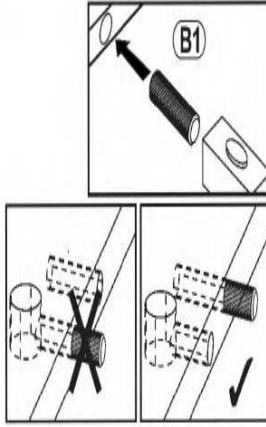
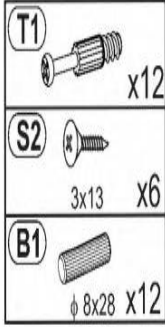
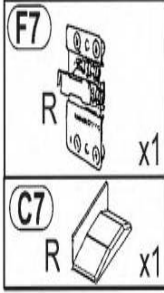
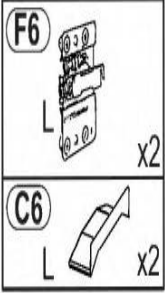

7

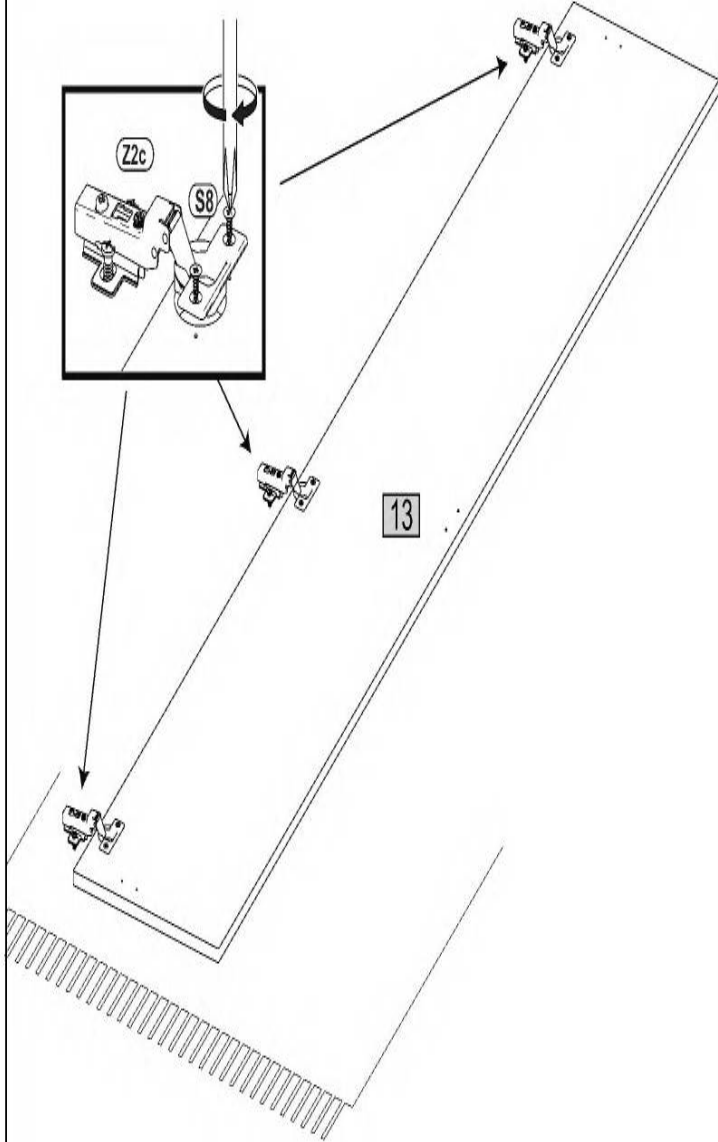
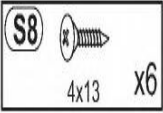

8

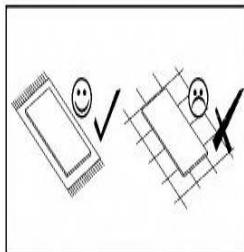
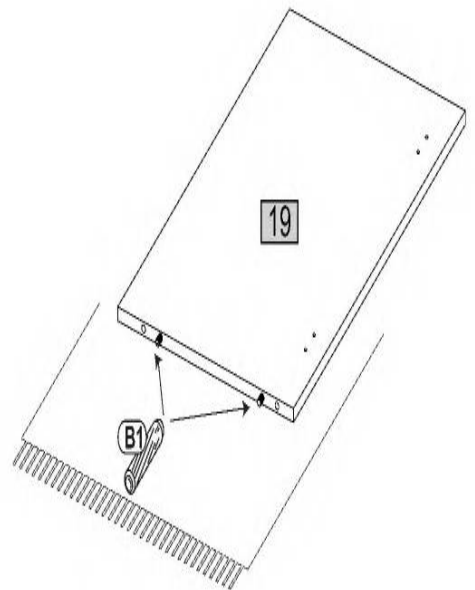
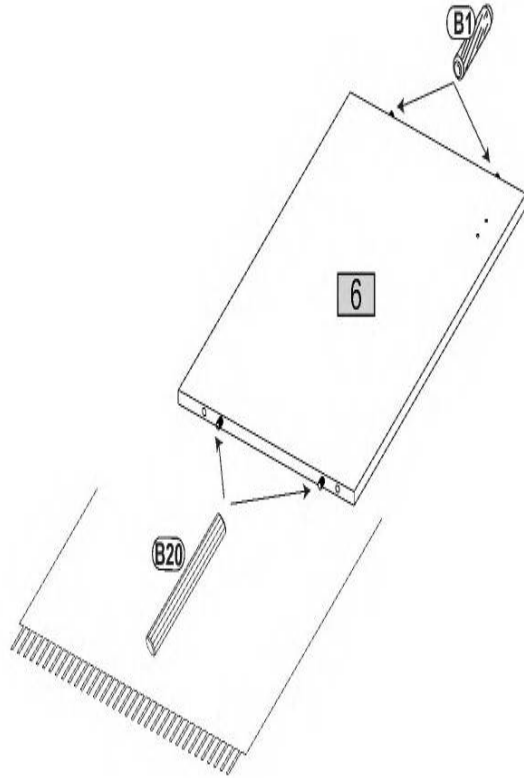
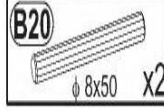
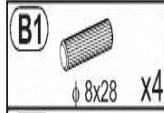

9

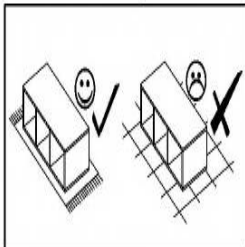
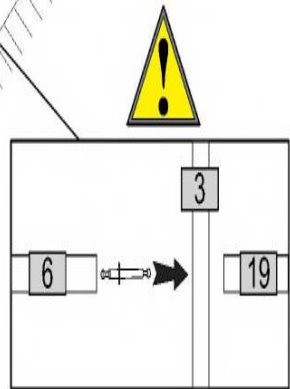
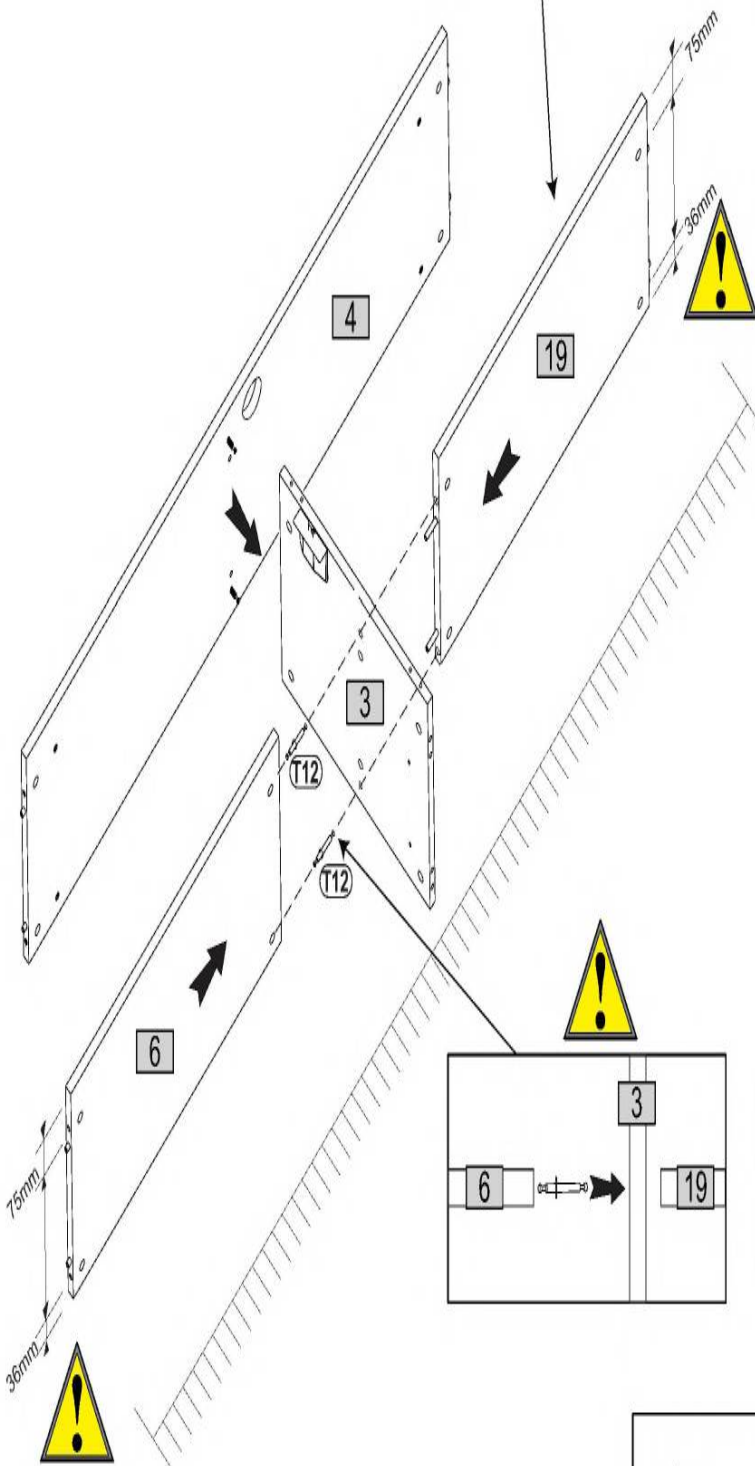
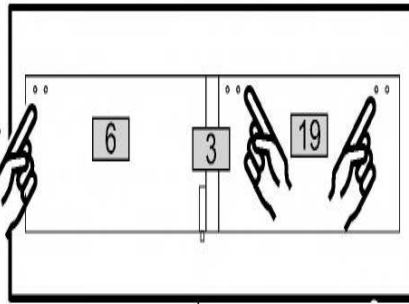
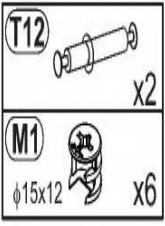

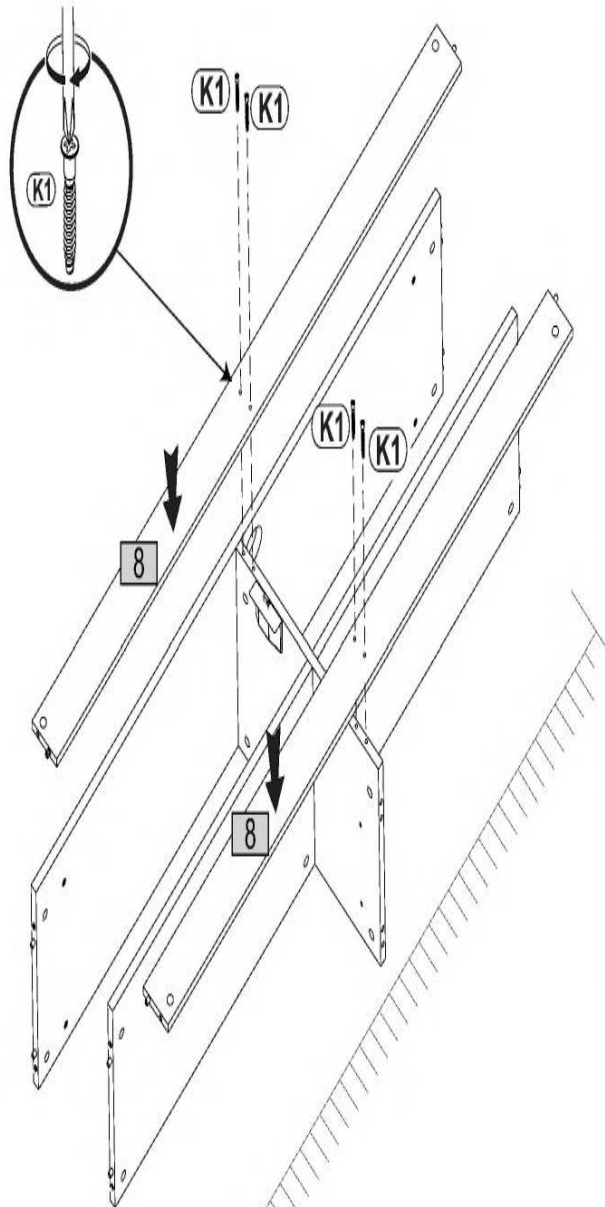
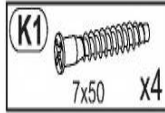

10

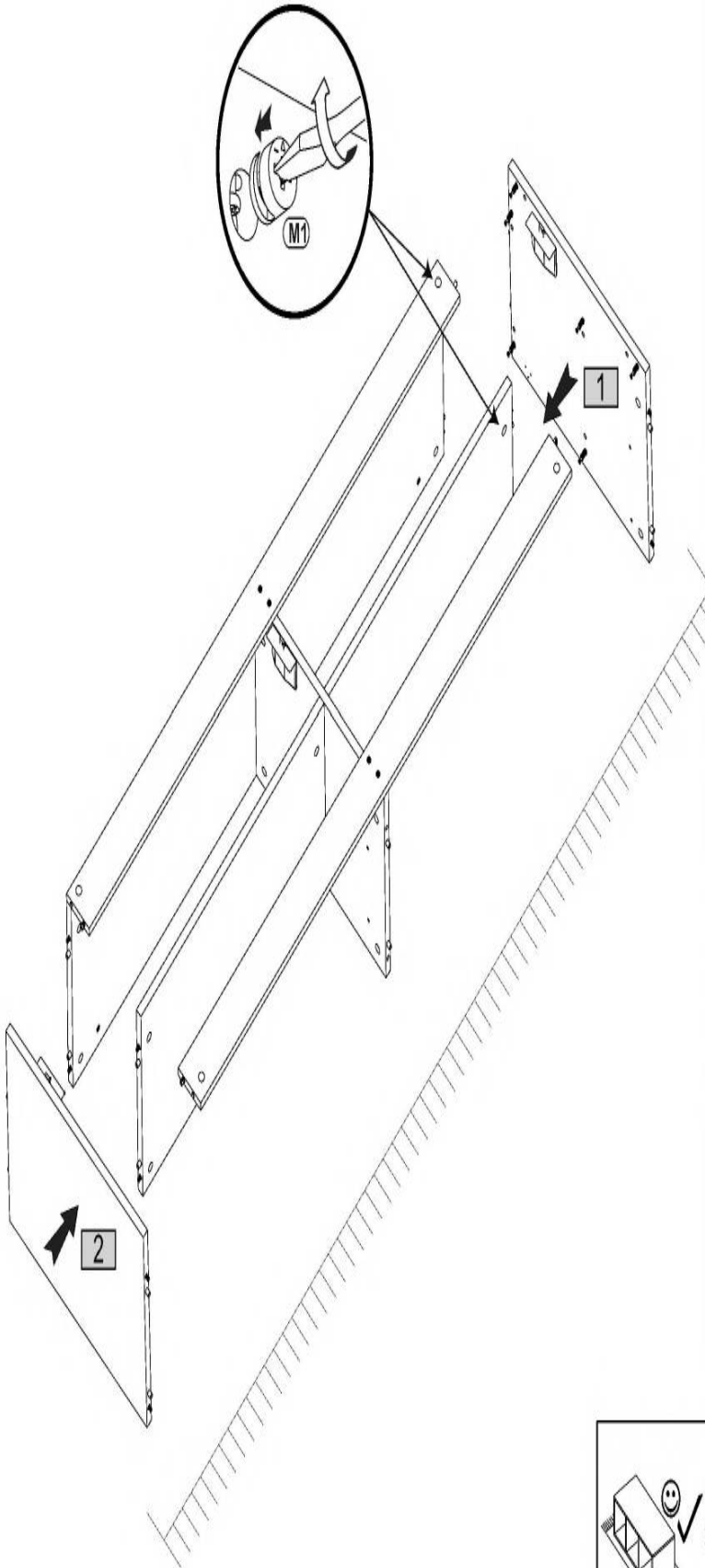

11   $\phi 15 \times 12$   x12



12   $\phi 15 \times 12$   x6

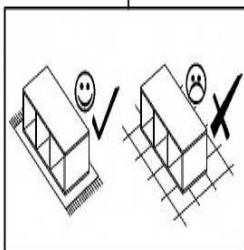
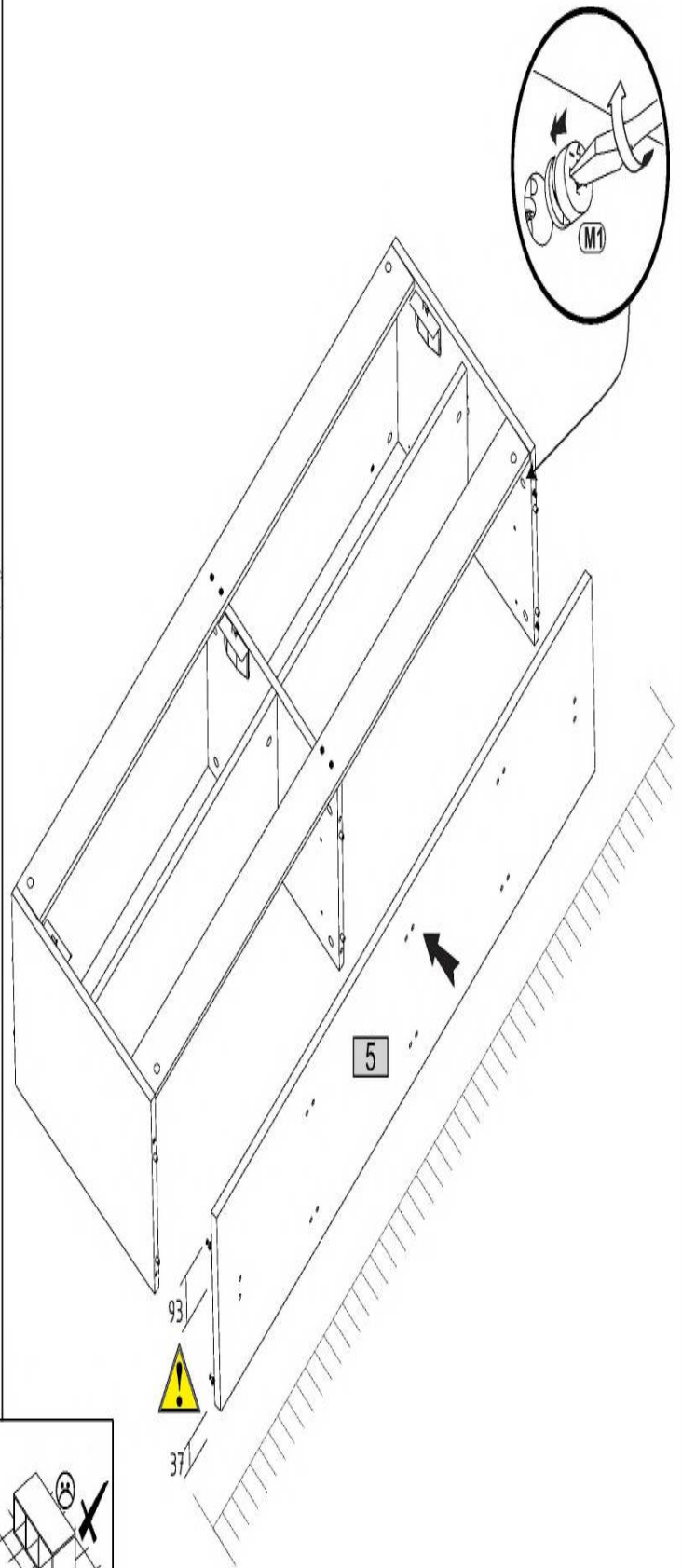

13

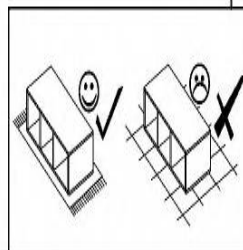
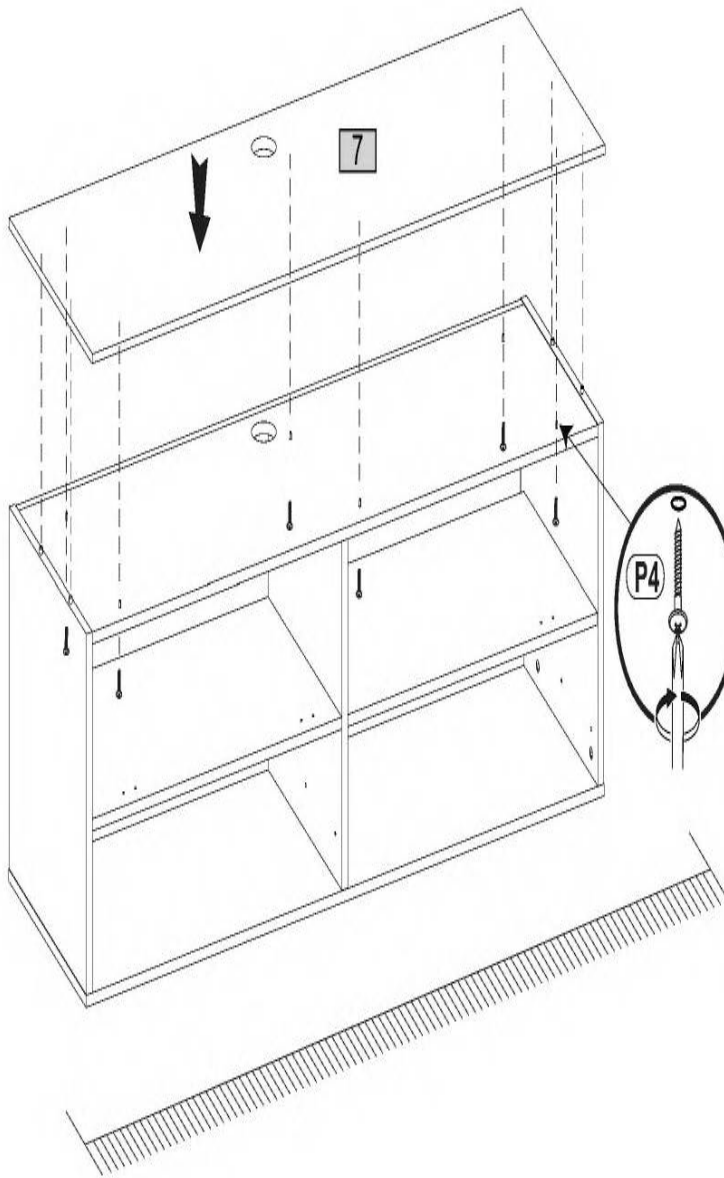
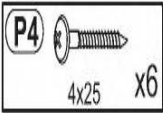

14

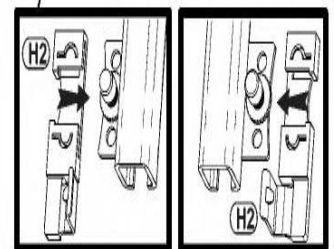
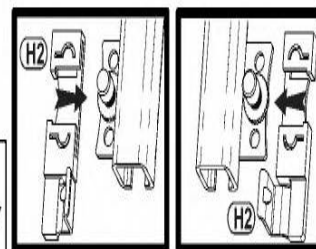
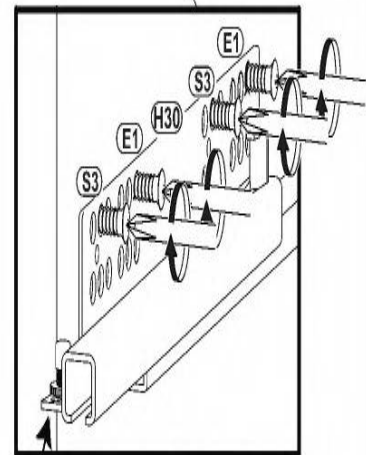
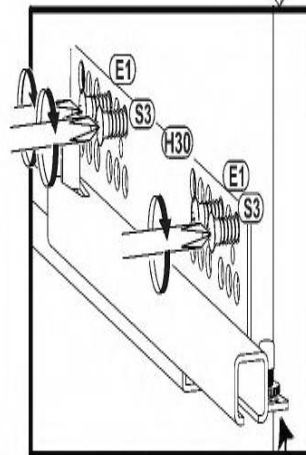
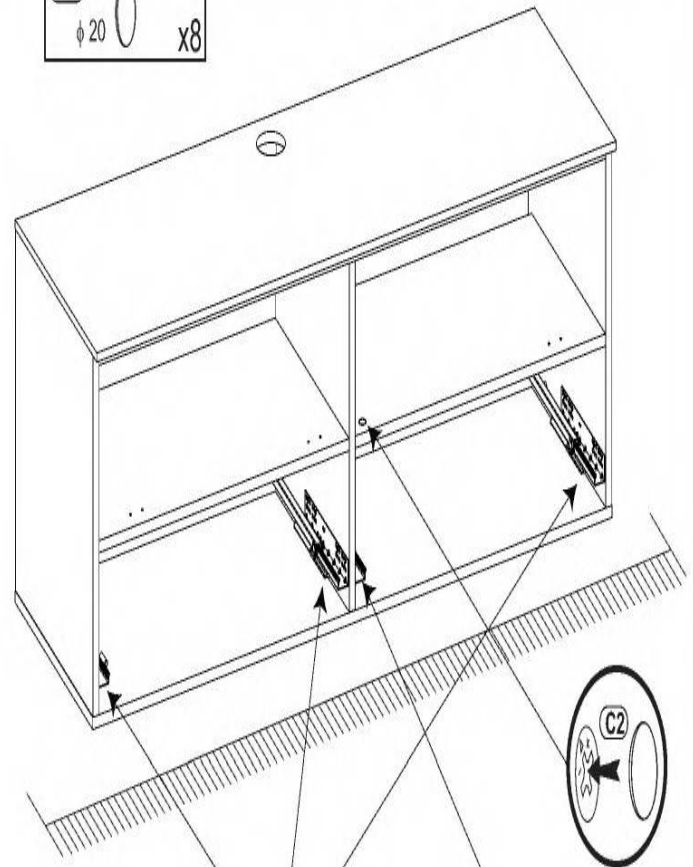
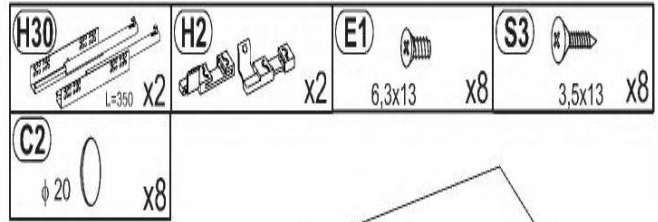

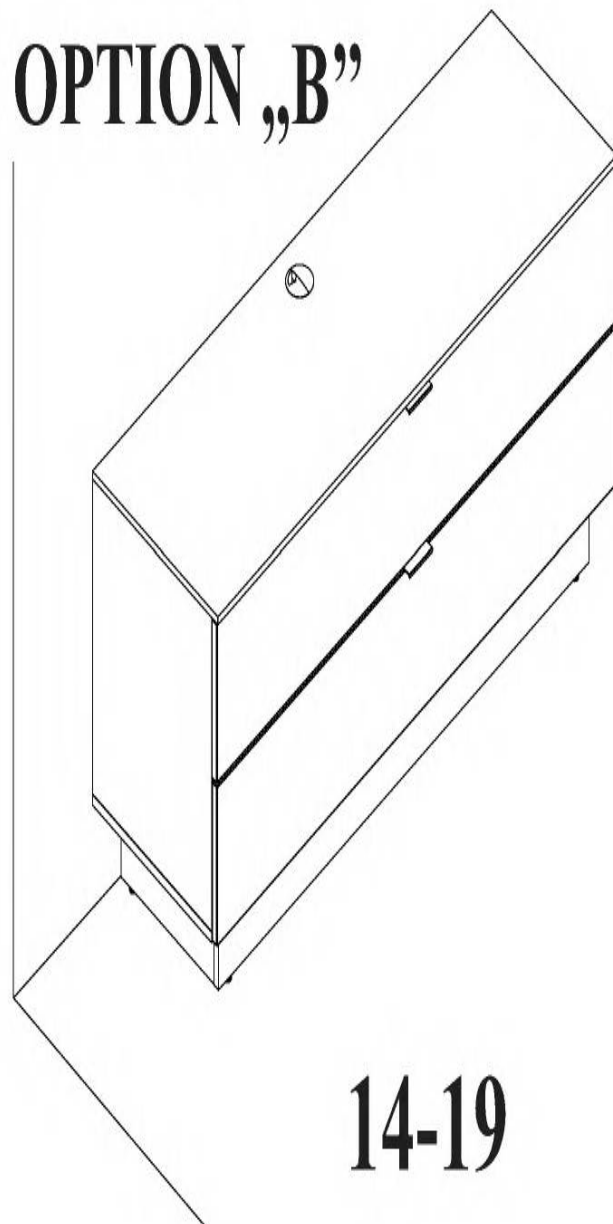
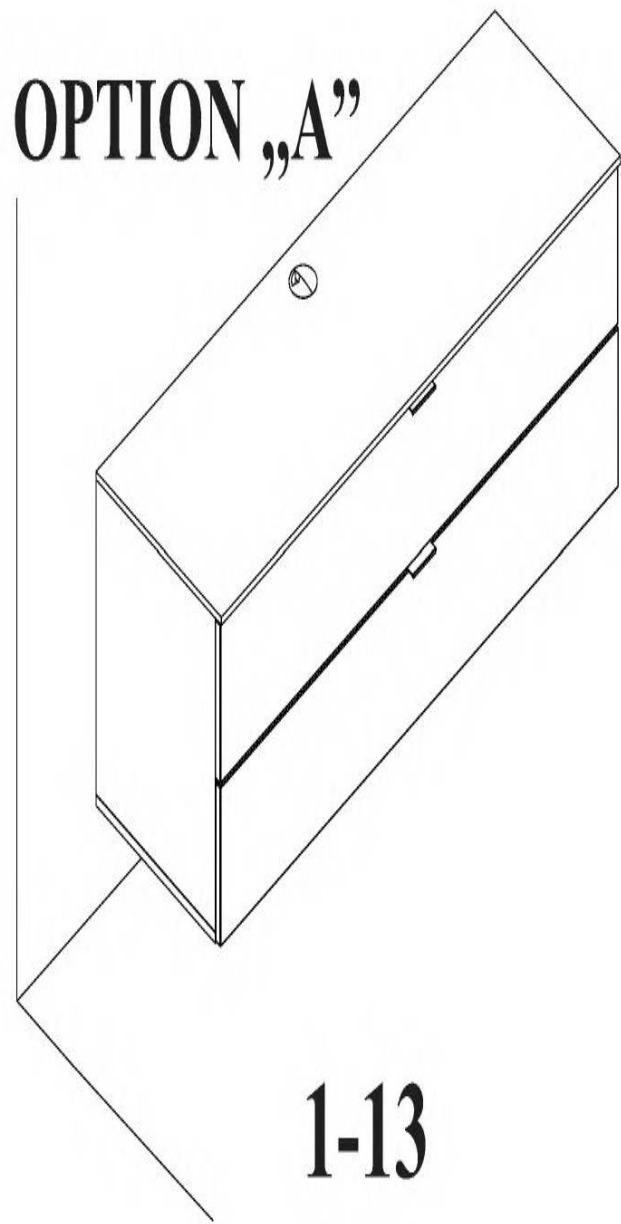

15

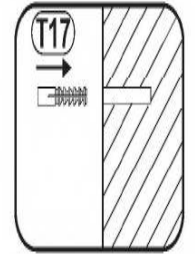
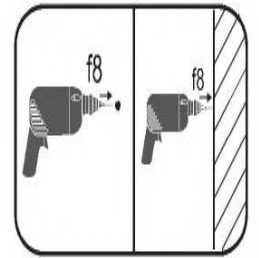
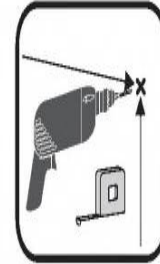
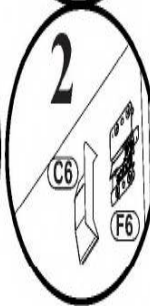
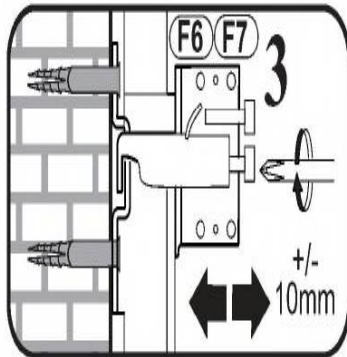
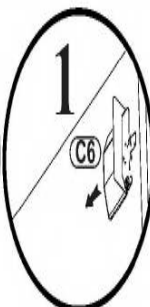
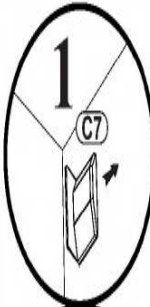
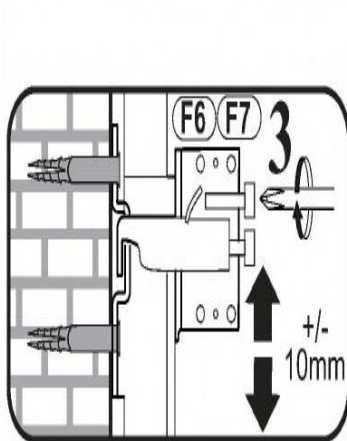
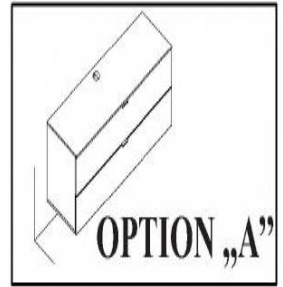
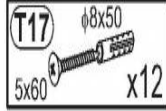

OPTION „A”

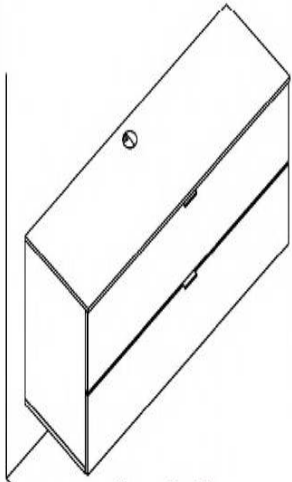

1-13

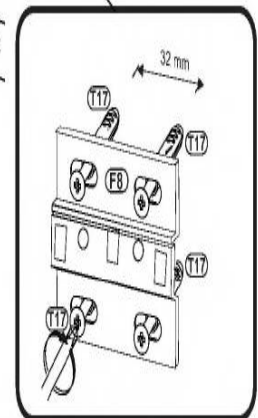
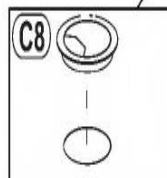
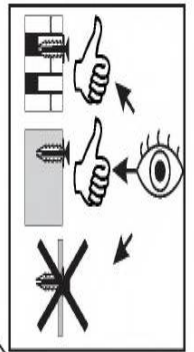
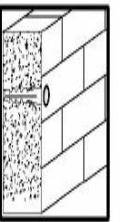
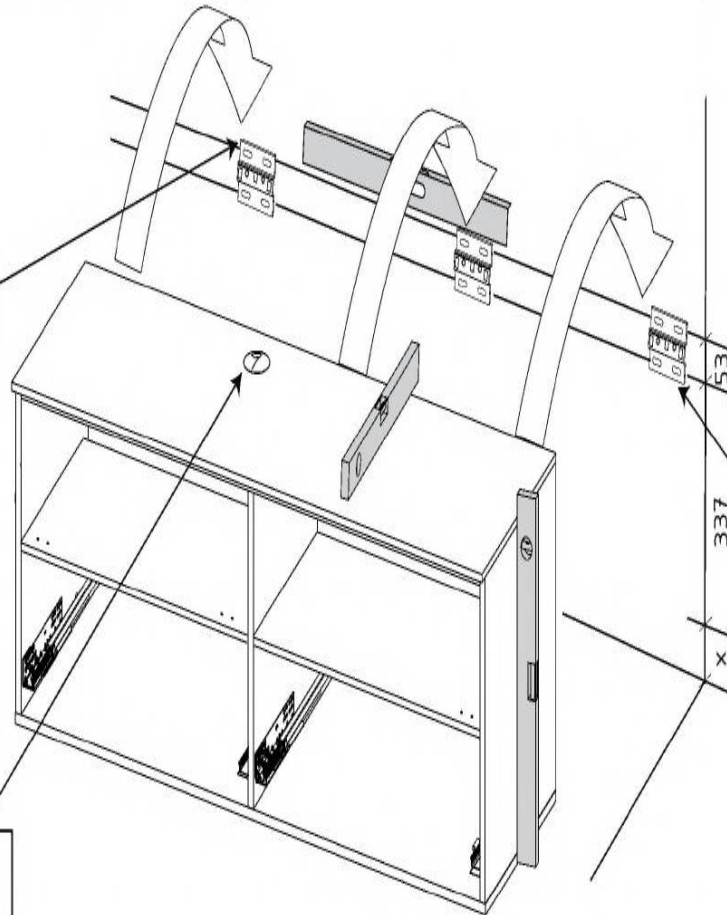
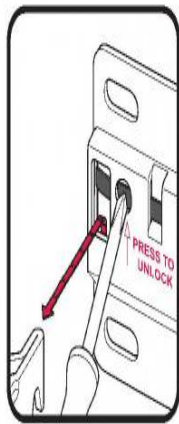
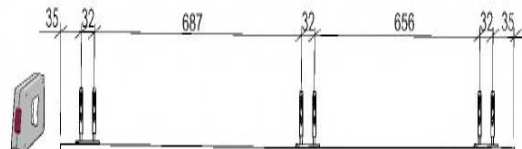

16

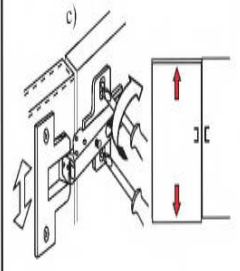
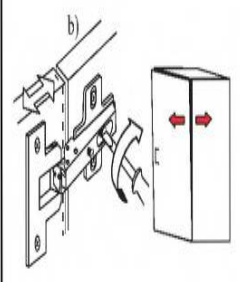
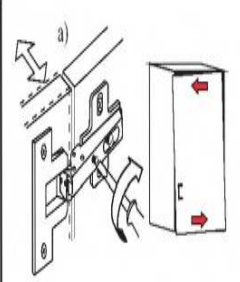
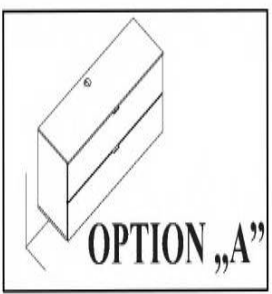
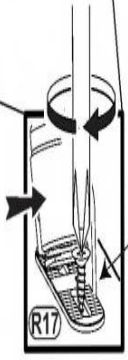
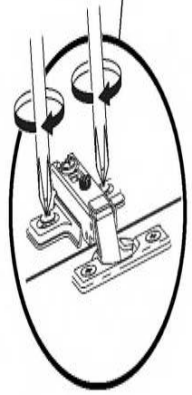
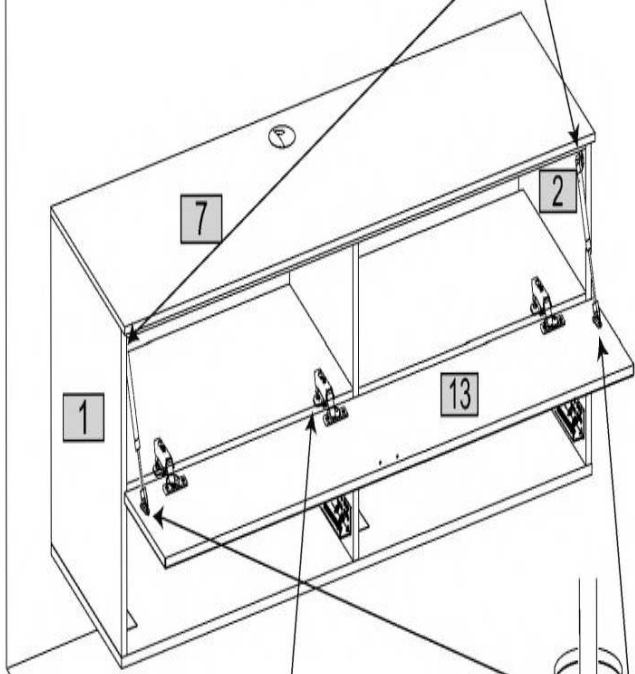
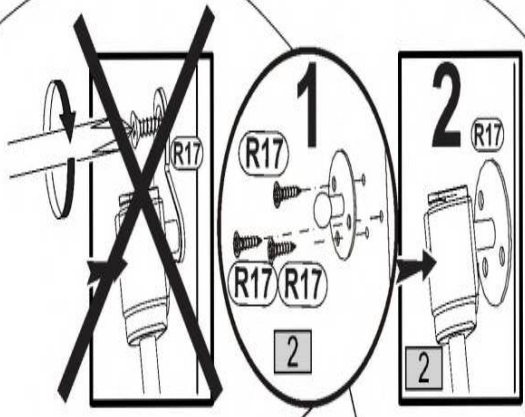
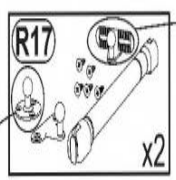

17

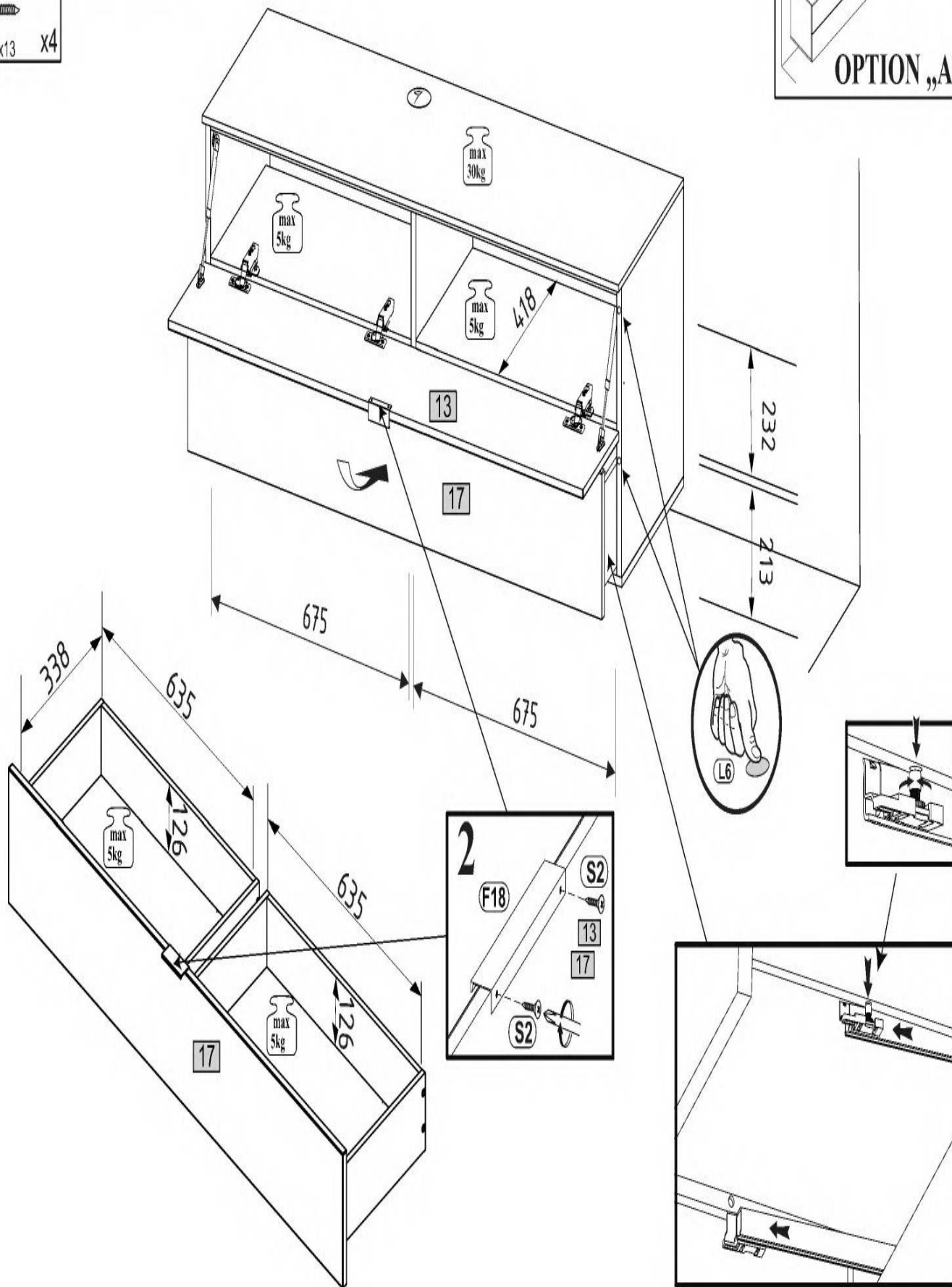
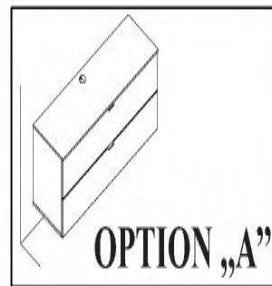
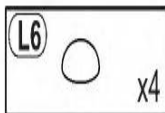
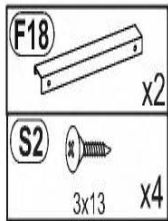

# OPTION „B”

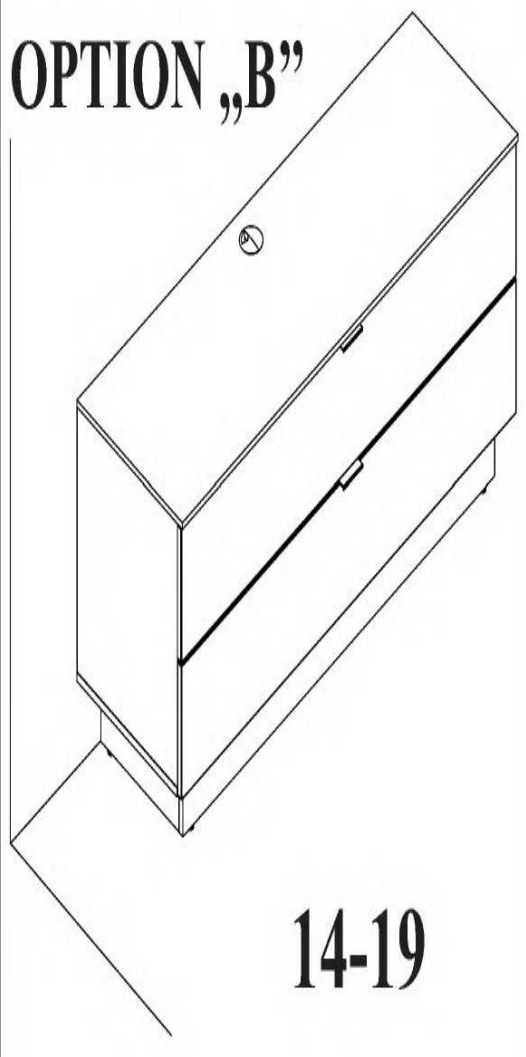

## 14-19

### 18

- F4** x4
- G18** x4
- F7** x1
- L21** x8
- P13** 3,5x13 X16

- B1**  $\phi$  8x28 x4

- T1** x4

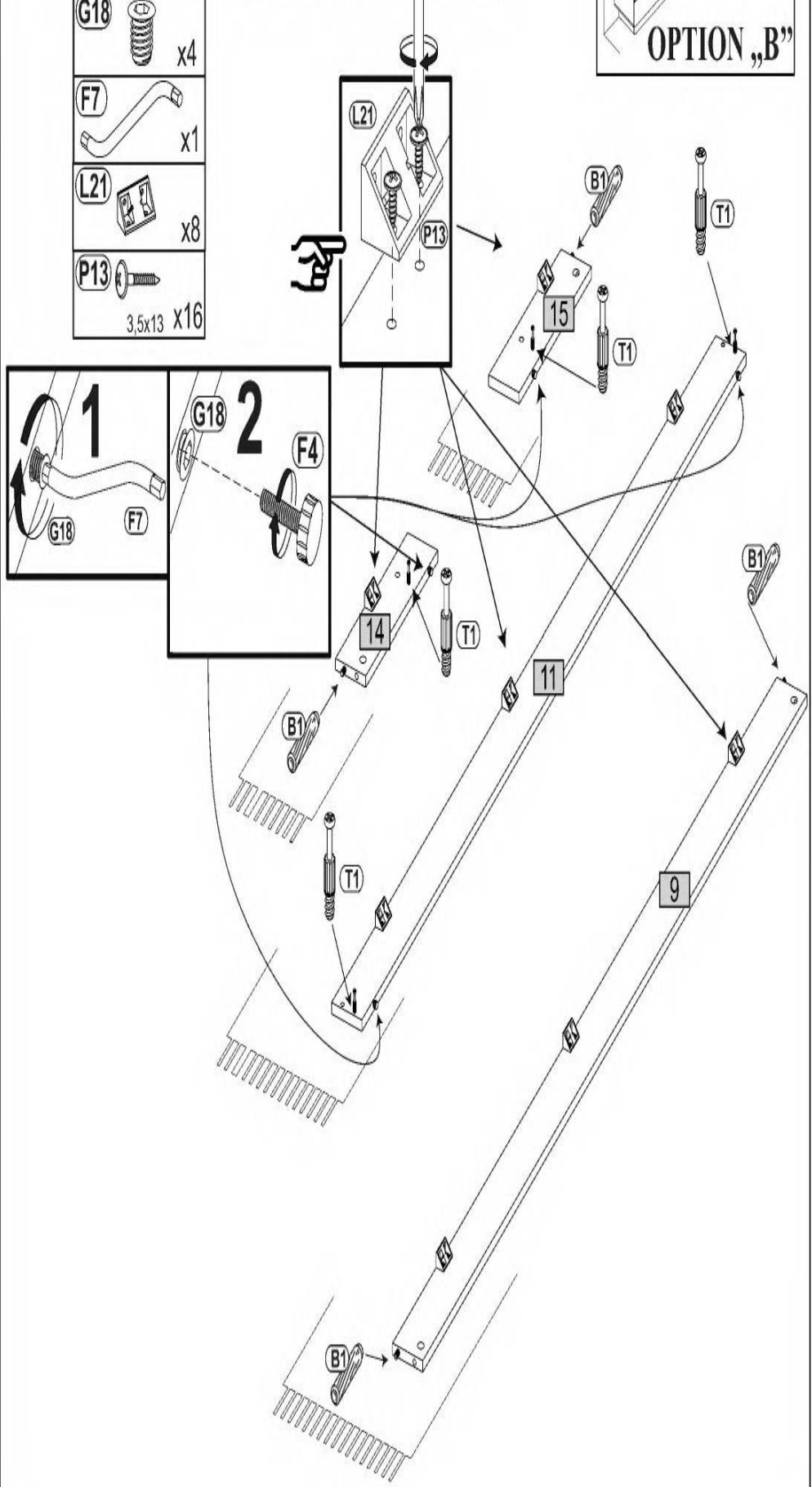
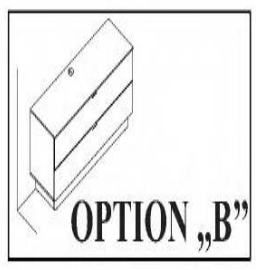

19

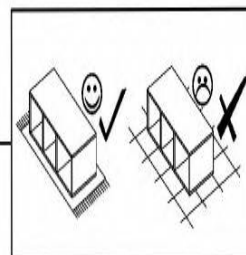
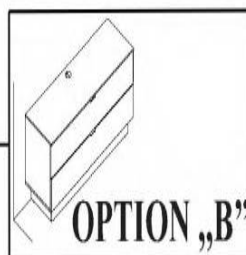
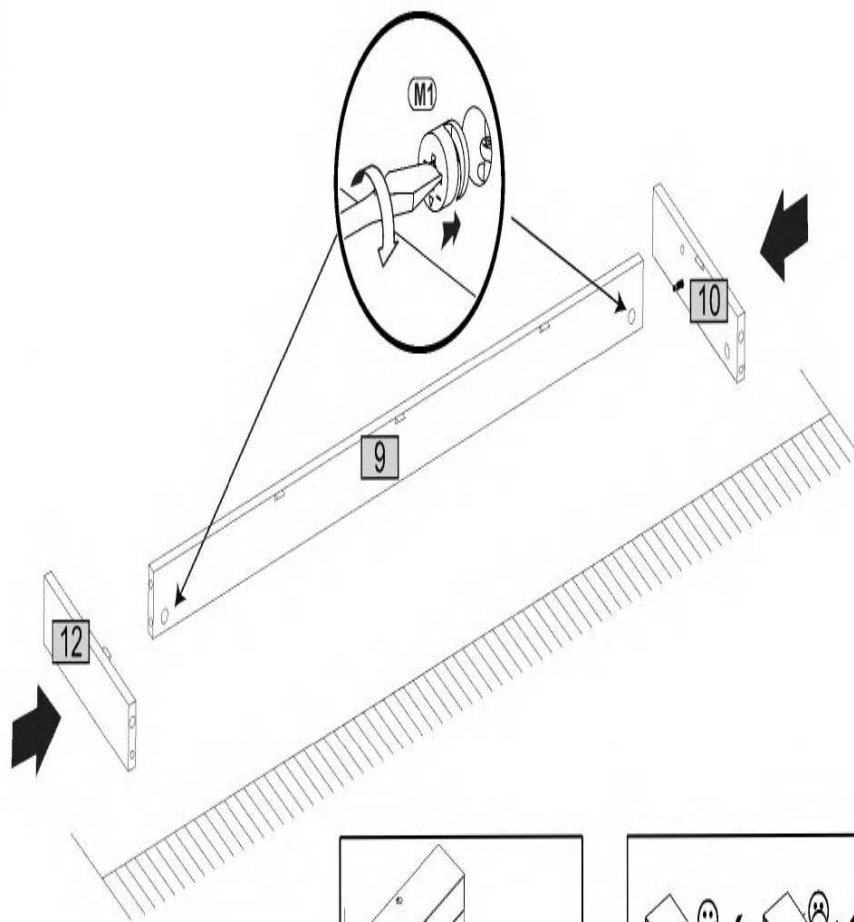

20

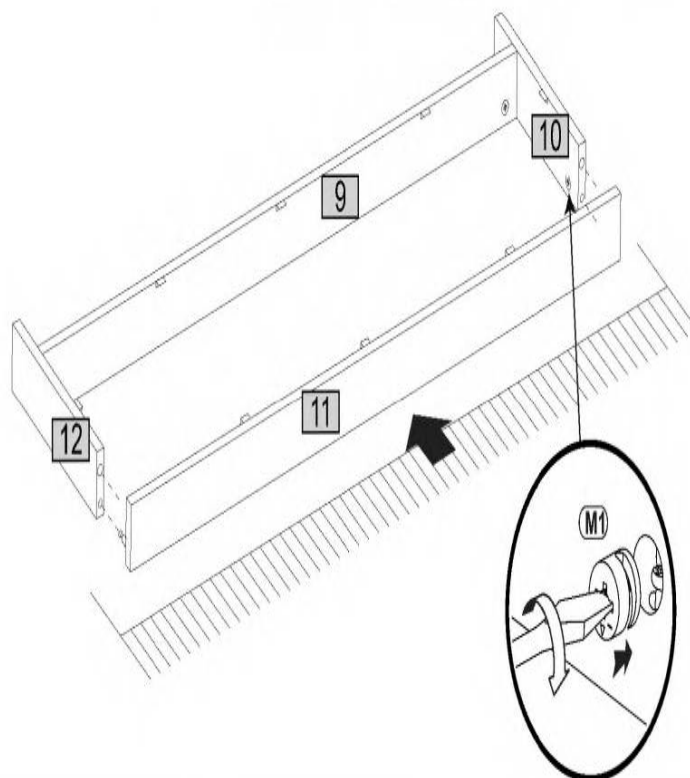

21

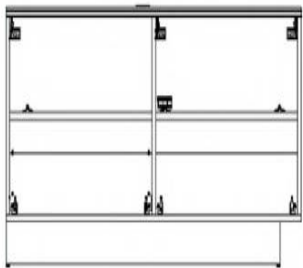
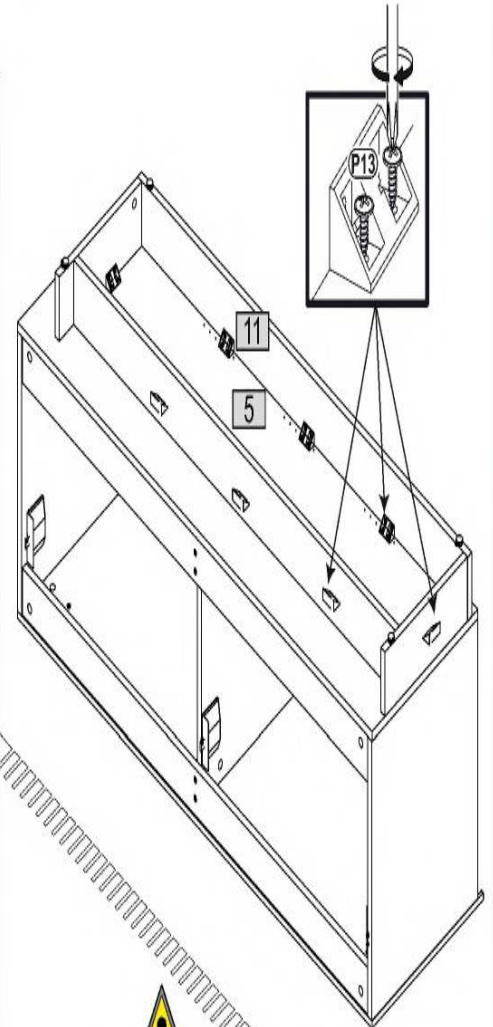
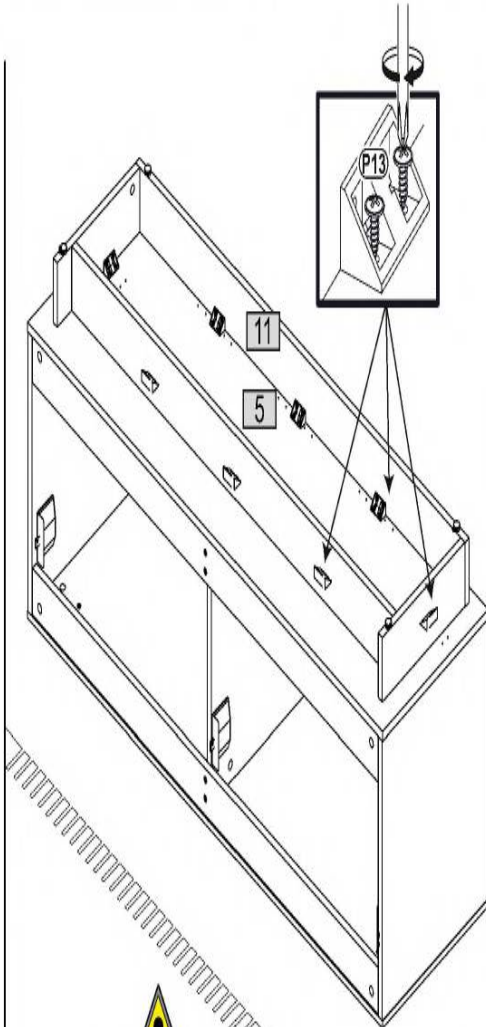
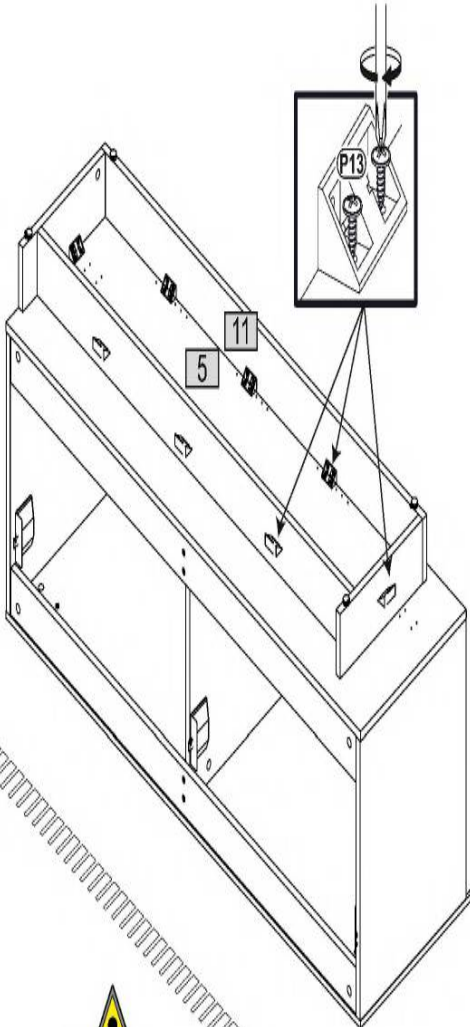
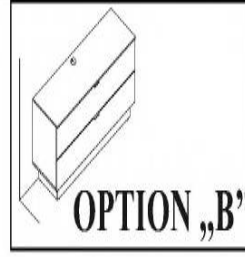
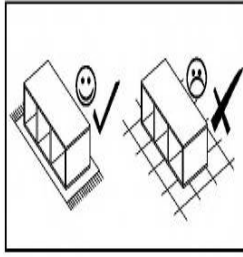
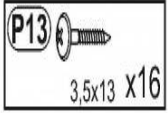

**B1**

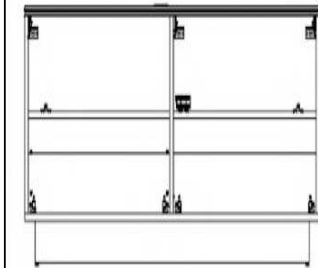

**B2**

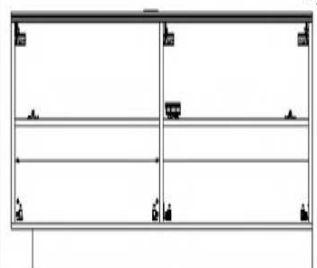
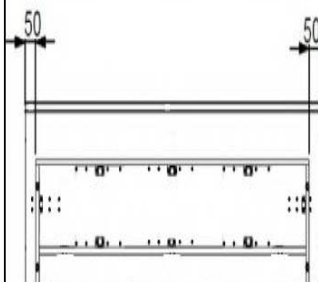

**B3**

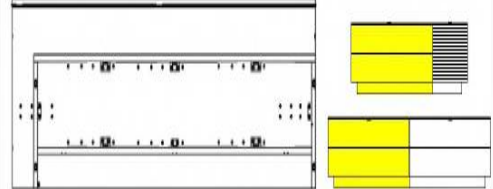

21

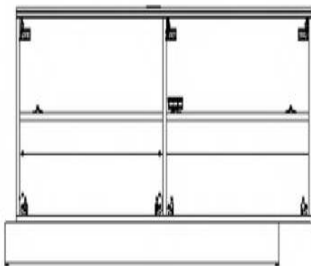
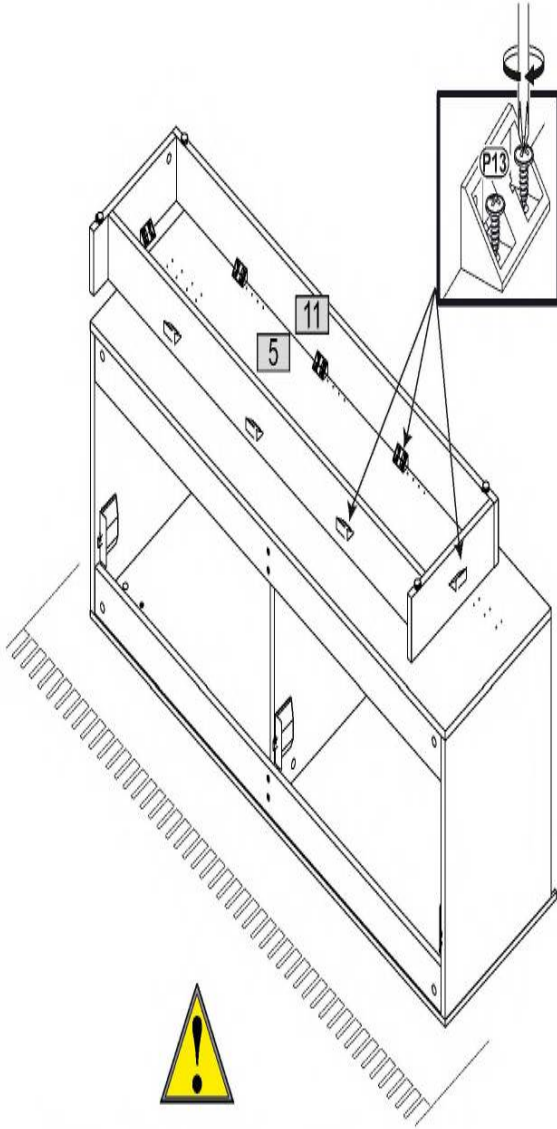
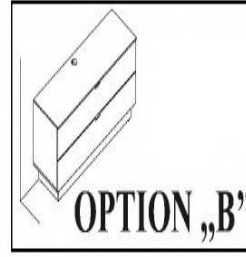
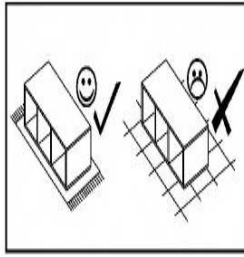
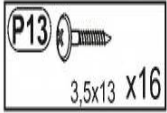

**B4**

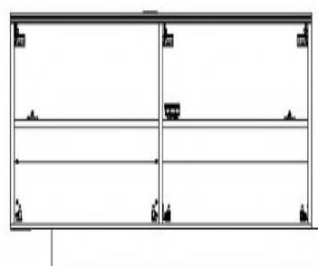
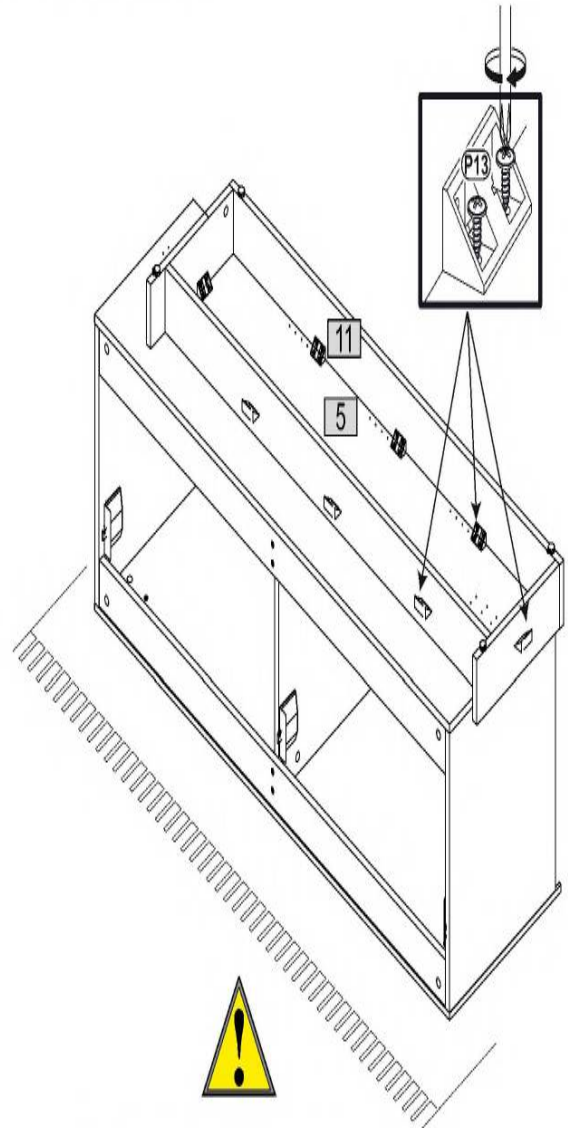
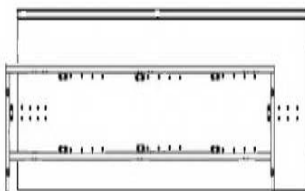

**B5**

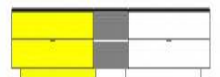
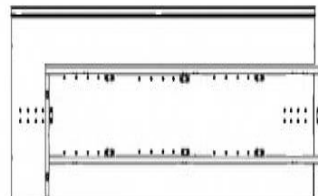

22

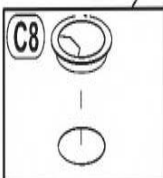
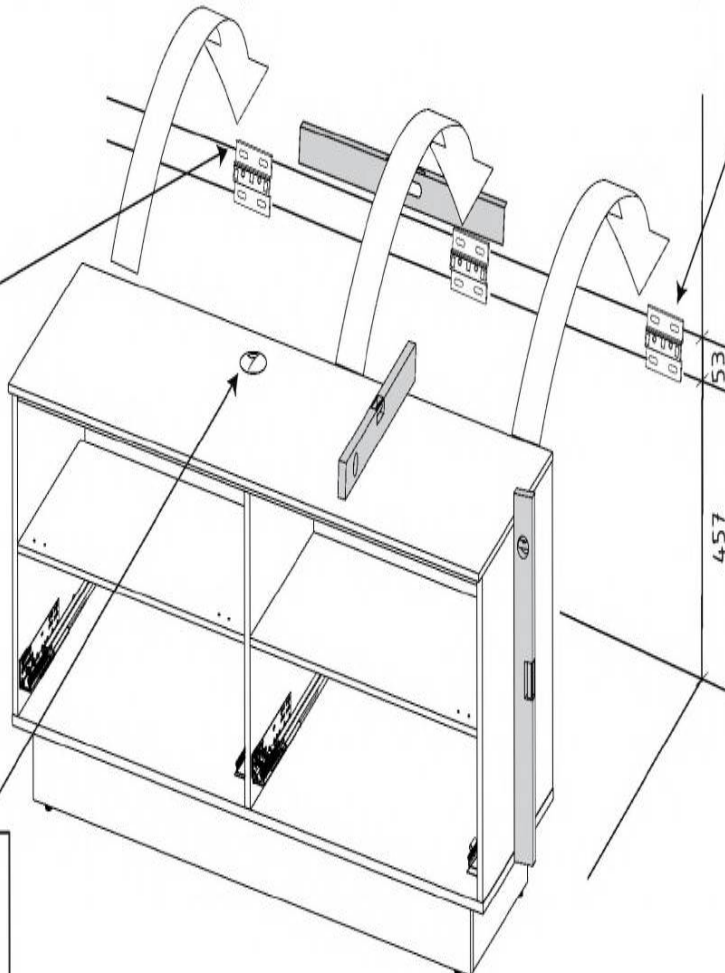
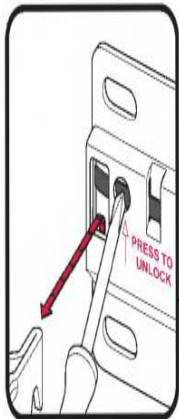
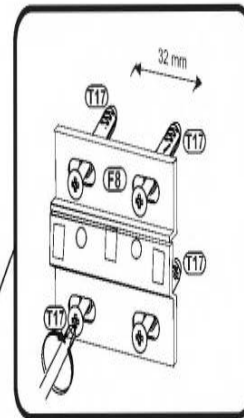
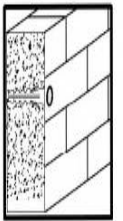
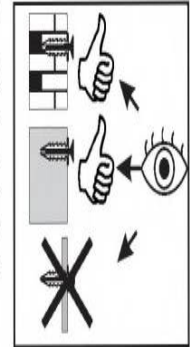
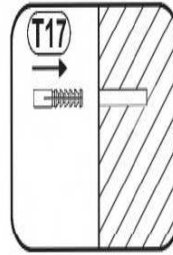
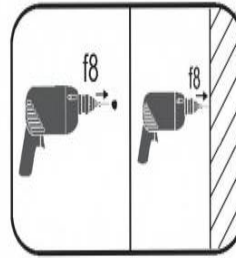
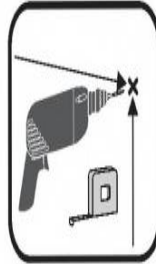
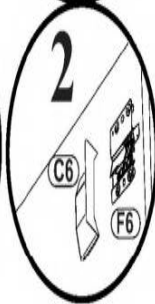
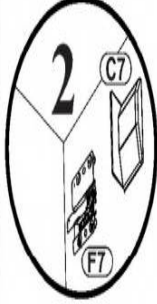
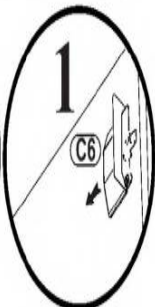
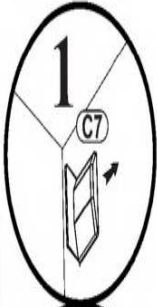
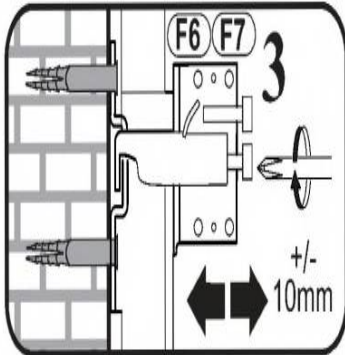
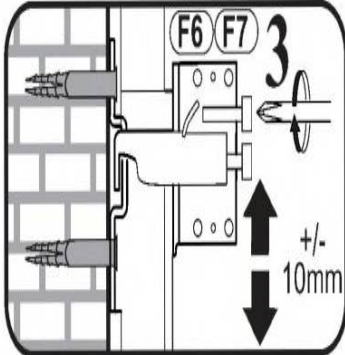
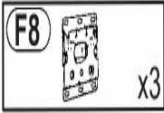
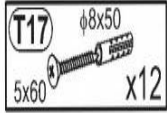

23

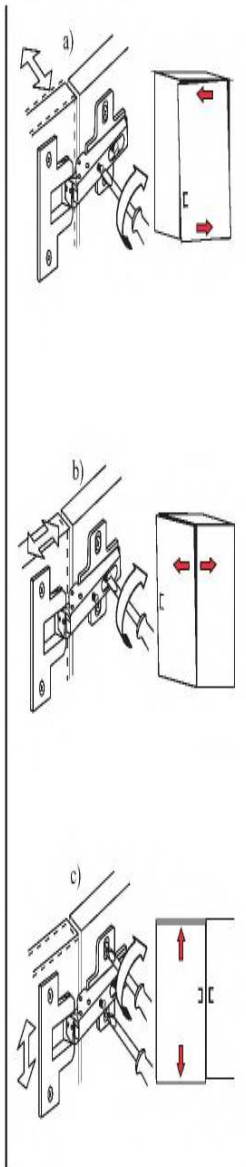
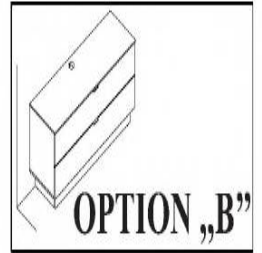
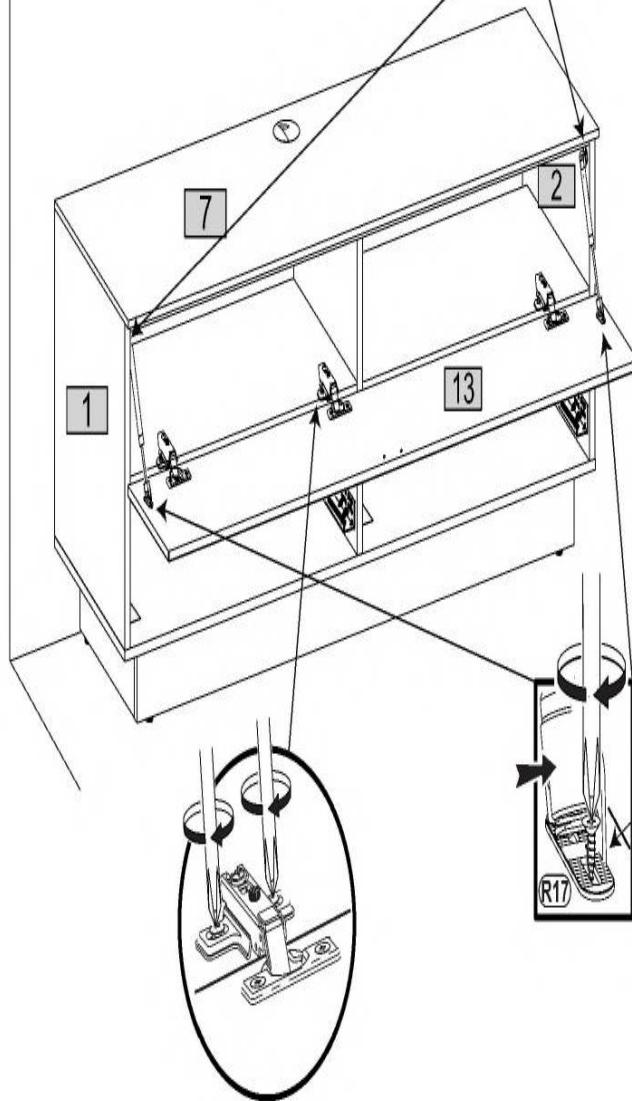
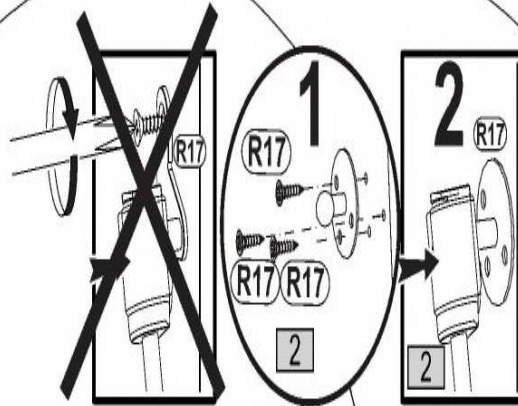
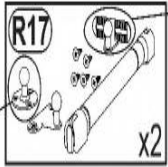



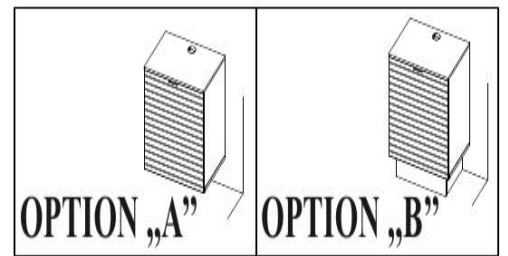
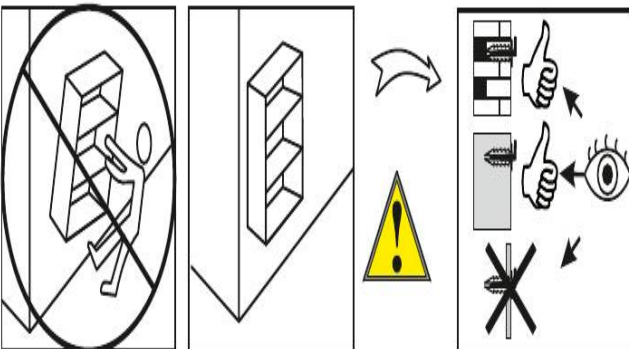
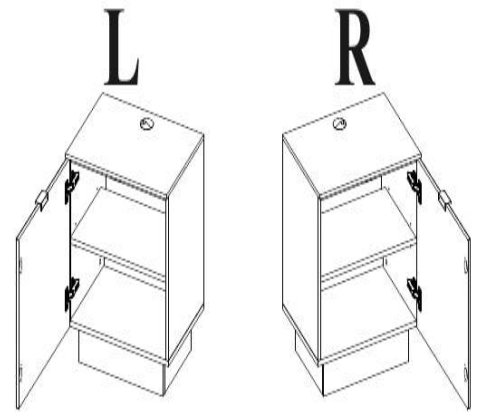
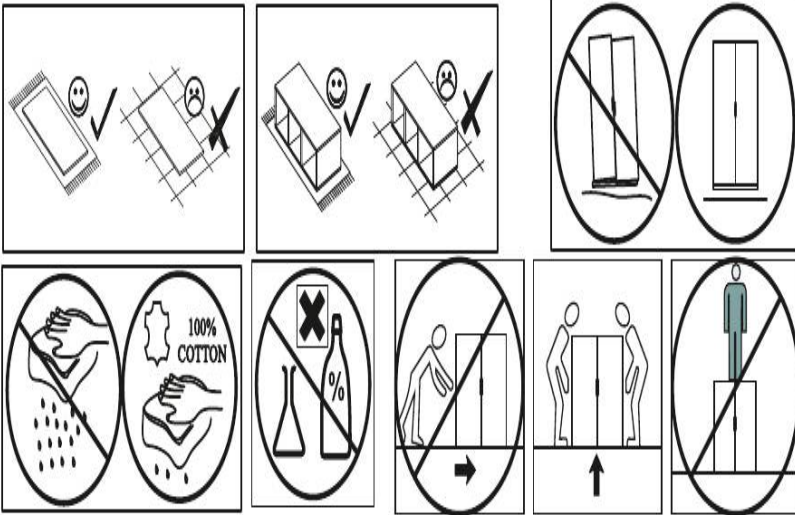
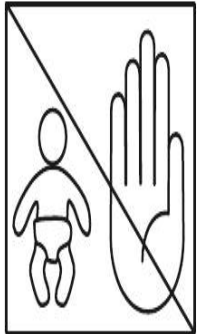
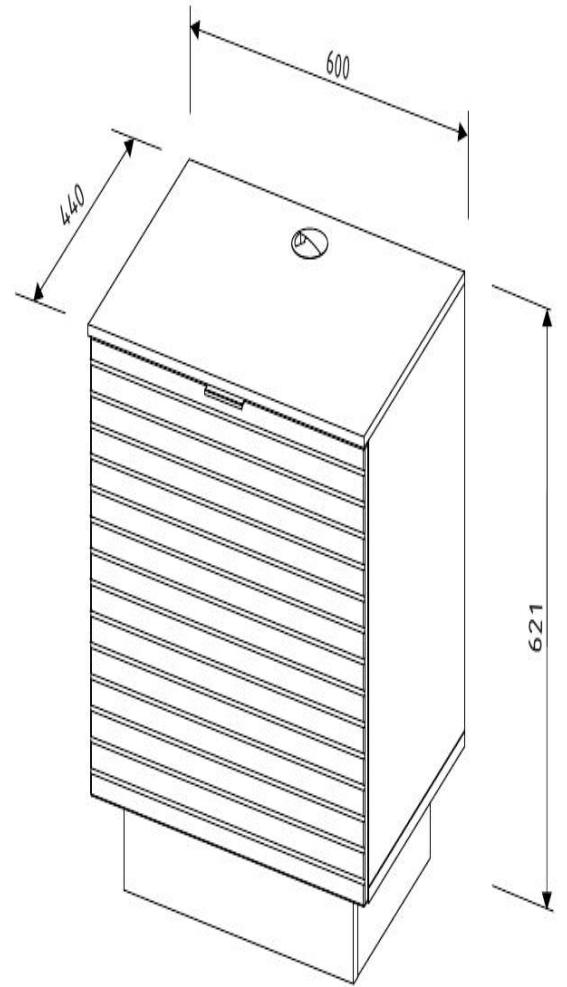
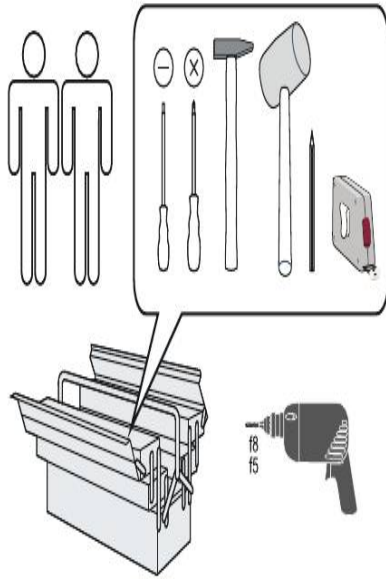

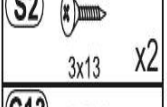
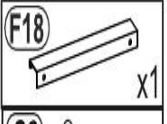
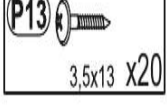
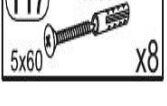
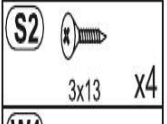
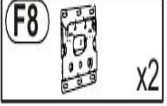
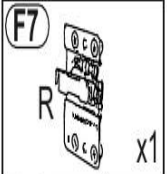
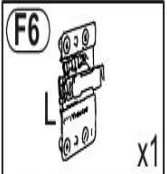
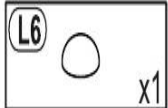
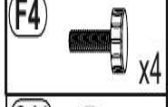
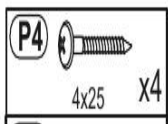
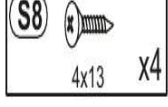
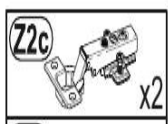
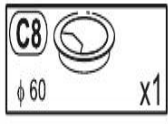
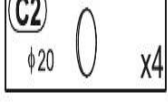
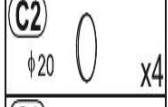
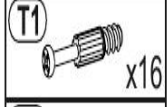
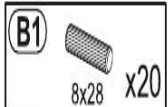

Nr	↙	↘	↗	pcs	☐
1	477	418	16	1	1
2	477	418	16	1	1
3	566	399	16	1	1
4	600	418	16	1	1
5	566	367	16	1	1
6	600	440	12	1	1
7	500	110	16	1	1
8	326	110	16	1	1
9	326	110	16	1	1
10	466	110	16	1	1
11	566	80	16	2	1
12	596	488	16	1	1

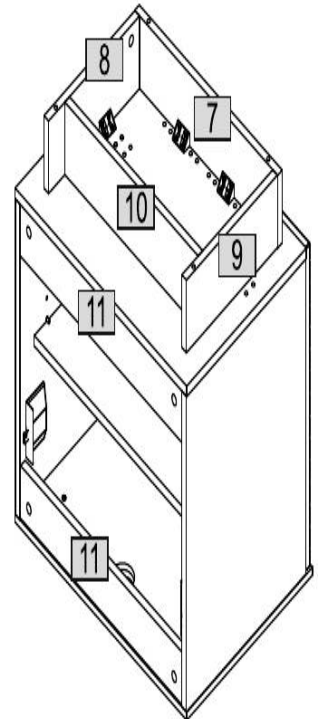
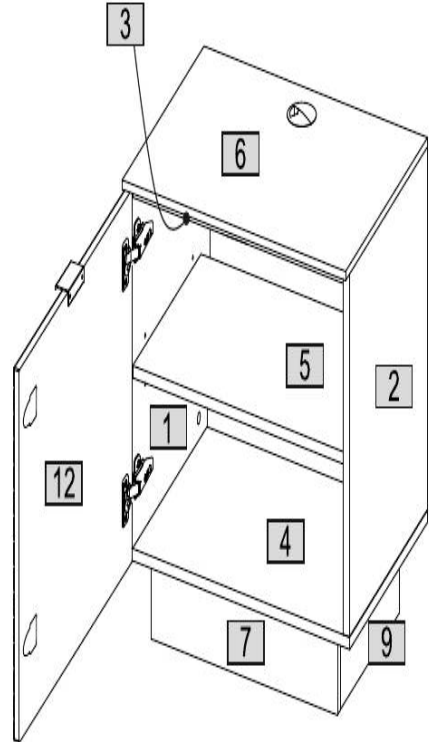

0 10 20 30 40 50 60 70 80 90 100 110 120 130 140 150 160 170 180 190 200



1

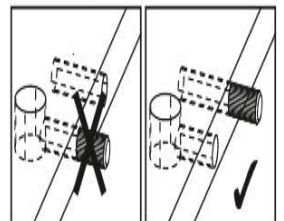
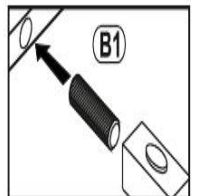
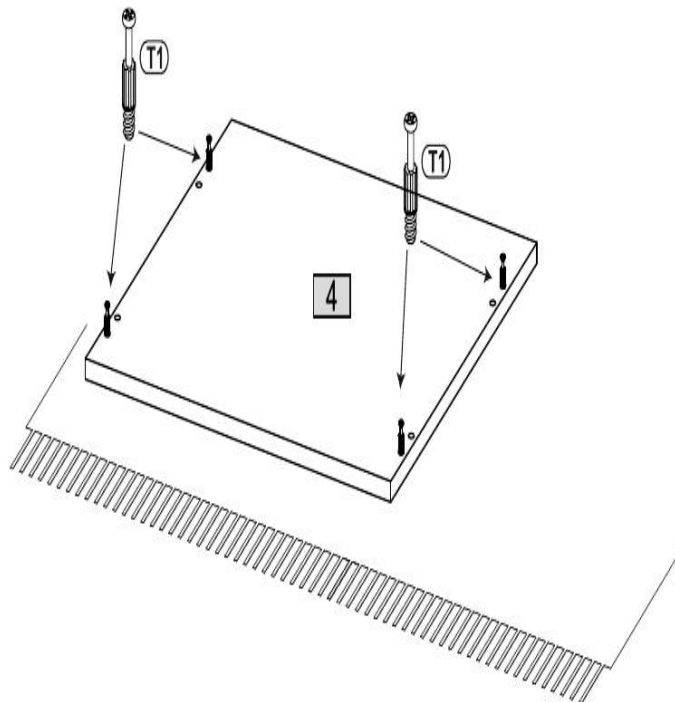
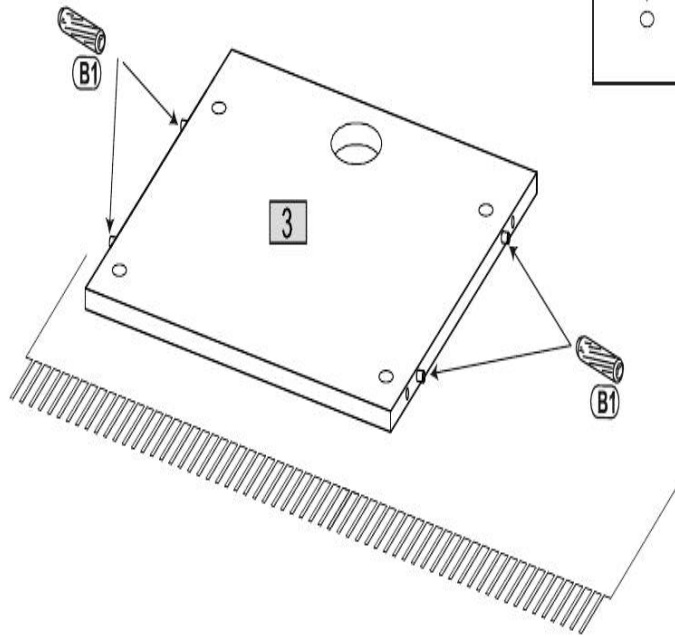
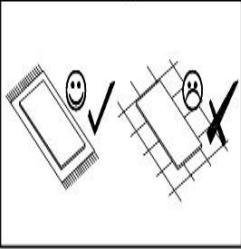
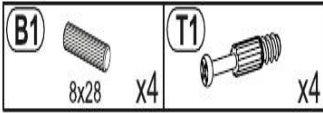

2

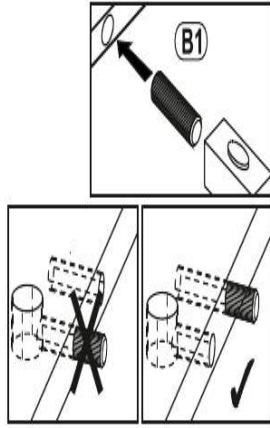
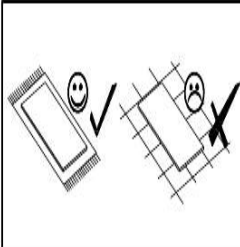
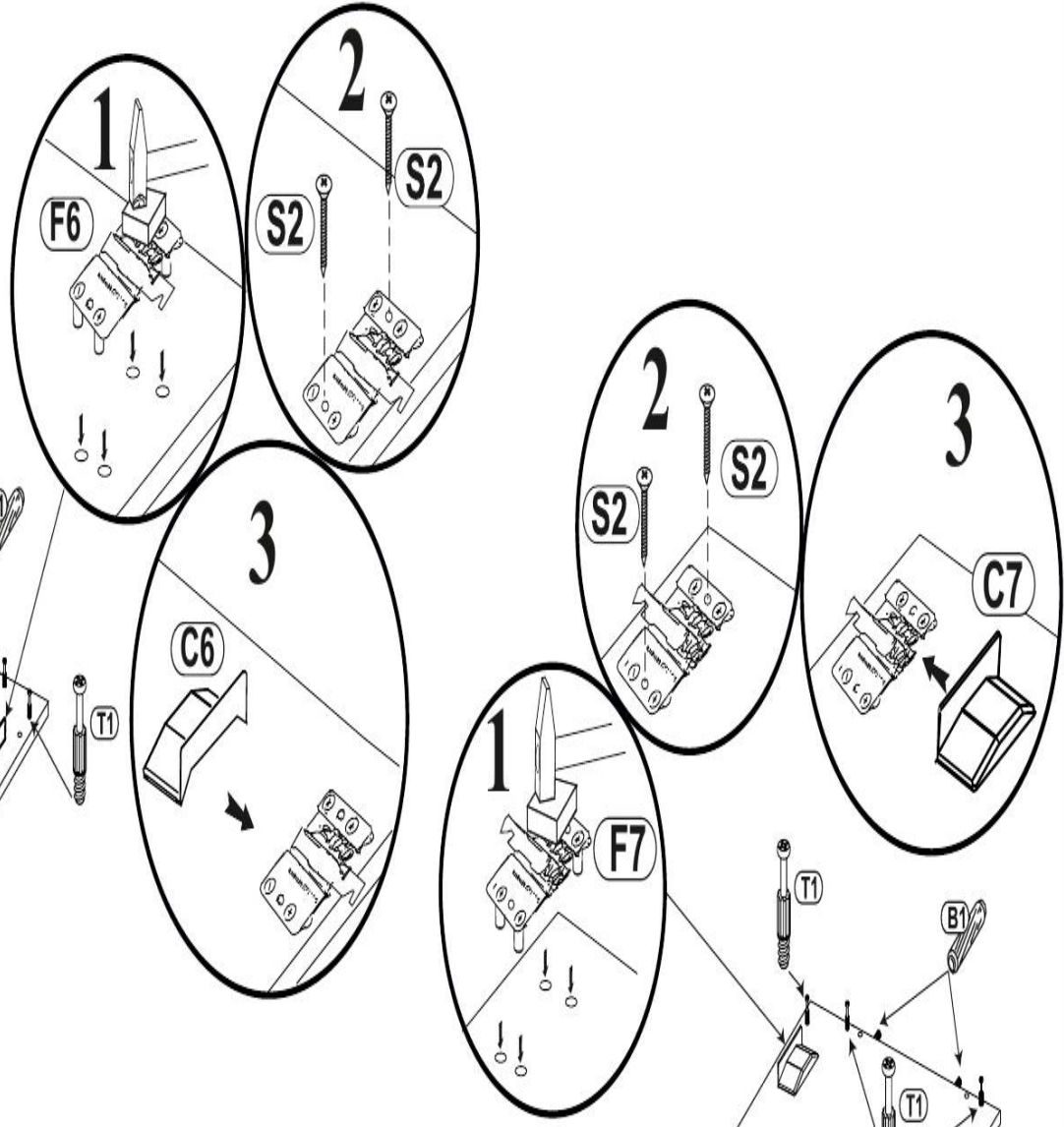
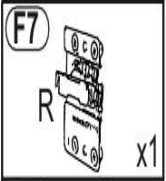
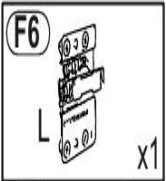
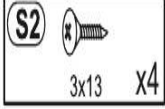
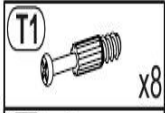
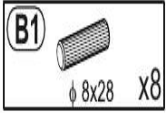

3

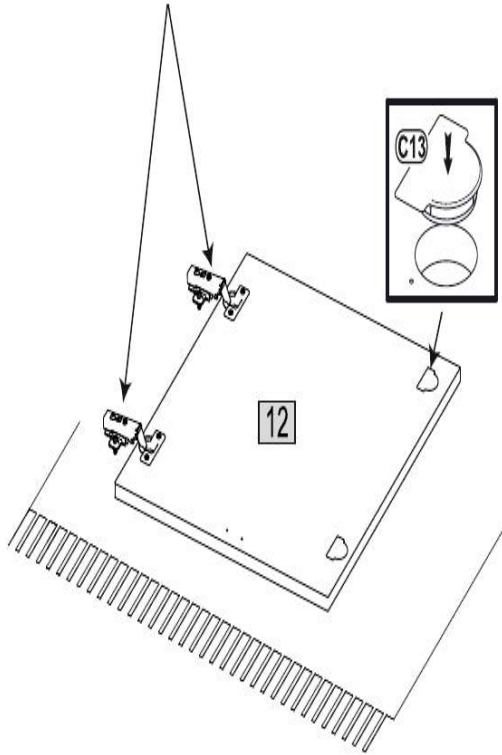
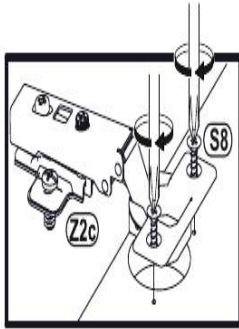
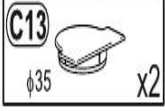
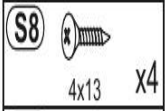

4

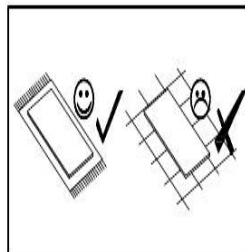
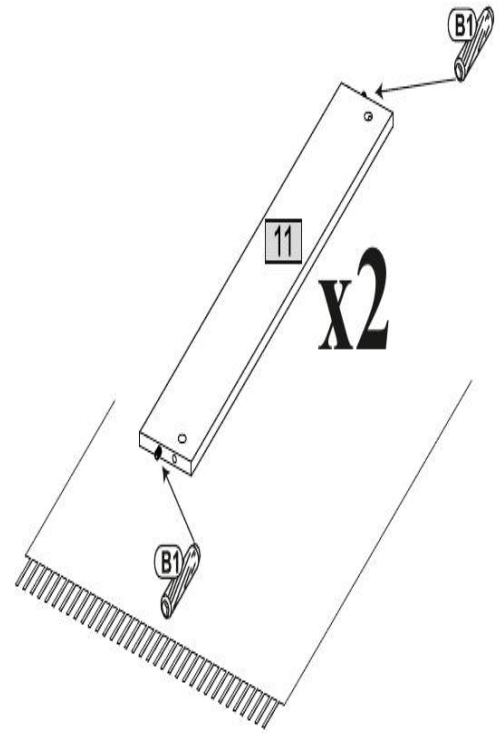
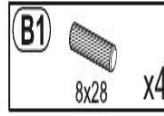

5

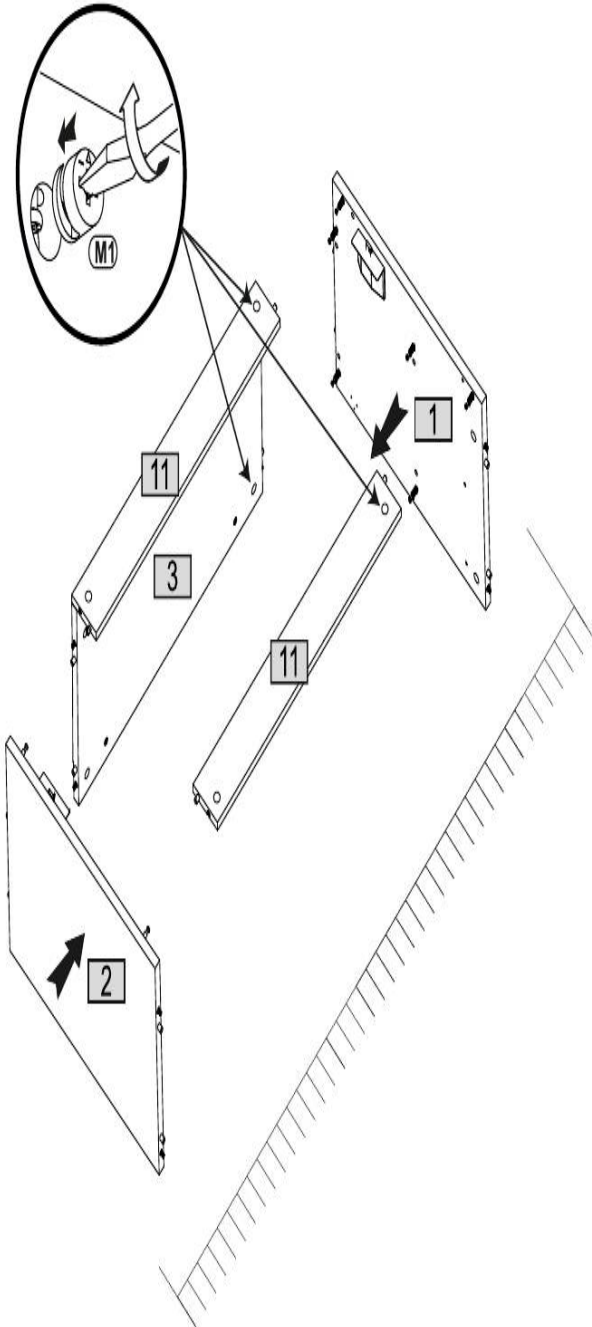

6

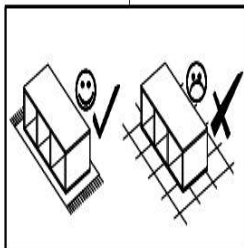
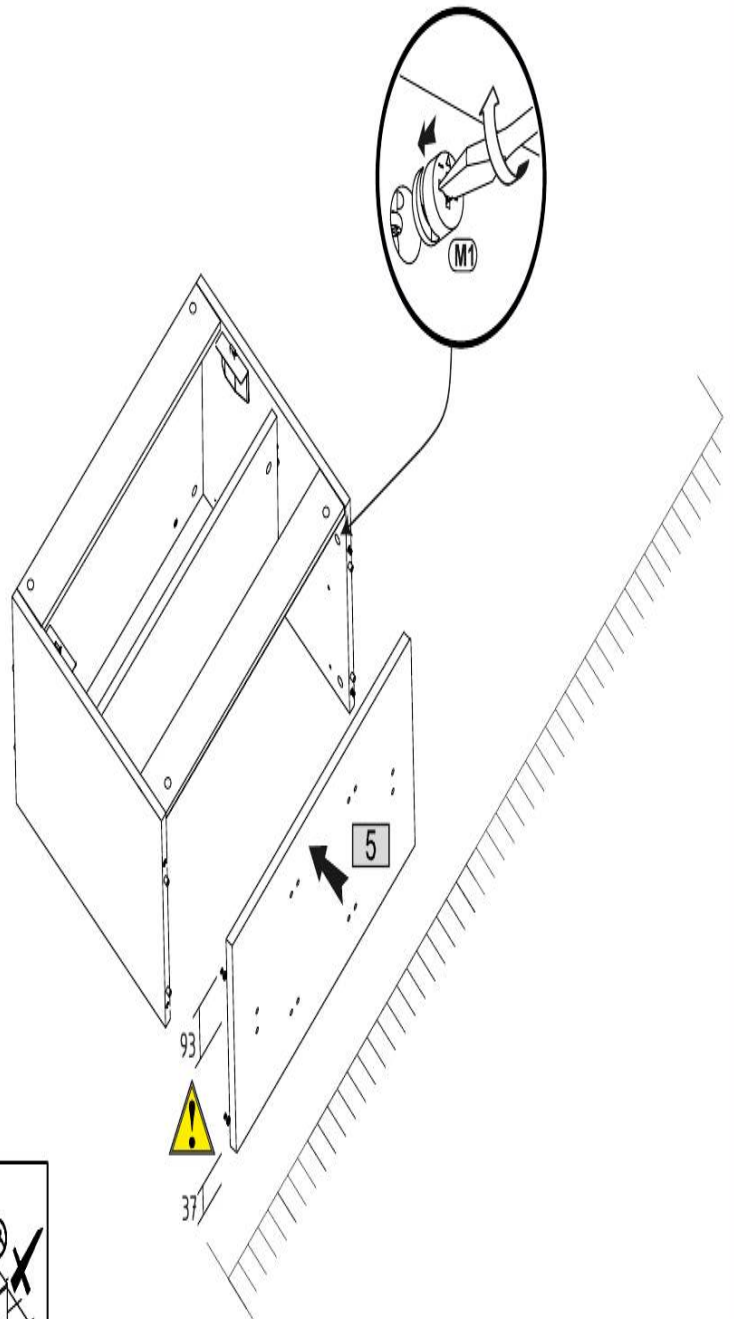

7 **P4** 4x25 X4

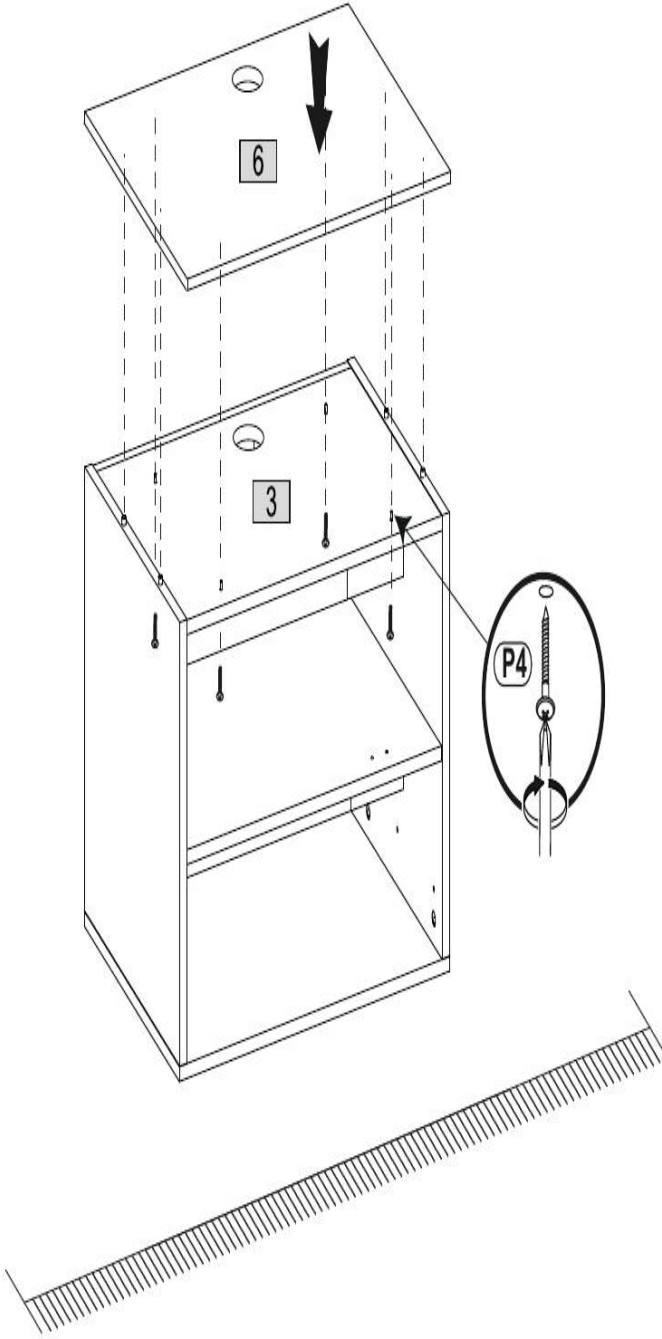

# OPTION „A”

1-9

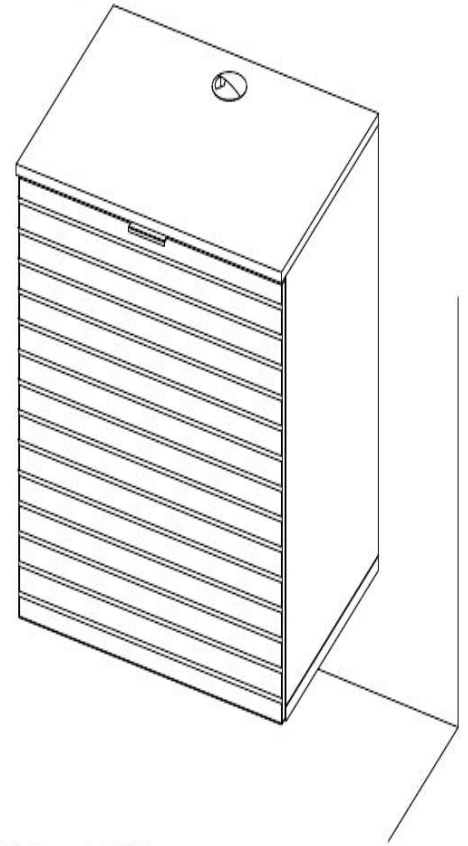

# OPTION „B”

10-15

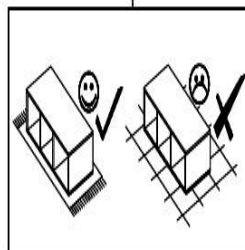
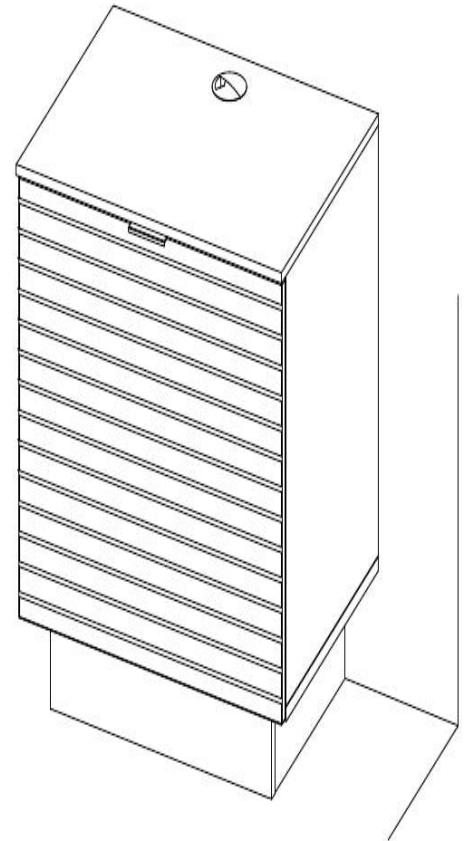

8

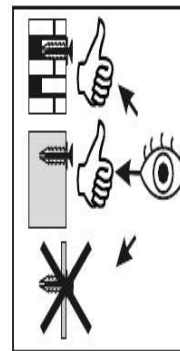
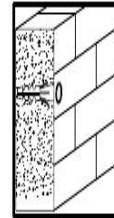
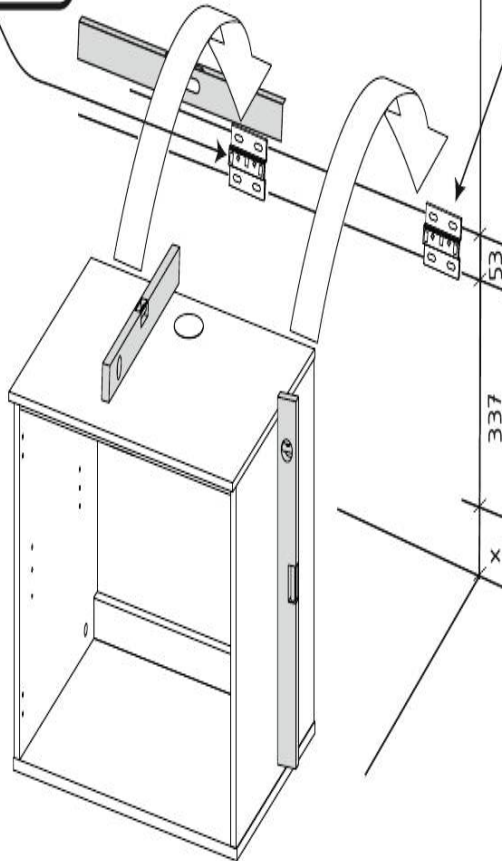
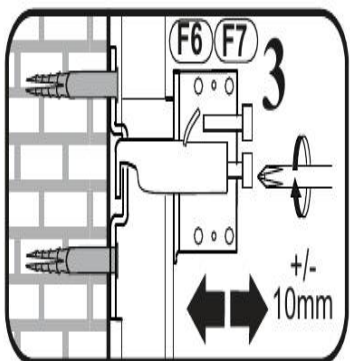
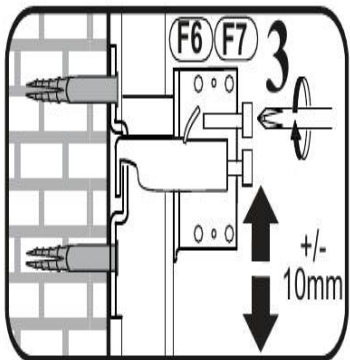
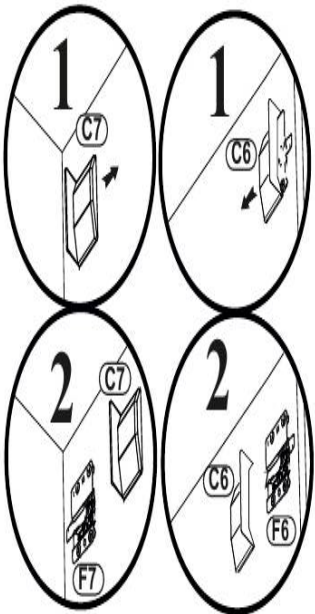
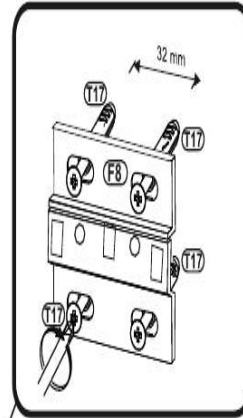
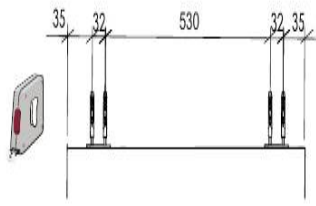
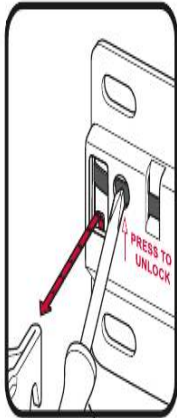
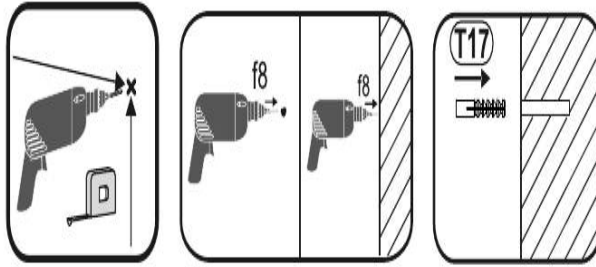
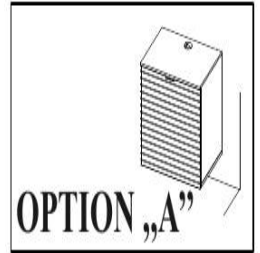
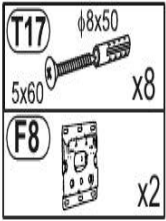

9

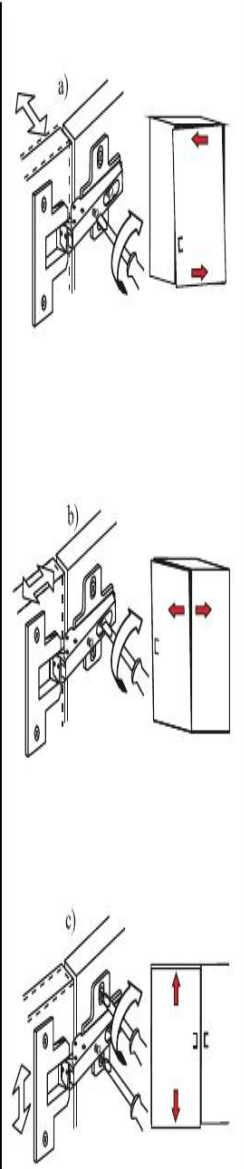
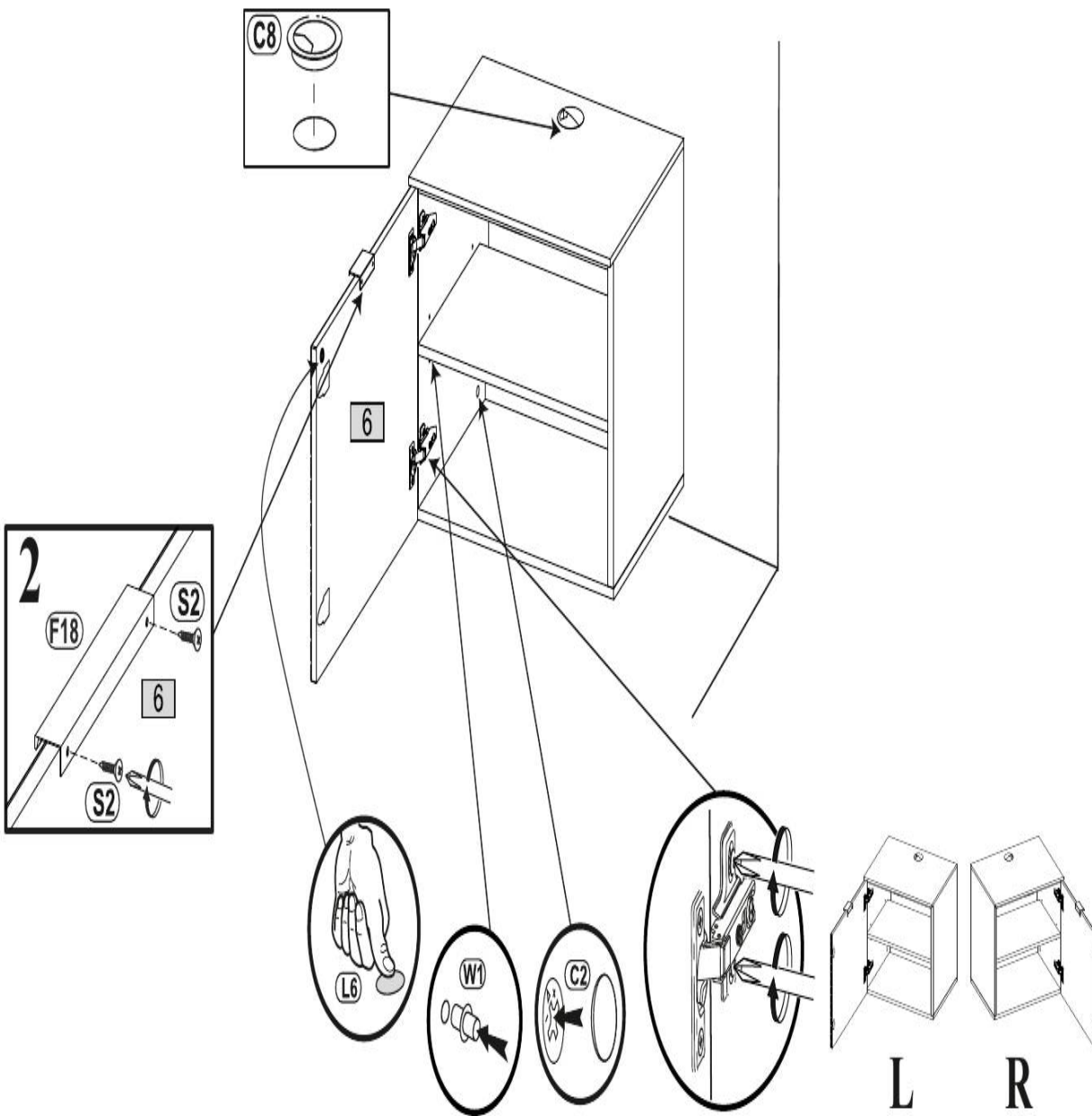
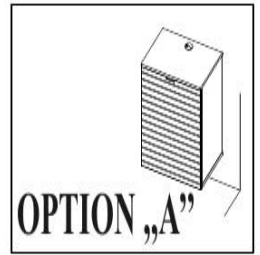
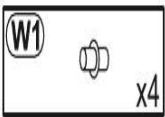
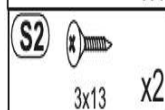
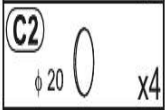
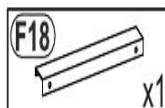
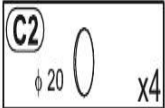

# OPTION „B”

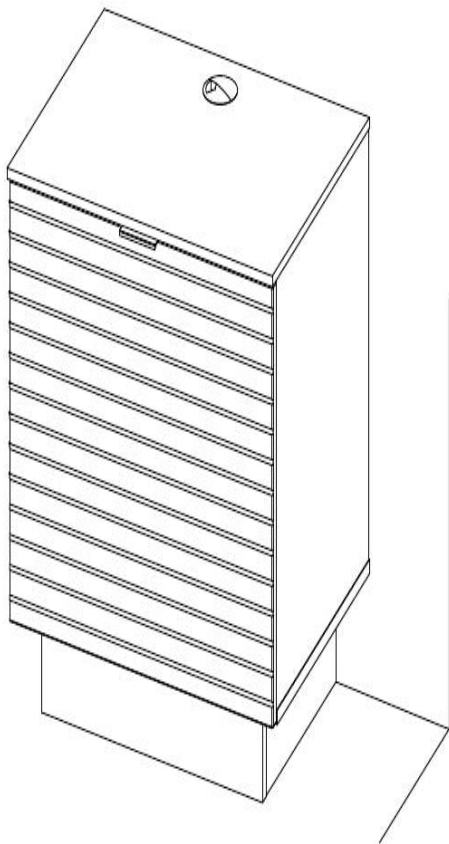

10-15

10

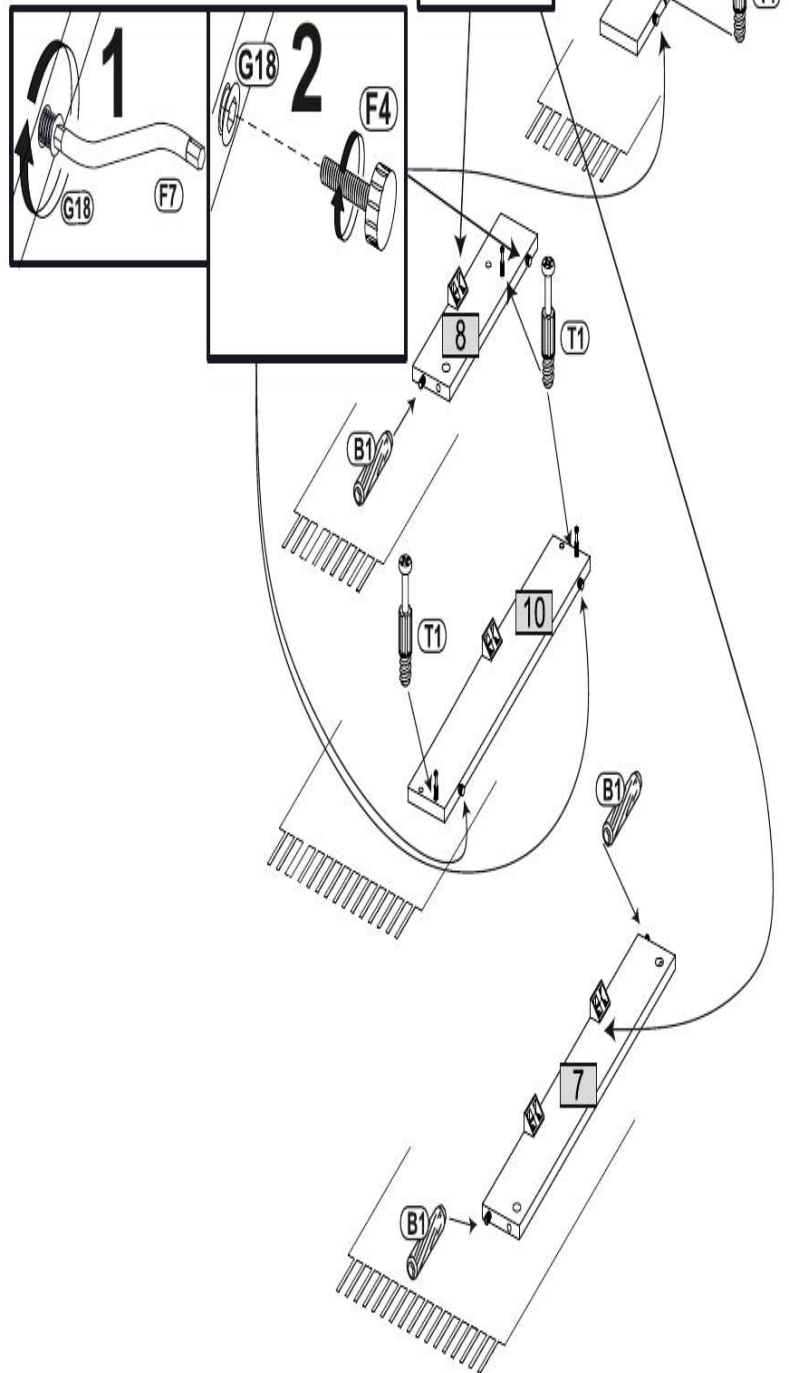
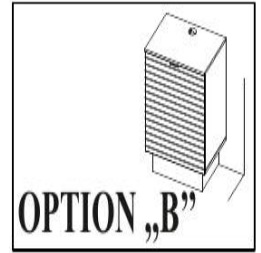
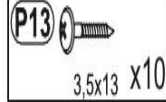
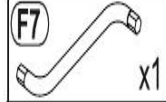
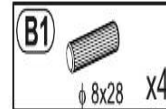
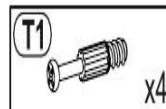

11

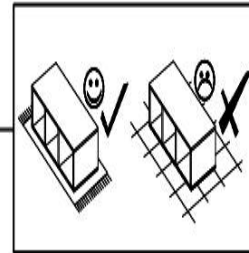
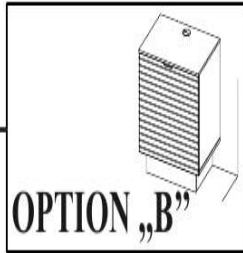
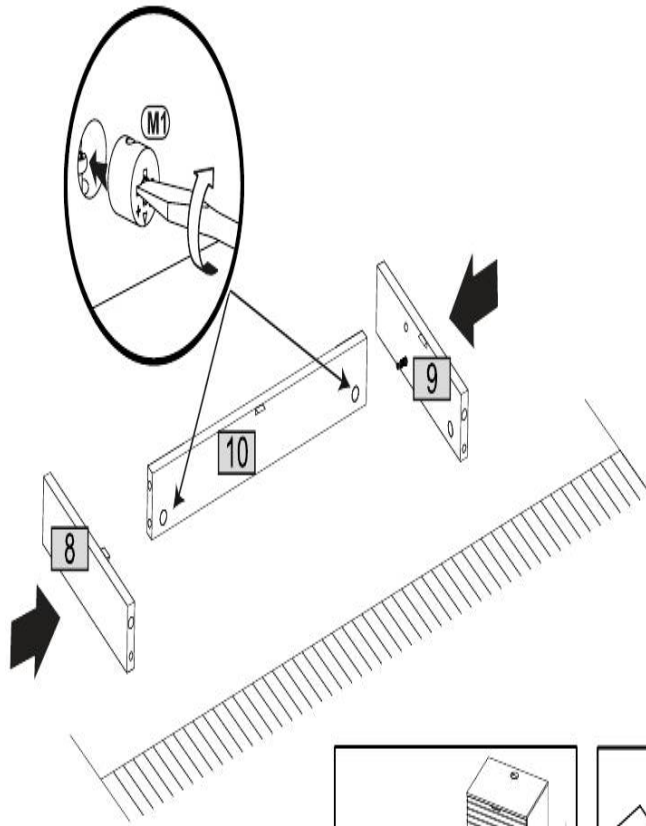

12

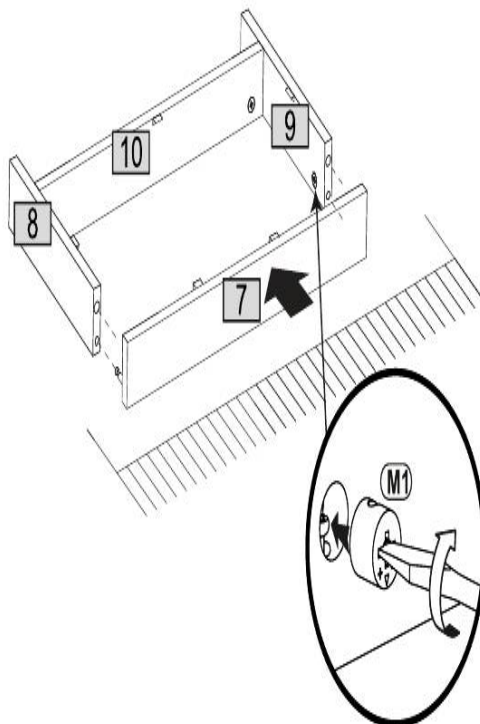

13

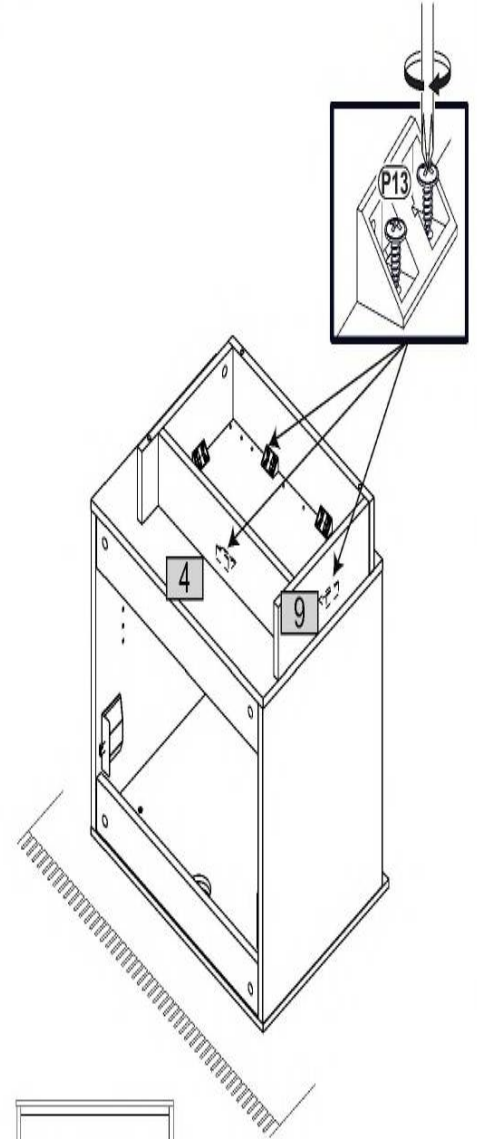
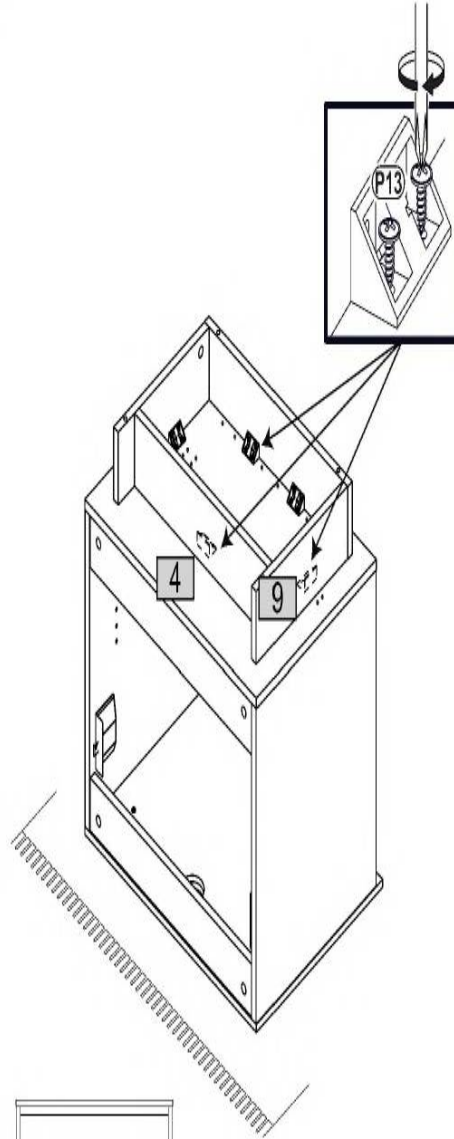
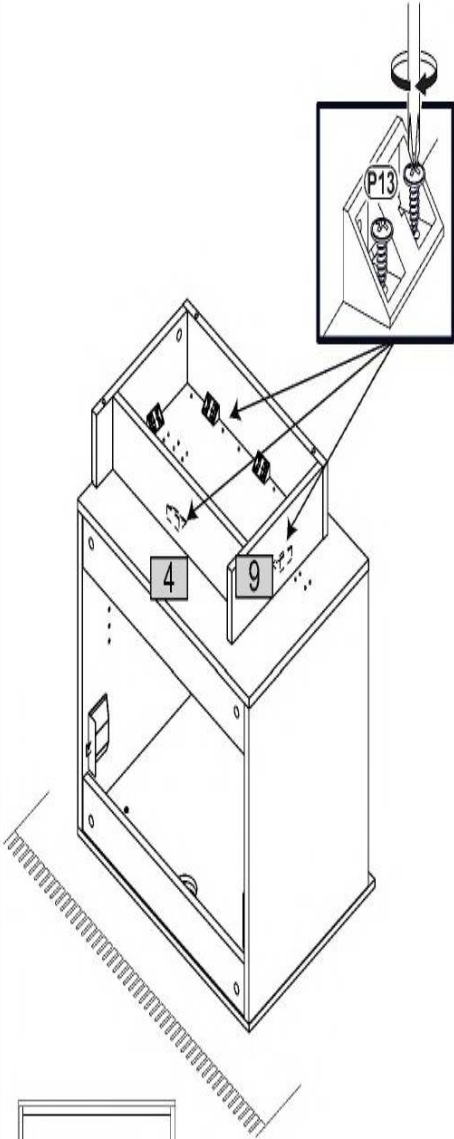
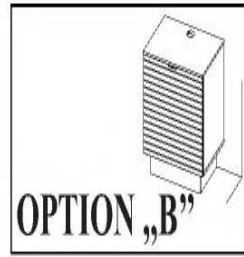
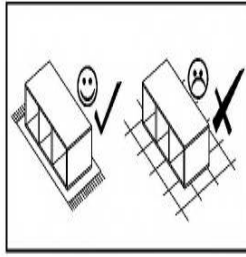
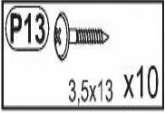

 **B1**

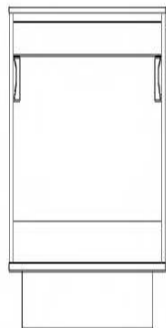
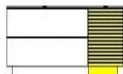
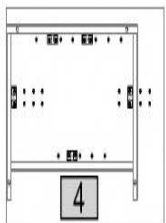

 **B2**

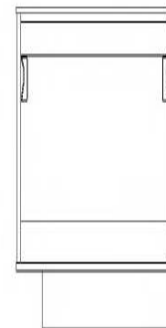
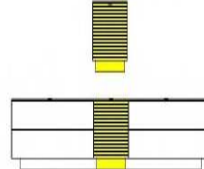
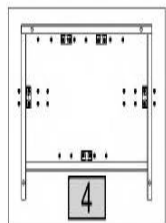

 **B3**

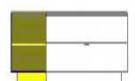
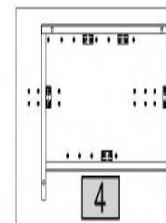

13

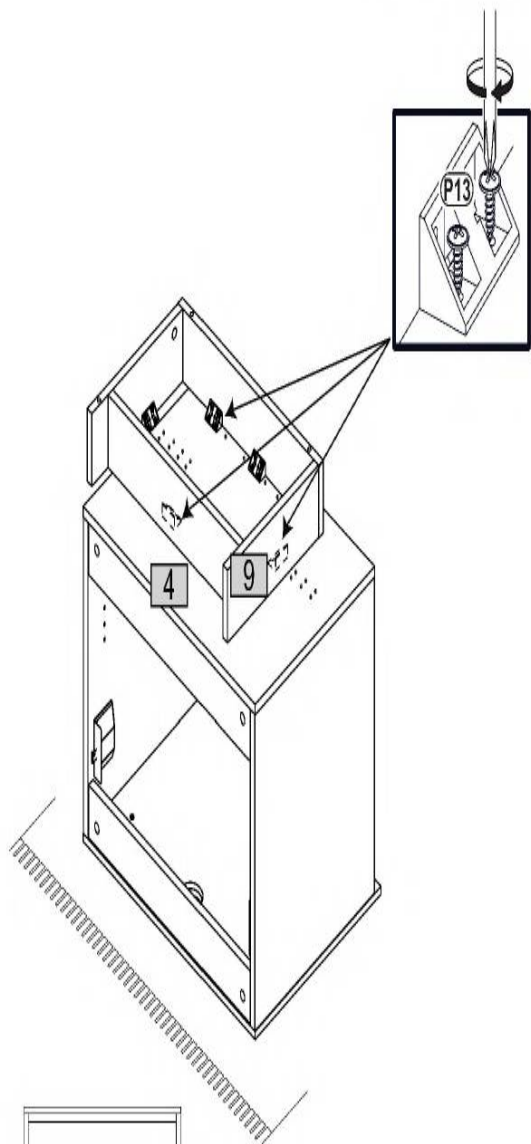
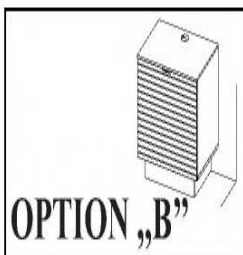
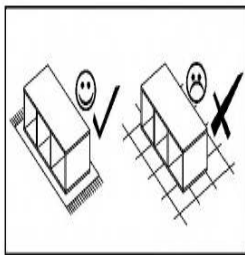
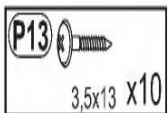

**B4**

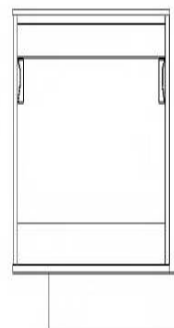
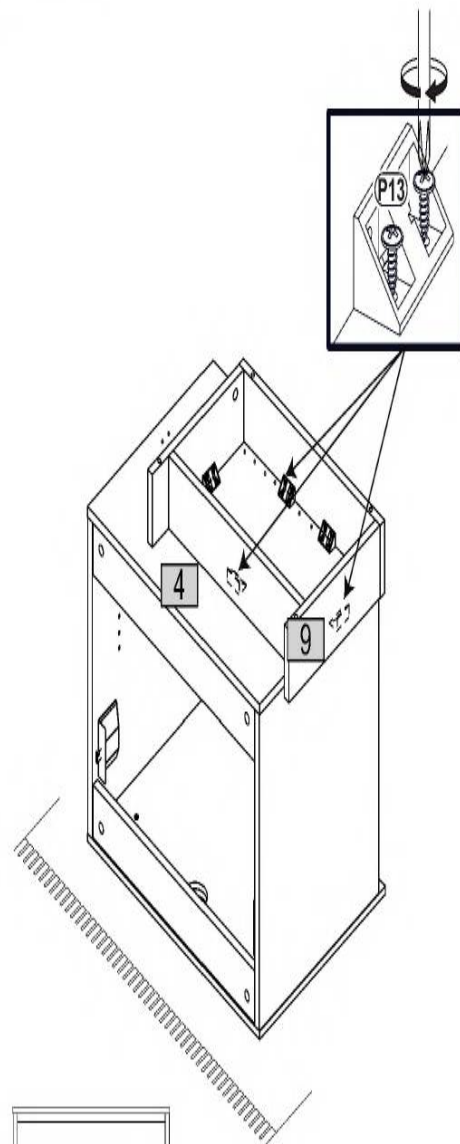
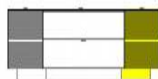
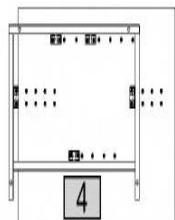

**B5**

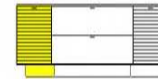
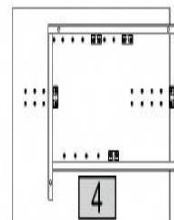

14

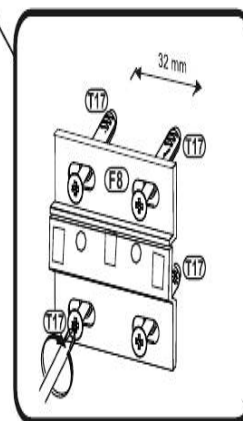
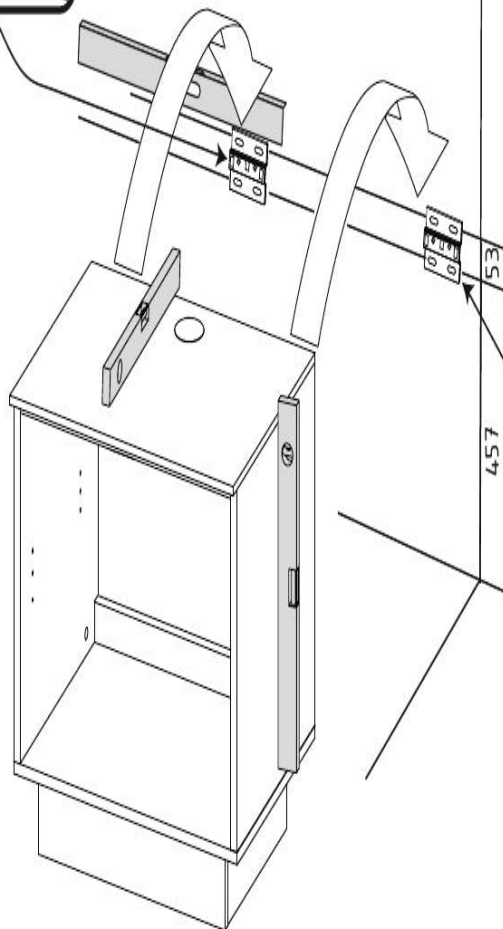
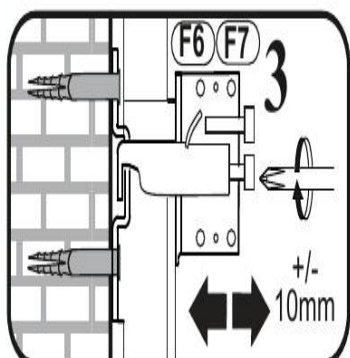
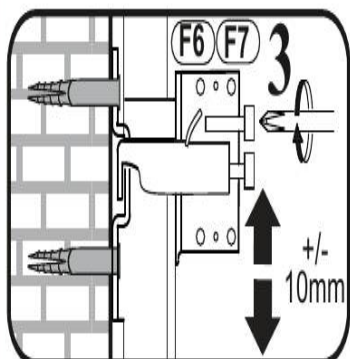
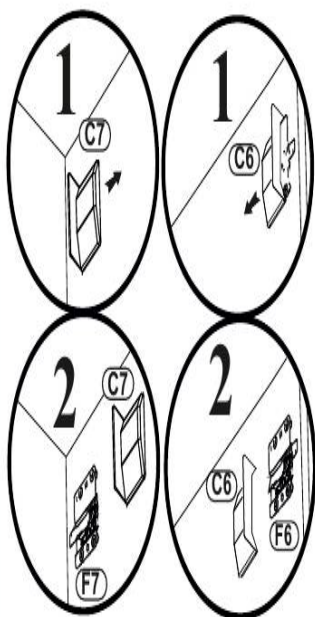
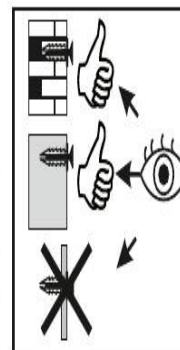
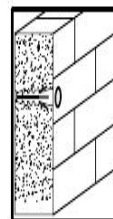
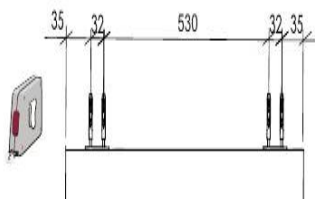
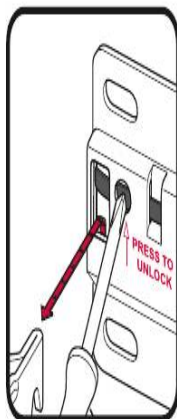
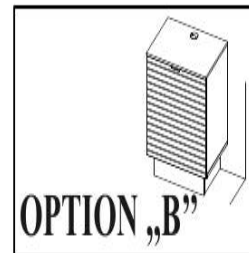
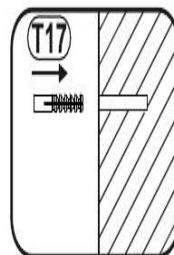
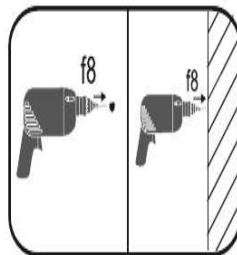
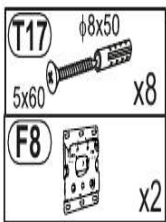

15

