

CELINA

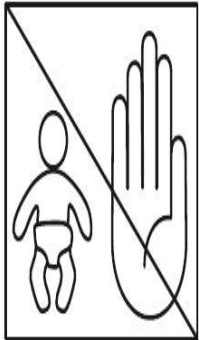

LEVÁ/LAVÁ PRAVÁ

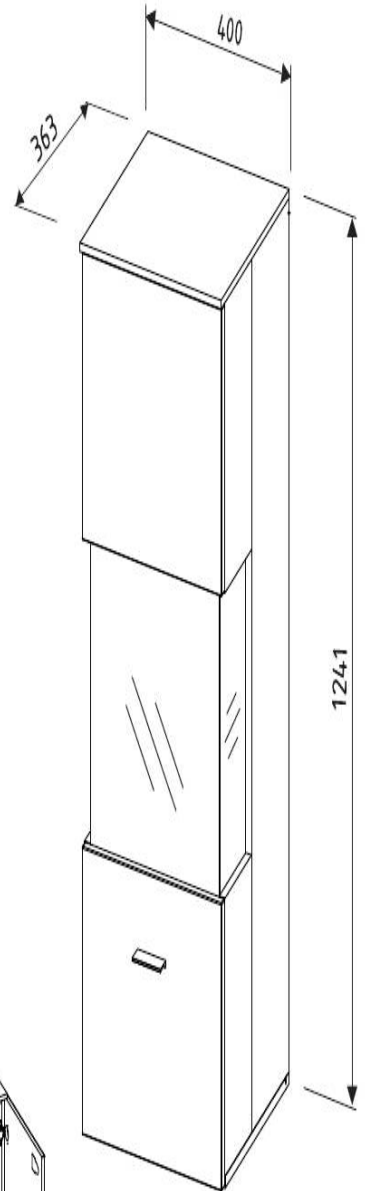
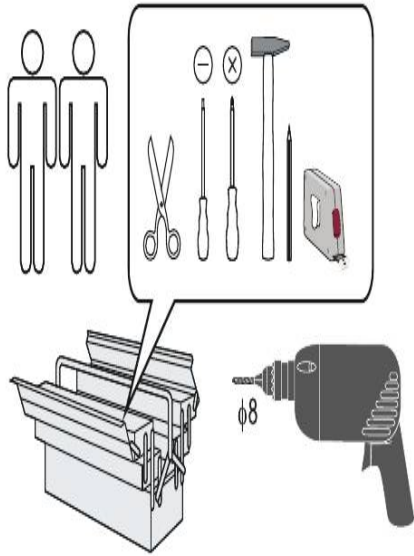
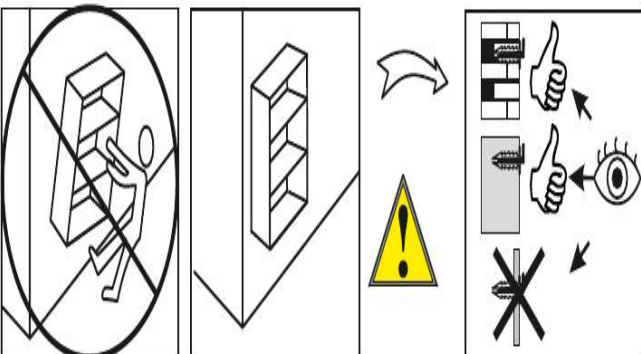
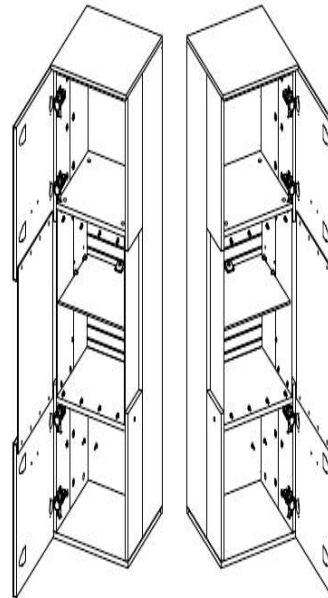
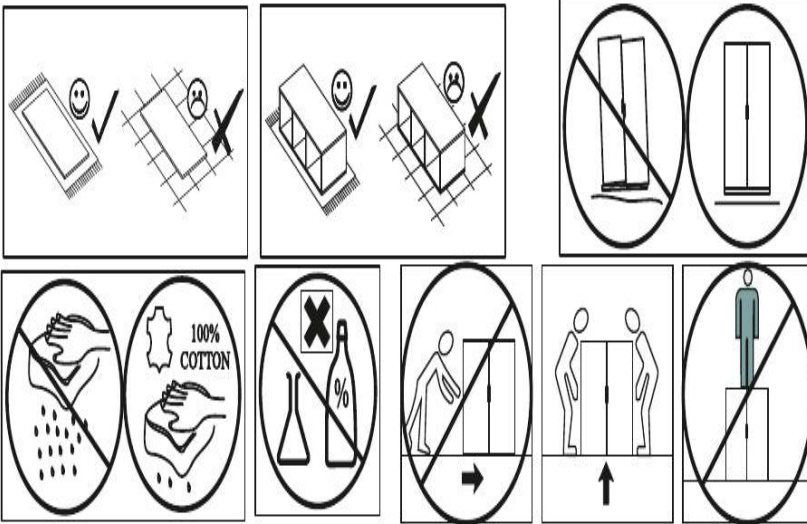

<https://quejairedemesdechets.fr>

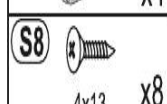
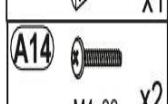
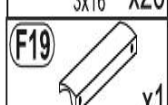
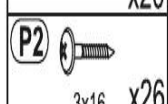
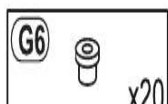
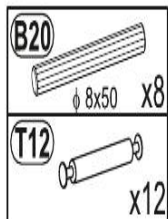
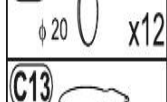
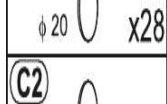
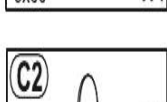
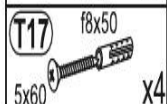
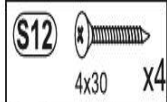
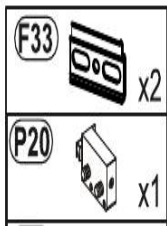
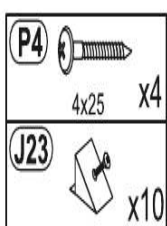
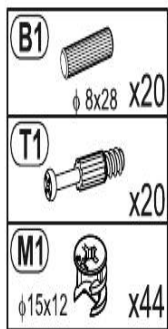

Nr	↙	↖	↗	pcs	
1	1213	205	16	1	2
2	404	134	16	1	1
3	385	134	16	1	1
4	1213	205	16	1	2
5	404	134	16	1	1
6	385	134	16	1	1
7	366	318	16	1	1
8	400	340	16	1	1
9	366	314	16	2	1
10	354	285	6	1	1
11	484	364	4	1	1
12	400	363	12	1	1
13	380	370	2	1	1
14	366	486	16	1	1
15	380	364	2	1	1
16	474	159	4	2	1
17	400	396	16	1	2
18	400	396	16	1	2

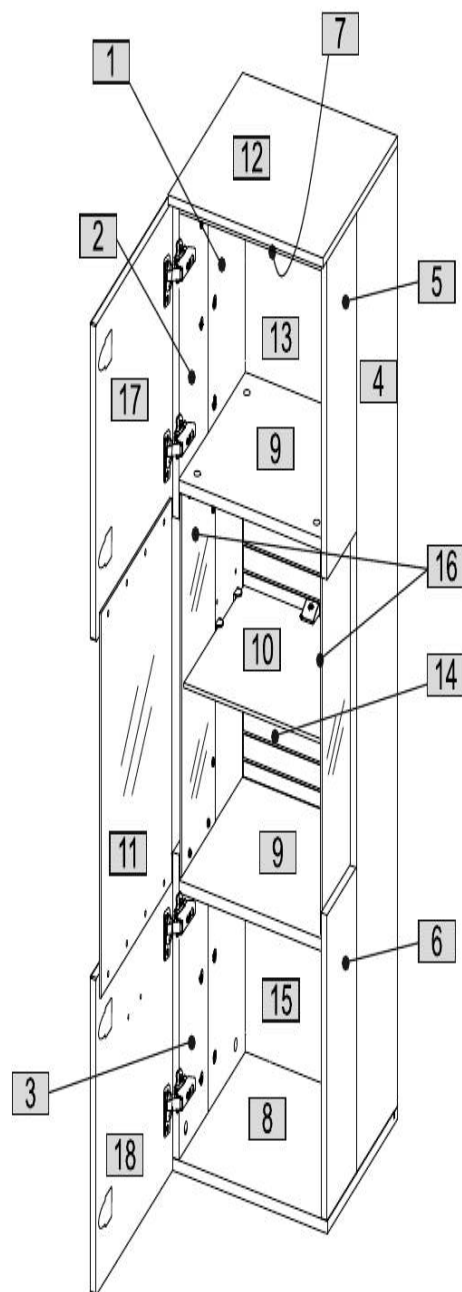

0 10 20 30 40 50 60 70 80 90 100 110 120 130 140 150 160 170 180 190 200

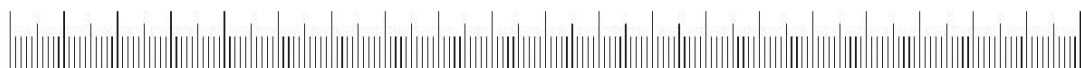

1

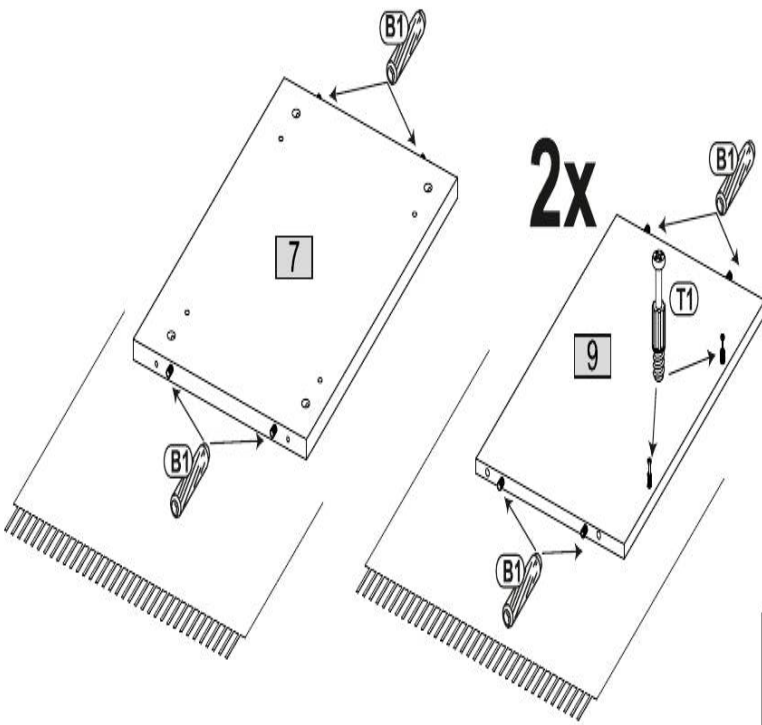
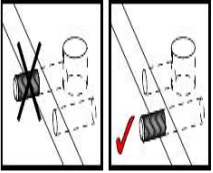
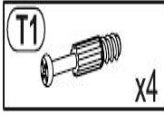
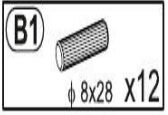

2

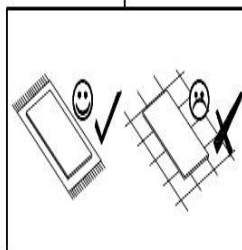
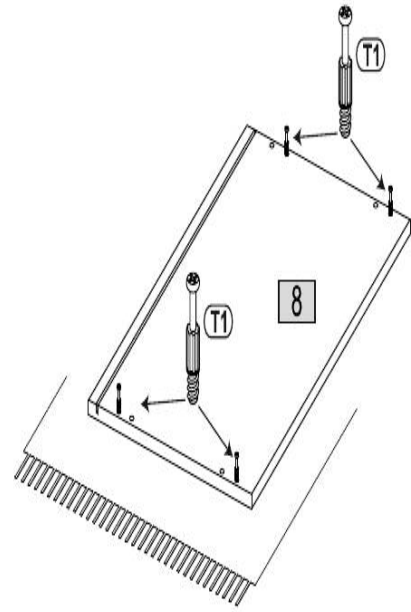
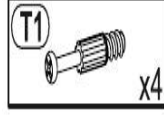

3

S12 4x30 X4

T1 X6

B20 ϕ 8x50 X4

P20 X1

B1 ϕ 8x28 X4

P21 X1

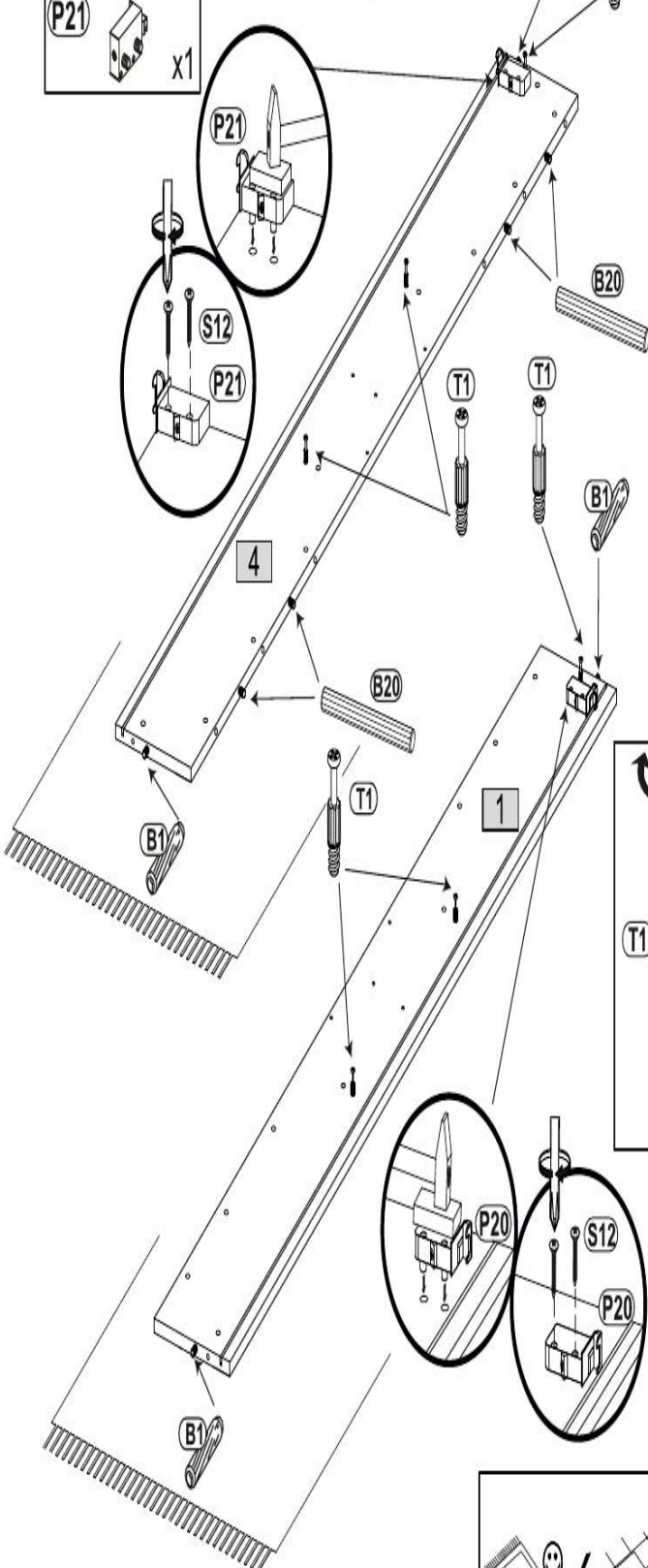

4

B1 ϕ 8x28 X4

T1 X6

B20 ϕ 8x50 X4

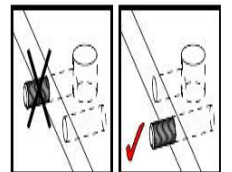
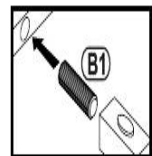
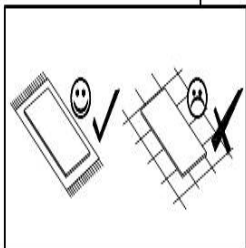
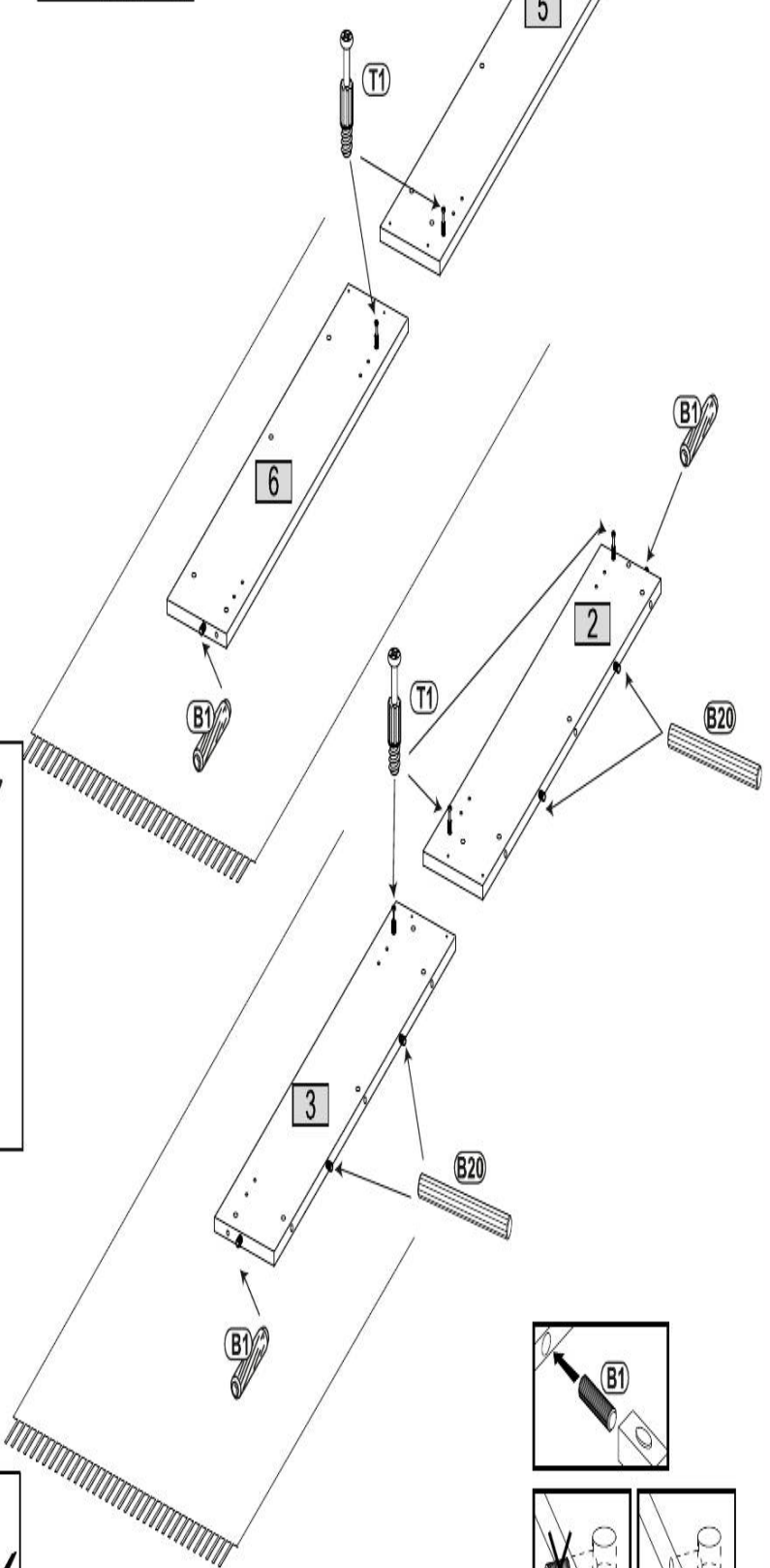

5

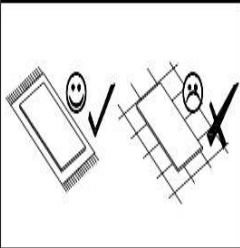
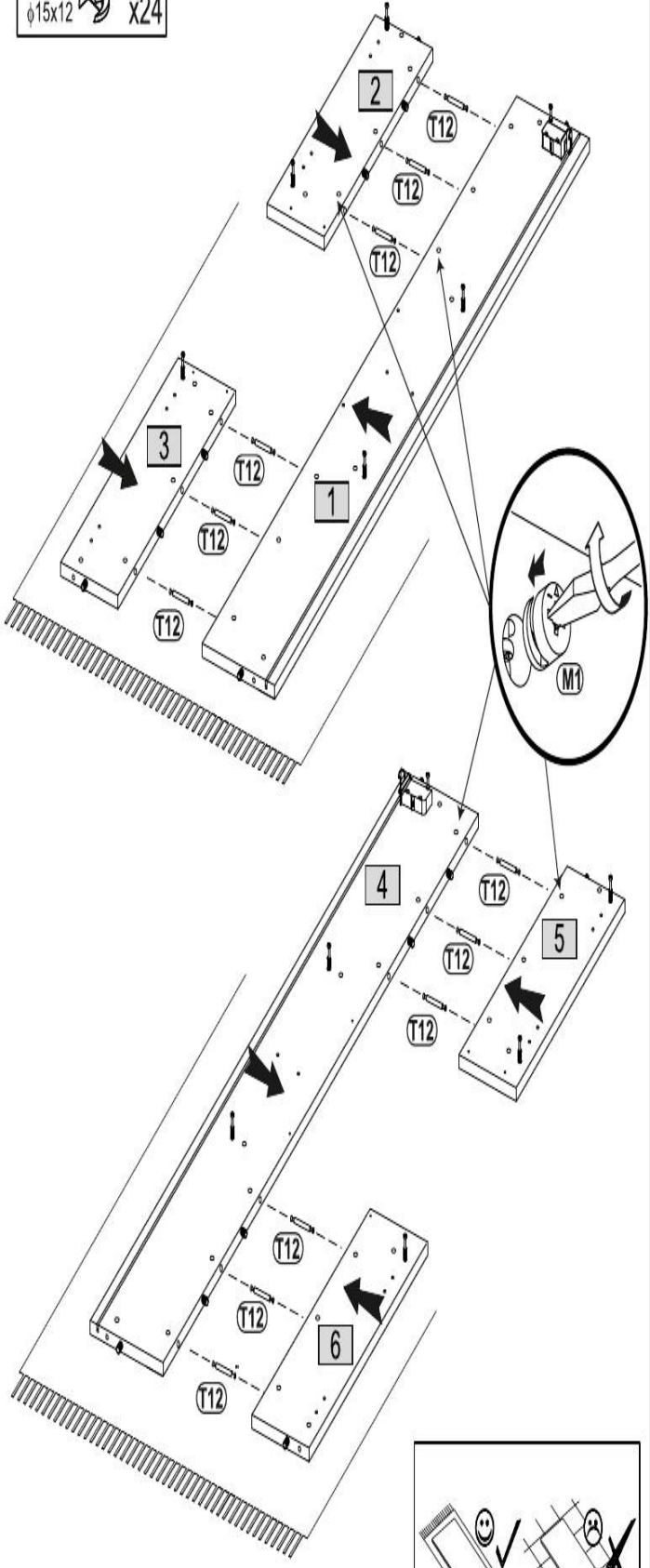
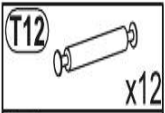

6

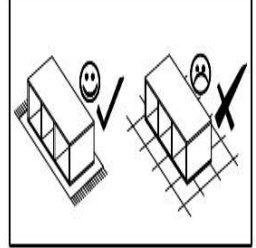
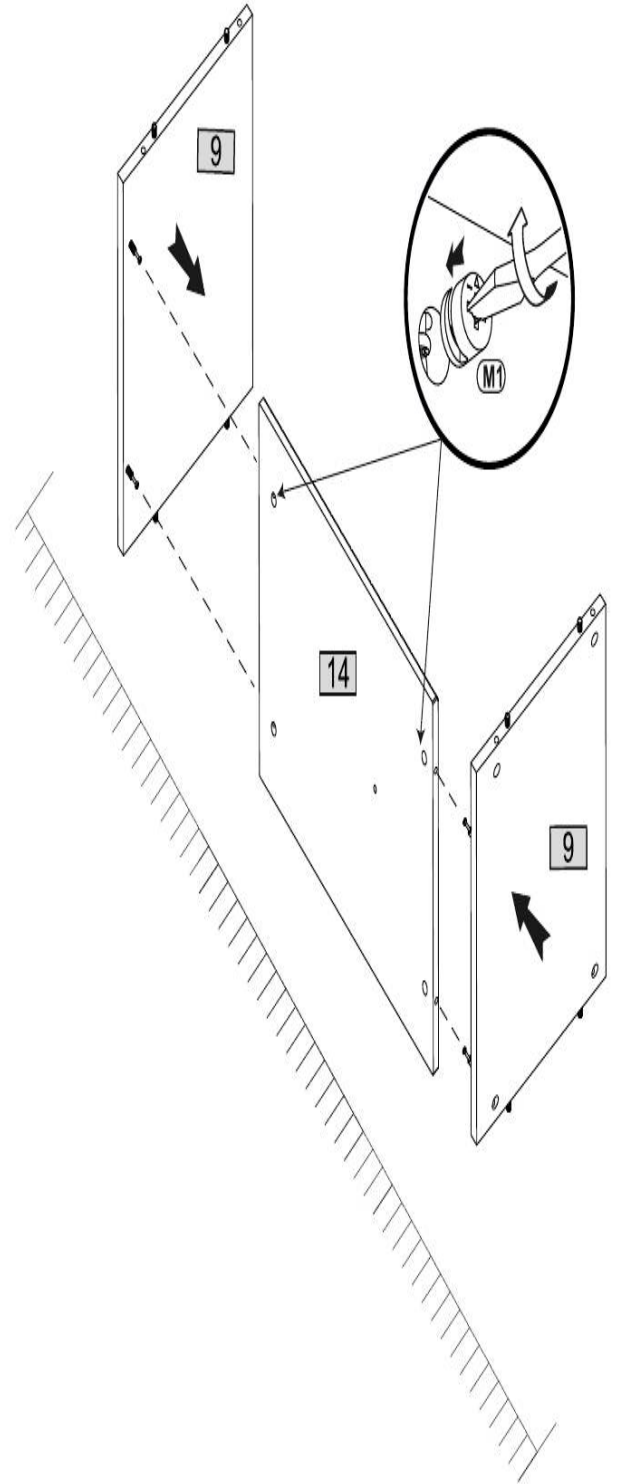

7

- G6 x12
- P2 3x16 x12

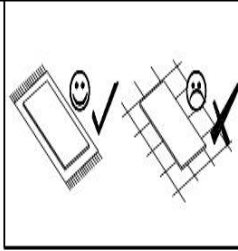

8

- Z2c x4
- S8 4x13 x8
- G6 x8
- P2 3x16 x8
- C13 φ35 x4

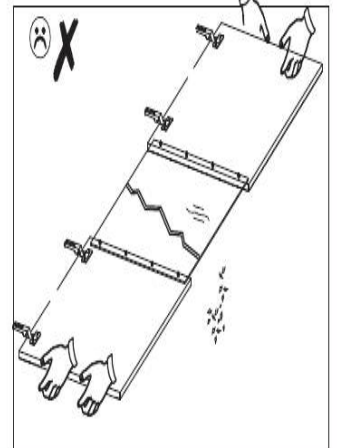
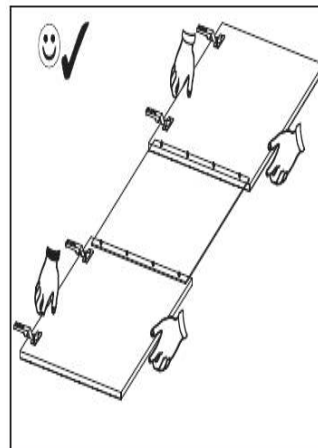
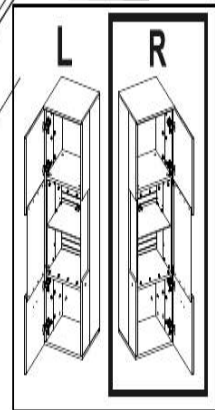
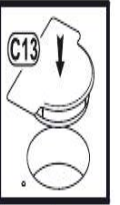
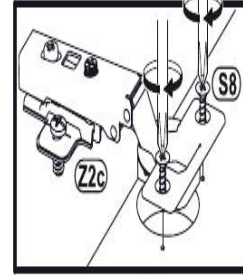
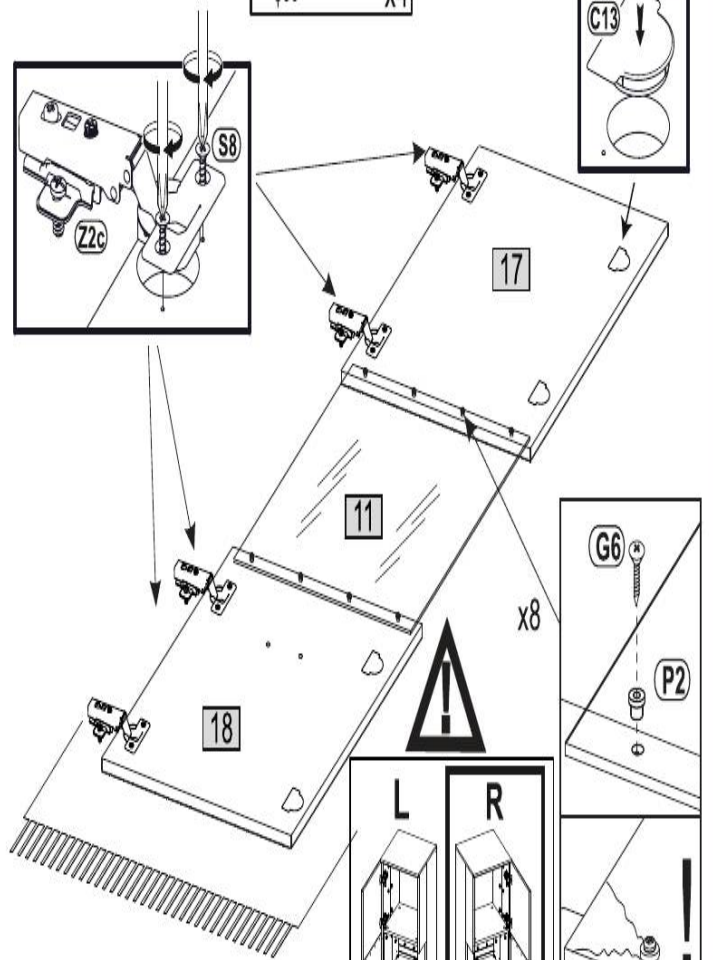
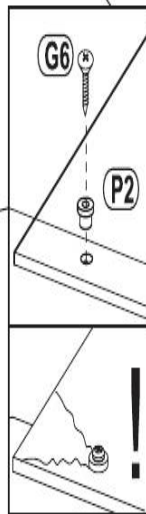
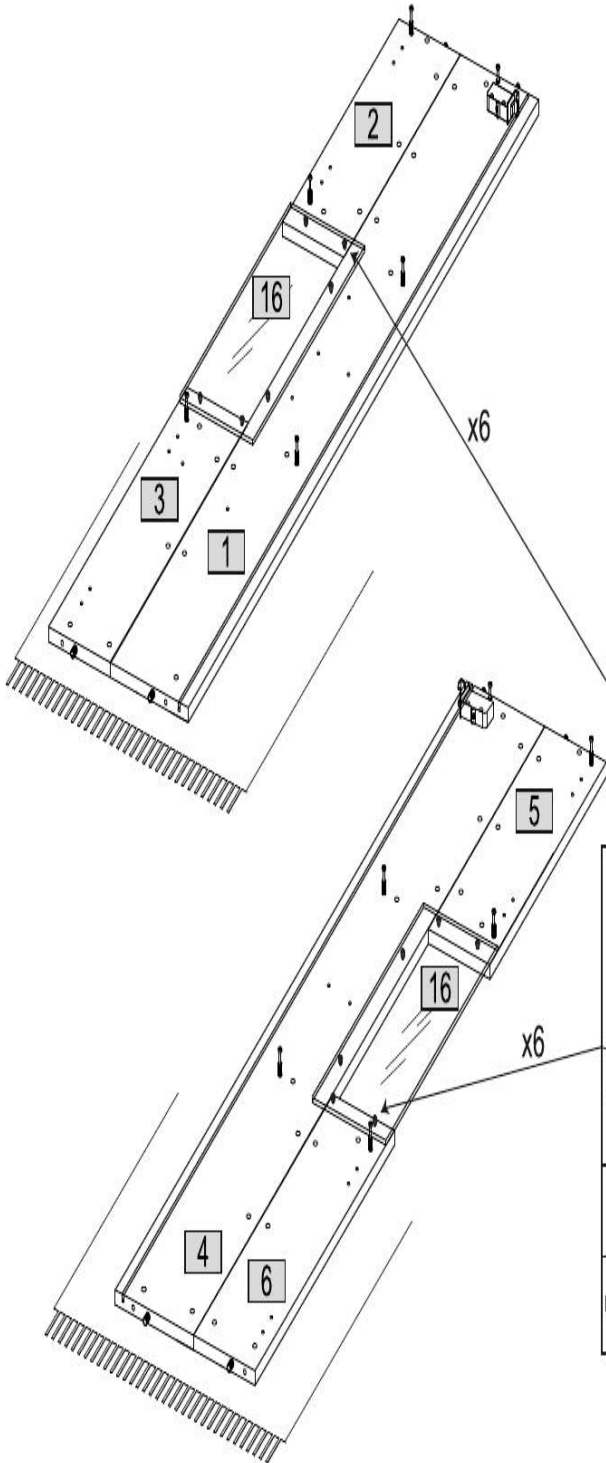
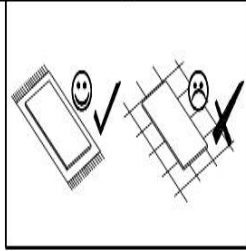

9

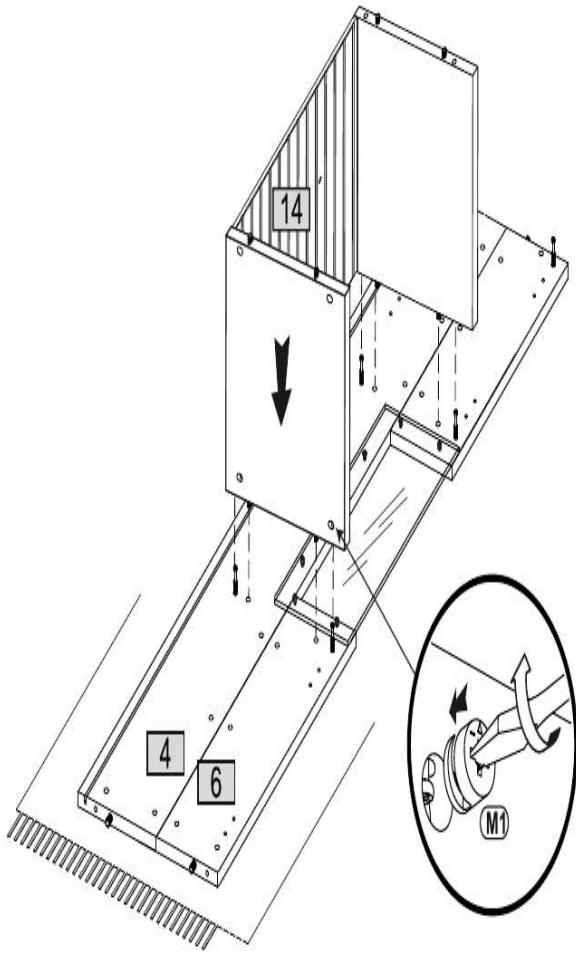

10

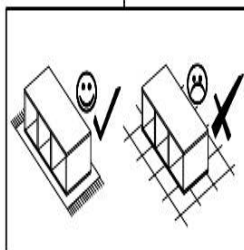
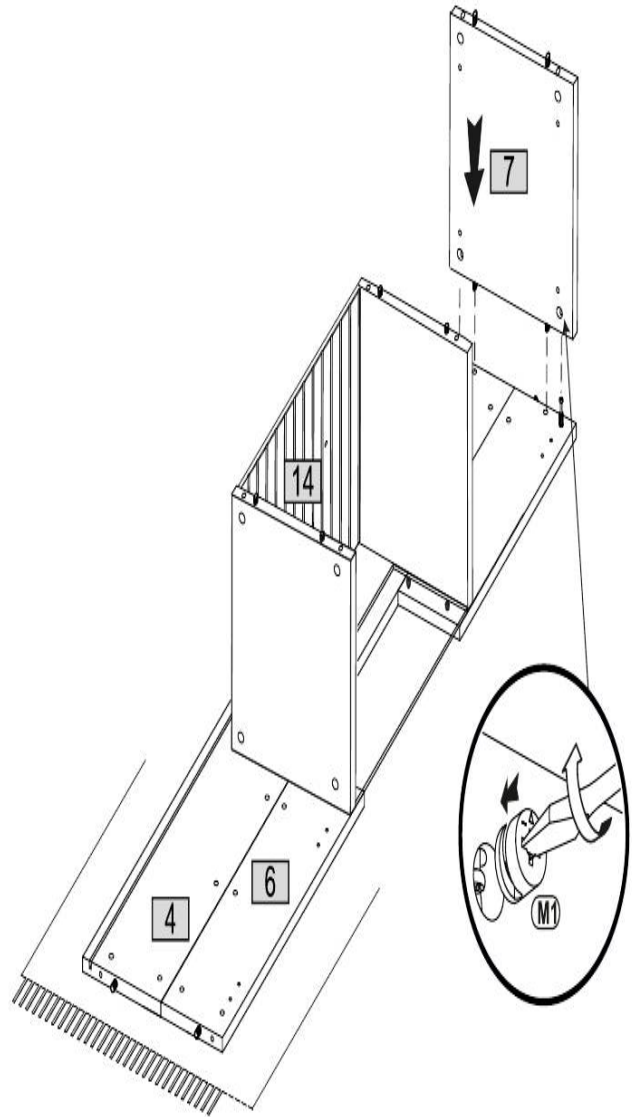

11

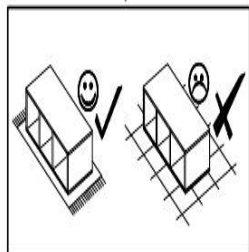
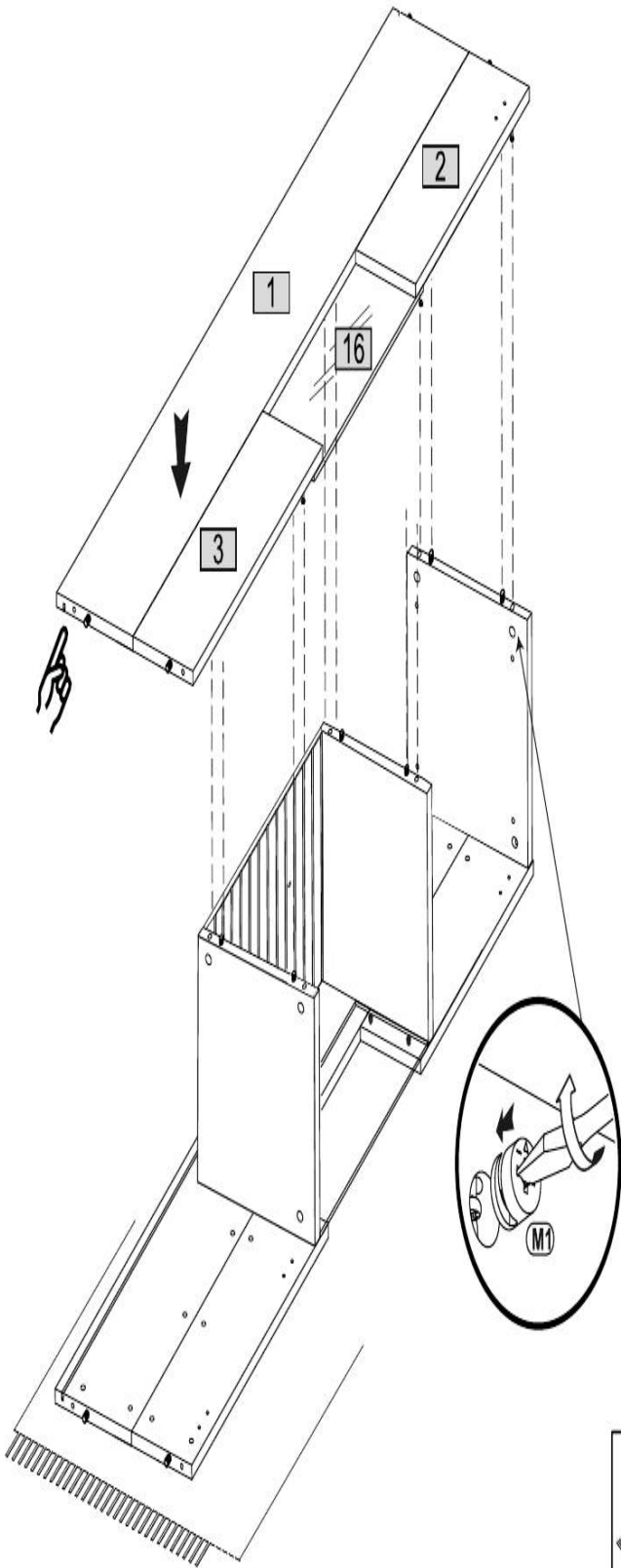

12

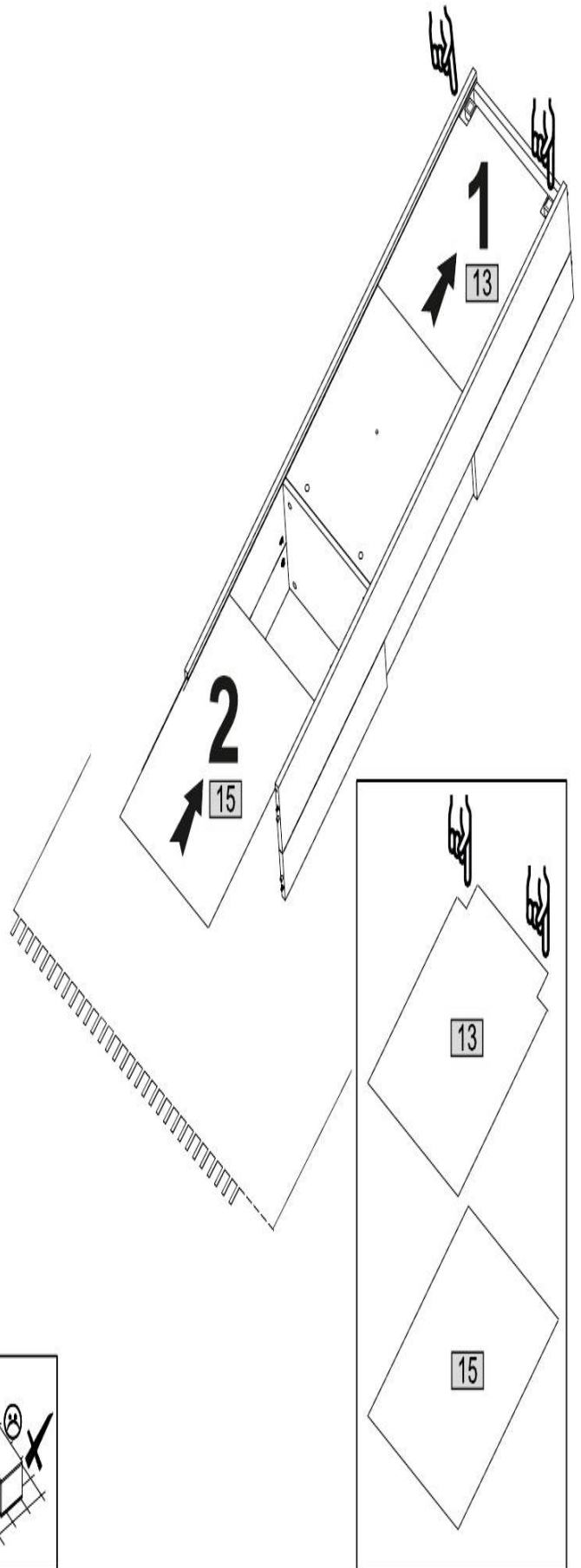

13

M1
φ15x12
x4

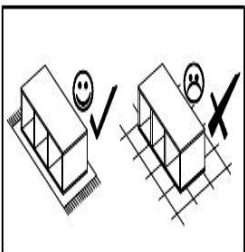
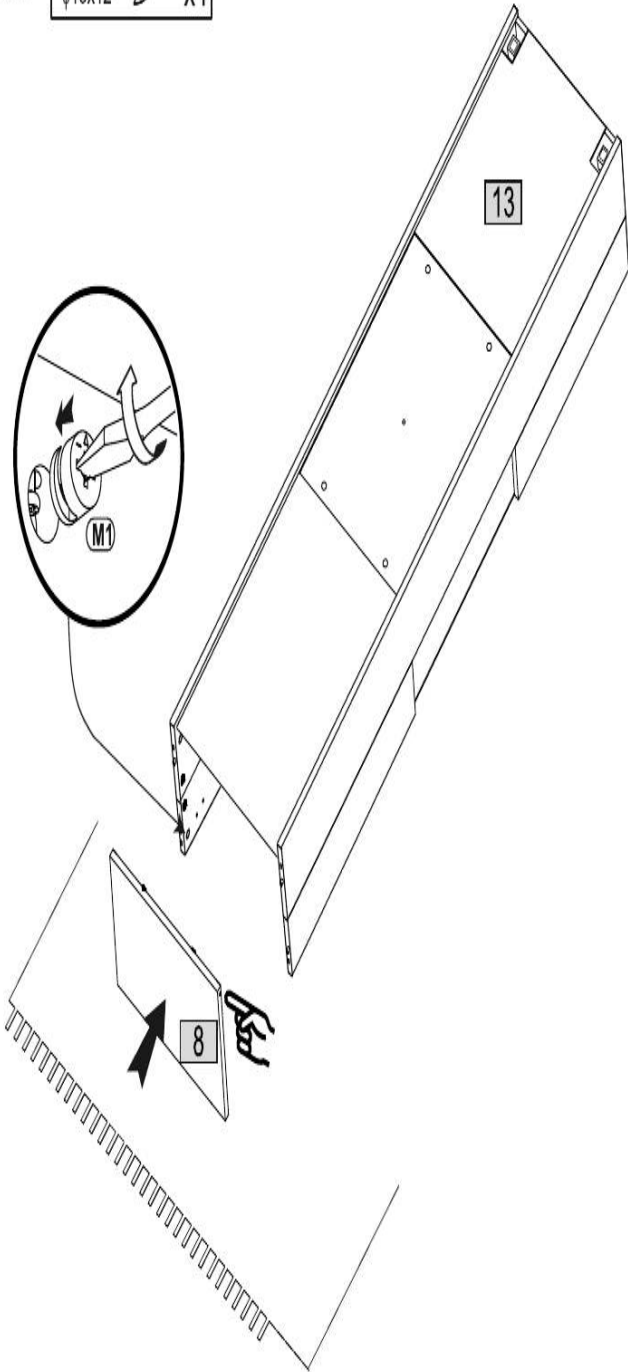

14

J23
x10
P2
3x16
x6

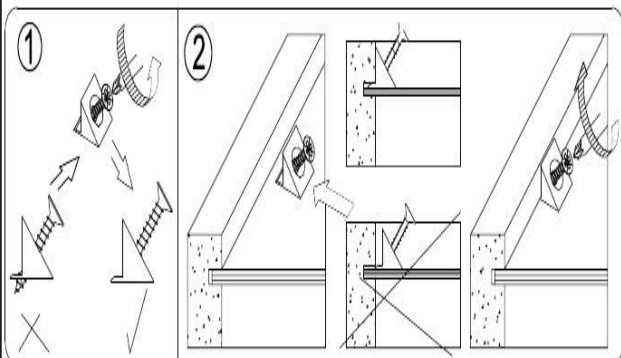
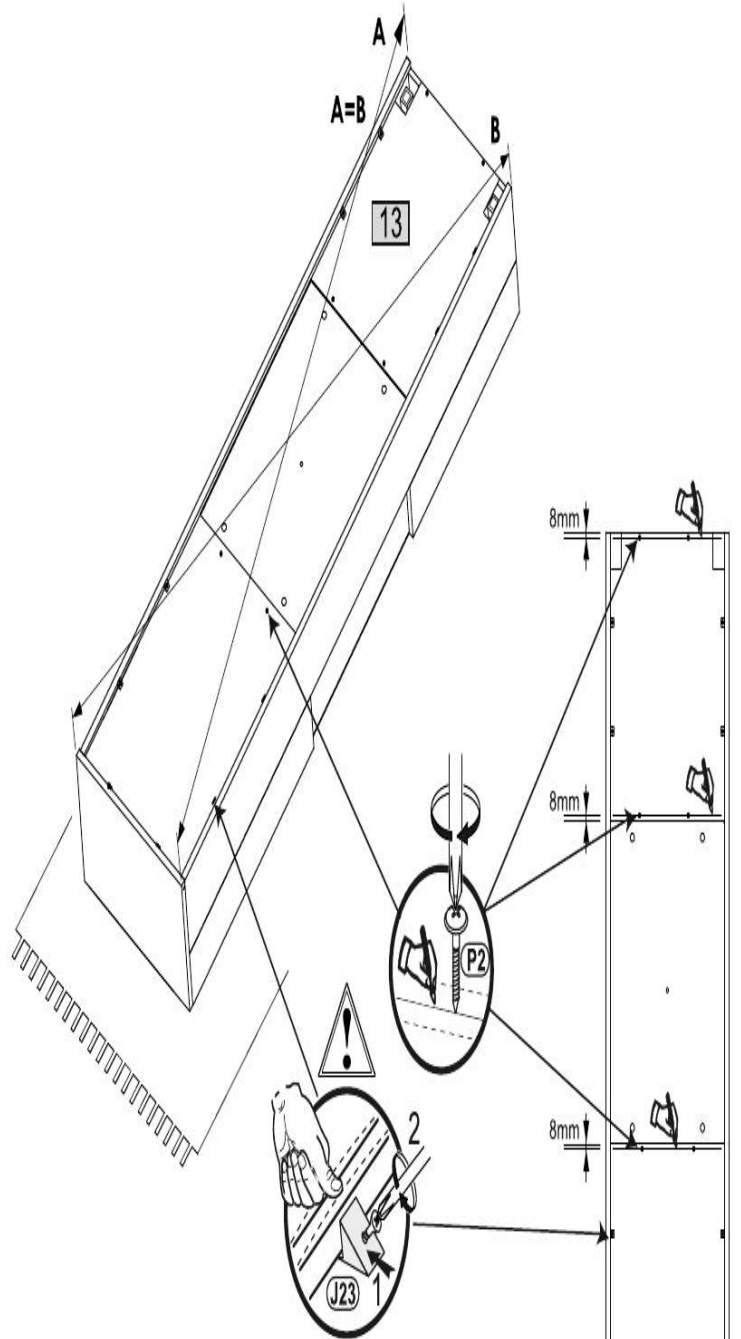
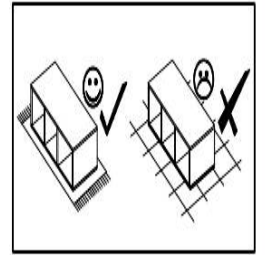

15 **P4** 4x25 X4

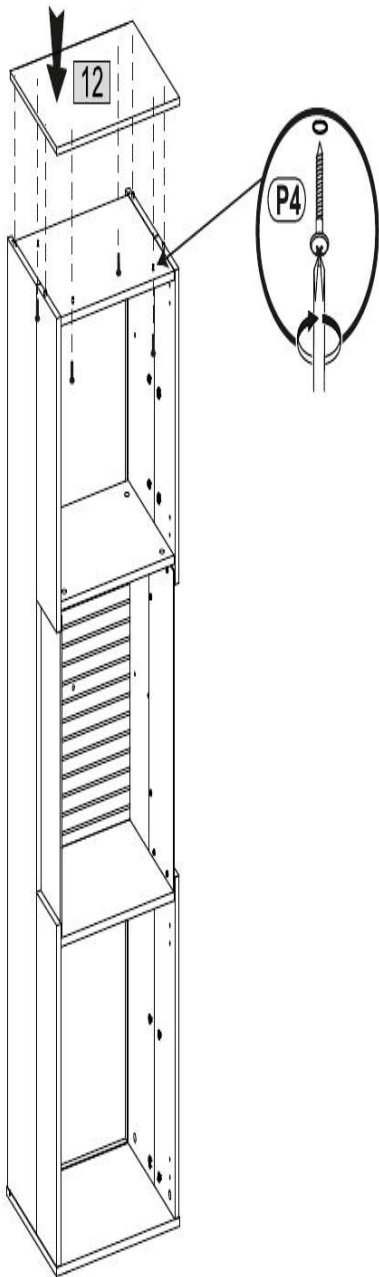

16 **W12** X4 **C2** ϕ 20 X28 **C2** ϕ 20 X12

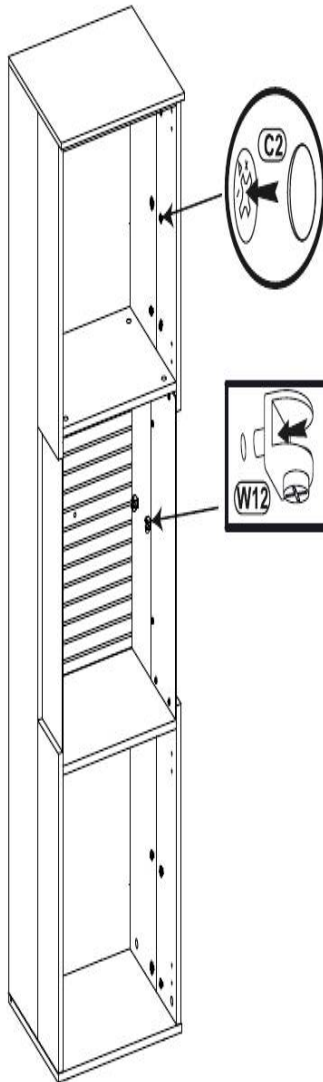

17 **O48** X1 **O51** X1
SOK-OSW
-026-1

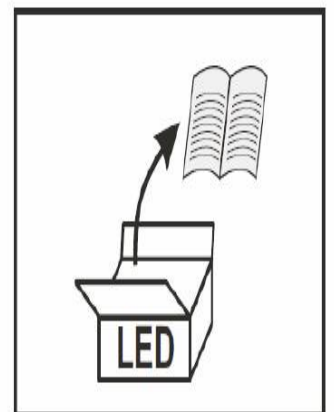
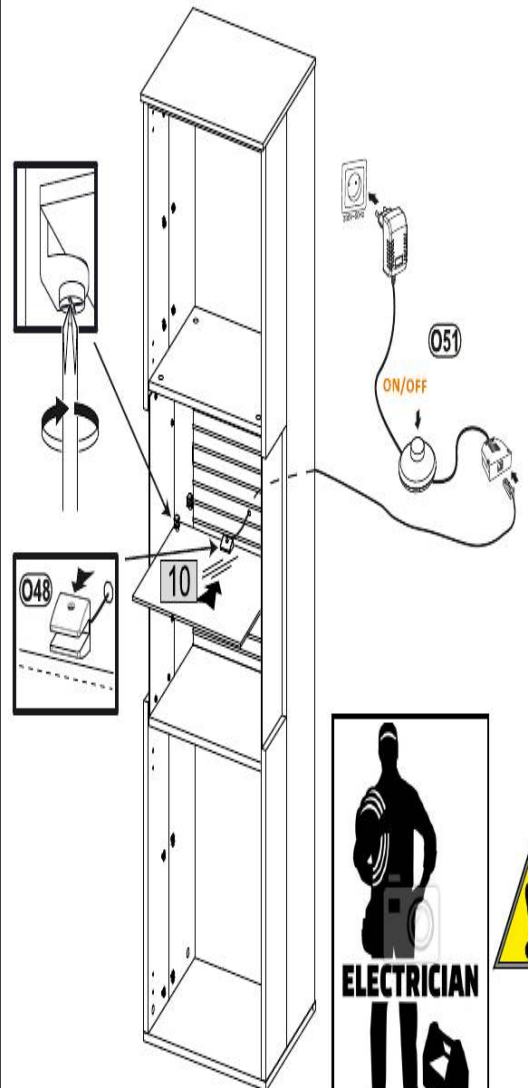

- 18** **F19**  x1
- A14**  M4x22 x2
- F33**  x2
- T17**  $\phi 8 \times 50$ 5x60 x4

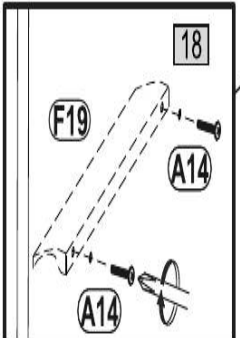
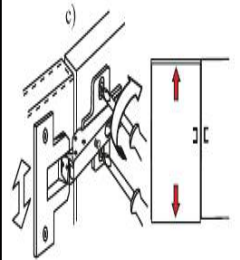
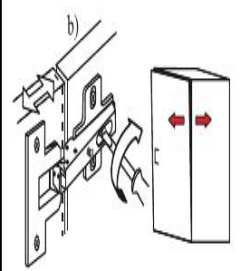
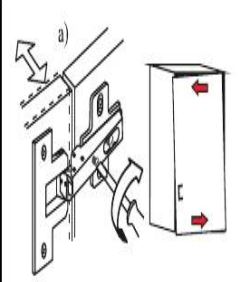
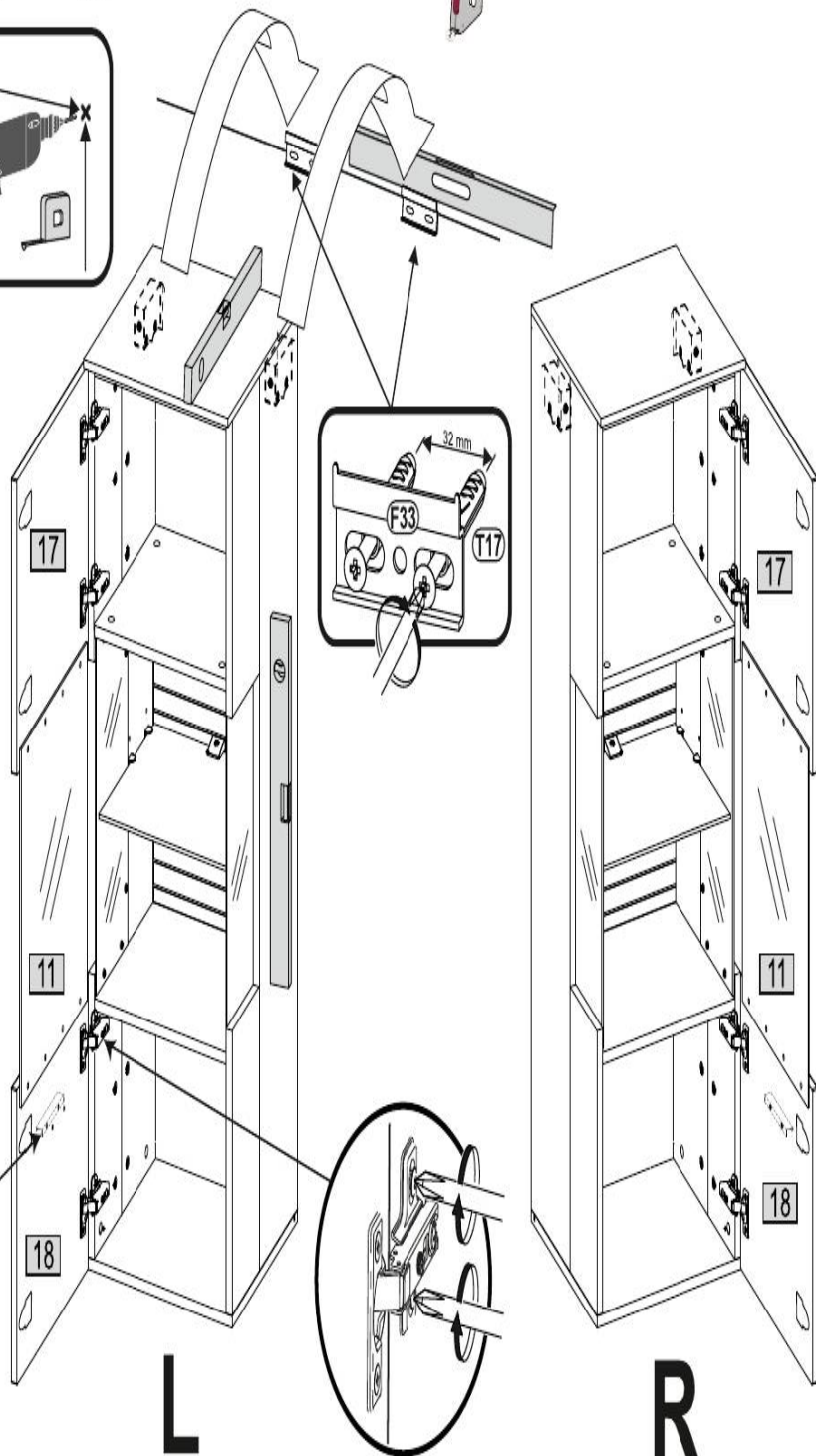
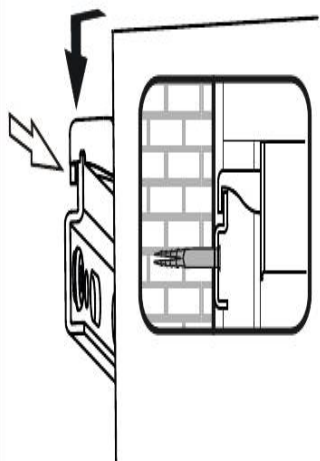
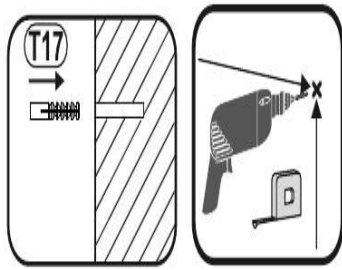
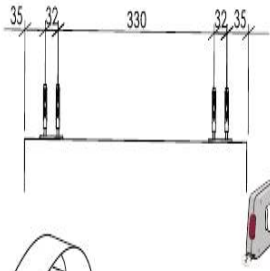
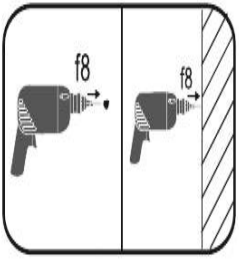
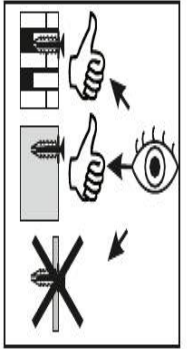
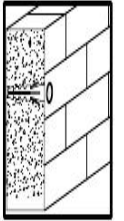

L

R

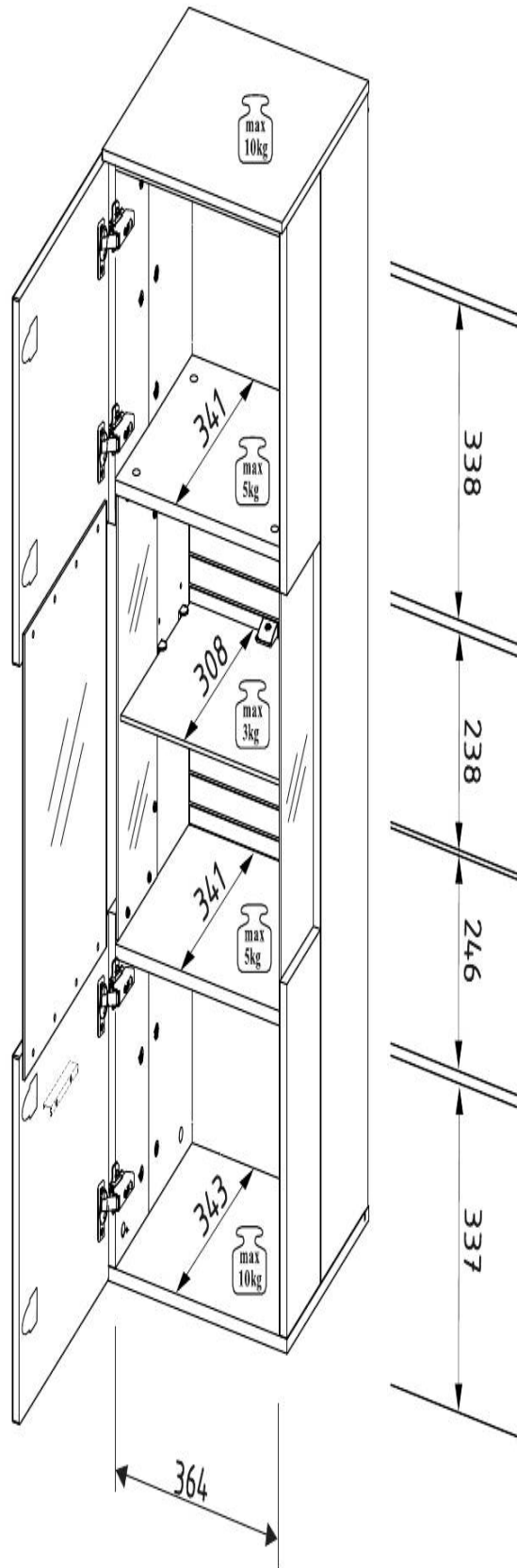

SOK-OSW-026-1

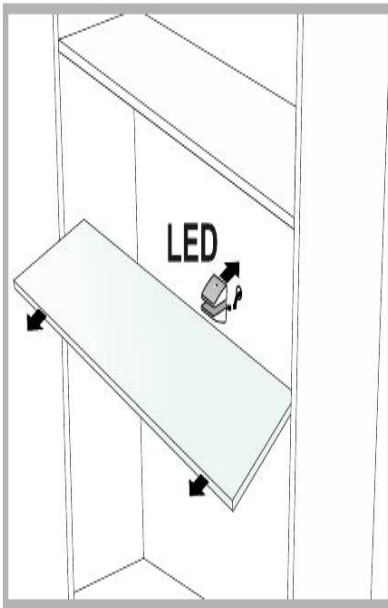
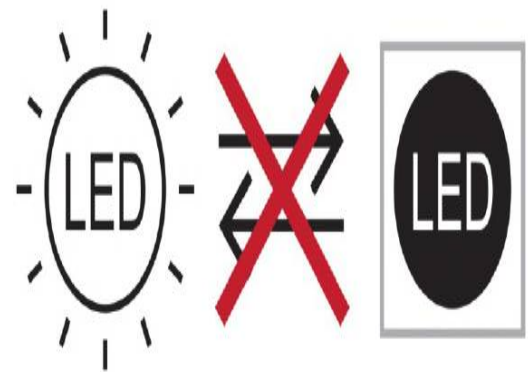

PL- Produkty te zawierają źródła światła, które ze względu na swoje właściwości nie podlegają rozporządzeniu (UE) 2019/2015	DE- Diese Produkte enthalten Lichtquellen, die aufgrund ihrer Eigenschaften nicht unter die Verordnung (EU) 2019/2015 fallen	CS- Tyto výrobky obsahují světelné zdroje, které vzhledem ke svým vlastnostem nespádají do oblasti působnosti nařízení (EU) 2019/2015
DA- Disse produkter indeholder lyskilder, som på grund af deres egenskaber er uden for anvendelsesområdet for forordning (EU) 2019/2015	EL- Αυτά τα προϊόντα περιέχουν πηγές φωτός οι οποίες, λόγω των ιδιοτήτων τους, δεν εμπίπτουν στο πεδίο εφαρμογής του κανονισμού (UE) 2019/2015	EN- These products contain light sources which, due to their properties, are out of the scope of Regulation (EU) 2019/2015
ES- Estos productos contienen fuentes de luz que, por sus propiedades, quedan fuera del ámbito de aplicación del Reglamento (UE) 2019/2015.	ET- Need tooted sisaldavad valgusallikaid, mis oma omaduste tõttu jäävad määruse (UE) 2019/2015 reguleerimisalast välja	FI- Nämä tuotteet sisältävät valonlähteitä, jotka ominaisuuksiensa vuoksi eivät kuulu asetuksen (EU) 2019/2015 soveltamisalaa
FR- Ces produits contiennent des sources lumineuses qui, en raison de leurs propriétés, n'entrent pas dans le champ d'application du règlement (UE) 2019/2015	HU- Ezek a termékek olyan fényforrásokat tartalmaznak, amelyek tulajdonságaik miatt nem tartoznak az (EU) 2019/2015 rendelet hatálya alá	IT- Questi prodotti contengono sorgenti luminose che, per le loro proprietà, esulano dal campo di applicazione del Regolamento (UE) 2019/2015
LT- Šiuose gaminių ypa šviesos šaltinių, kurie dėl savo savybių nepatenka į Reglamento (UE) 2019/2015 taikymo sritį	LV- Šie produkti satur gaismas avotus, kas to īpašību dēļ ir ārpus Regulas (UE) 2019/2015 darbības jomas	RU- Эти продукты содержат источники света, которые из-за своих свойств не подпадают под действие Регламента (ЕС) 2019/2015.
PT- Estes produtos contêm fontes de luz que, devido às suas propriedades, estão fora do âmbito do Regulamento (UE) 2019/2015	RO- Aceste produse conțin surse de lumină care, datorită proprietăților lor, nu intră în domeniul de aplicare al Regulamentului (UE) 2019/2015	NL- Deze producten bevatten lichtbronnen die vanwege hun eigenschappen buiten het toepassingsgebied van Verordening (EU) 2019/2015 vallen
SK- Tieto výrobky obsahujú svetelné zdroje, ktoré vzhľadom na svoje vlastnosti nepatria do rozsahu pôsobnosti nariadenia (EÚ) 2019/2015	SLO- Ti izdelki vsebujejo svetlobne vire, ki zaradi svojih lastnosti ne spadajo na področje uporabe Uredbe (EU) 2019/2015	SV- Dessa produkter innehåller ljuskällor som på grund av sina egenskaper inte omfattas av förordning (EU) 2019/2015
TR- Bu ürünler, özellikleri nedeniyle (UE) 2019/2015 Yönetmeliğinin kapsamı dışında kalan ışık kaynakları içerir.	HR- Ovi proizvodi sadrže izvore svjetlosti koji zbog svojih svojstava nisu obuhvaćeni Uredbom (EU) 2019/2015	BG- Тези продукти съдържат източници на светлина, които поради своите свойства са извън обхвата на Регламент (ЕС) 2019/2015

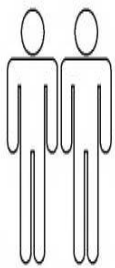



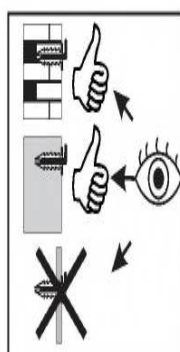
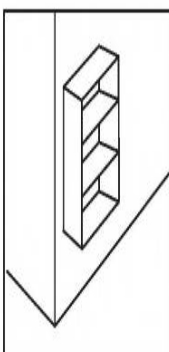
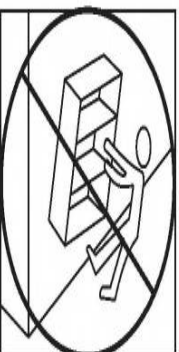
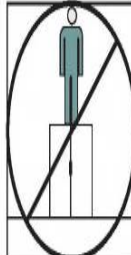
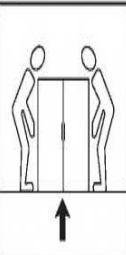
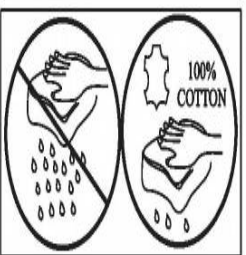
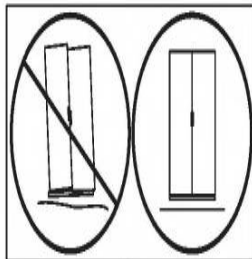
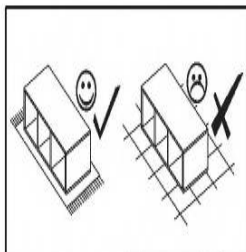
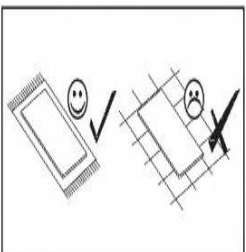
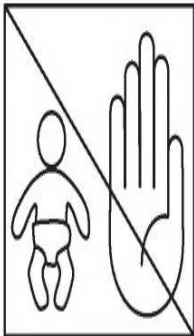
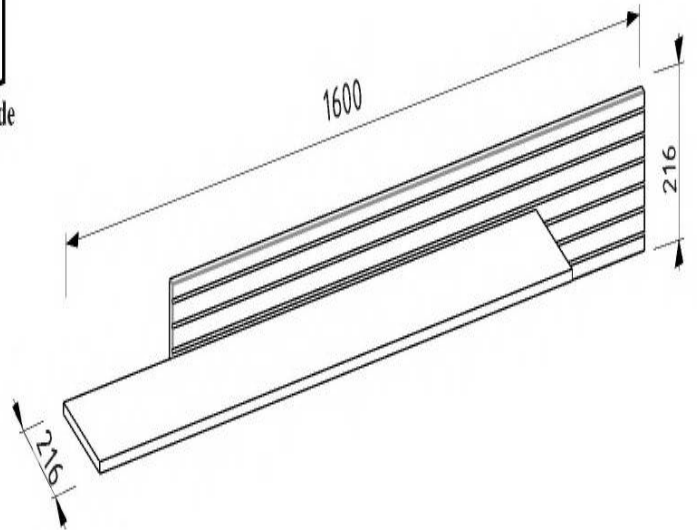
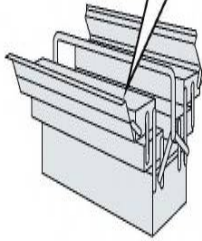

info@bega-consult.de

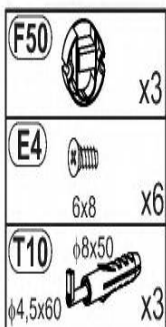
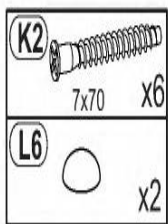

<https://quefairedemesdechets.fr>



Nr				pcs	
1	1300	200	16	1	1
2	1300	216	16	1	1

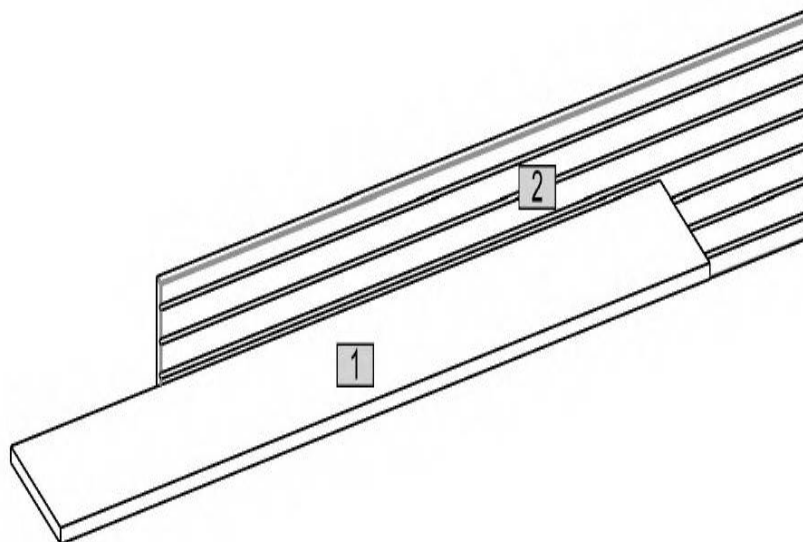
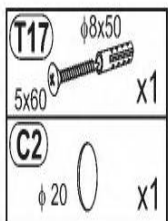

1

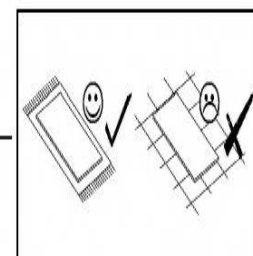
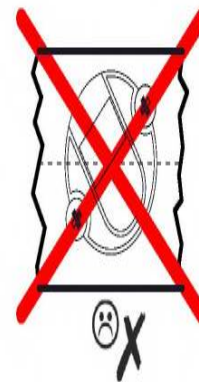
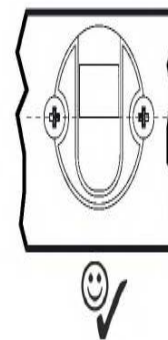
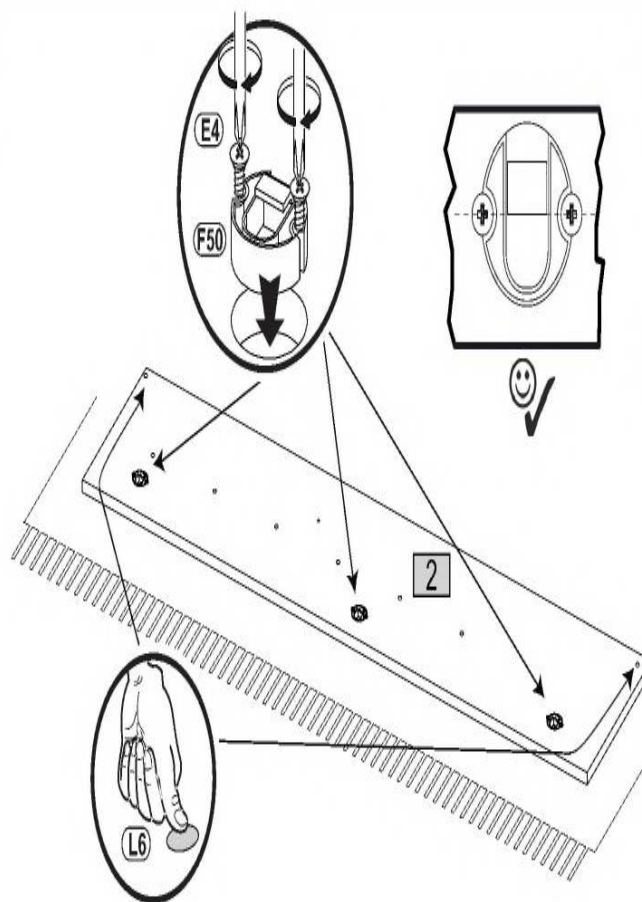
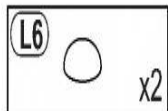
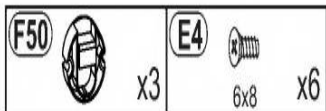

2

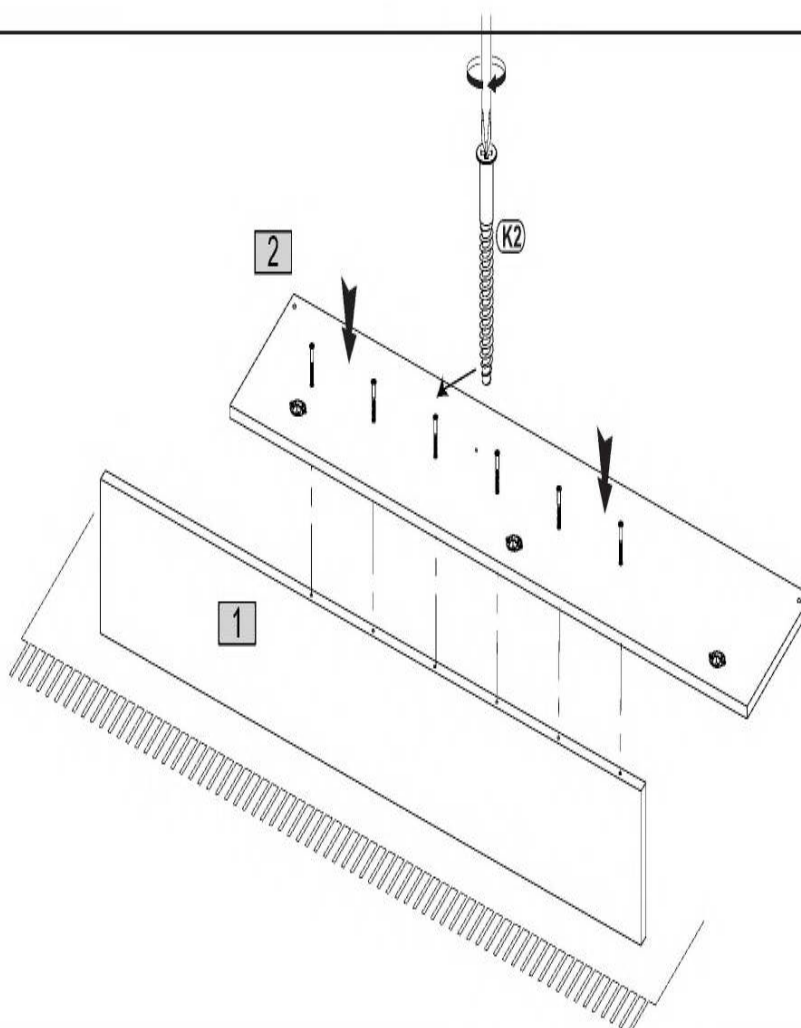
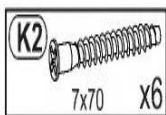

3

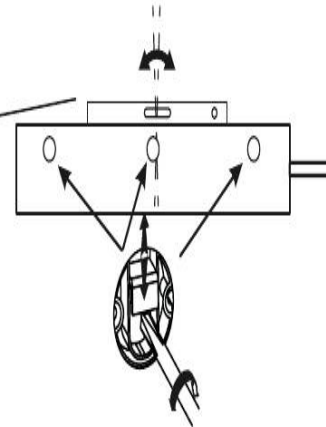
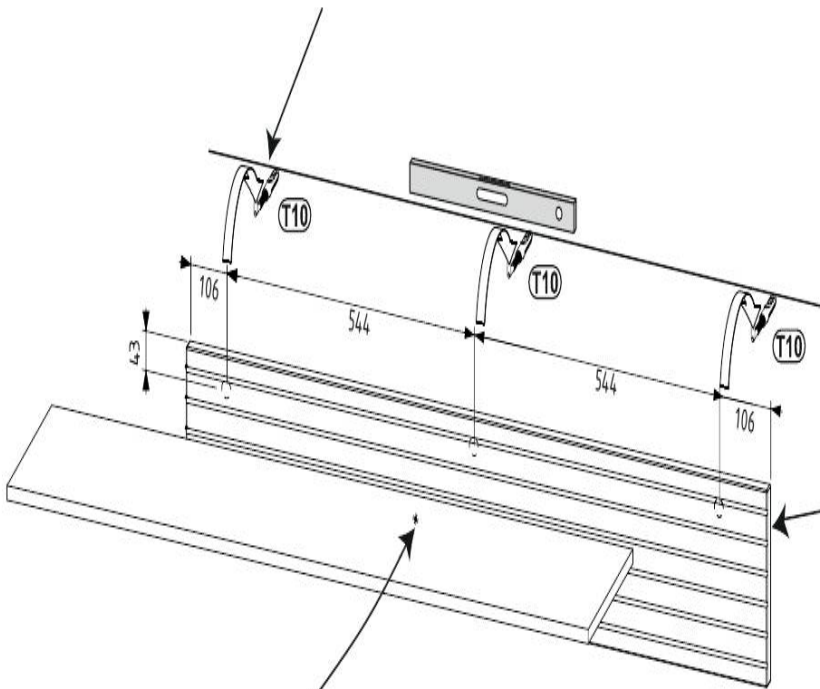
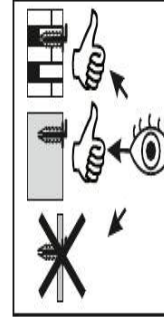
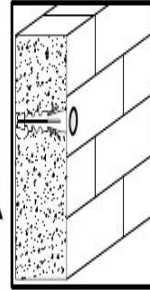
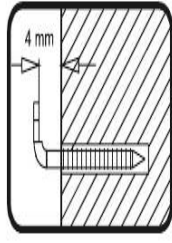
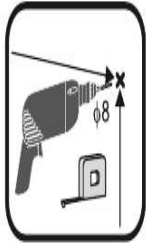
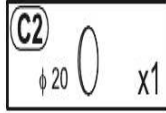
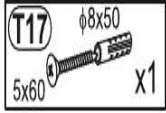
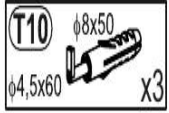

OPTIONAL

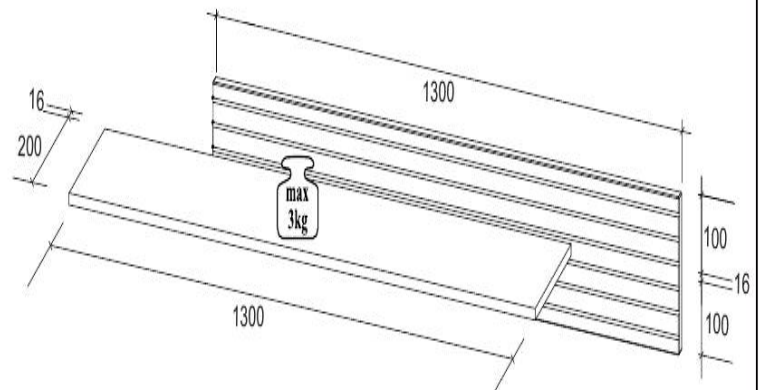
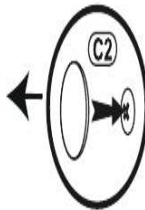
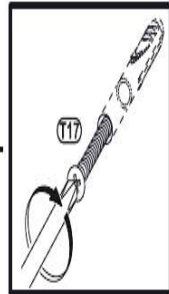
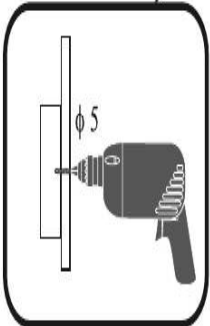

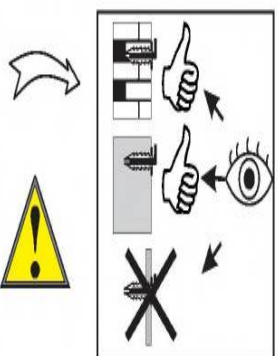
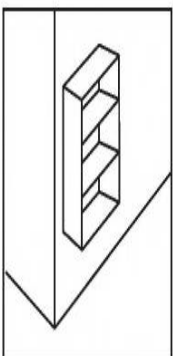
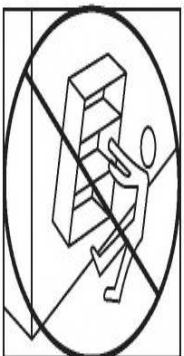
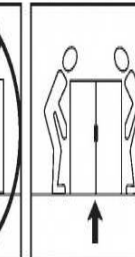
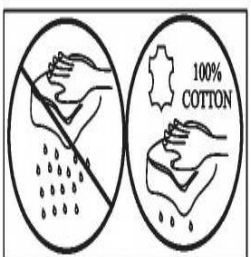
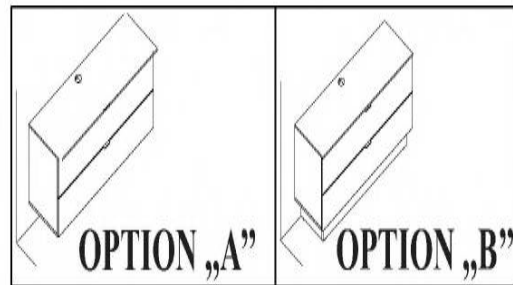
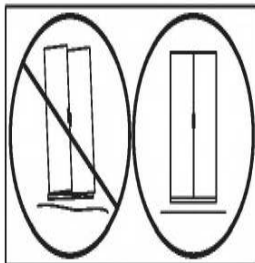
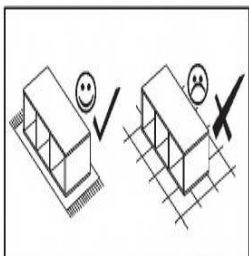
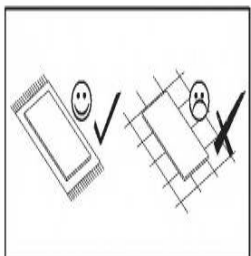
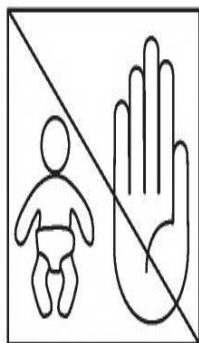
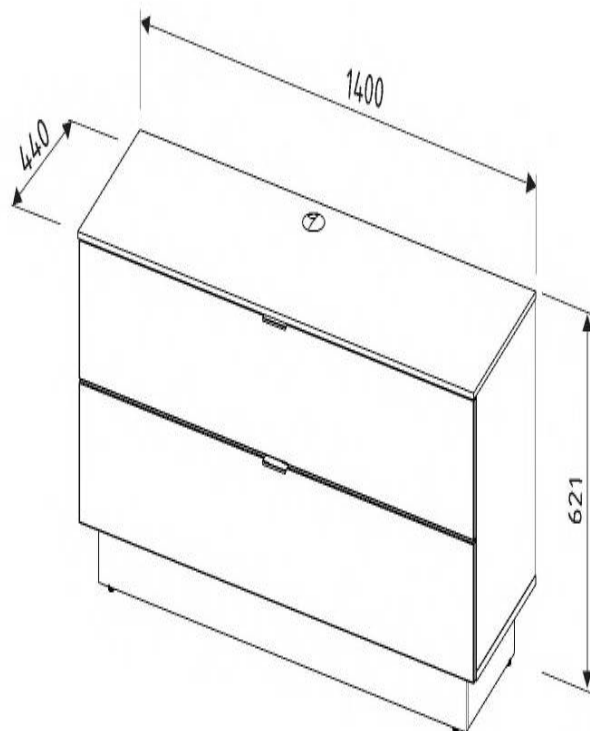
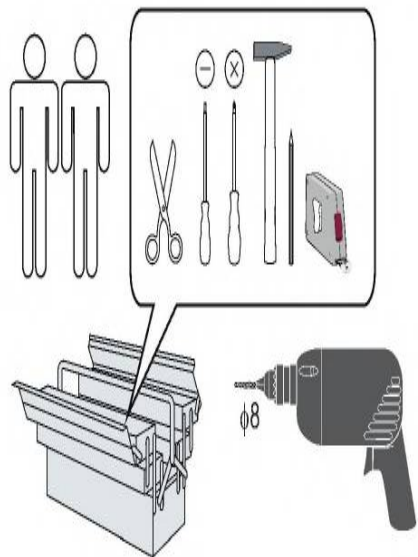

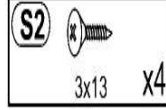
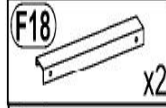
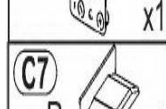
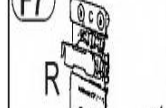
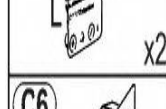
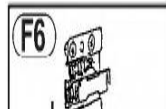
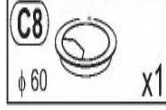
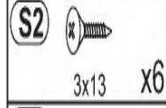
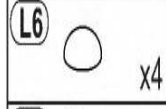
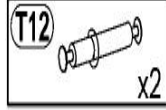
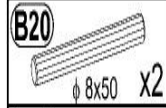
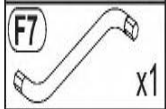
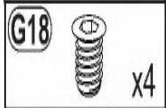
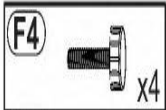
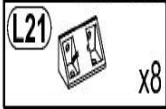
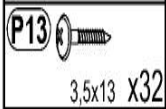
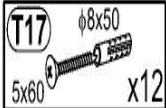
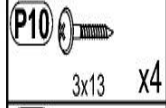
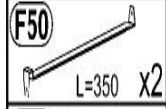
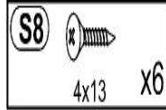
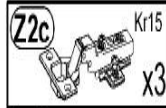
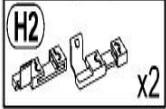
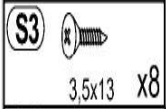
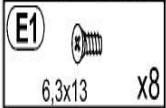
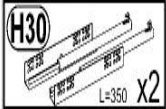
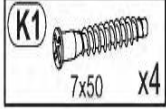
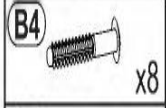
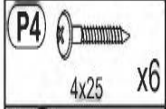
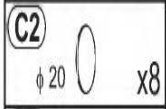
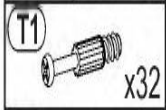

Nr	↙	↖	↗	pcs	☐
1	477	418	16	1	1
2	477	418	16	1	1
3	461	399	16	1	1
4	1366	399	16	1	2
5	1400	418	16	1	1
6	675	398	16	1	1
7	1400	440	12	1	2
8	1366	80	16	2	2
9	1266	110	16	1	2
10	326	110	16	1	1
11	1300	110	16	1	2
12	326	110	16	1	1
13	1396	242	16	1	1
14	350	140	12	2	1
15	350	140	12	2	1
16	635	140	12	2	1
17	1396	242	16	1	2
18	645	348	2	2	1
19	675	398	16	1	1

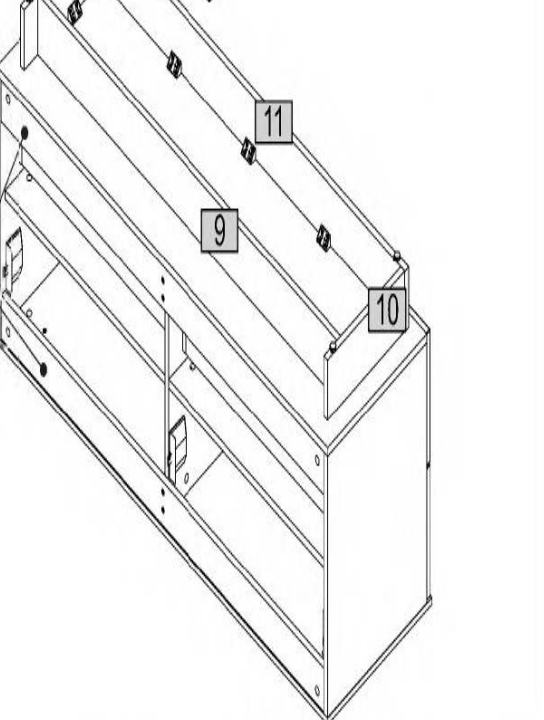
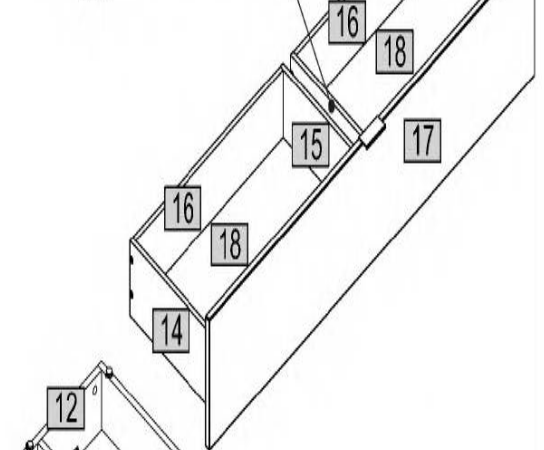
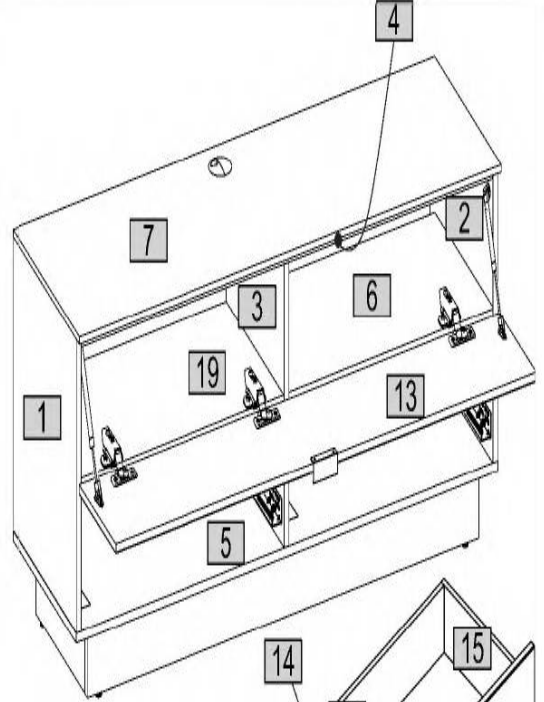

1

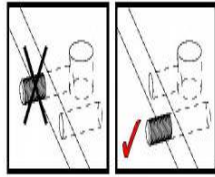
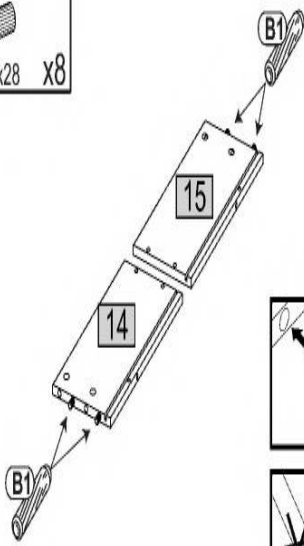
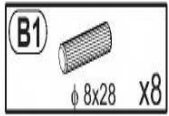

x2 x2

2

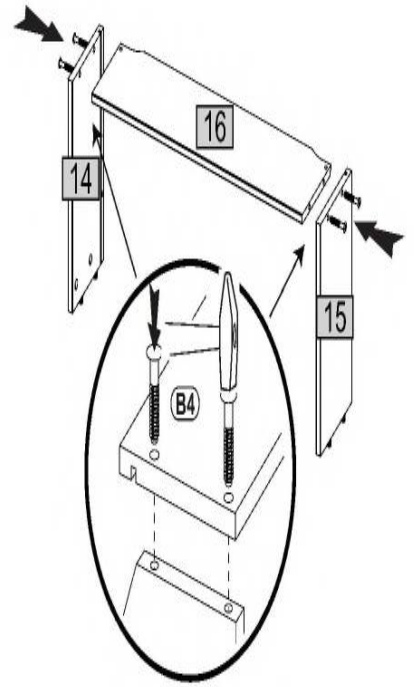
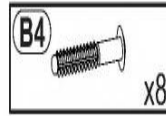

3

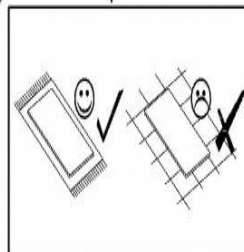
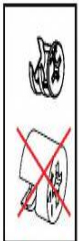
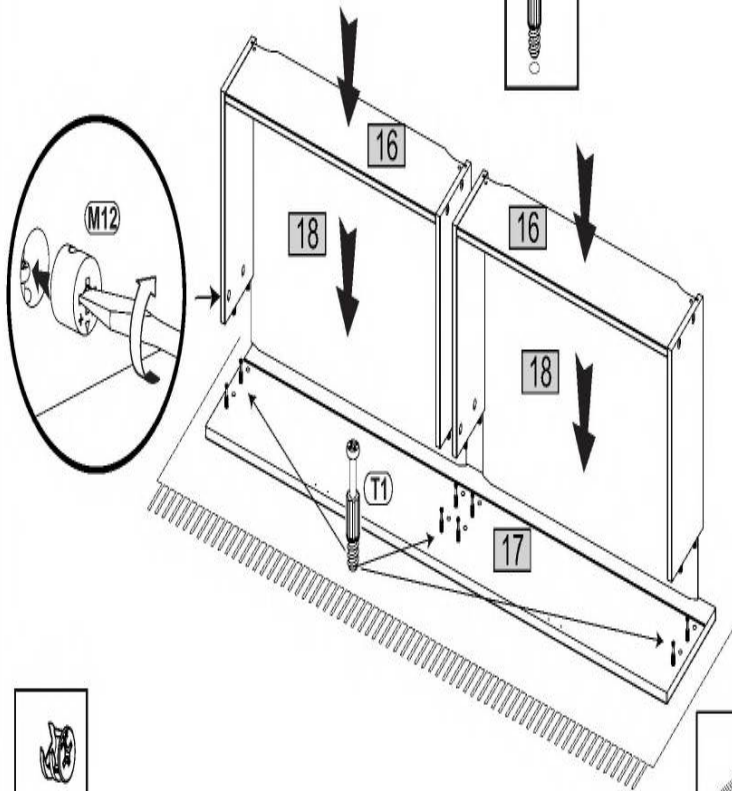
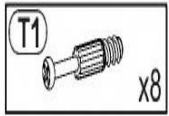

4

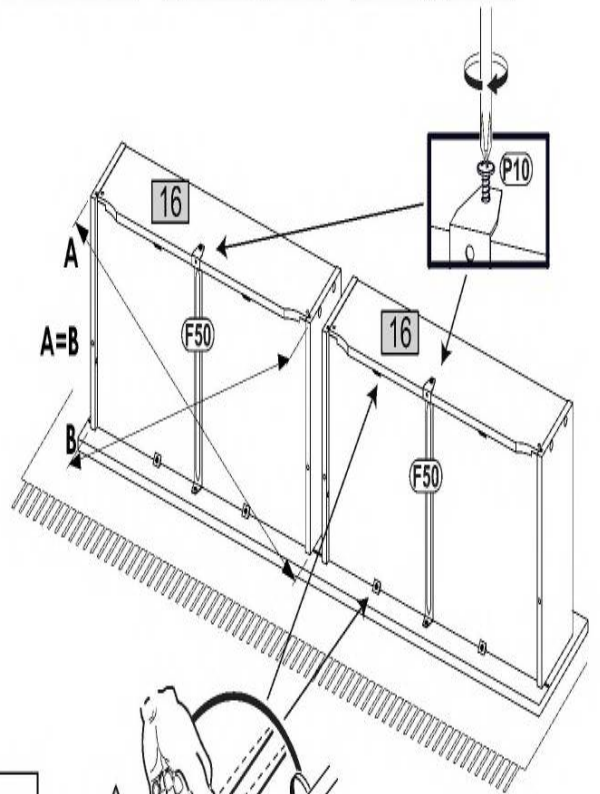
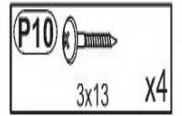
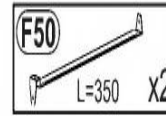

5

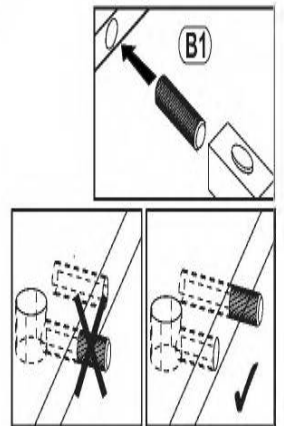
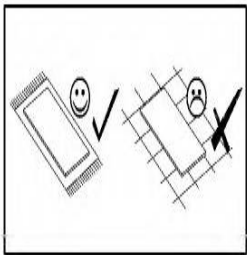
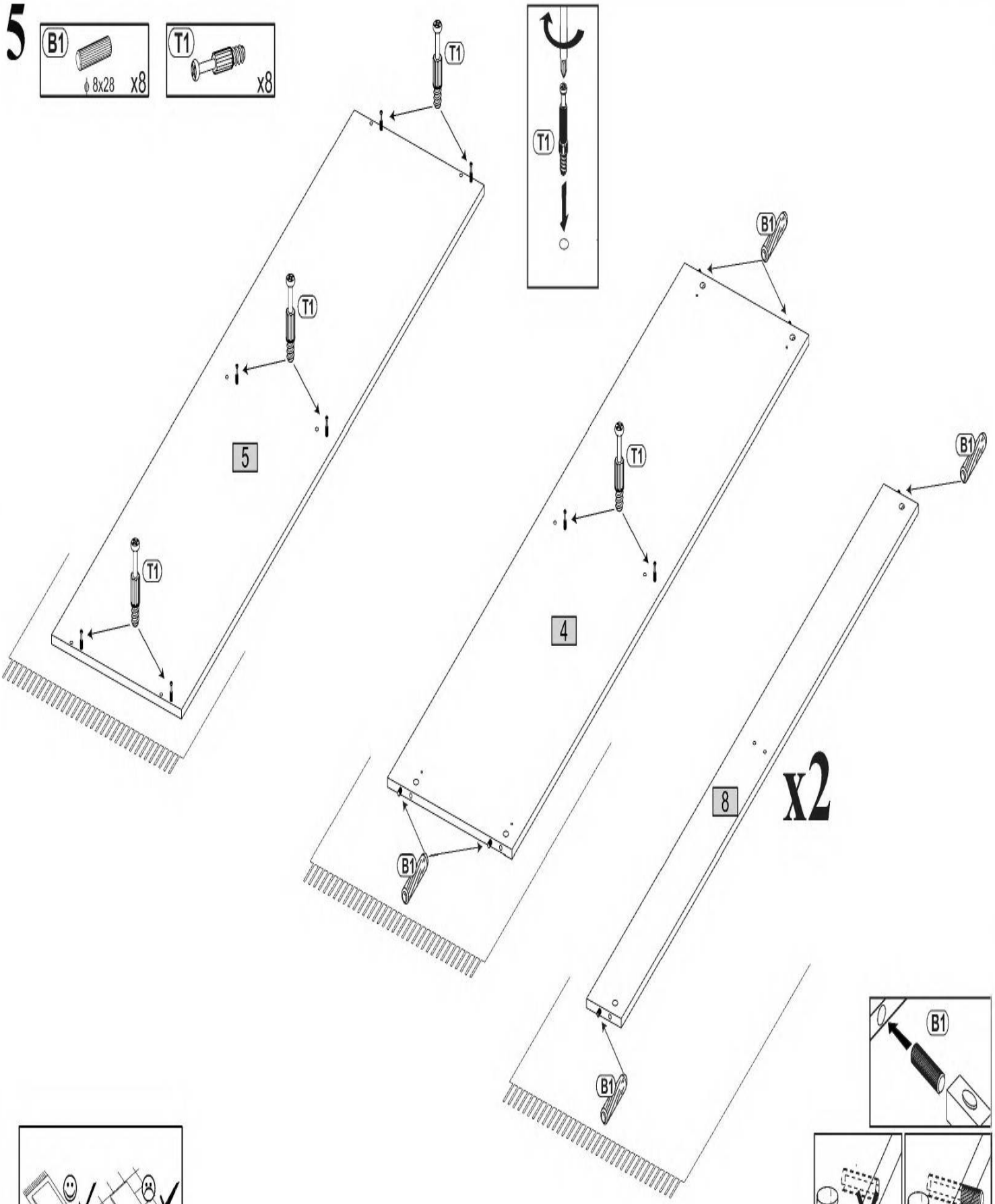
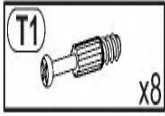
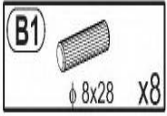

6

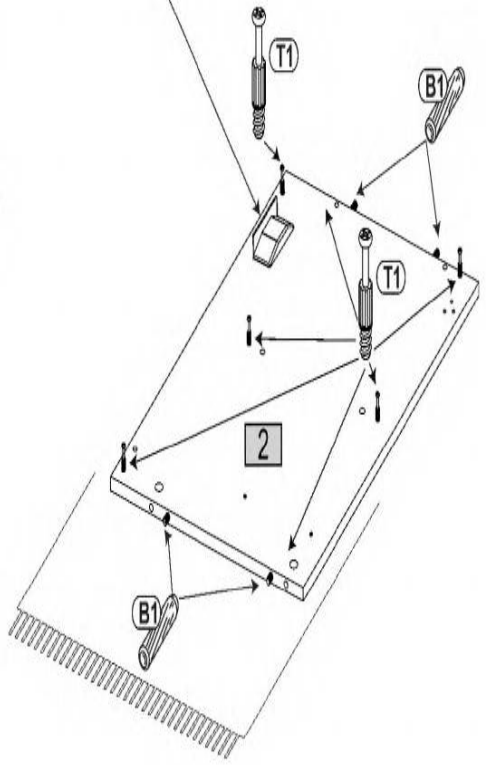
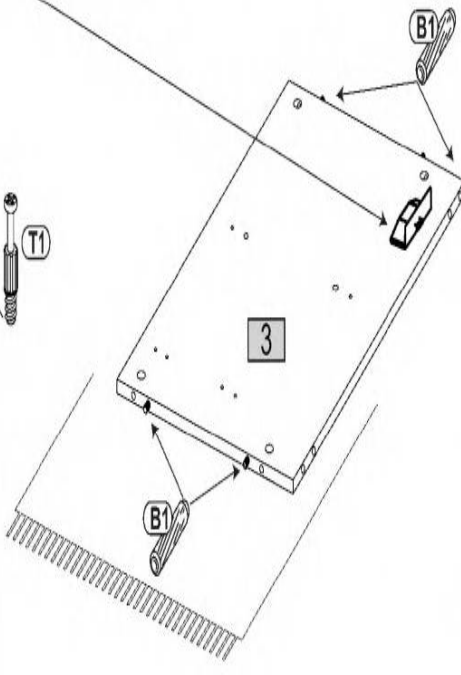
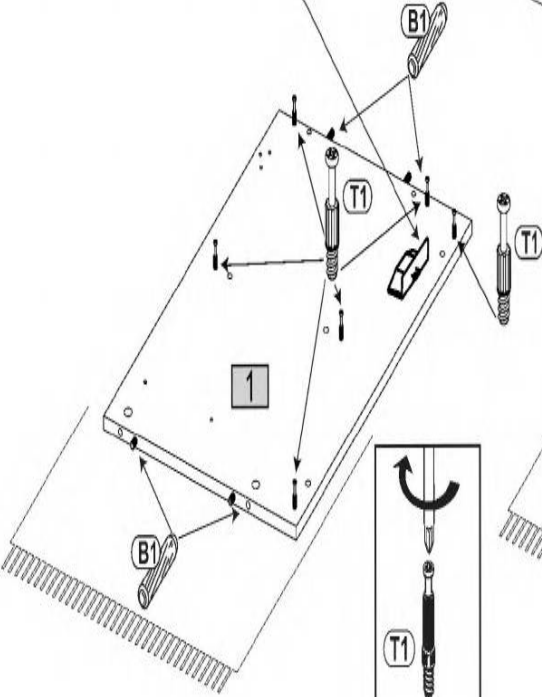
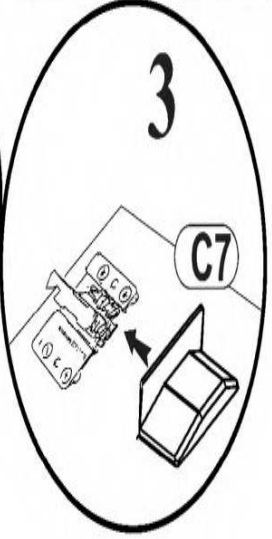
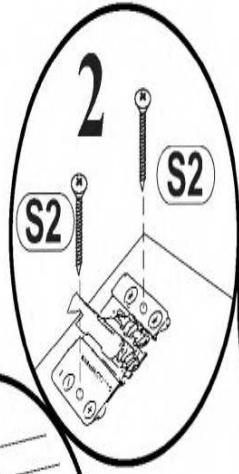
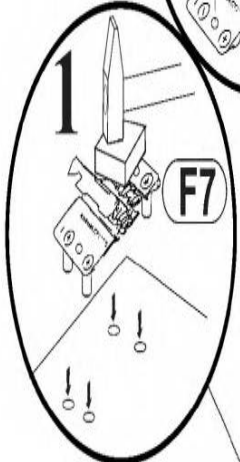
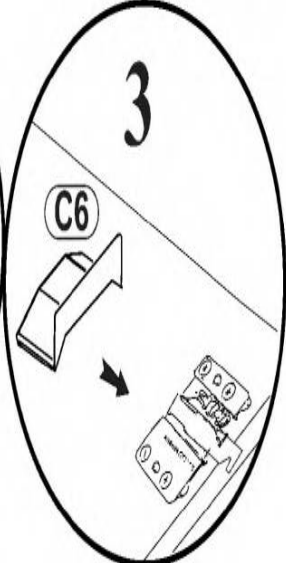
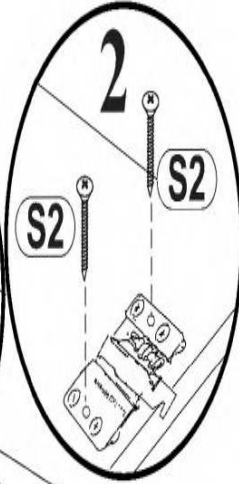
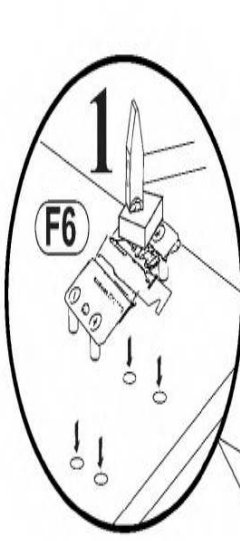
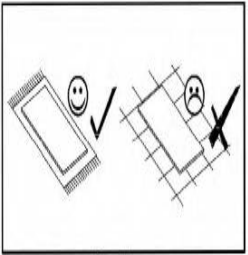
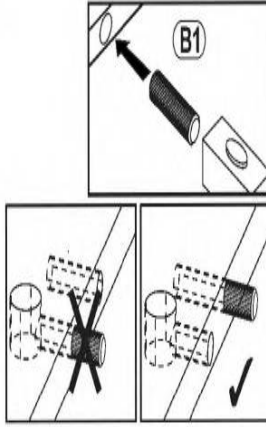
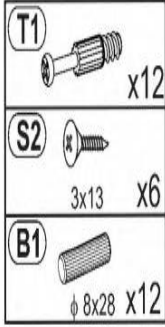
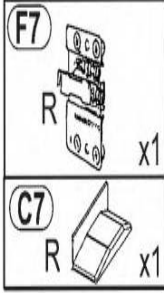
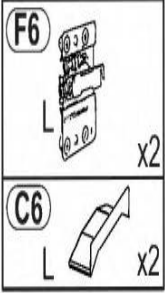

7

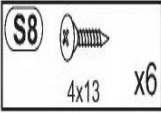
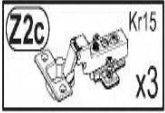

8

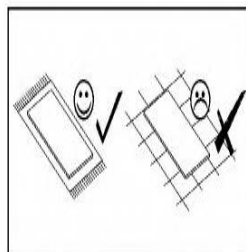
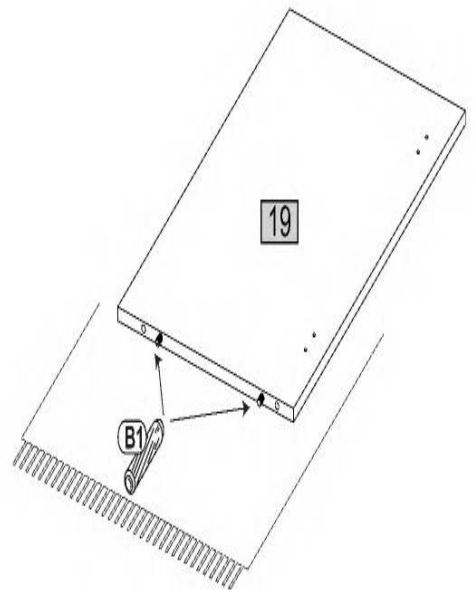
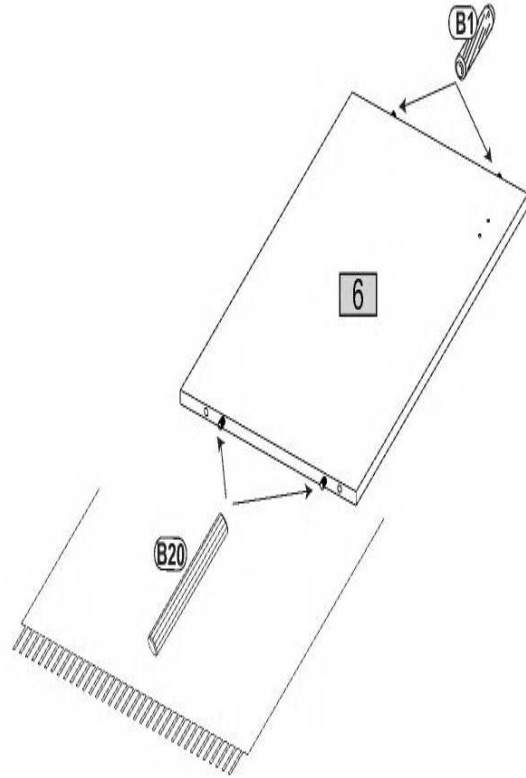
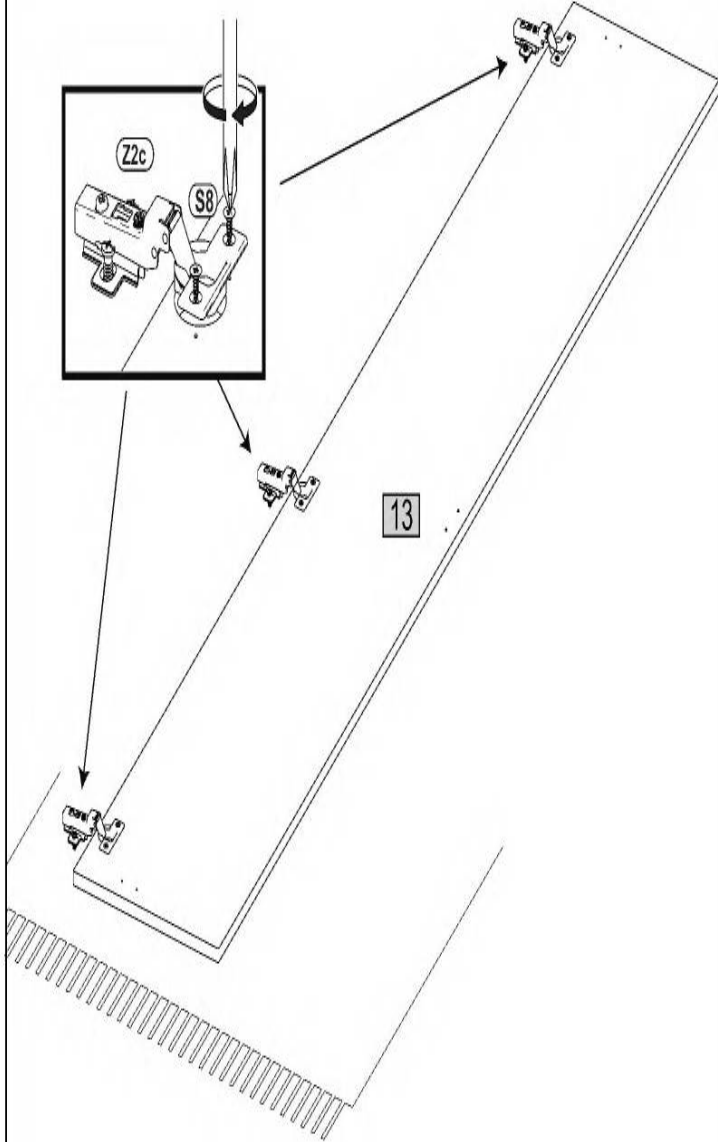
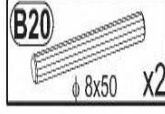
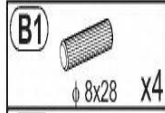

9

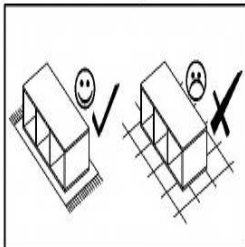
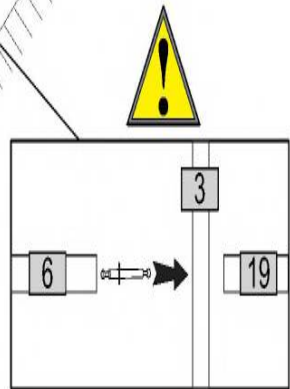
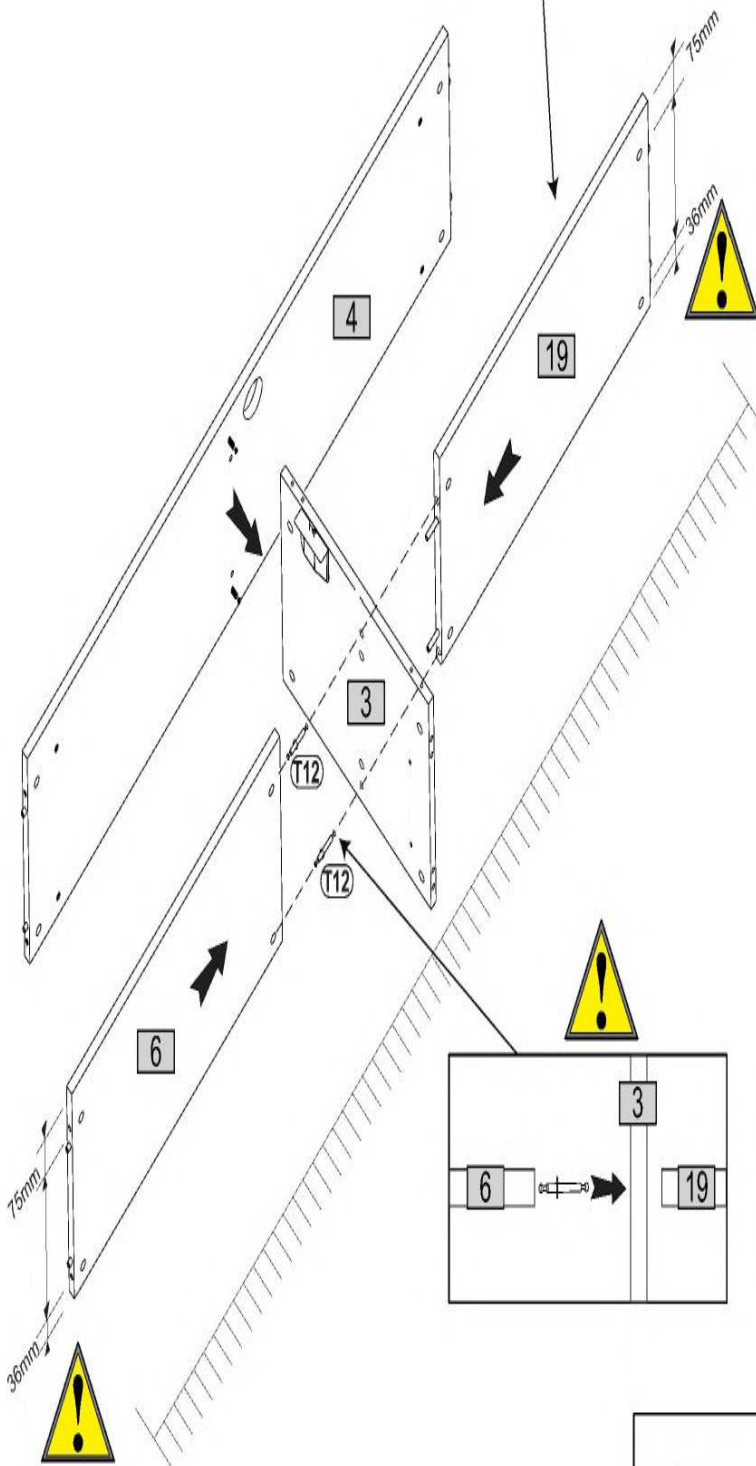
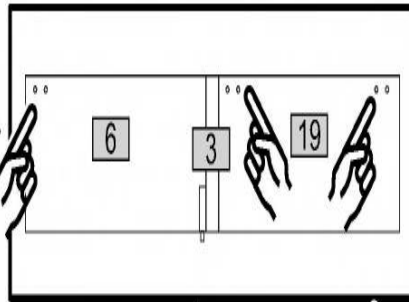
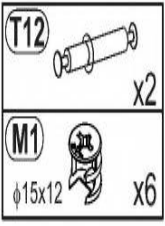

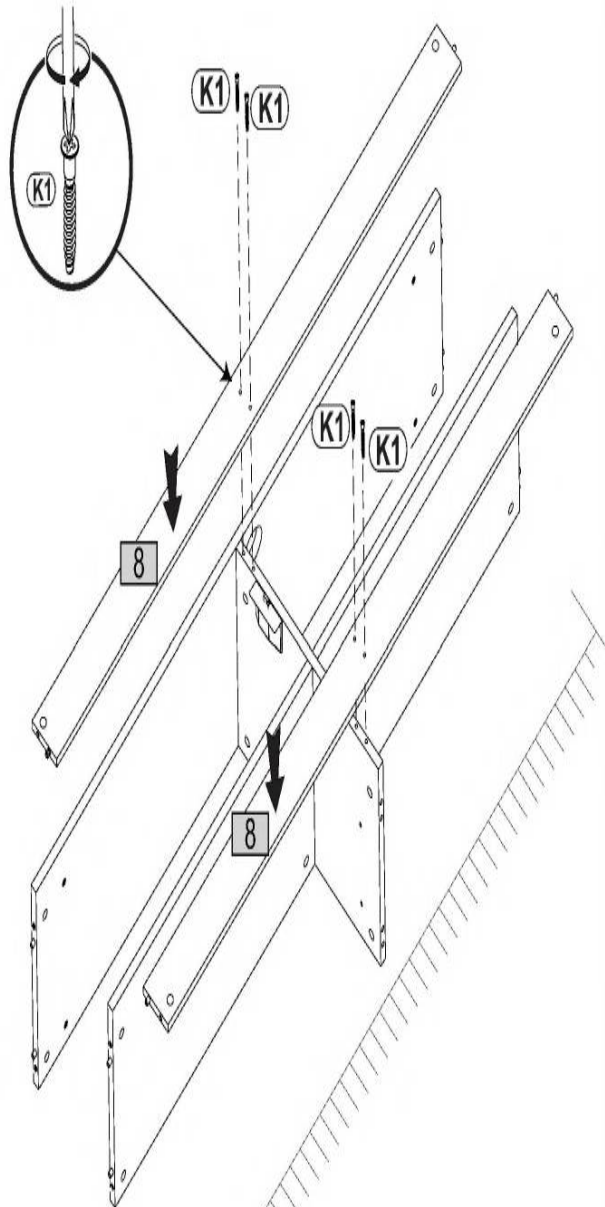
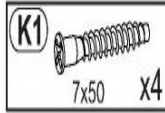

10

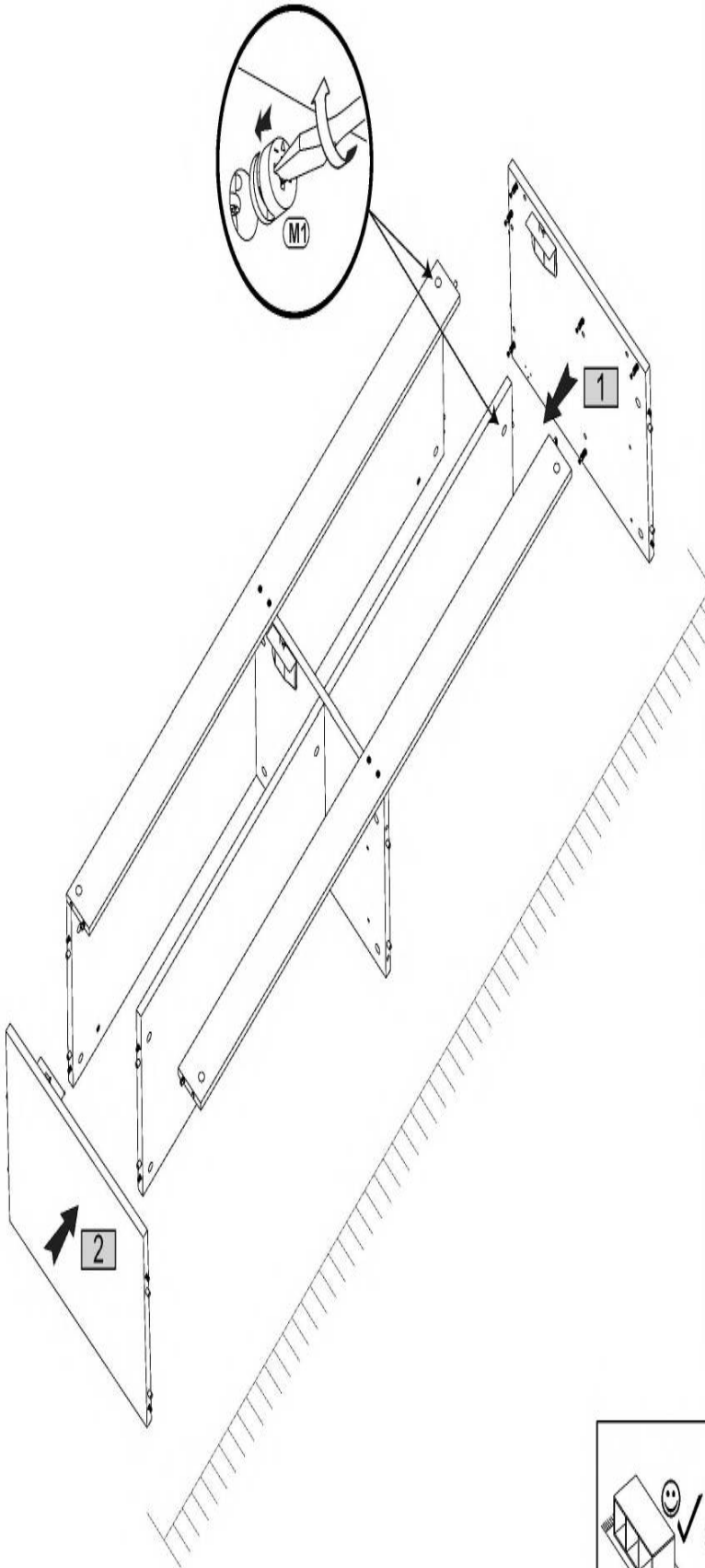

11  $\phi 15 \times 12$  x12



12  $\phi 15 \times 12$  x6

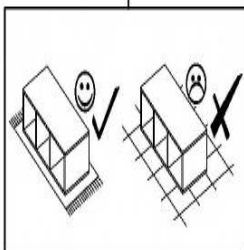
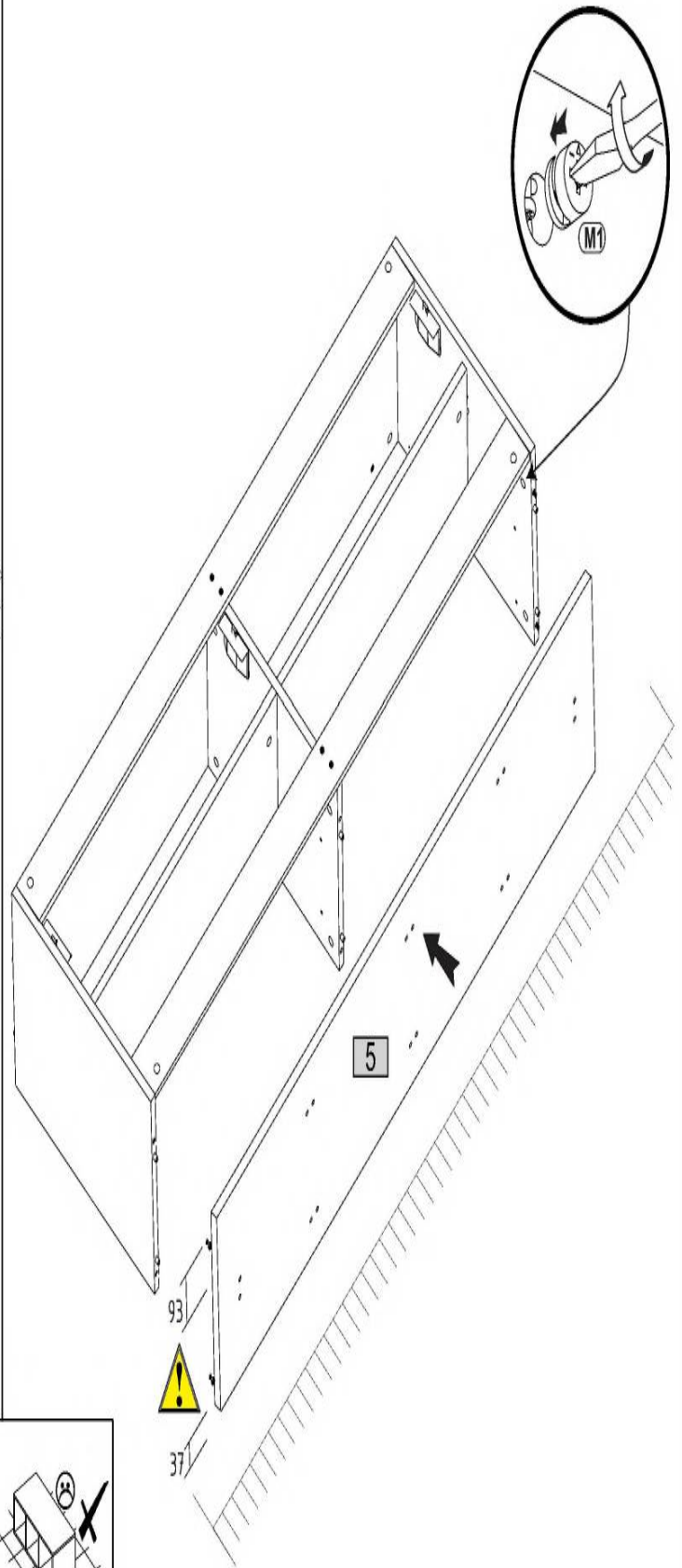

13

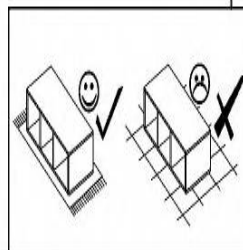
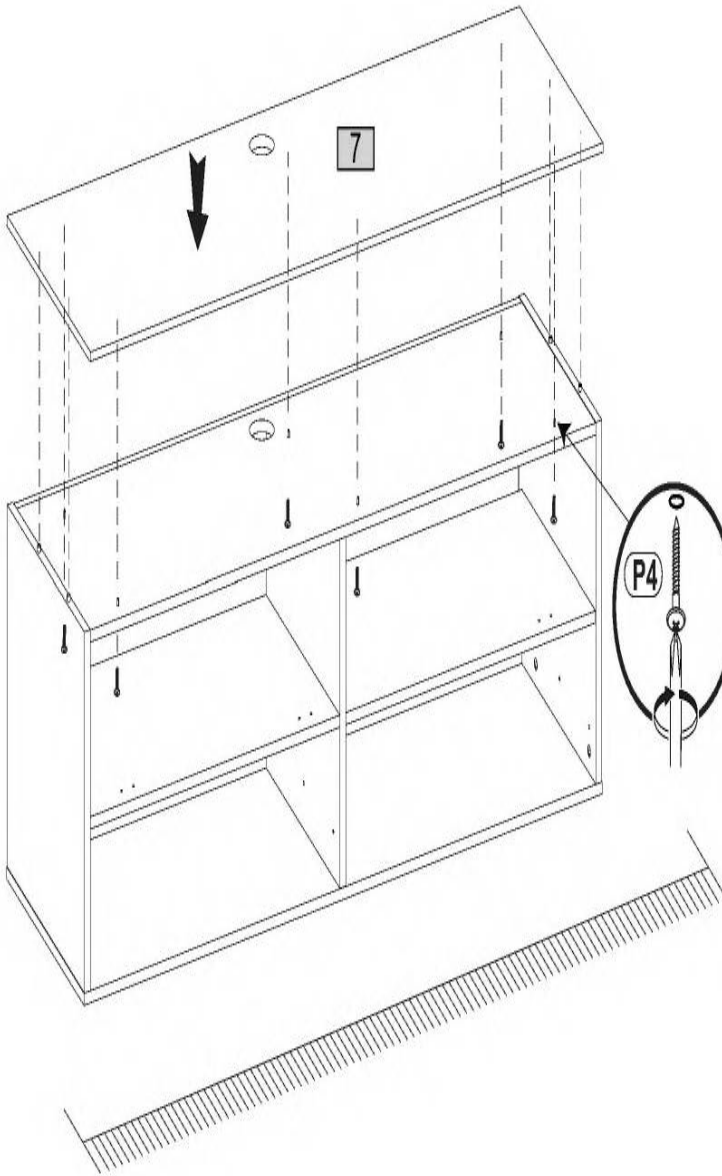
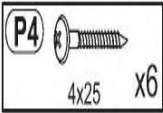

14

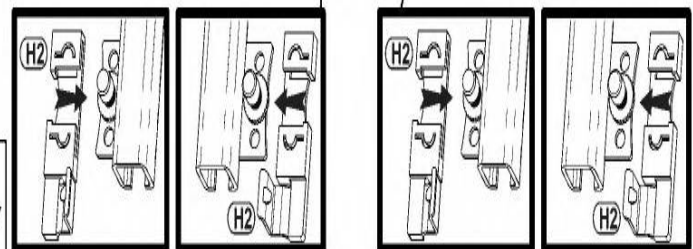
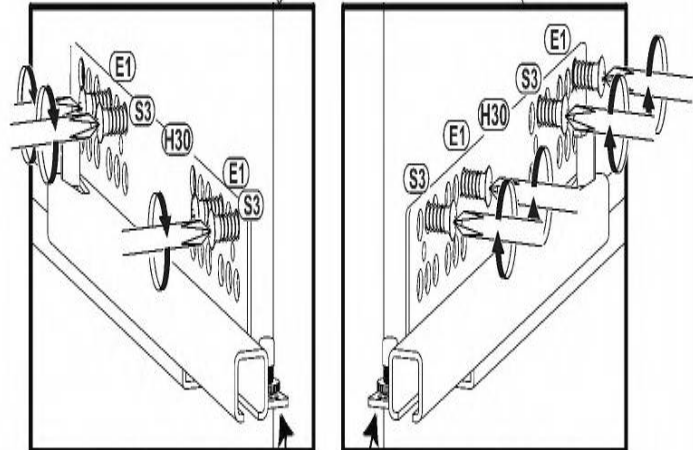
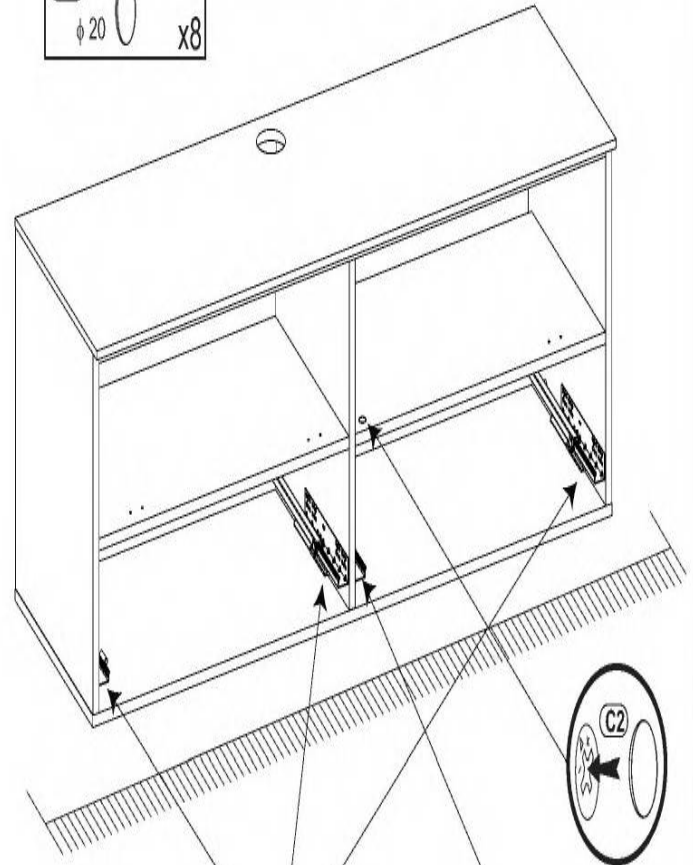
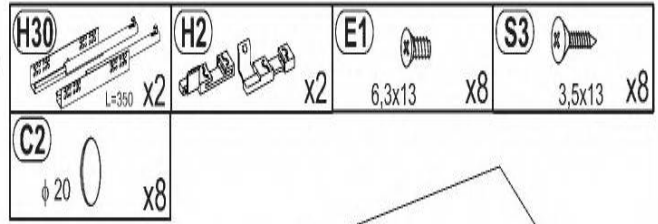

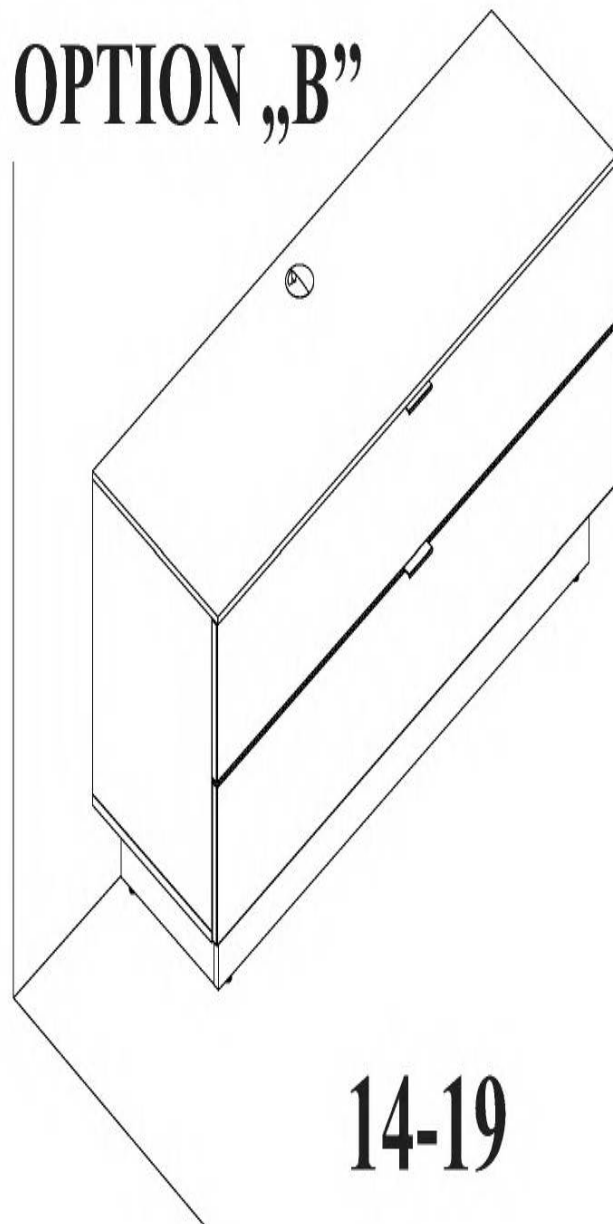
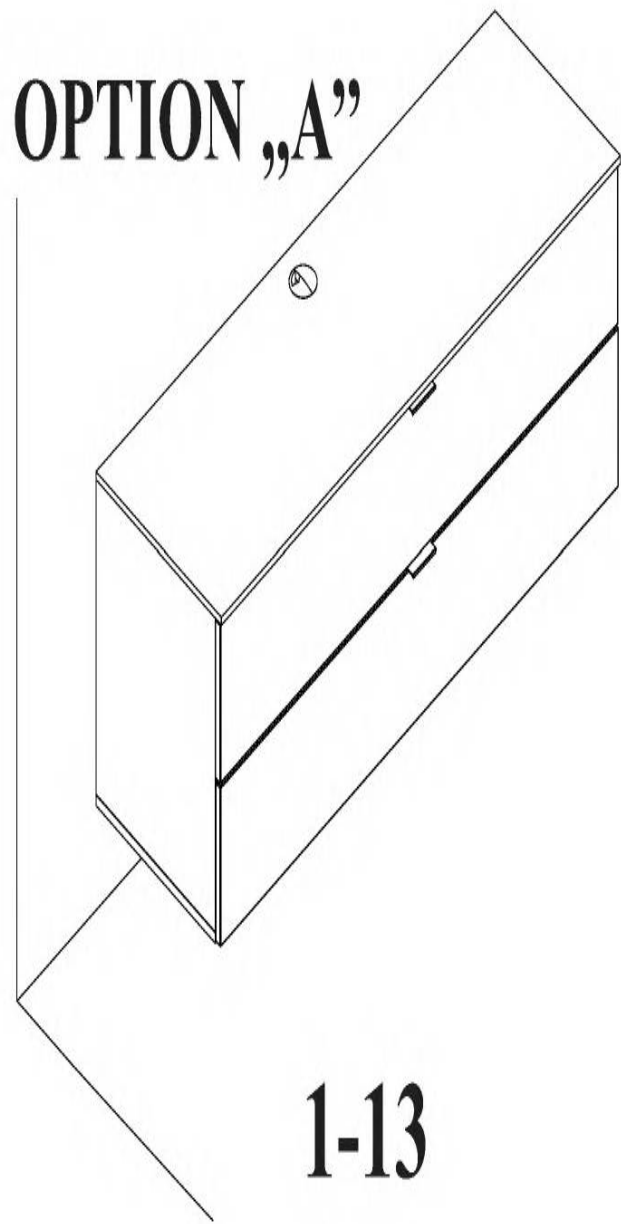

15

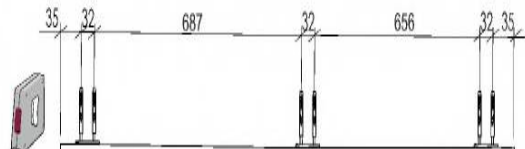
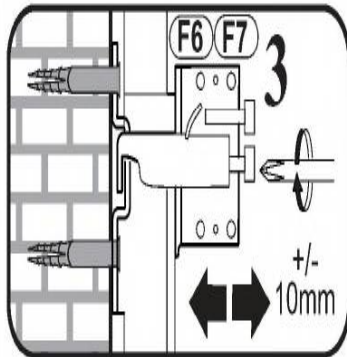
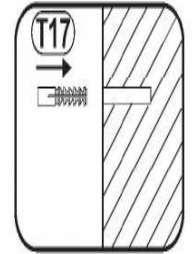
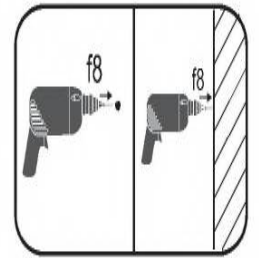
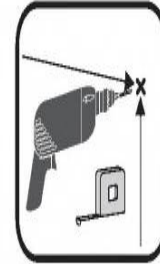
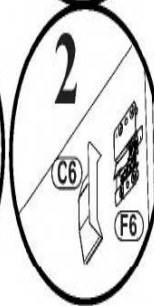
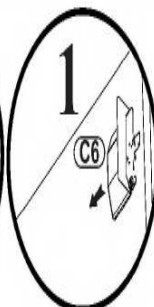
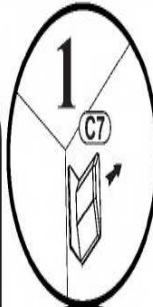
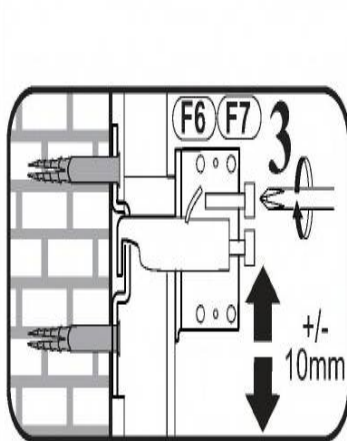
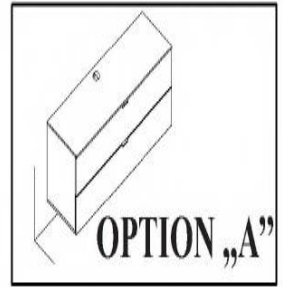
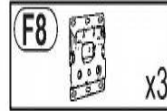
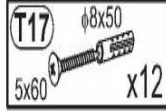

OPTION „A”

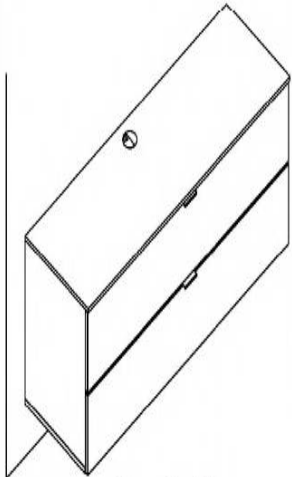

1-13

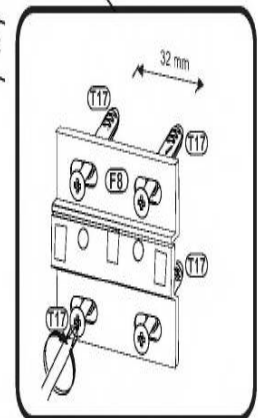
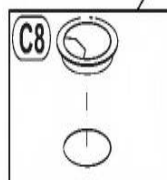
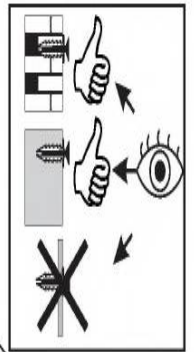
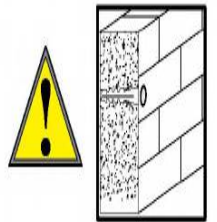
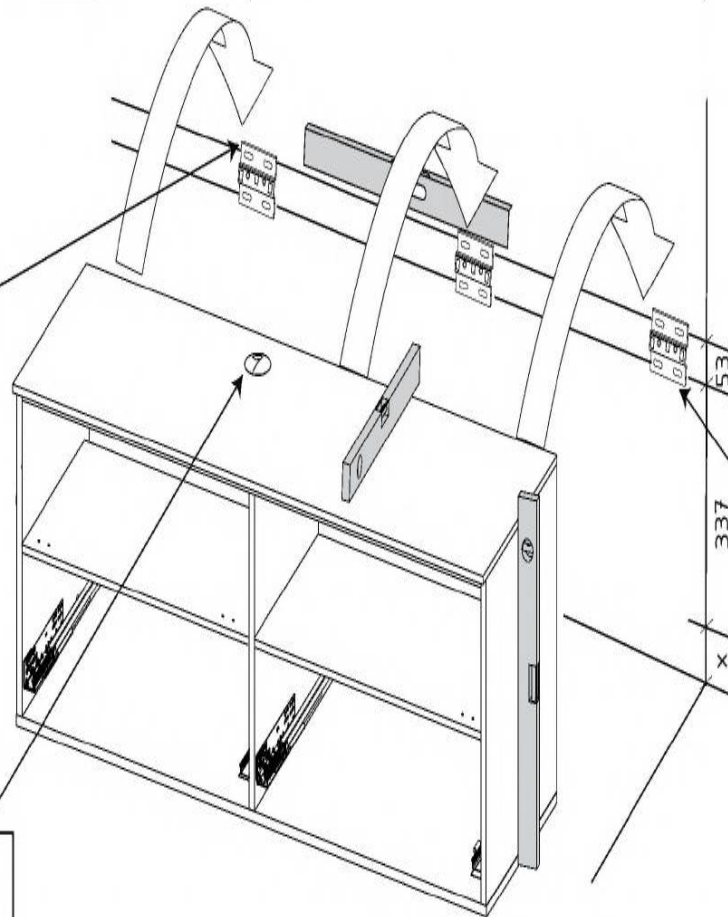
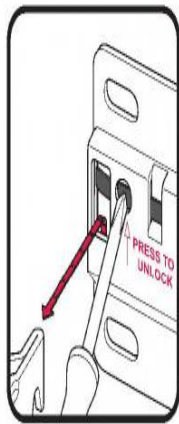

16

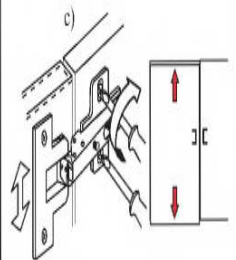
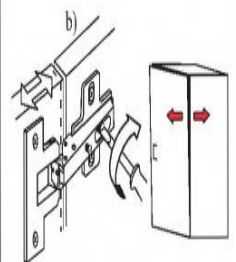
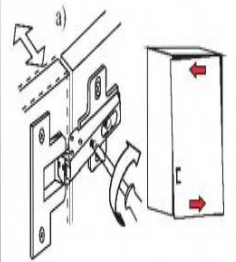
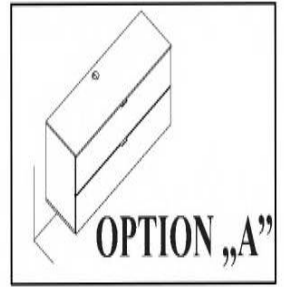
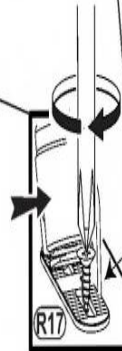
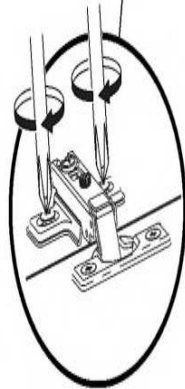
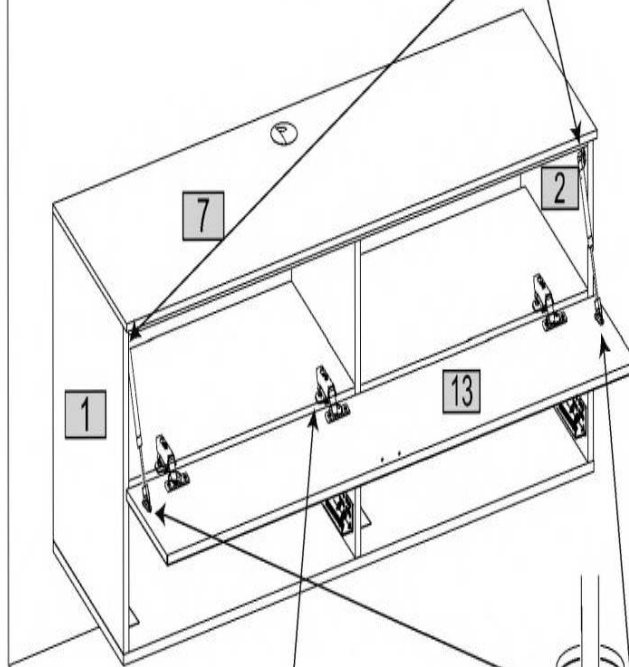
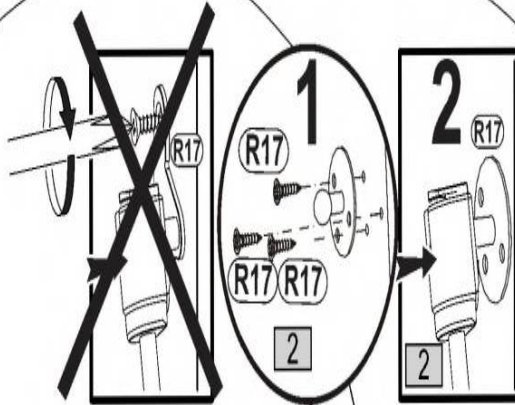
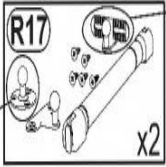

17

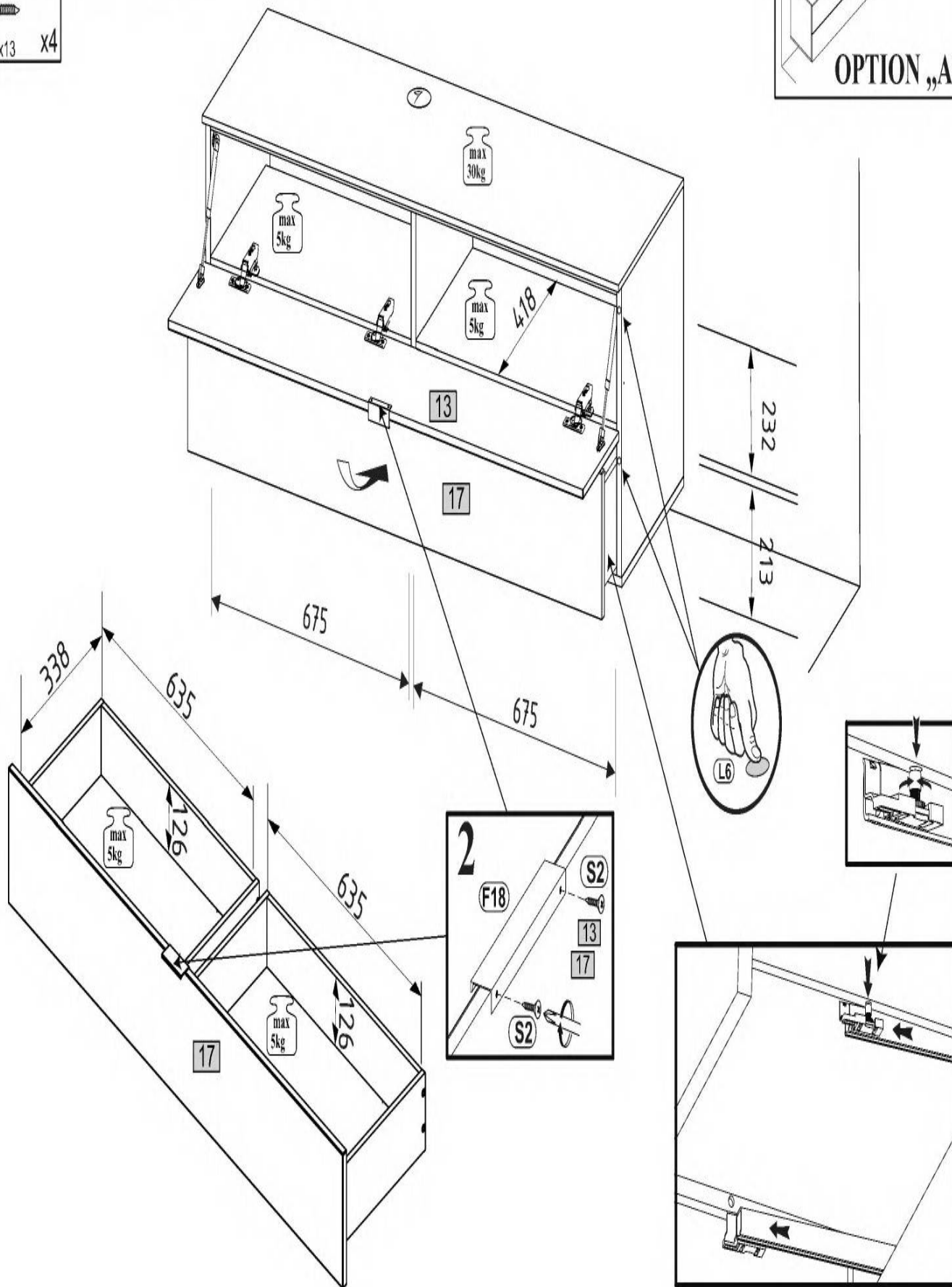
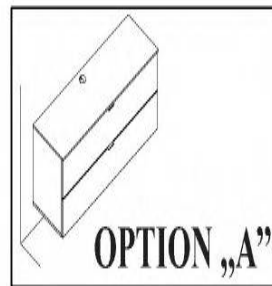
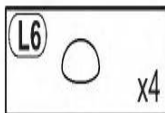
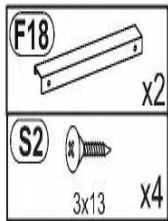

OPTION „B”

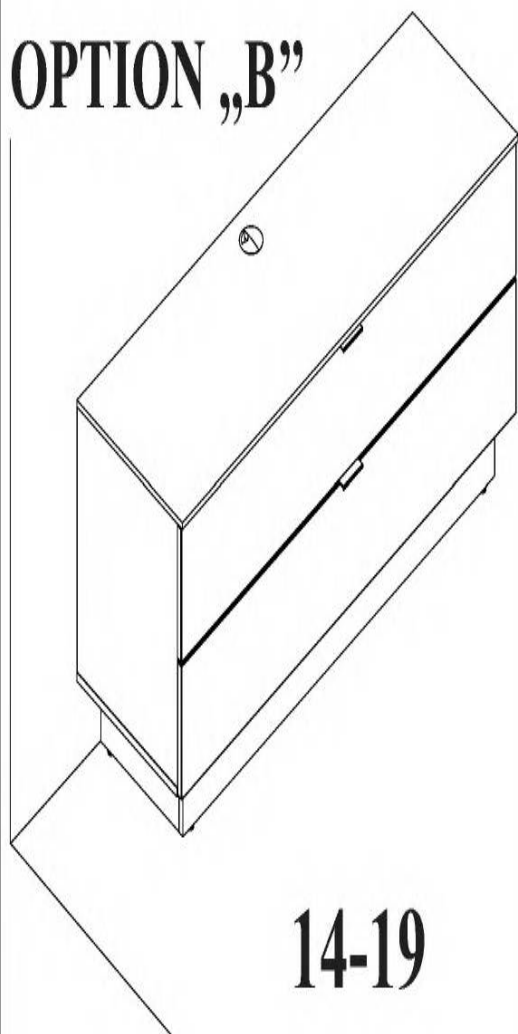

14-19

18

- F4** x4
- G18** x4
- F7** x1
- L21** x8
- P13** 3,5x13 X16

- B1** ϕ 8x28 x4

- T1** x4

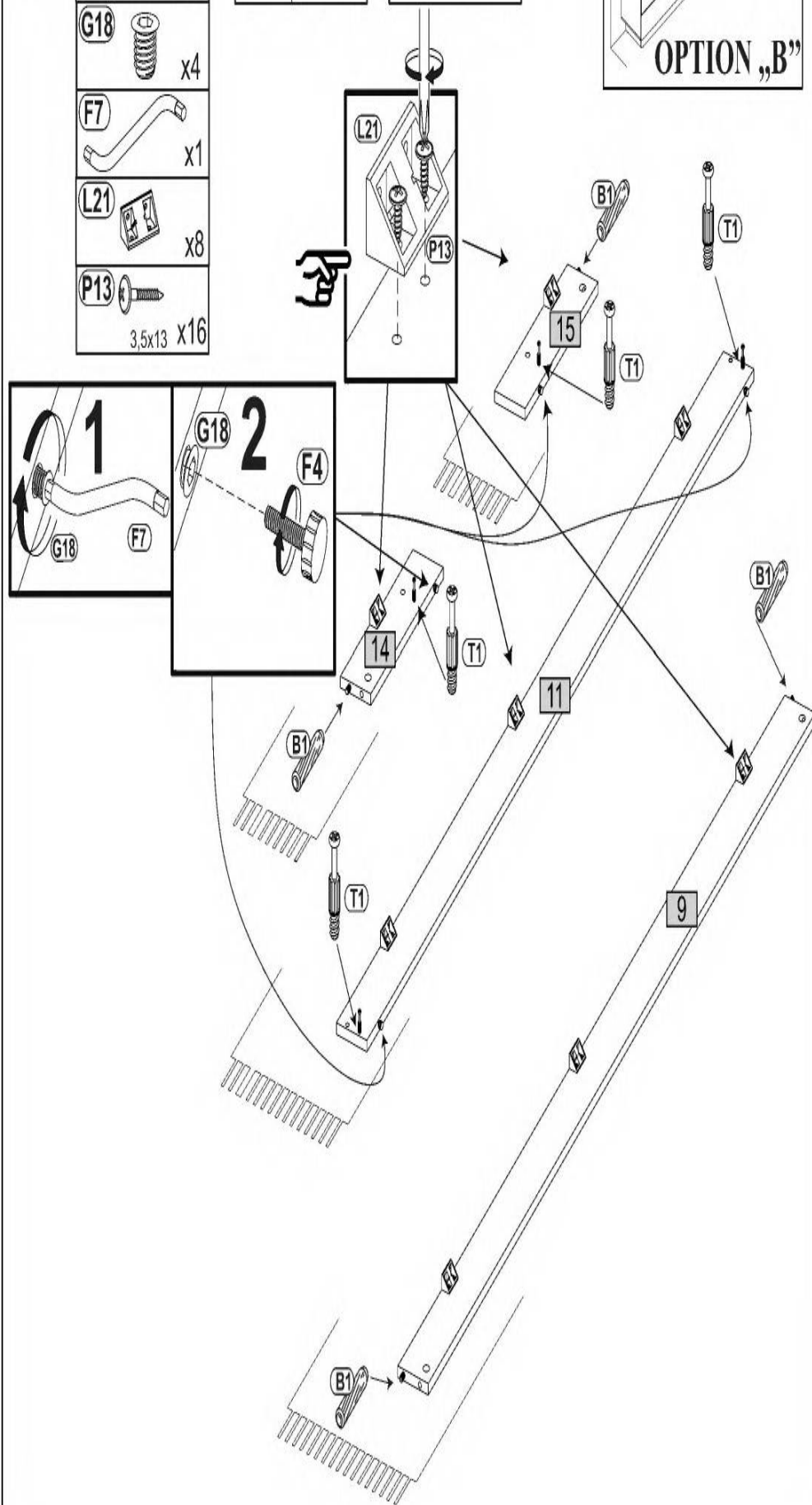
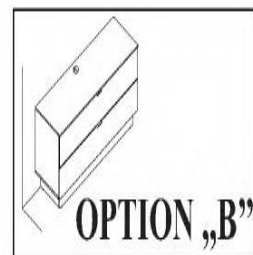

19

M1
φ15x12
x2

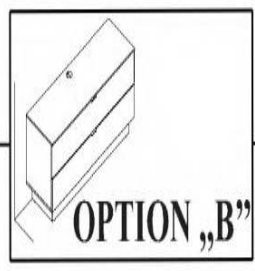
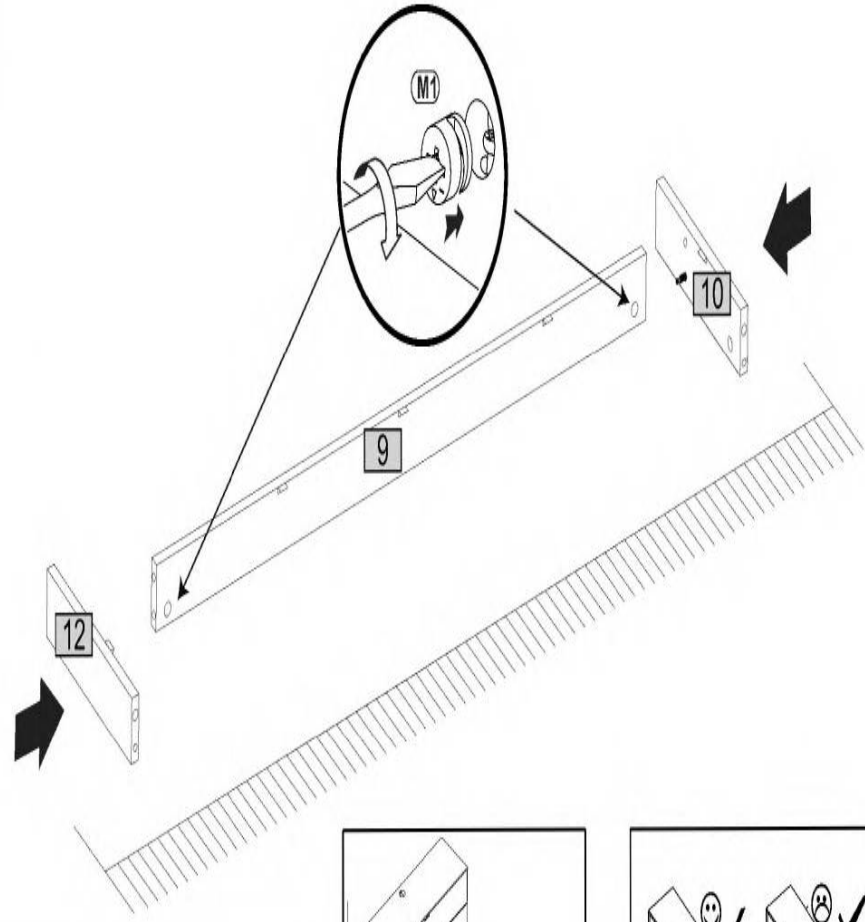

20

M1
φ15x12
x2

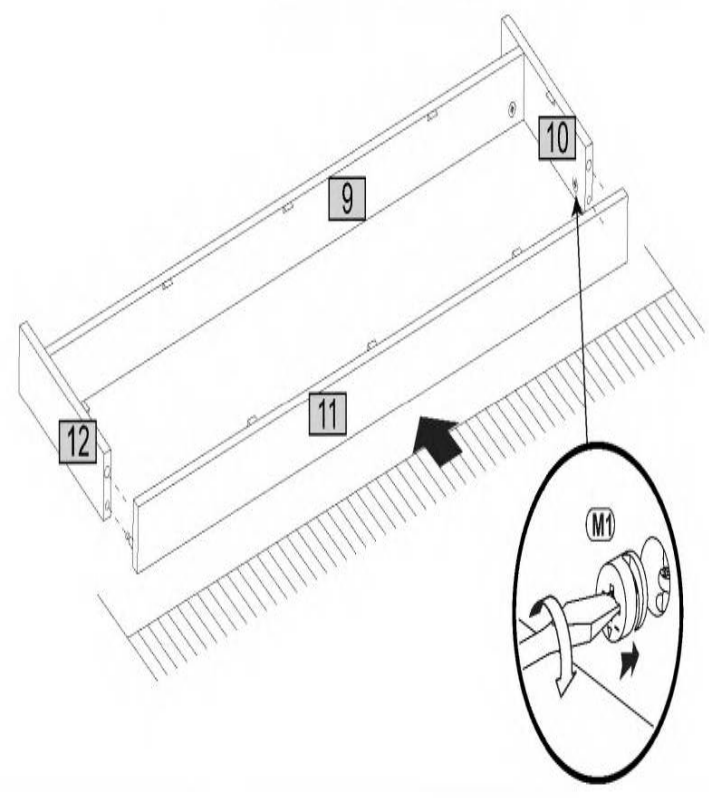

21

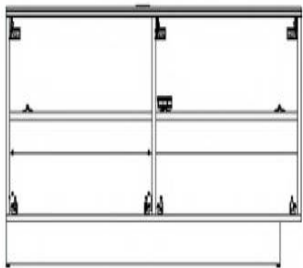
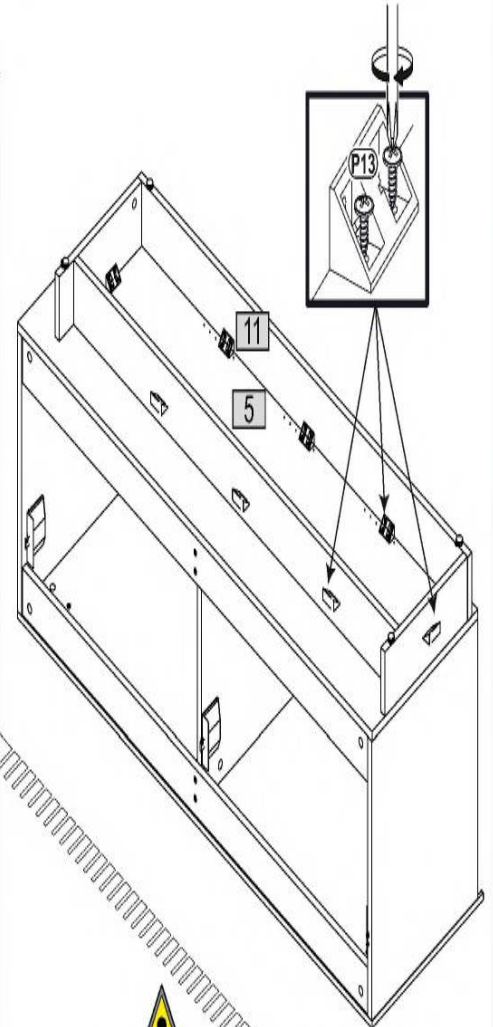
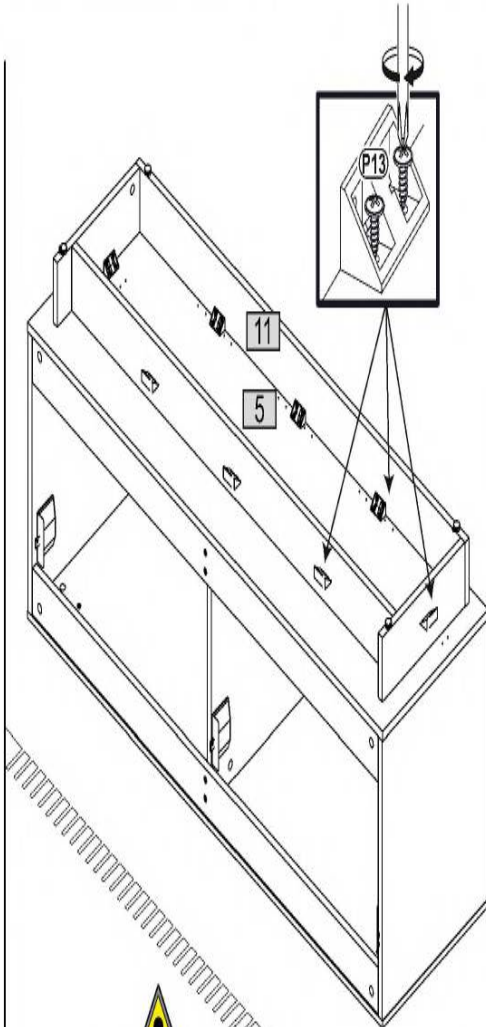
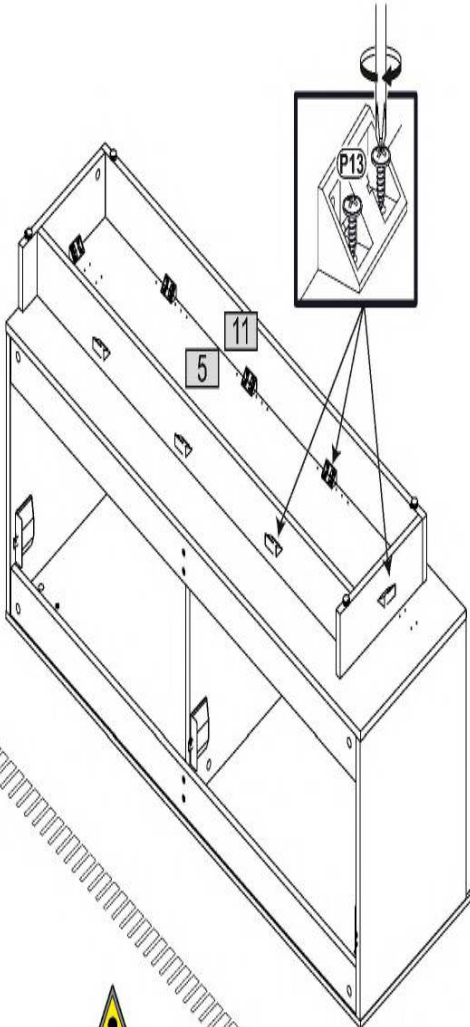
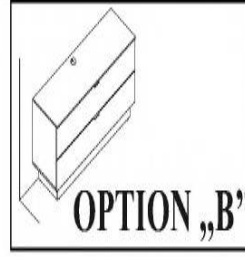
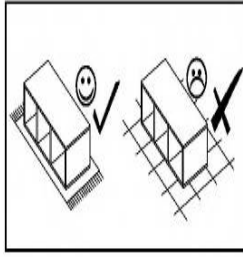
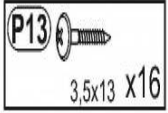

B1

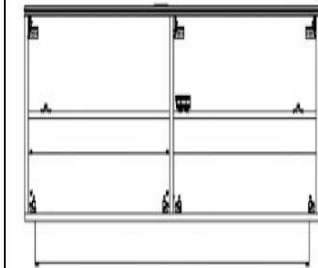
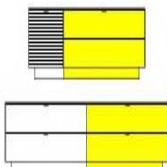

B2

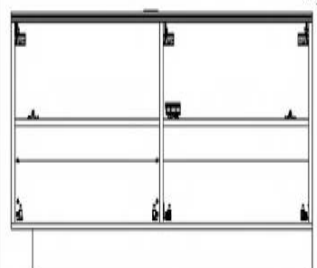
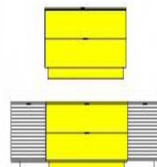
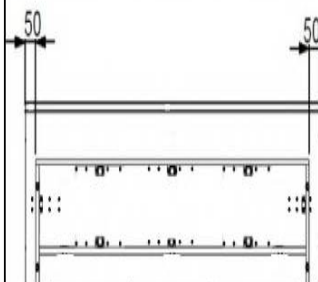

B3

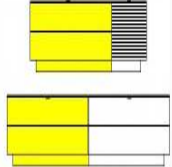
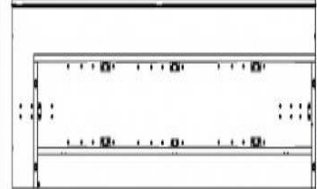

21

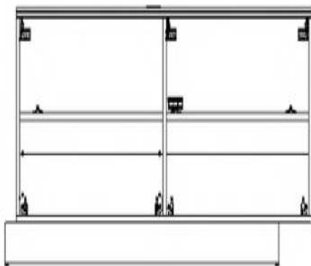
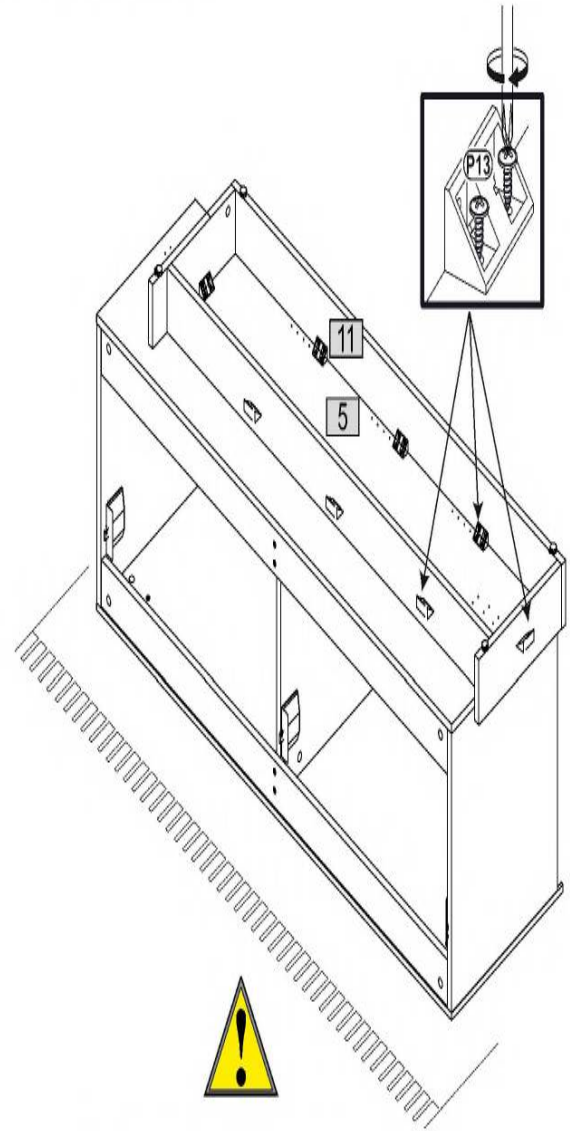
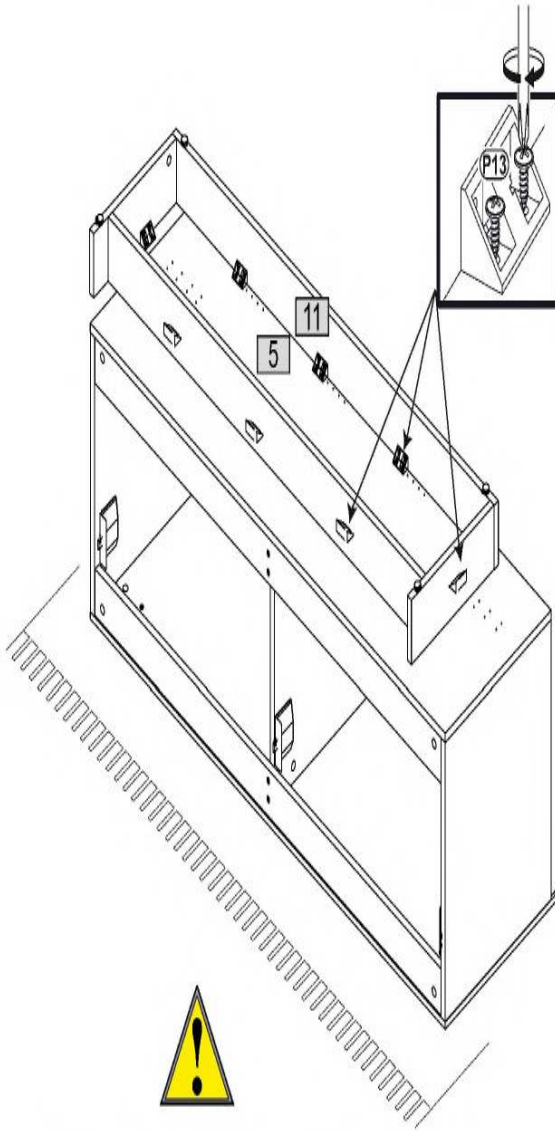
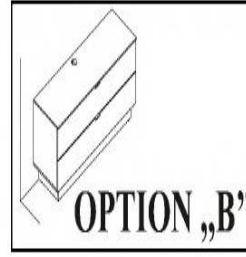
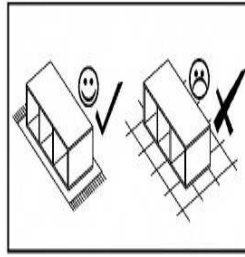
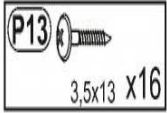

B4

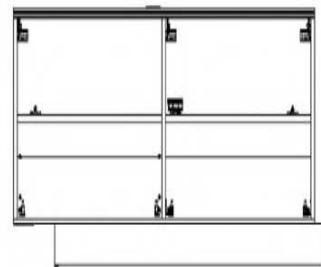
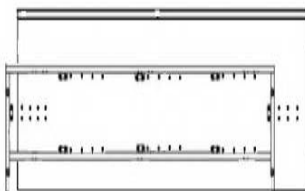

B5

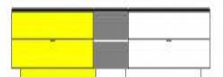
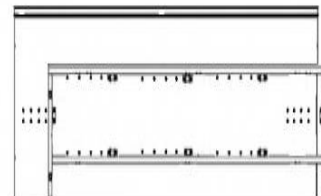

22

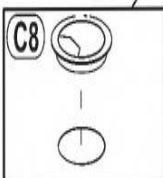
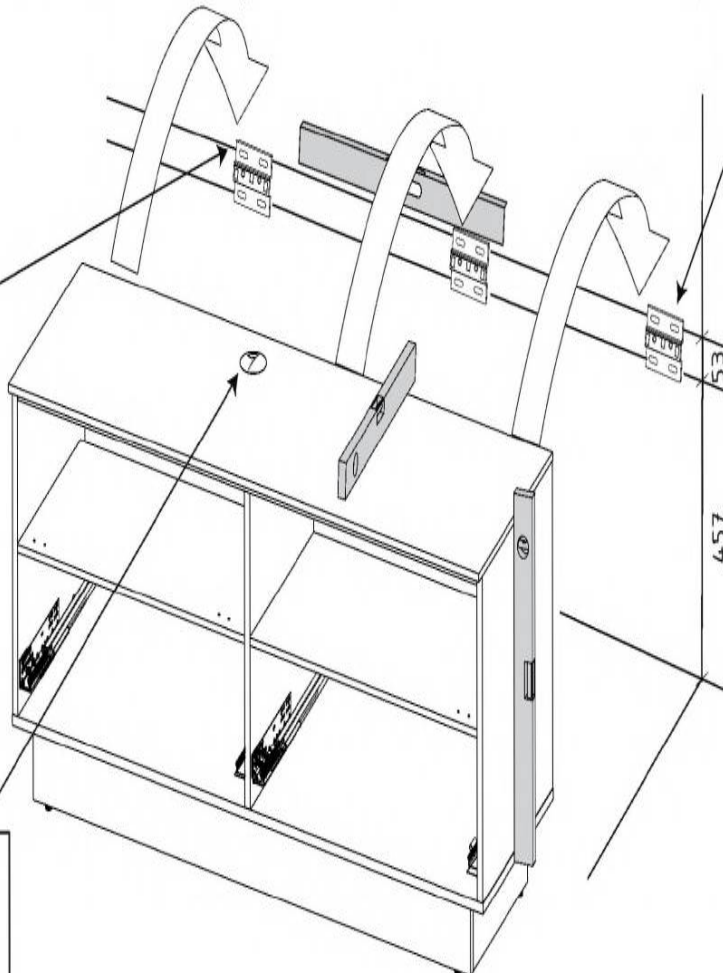
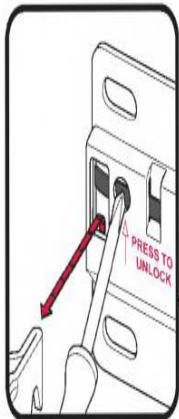
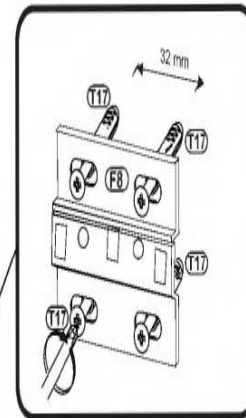
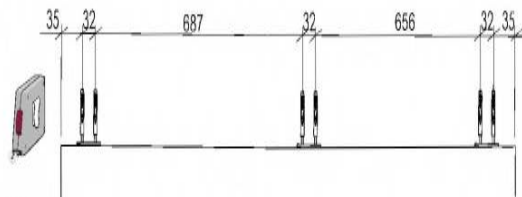
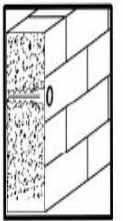
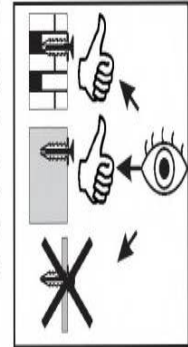
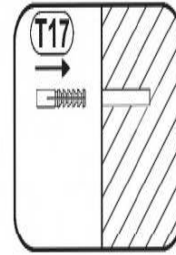
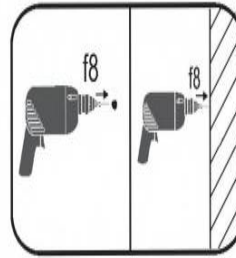
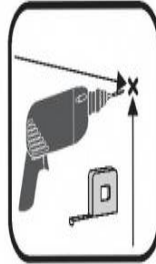
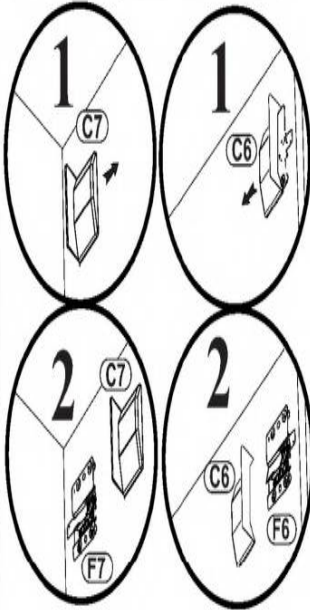
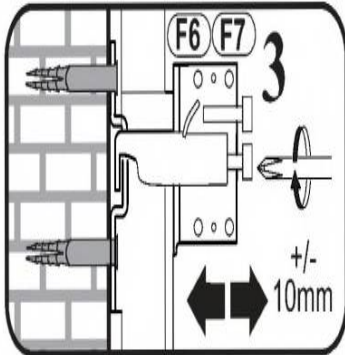
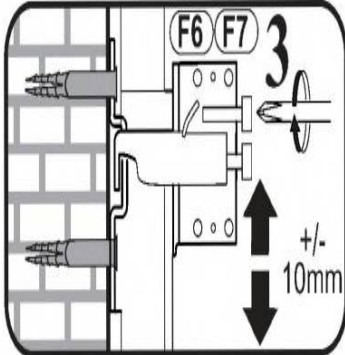

23

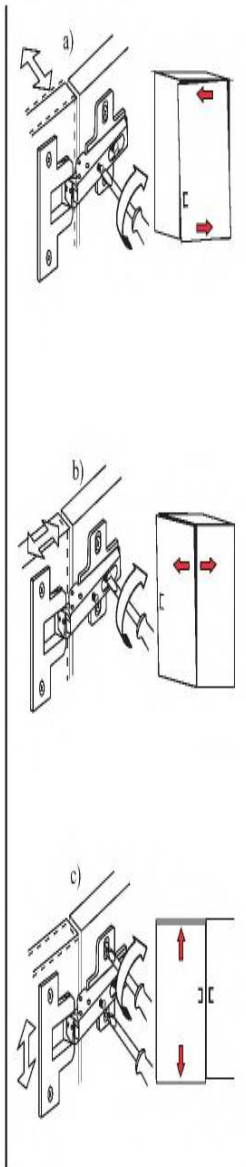
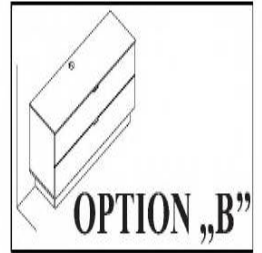
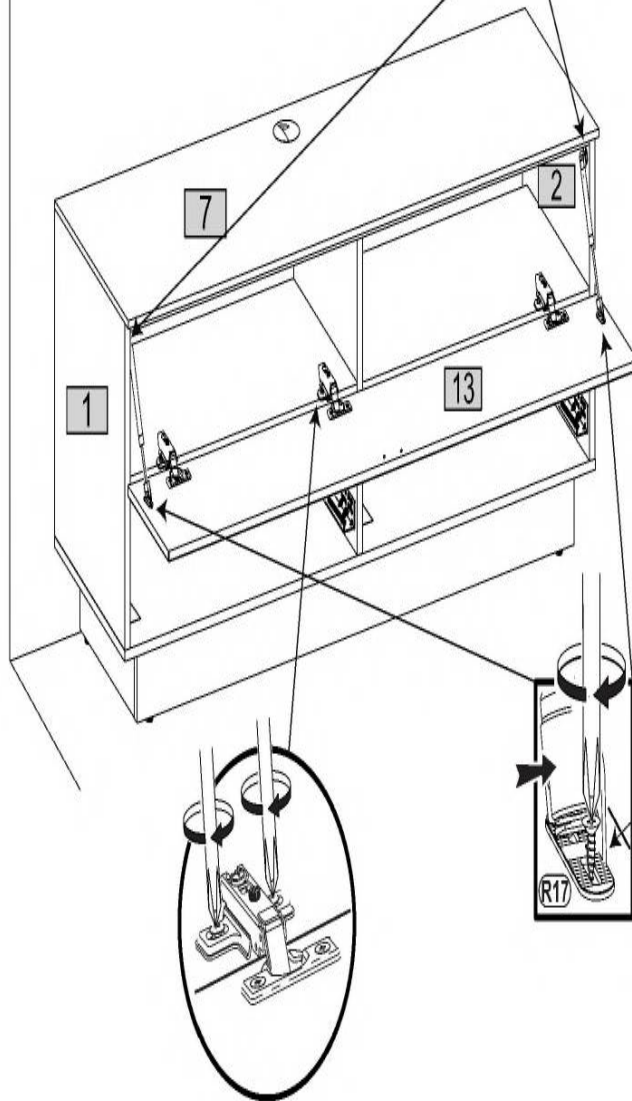
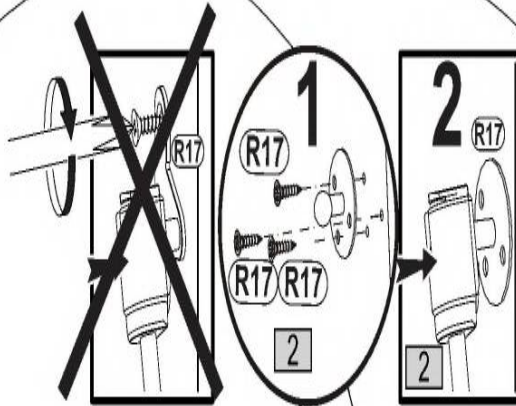
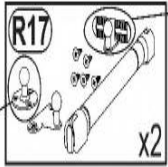

24

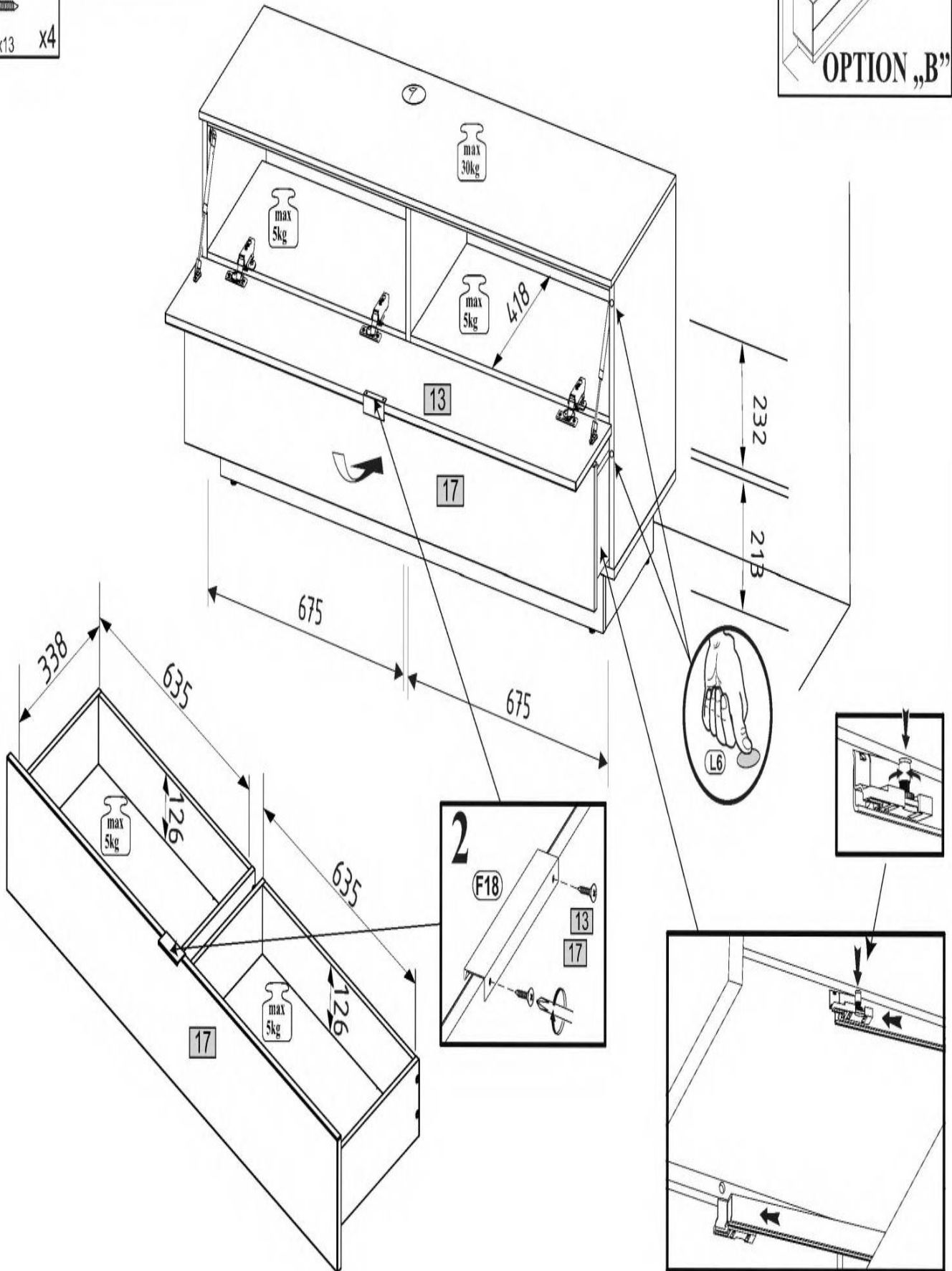
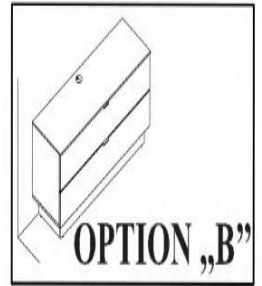
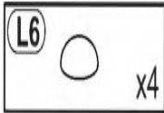
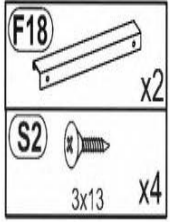

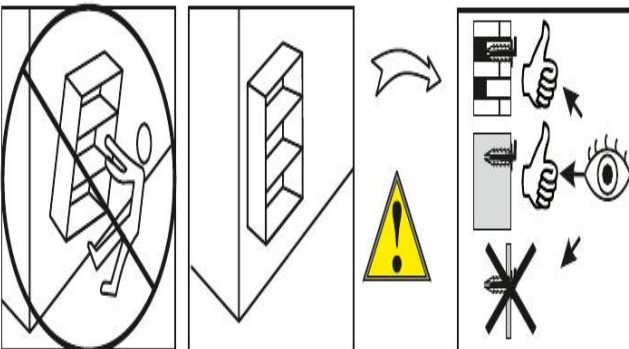
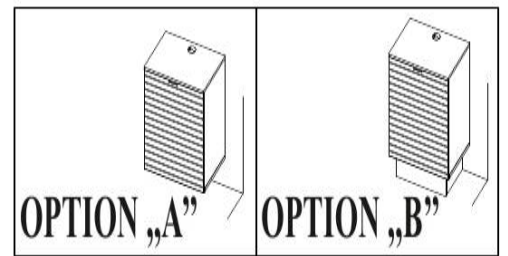
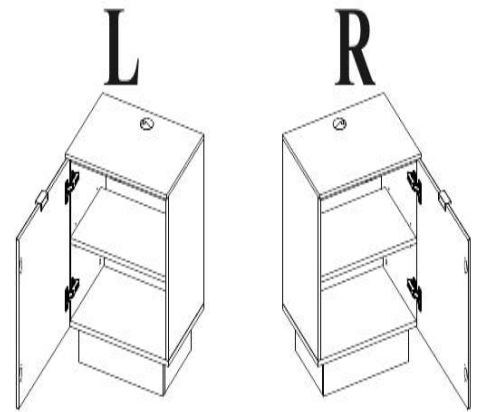
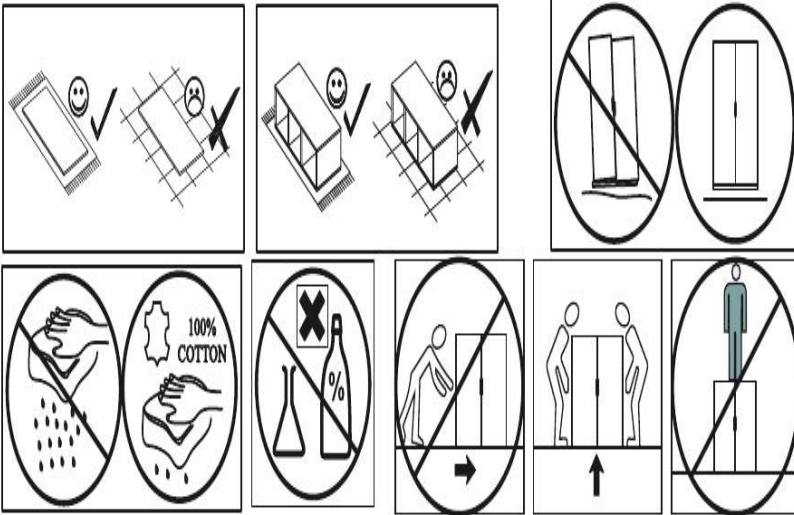
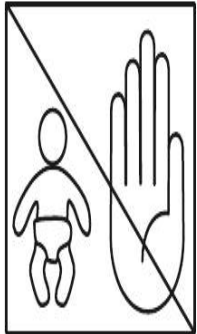
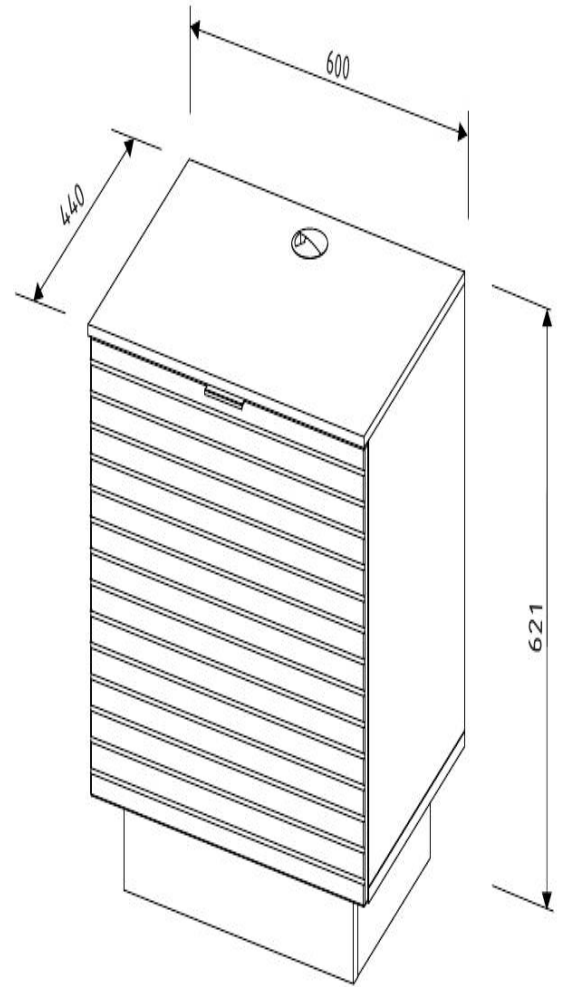
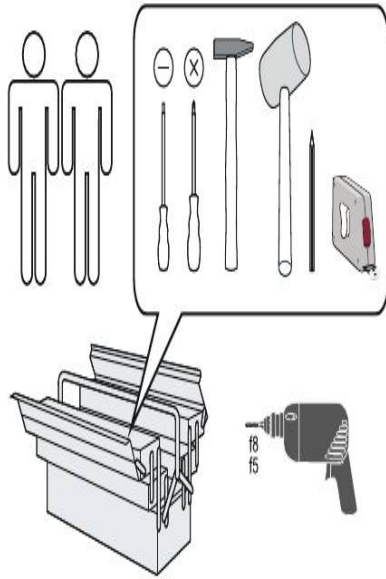

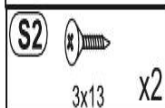
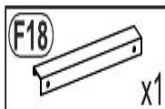
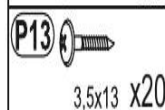
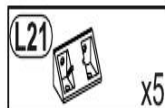
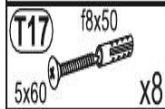
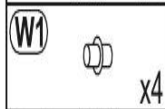
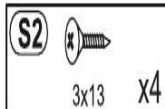
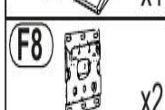
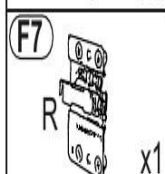
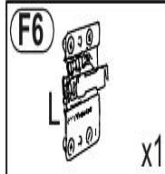
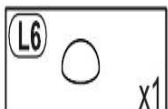
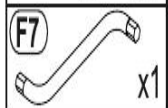
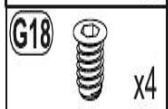
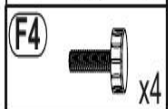
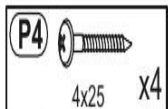
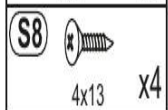
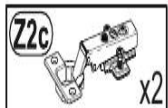
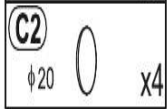
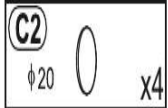
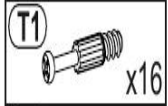
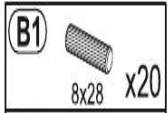

Nr	↙	↘	↗	pcs	☐
1	477	418	16	1	1
2	477	418	16	1	1
3	566	399	16	1	1
4	600	418	16	1	1
5	566	367	16	1	1
6	600	440	12	1	1
7	500	110	16	1	1
8	326	110	16	1	1
9	326	110	16	1	1
10	466	110	16	1	1
11	566	80	16	2	1
12	596	488	16	1	1

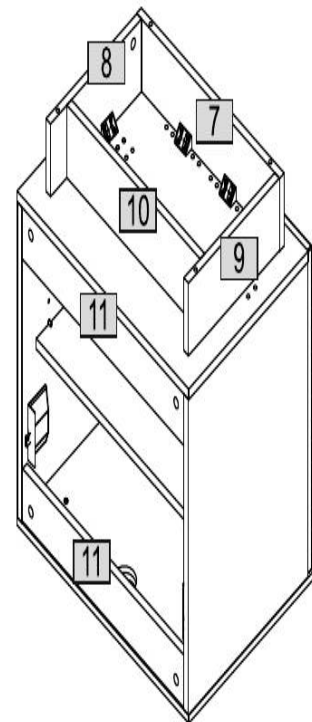
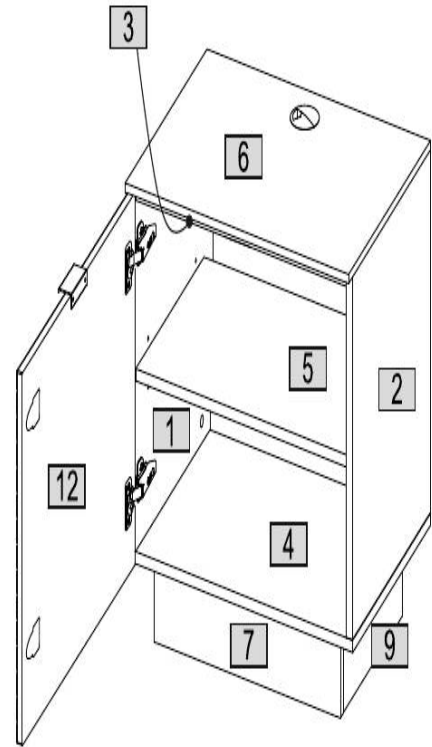

0 10 20 30 40 50 60 70 80 90 100 110 120 130 140 150 160 170 180 190 200

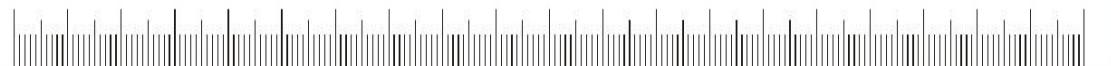

1

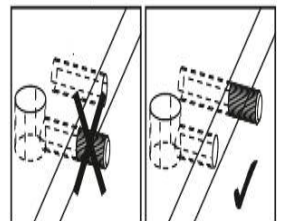
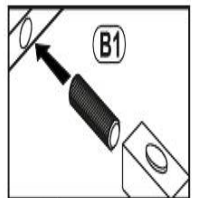
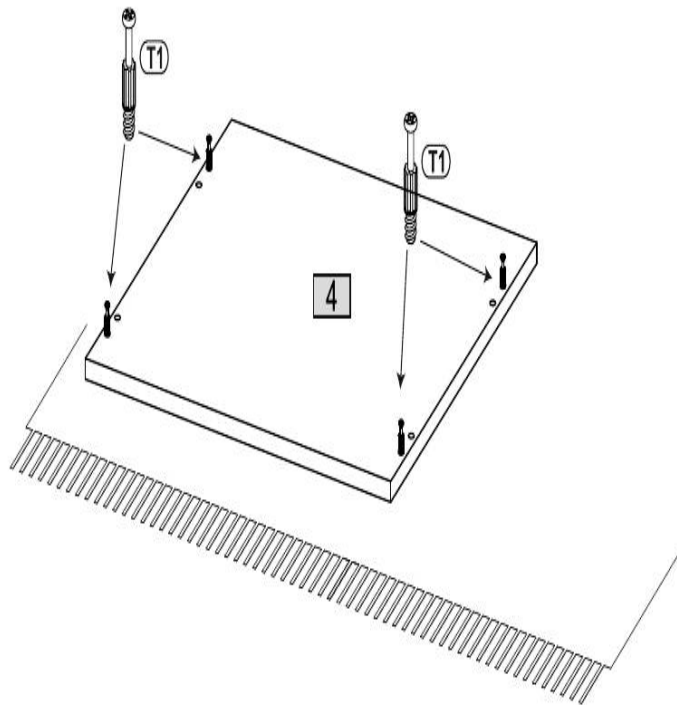
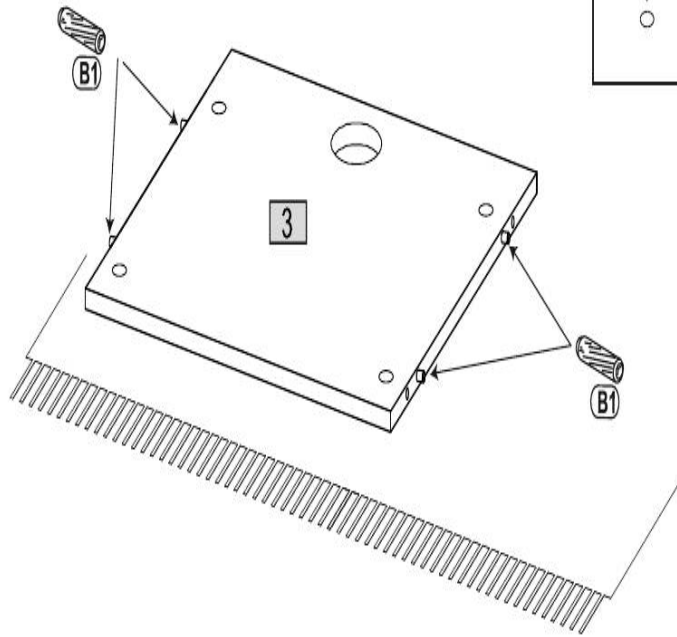
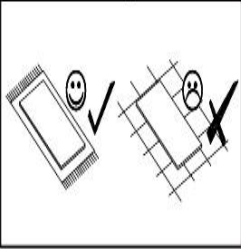
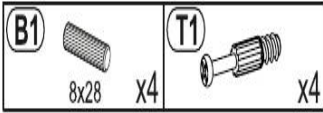

2

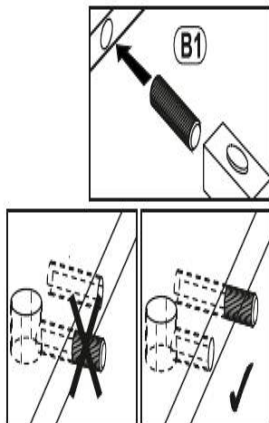
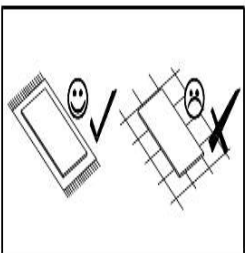
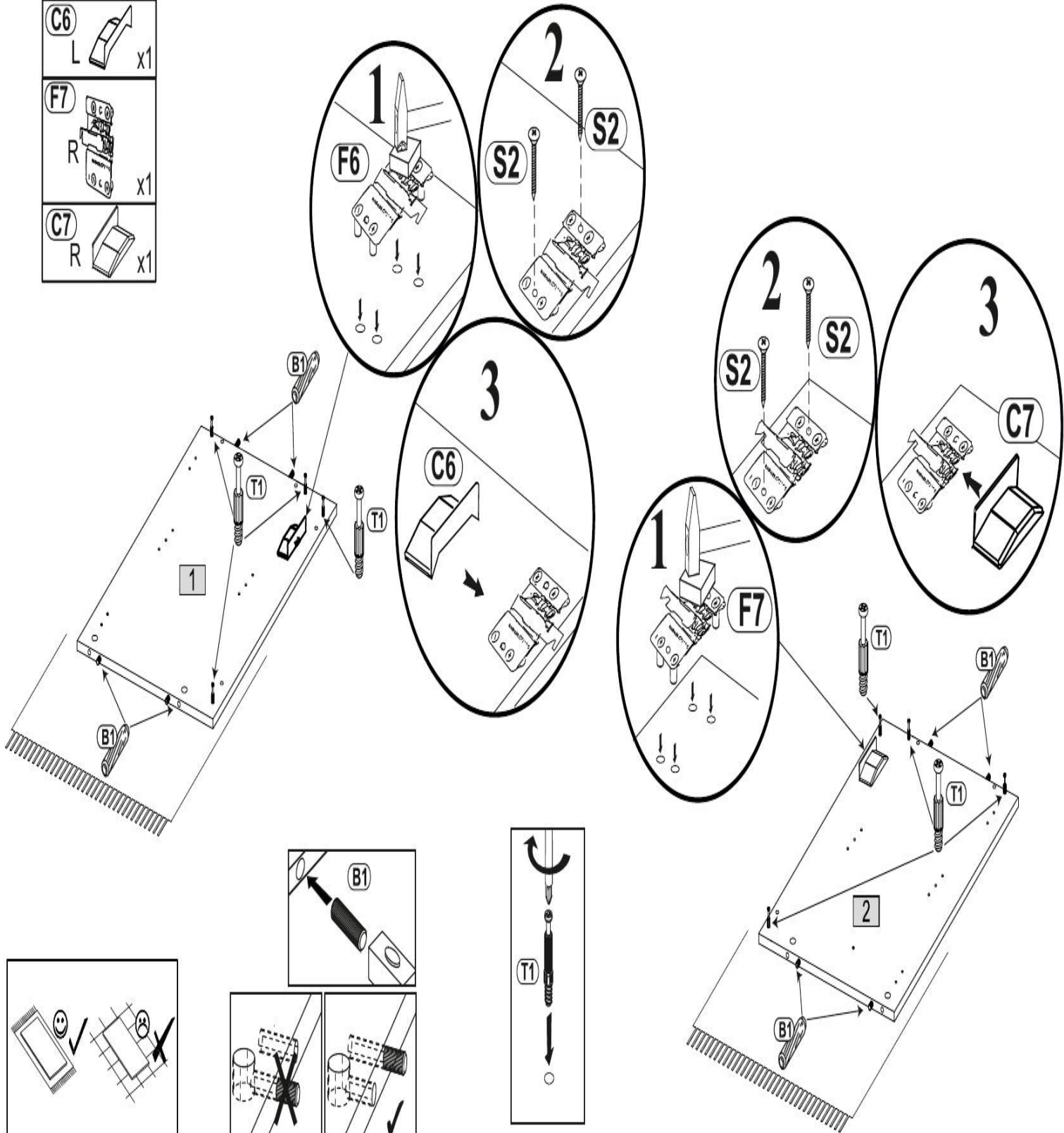
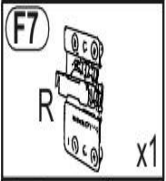
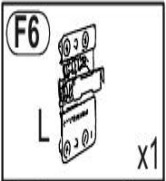
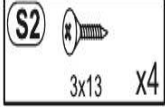
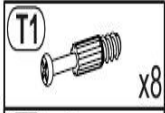
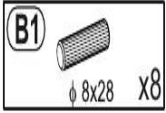

3

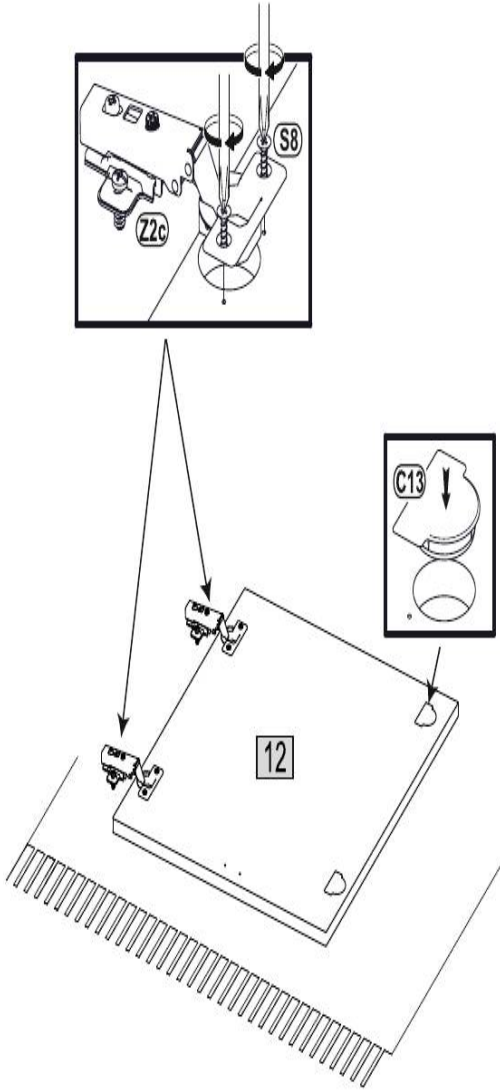
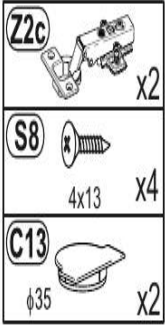

4

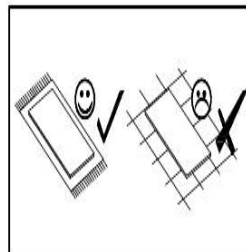
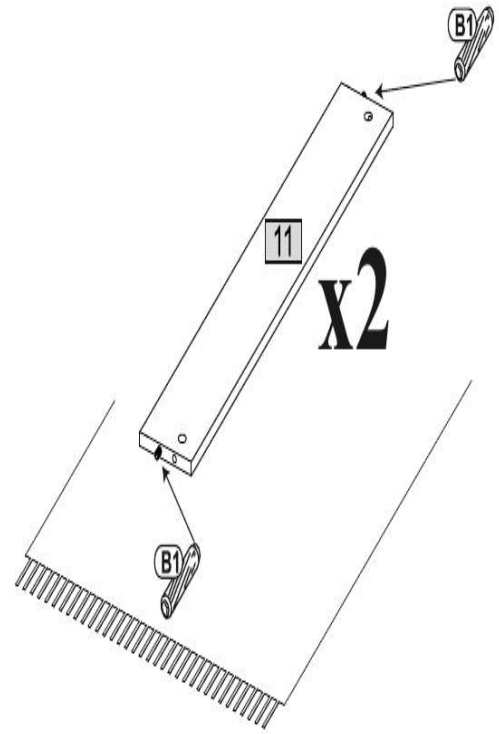
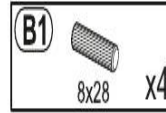

5

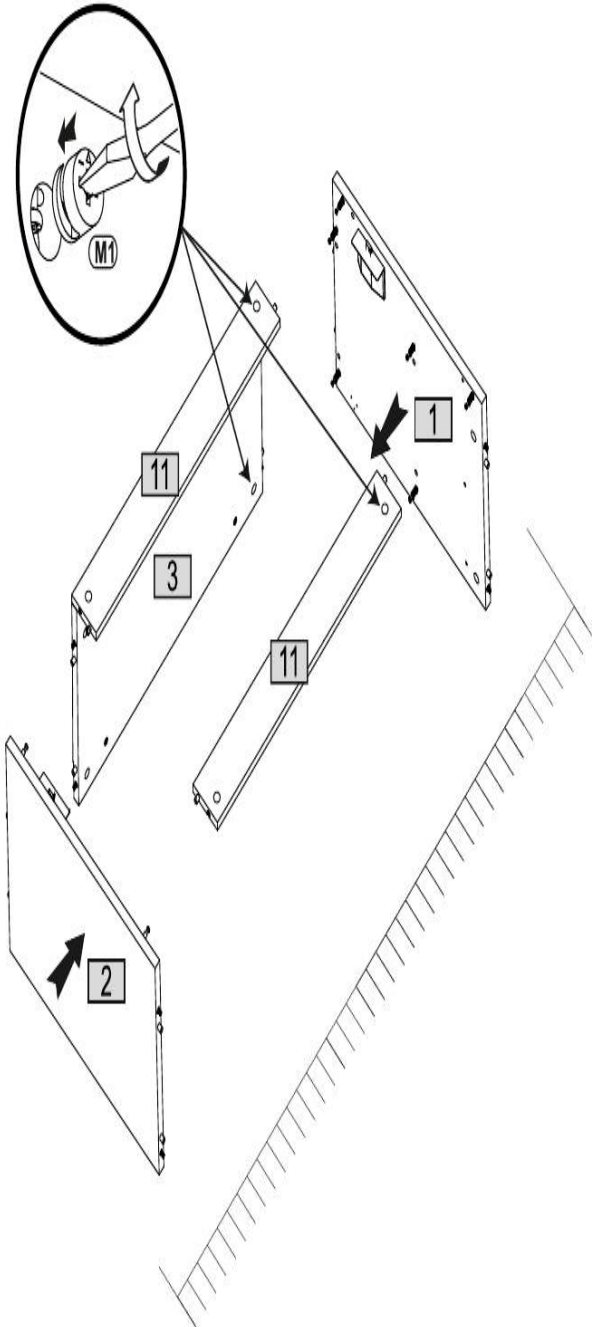

6

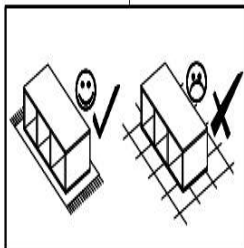
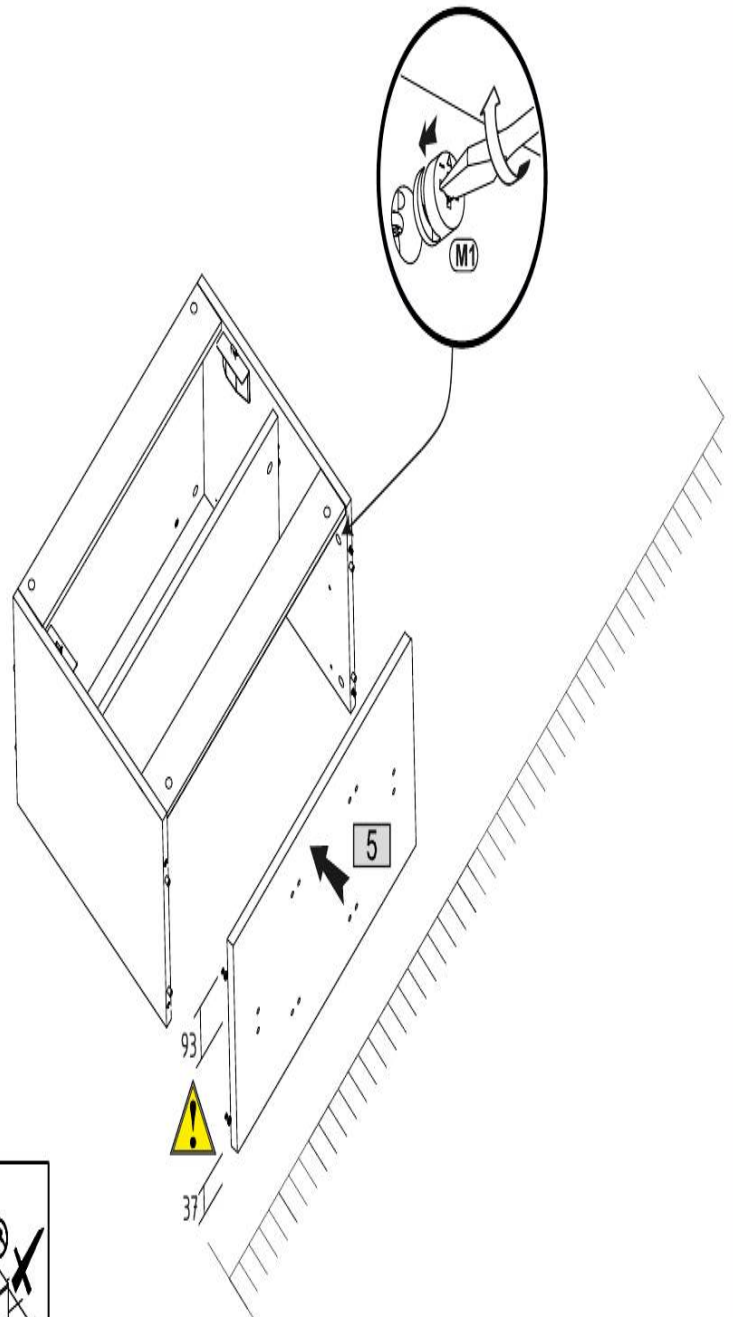

7 **P4** 4x25 X4

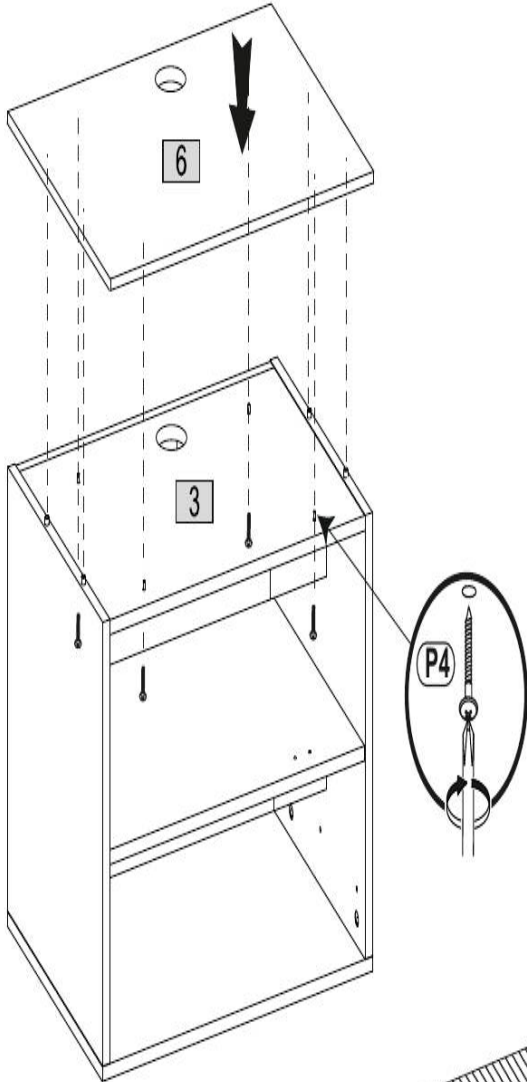

OPTION „A”

1-9

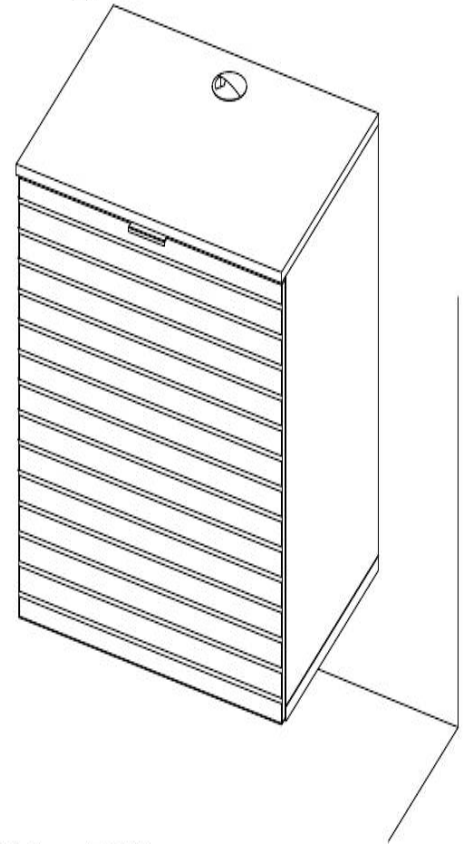

OPTION „B”

10-15

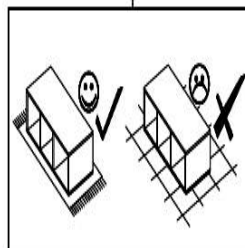
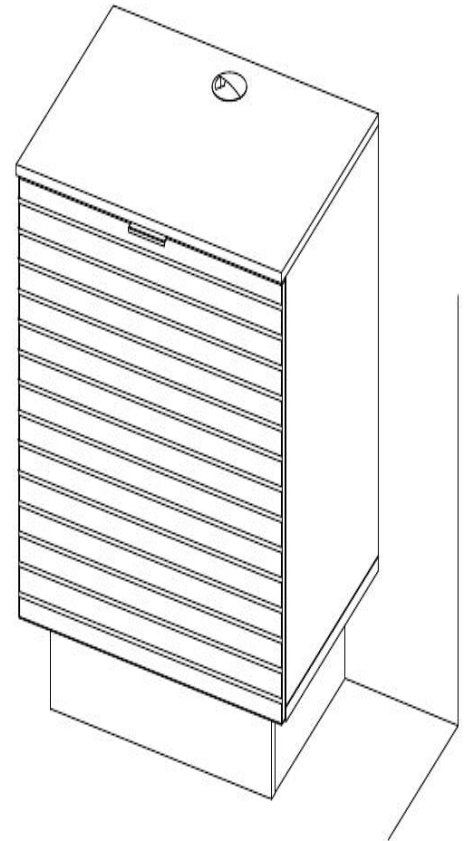

8

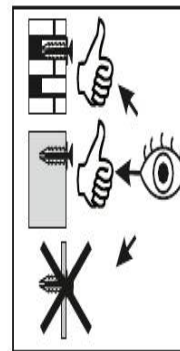
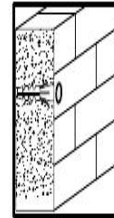
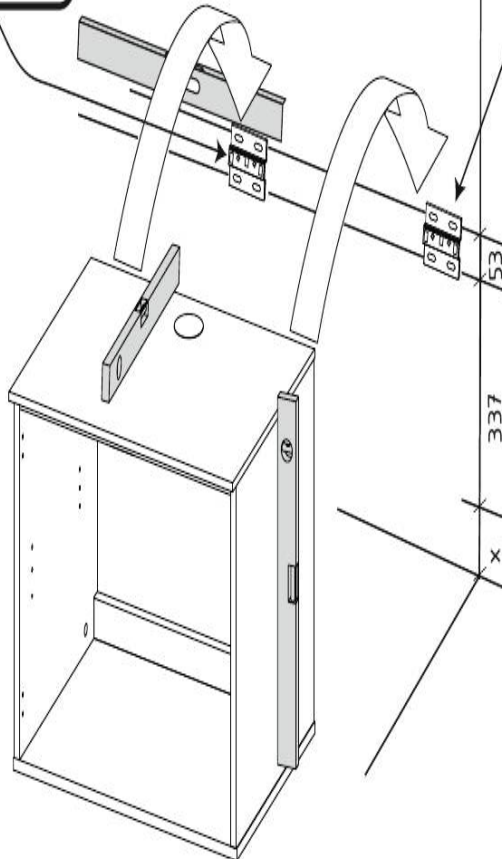
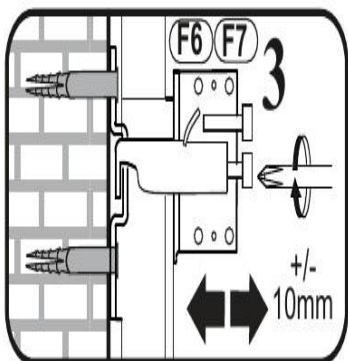
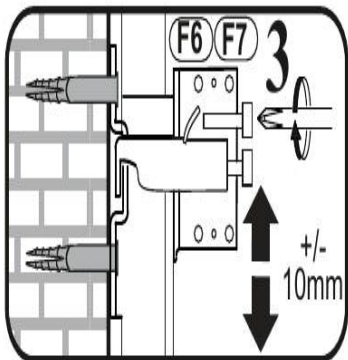
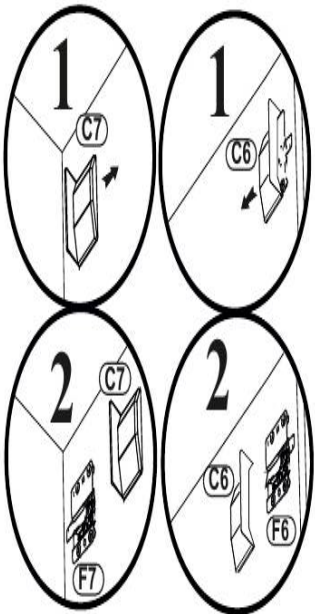
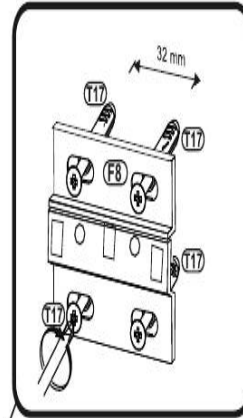
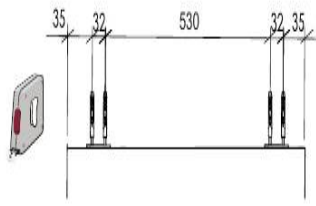
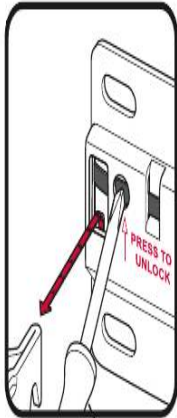
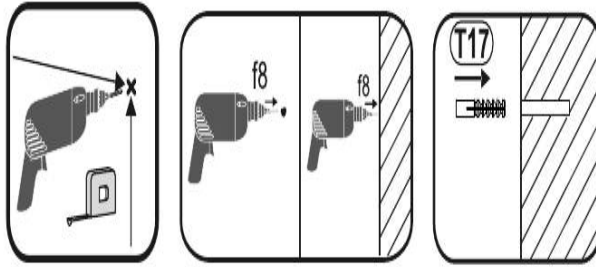
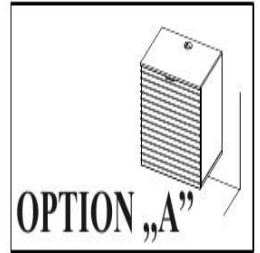
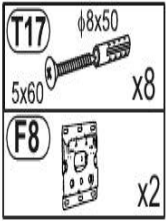

9

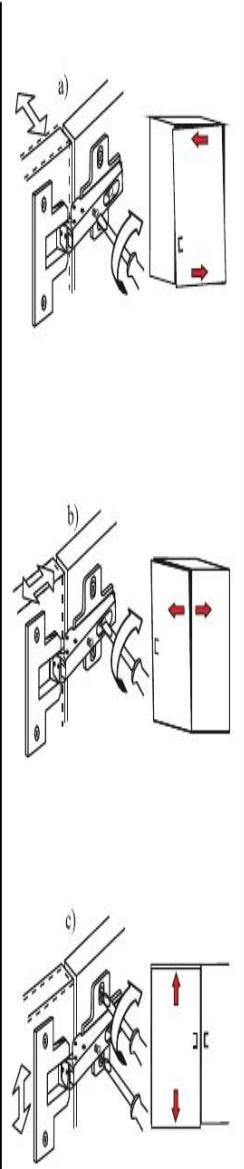
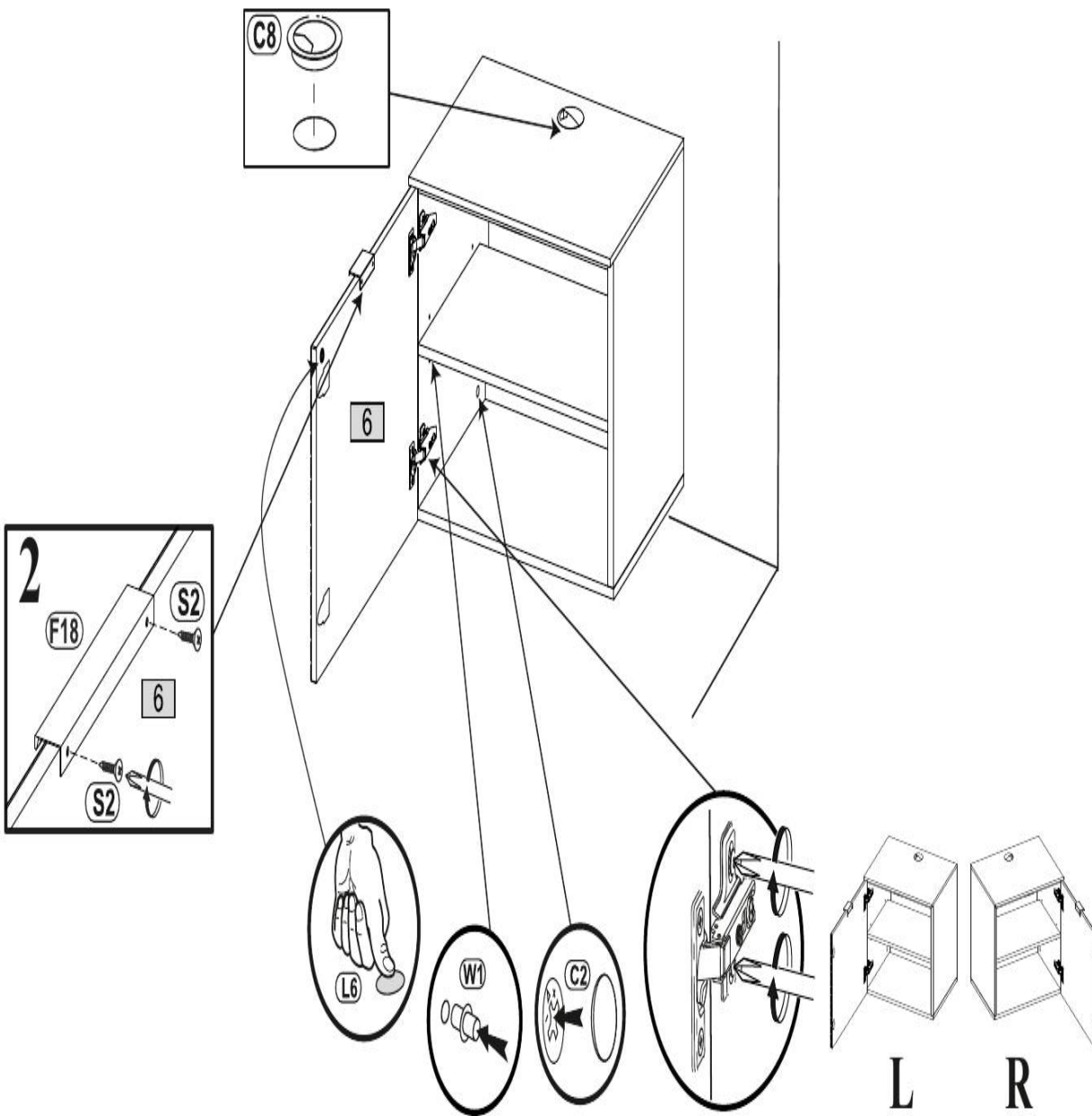
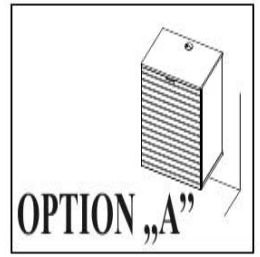
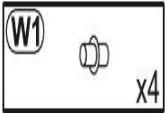
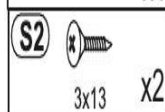
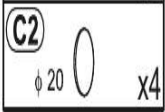
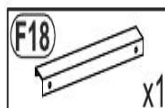
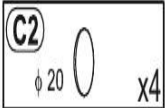

OPTION „B”

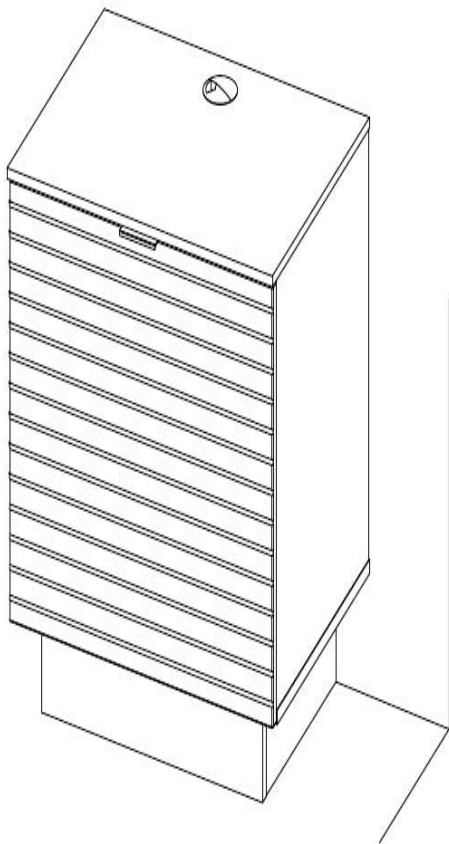

10-15

10

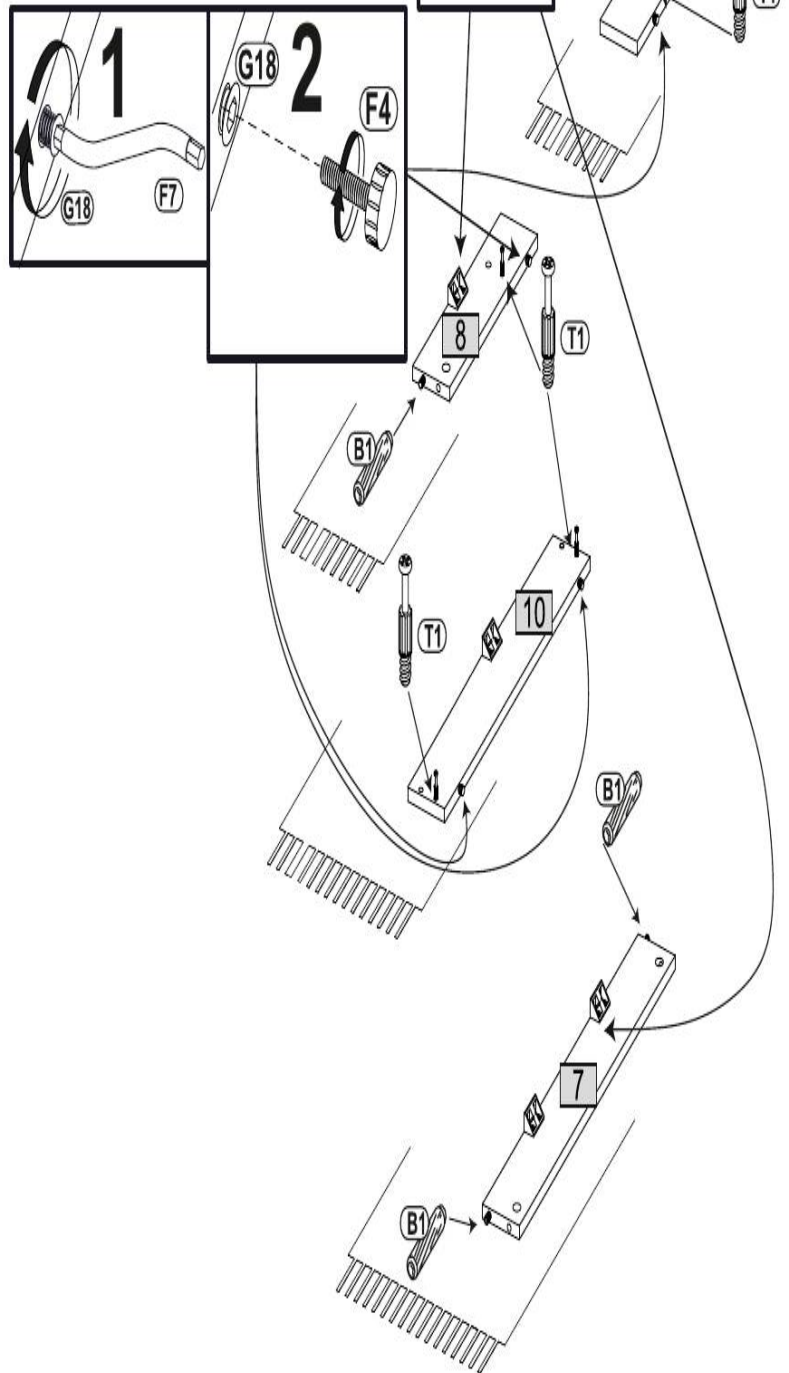
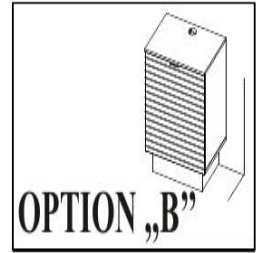
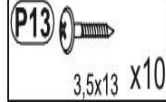
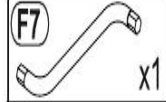
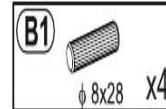
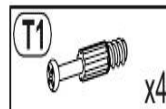

11

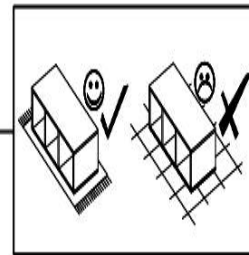
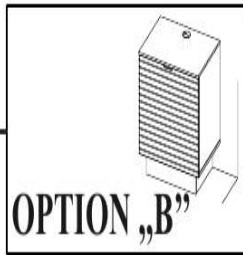
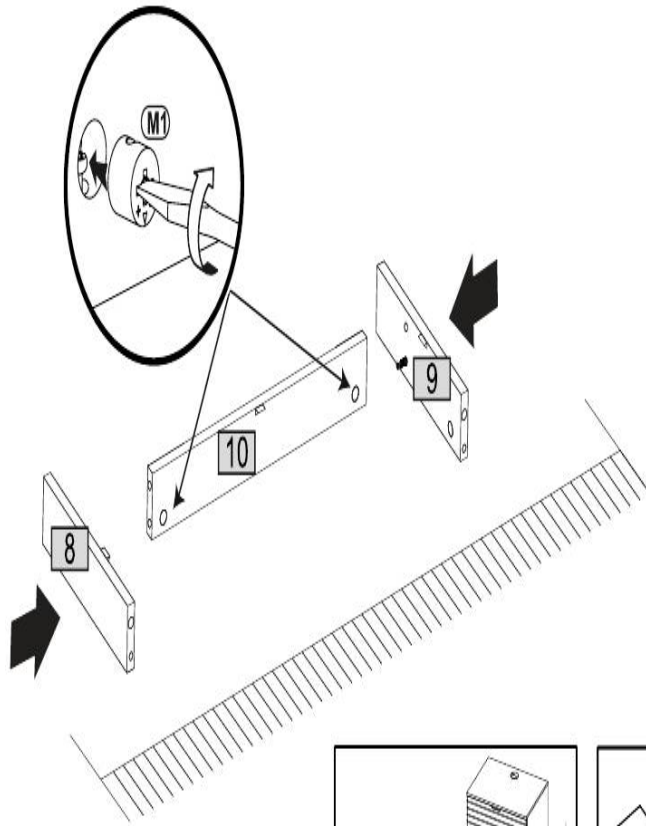

12

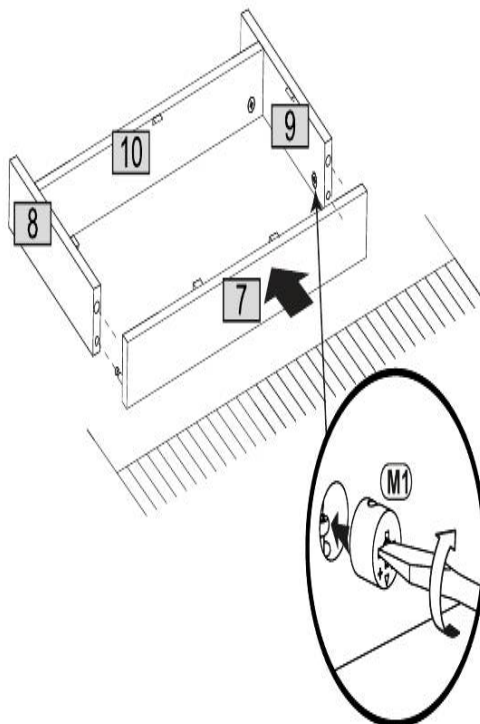

13

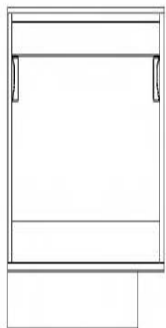
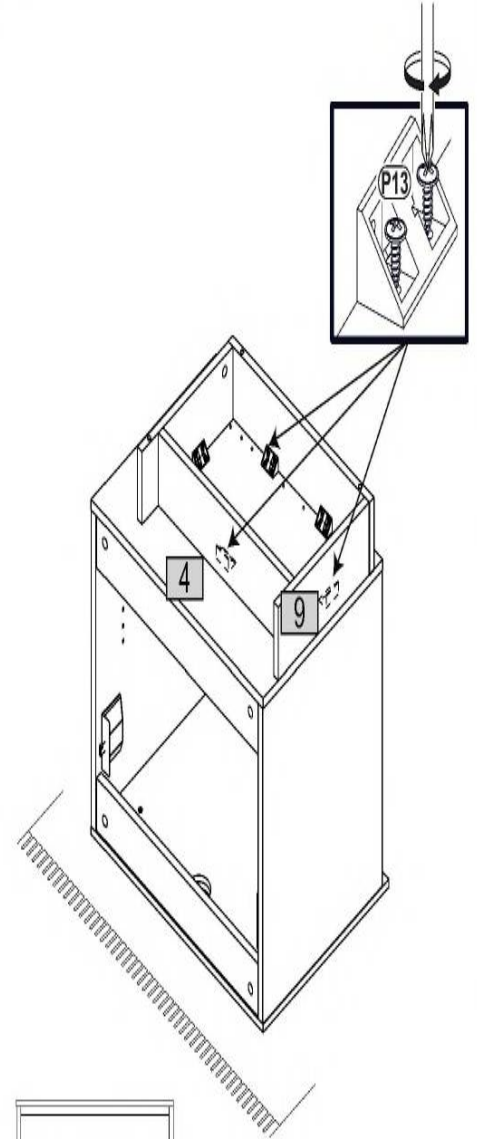
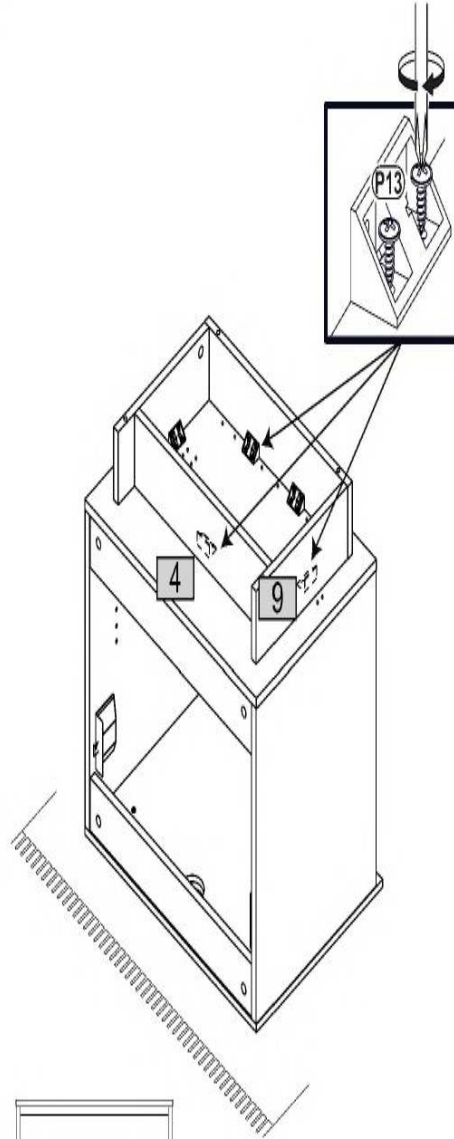
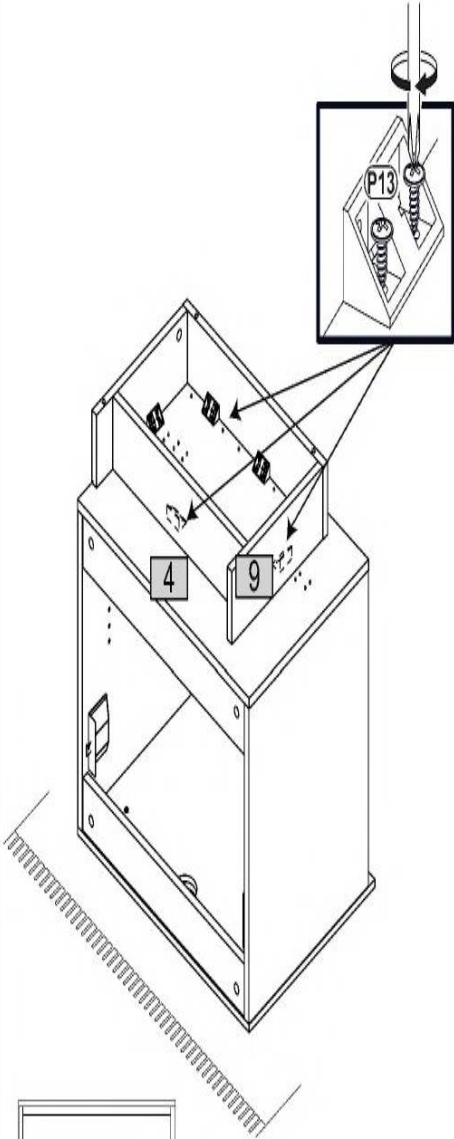
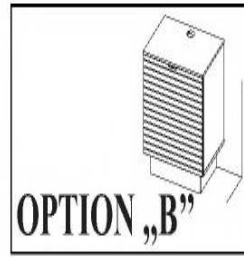
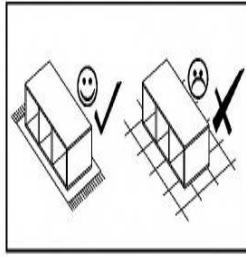
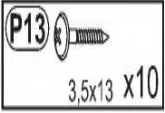

B1

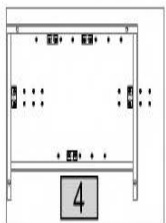

B2

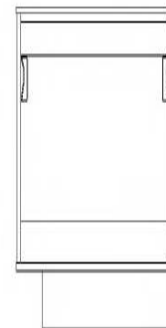
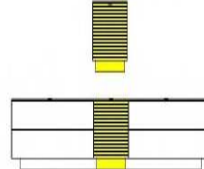
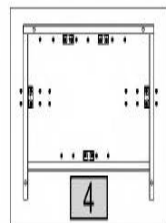

B3

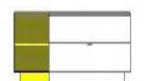
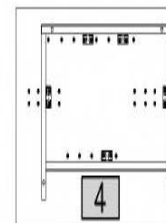

13

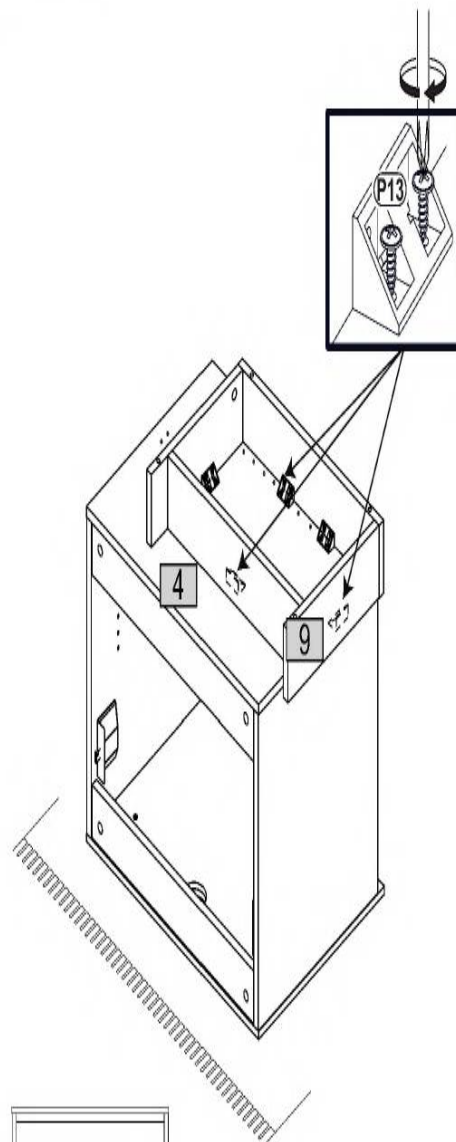
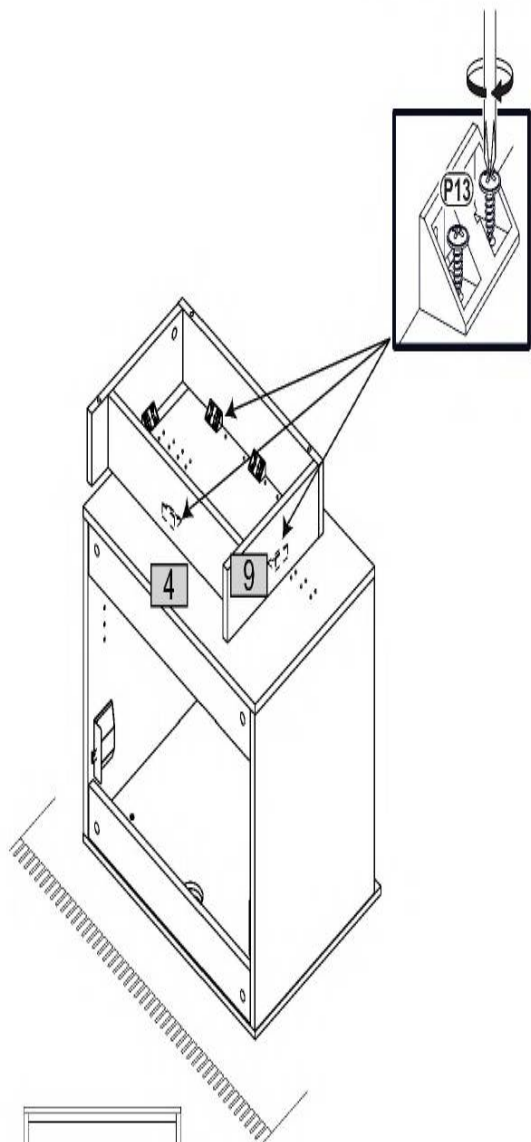
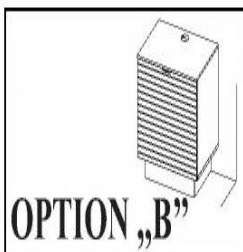
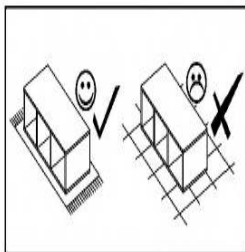
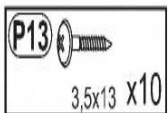

B4

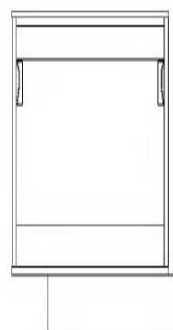
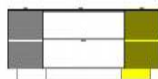
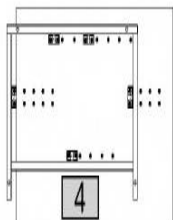

B5

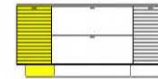
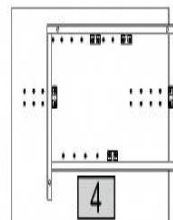

14

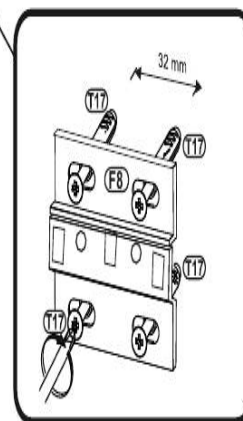
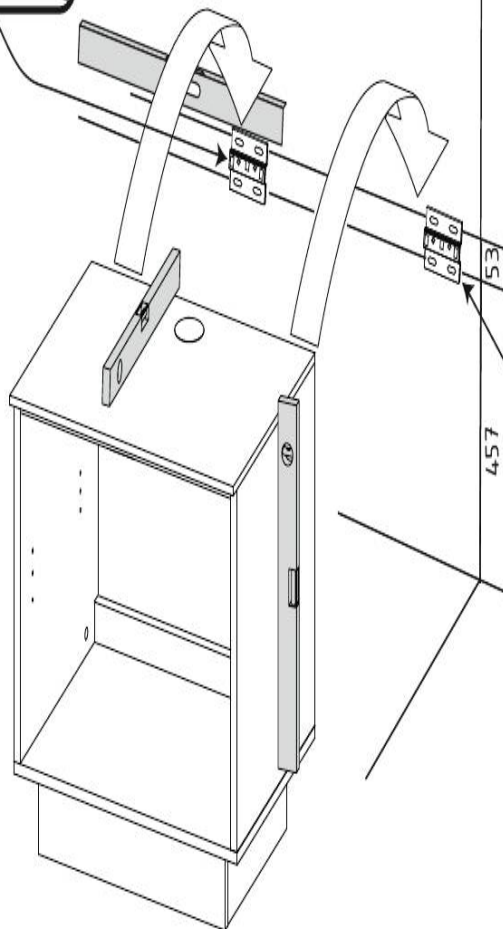
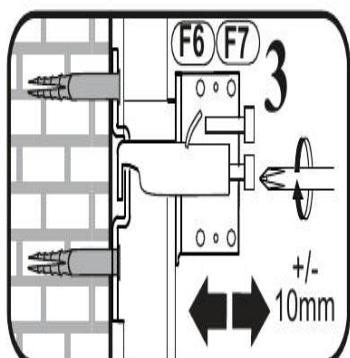
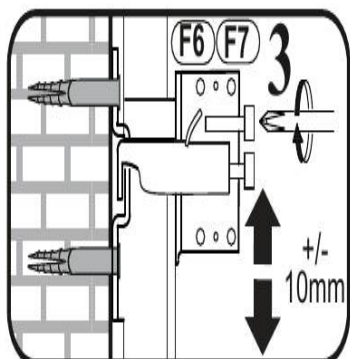
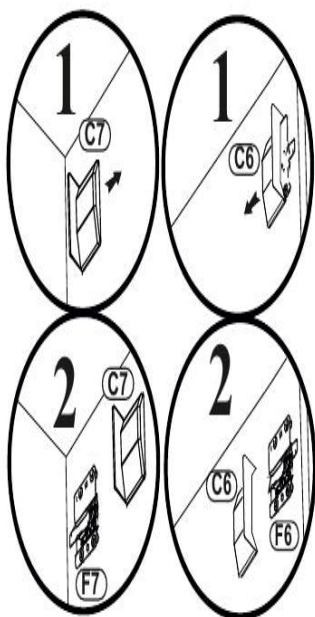
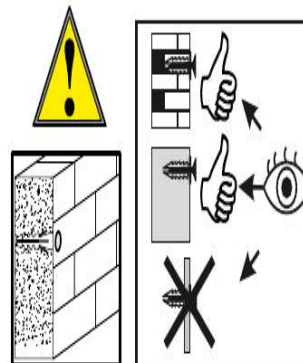
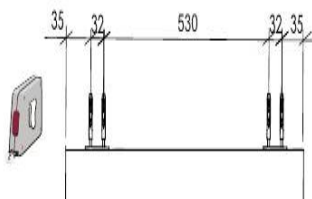
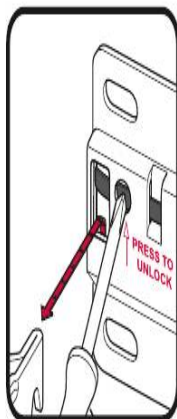
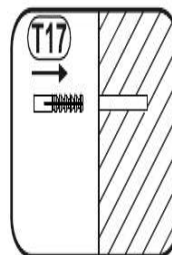
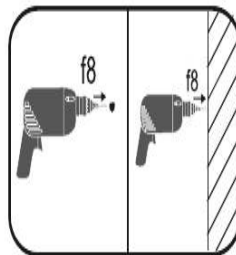
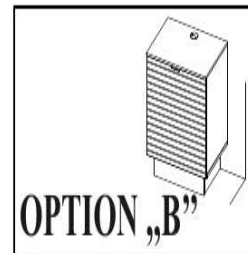
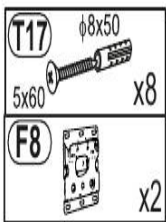

15

