

MONTÁŽNÍ/MONTÁŽNY NÁVOD BRIK

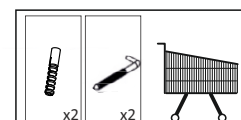

I

A	B	C	D	
1	BR2-001	1145	220	3/3
2	BR2-101	225	399	3/3
3	BR2-102	225	399	3/3
4	BR2-103	377	225	3/3
5	BR2-104	377	225	3/3
6	BR2-401	982	225	3/3
7	BR2-901	749	252	1/3
8	BR2-902	395	493	1/3
9	LH-224	224		1/3
10	BR2-201	2400	400	1/3
11	BR2-202	2400	400	1/3
12	BR2-203	2400	400	1/3

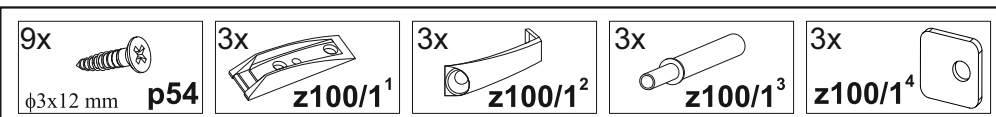
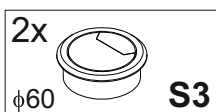
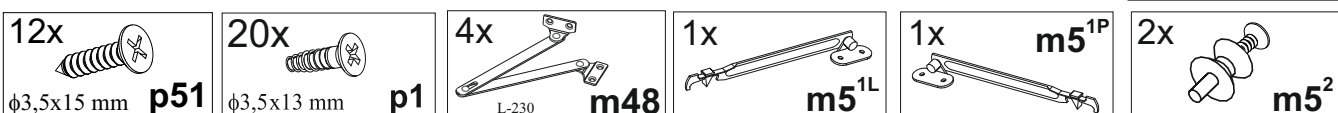
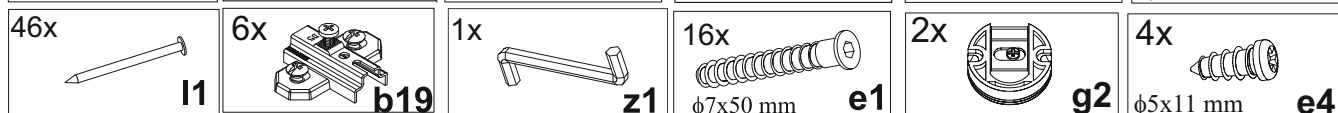
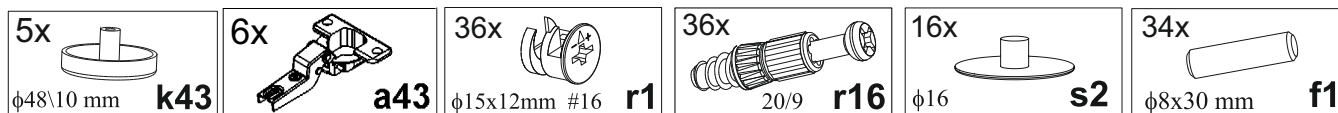
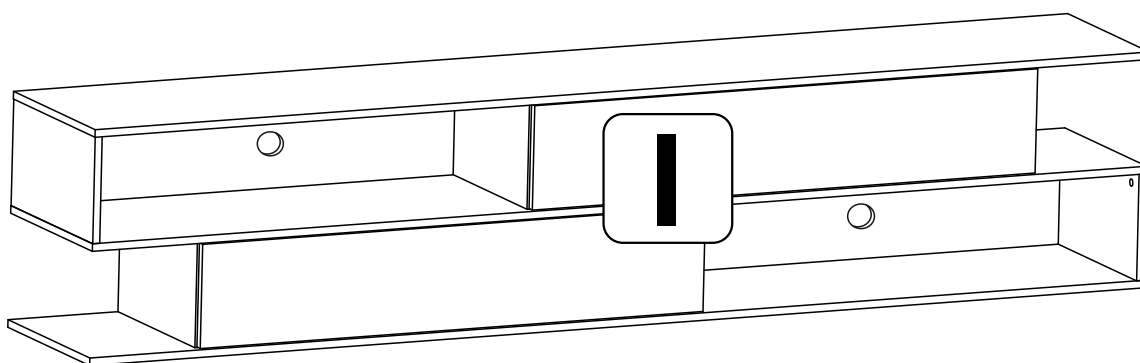
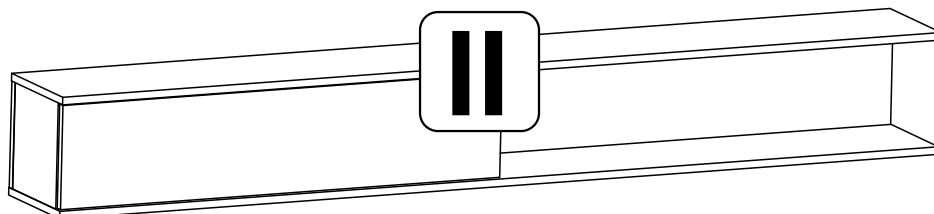
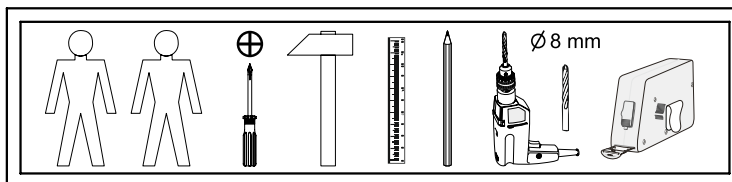
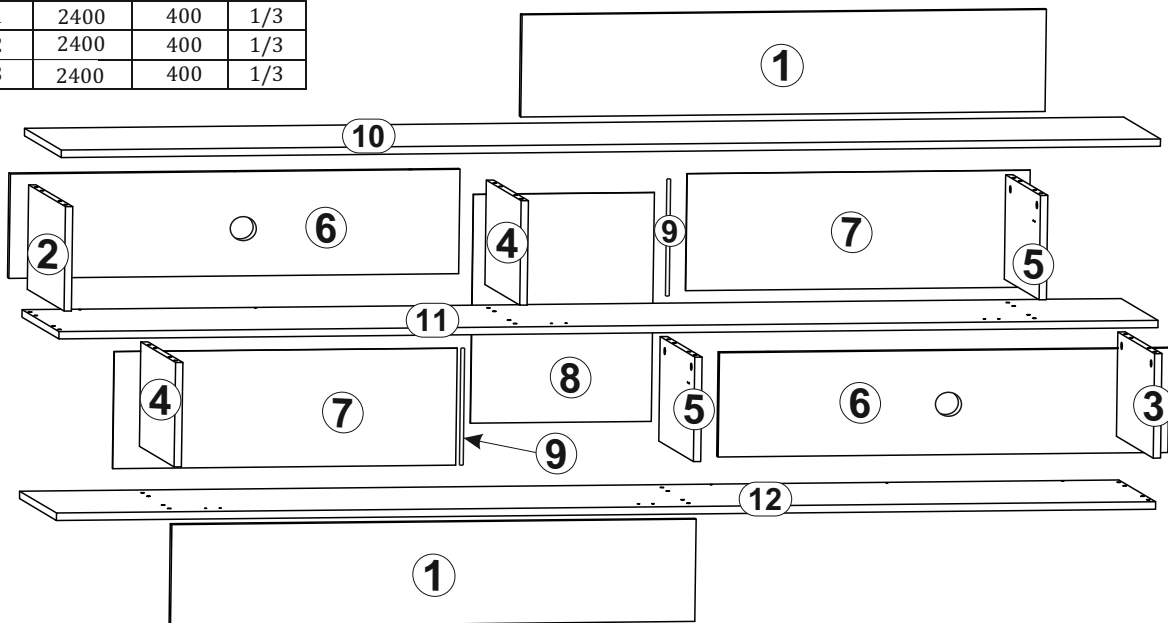

1

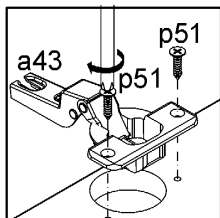
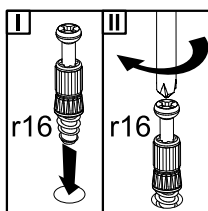
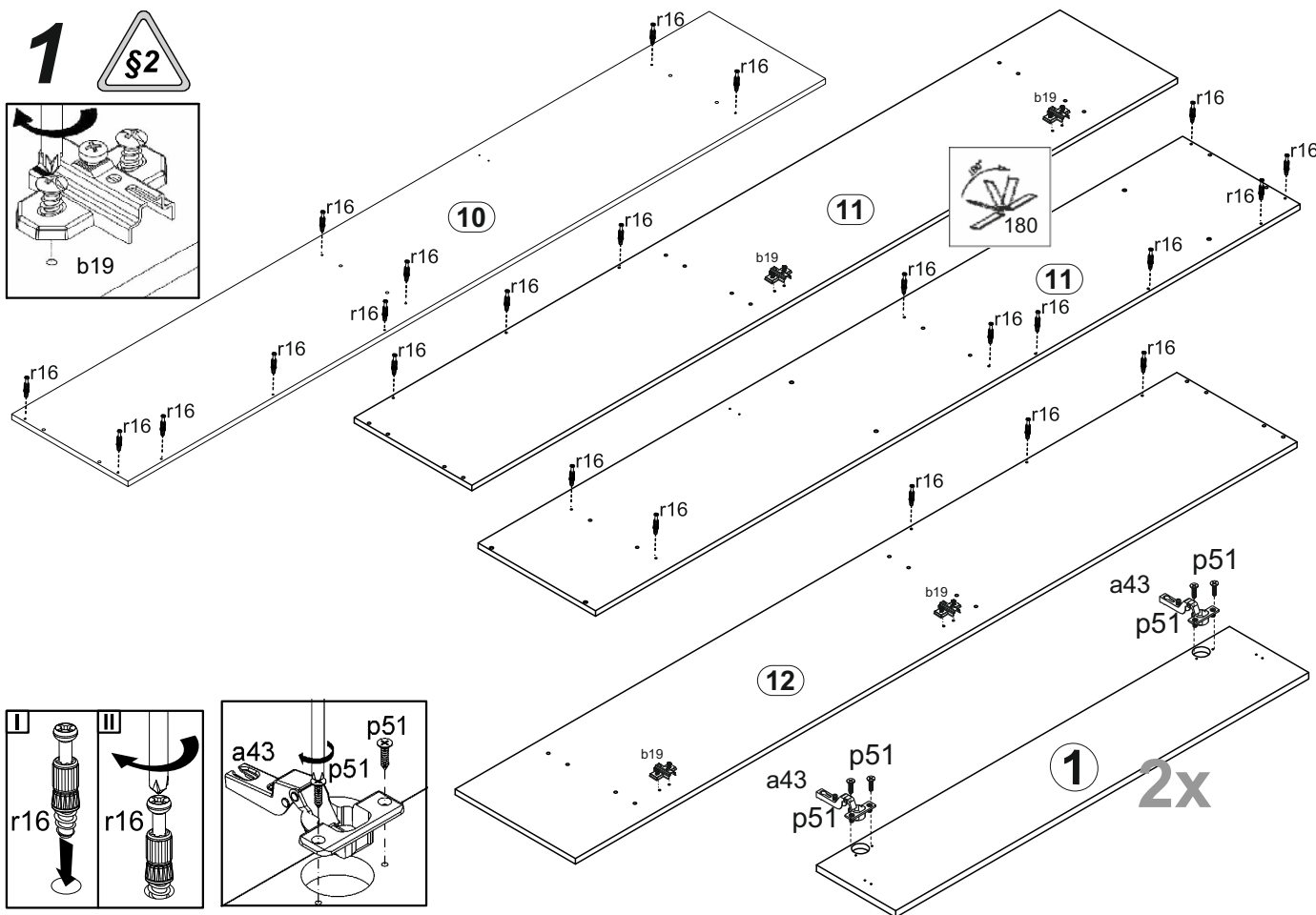
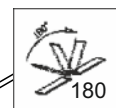
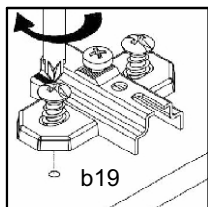

2

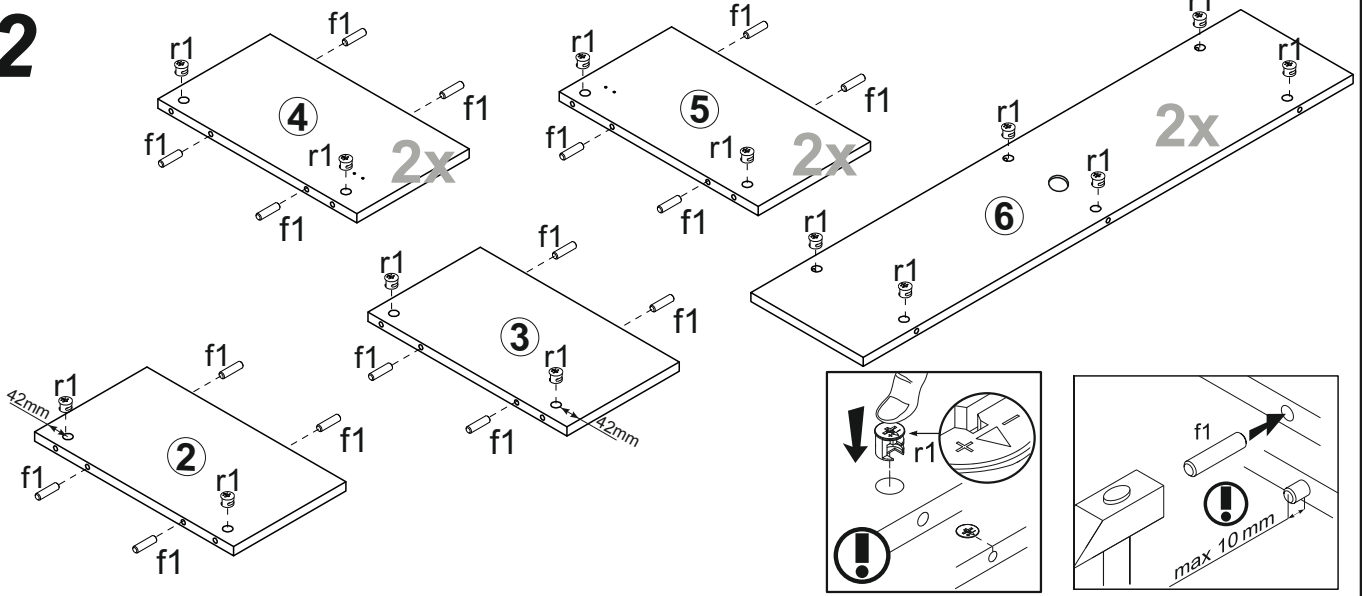

3

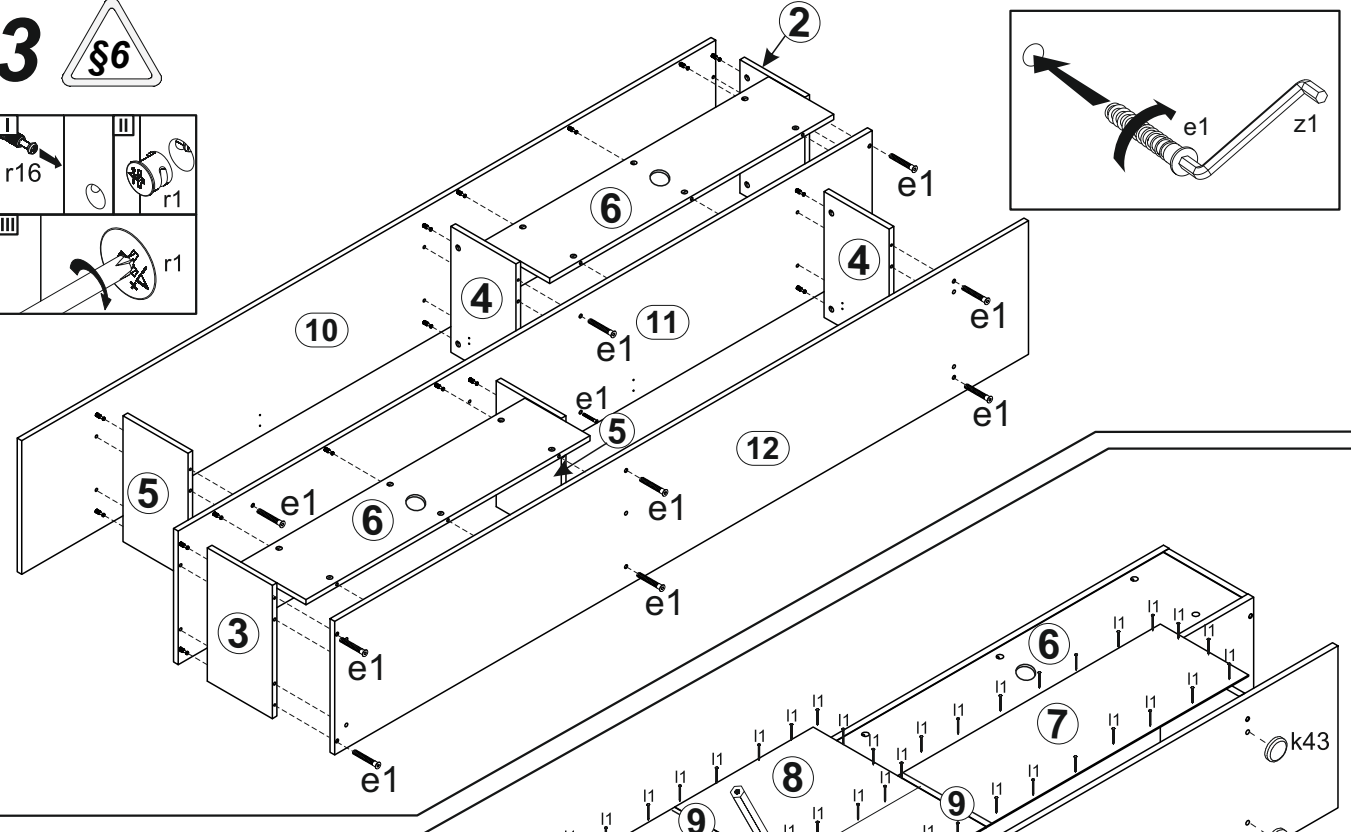
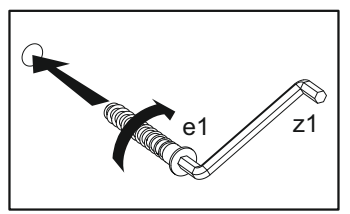
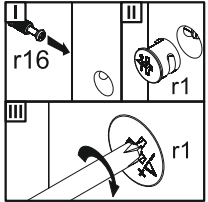

4

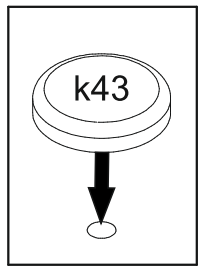
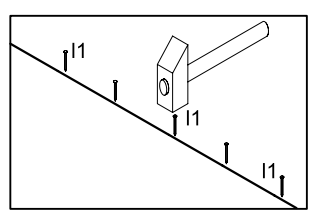
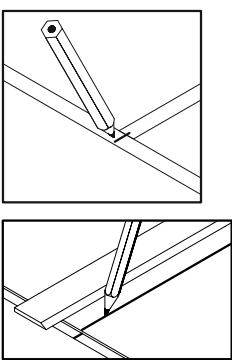
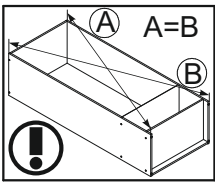

5

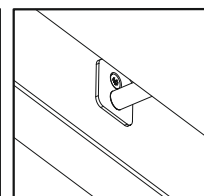
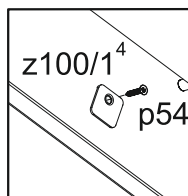
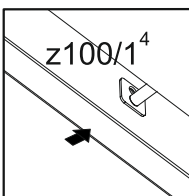
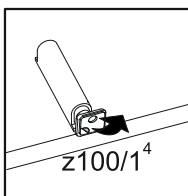
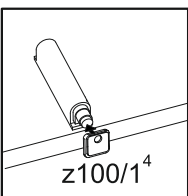
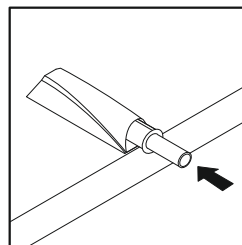
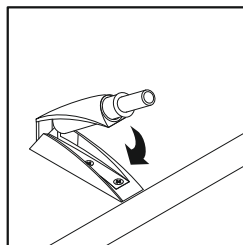
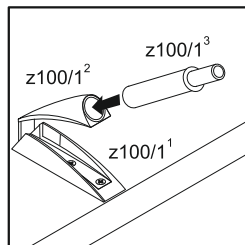
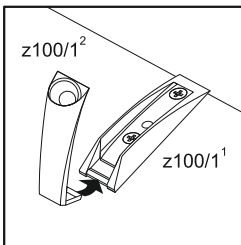
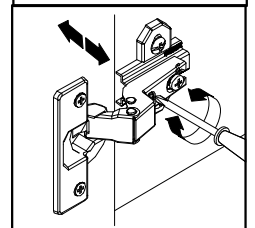
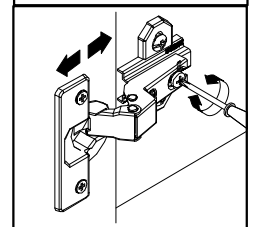
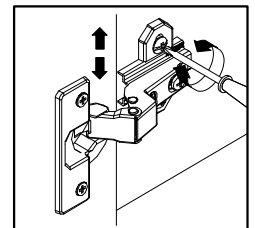
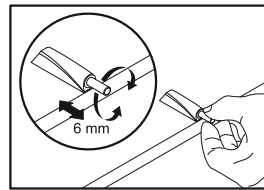
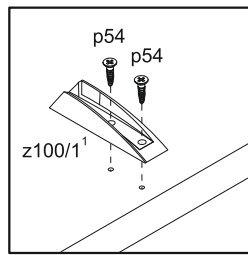
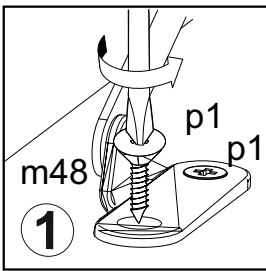
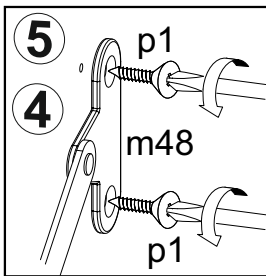
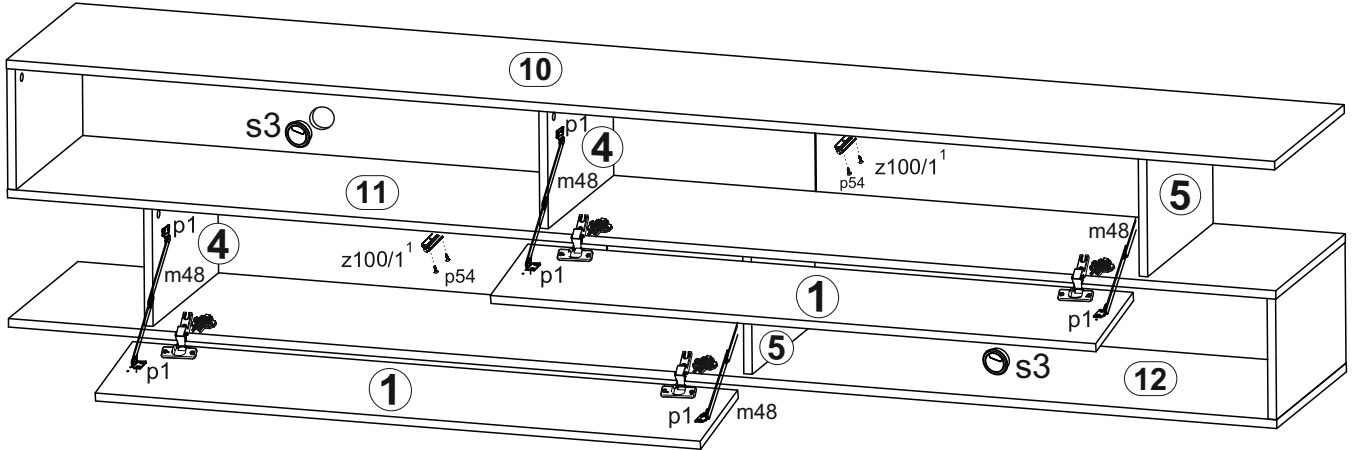
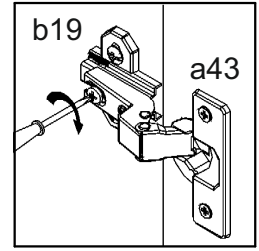
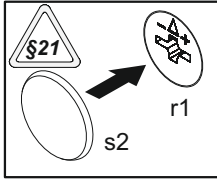

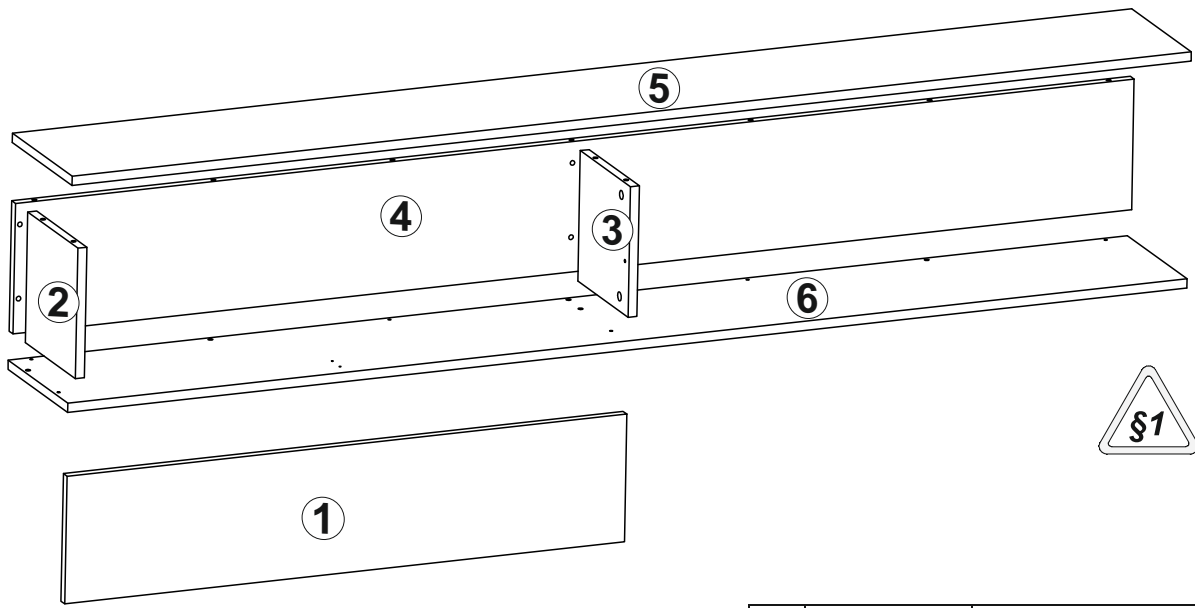

A	B	C	D	
1	BR2-002	1000	220	3/3
2	BR2-105	210	225	3/3
3	BR2-106	210	225	3/3
4	BR2-402	1999	225	2/3
5	BR2-204	2000	250	2/3
6	BR2-205	2000	250	2/3

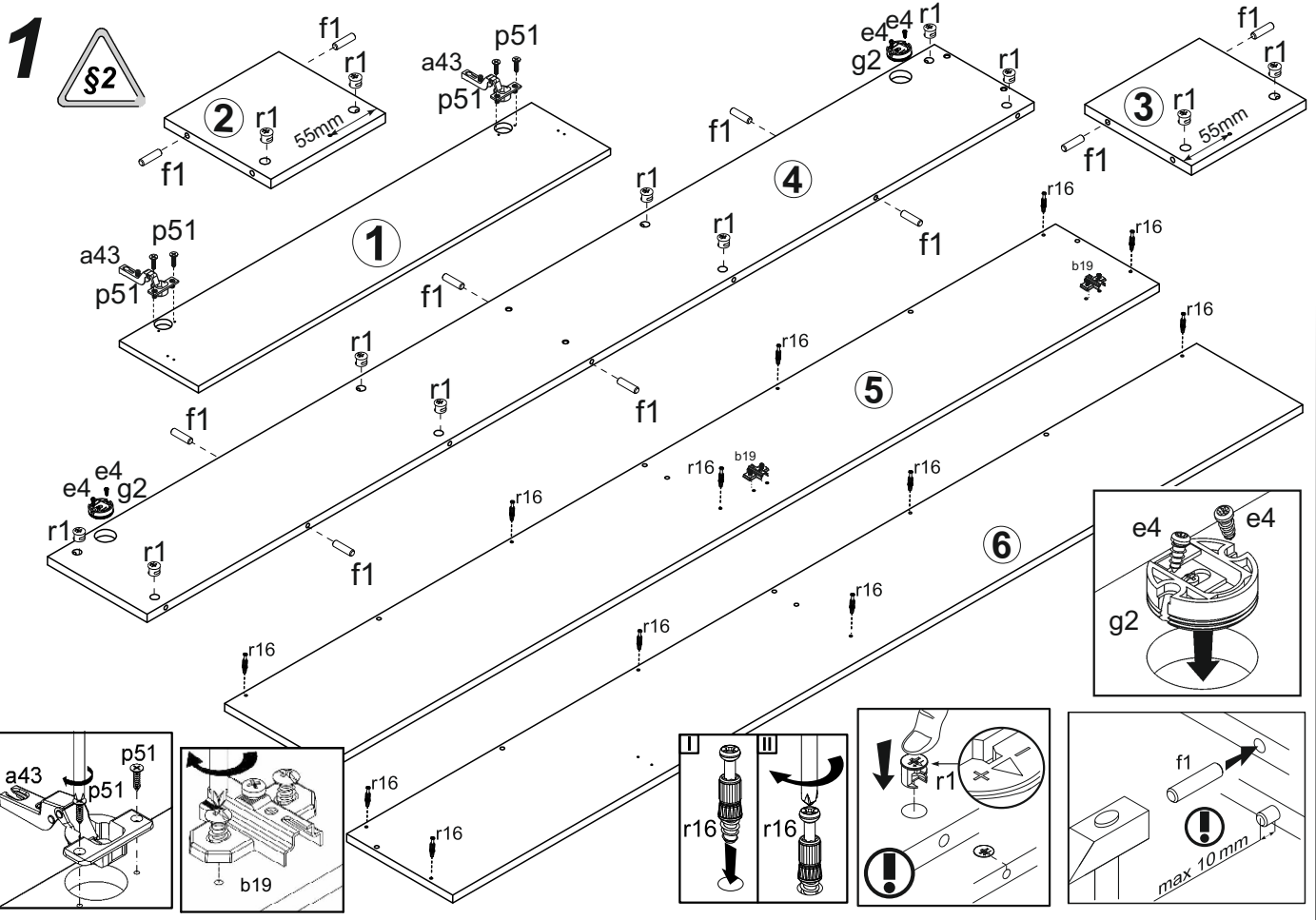

2

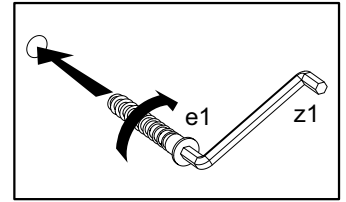
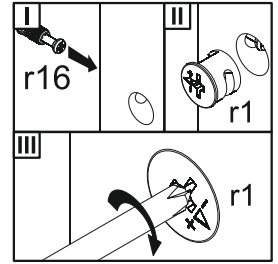
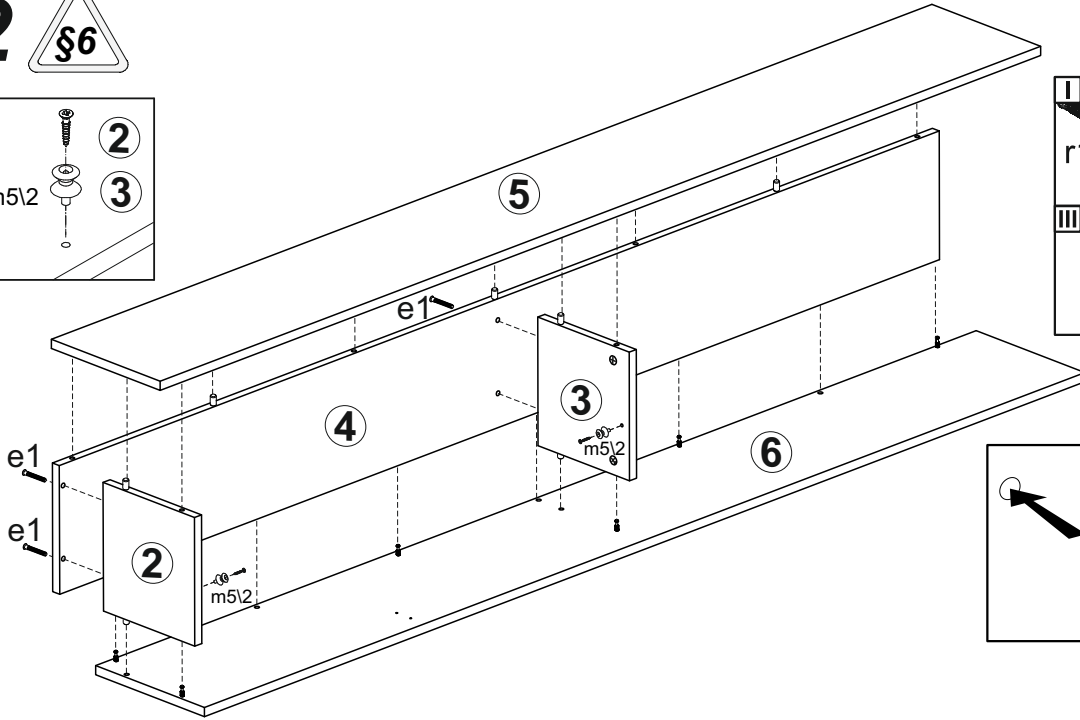
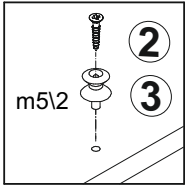

3

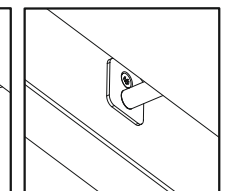
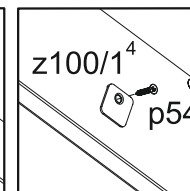
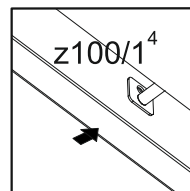
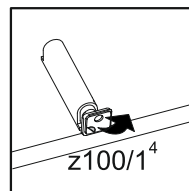
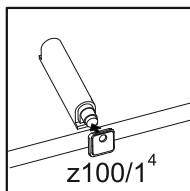
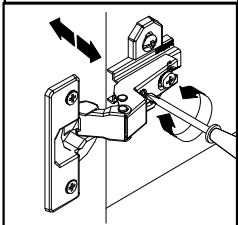
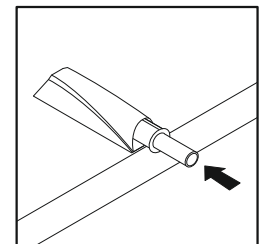
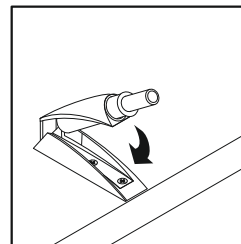
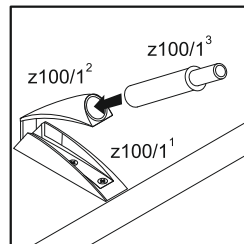
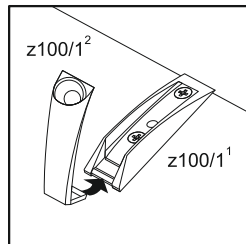
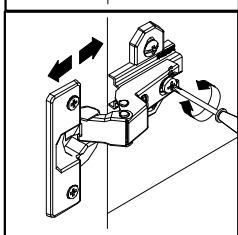
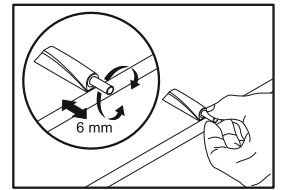
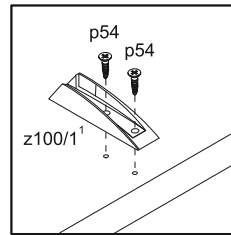
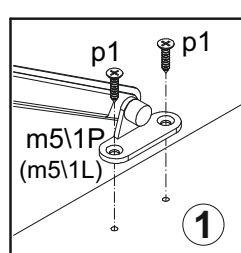
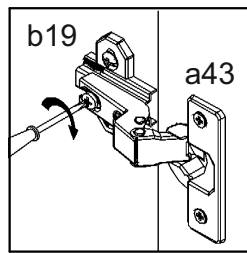
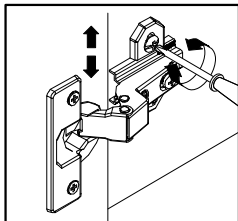
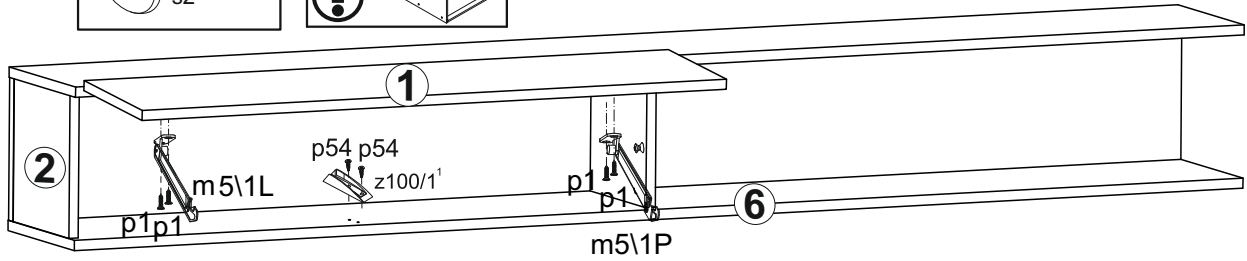
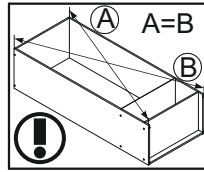
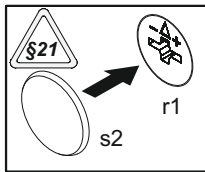

4

