

Č. rozmer / rozměr ks

Nr	Ausmaß	St	Colli
1	2018 25 25 2	1	1
2	900 120 15 1	1	1
3	900 120 15 1	1	1
4	450 100 12 3	4	4
5	450 100 12 3	4	4
6	2010 210 15 1	2	2
7	667 105 15 1	2	2
8	667 105 15 1	2	2
9	667 105 15 1	2	2
10	1982 900 15 1	2	2
11	2020 180 18 1	1	1
12	2020 520 18 1	1	1
13	2020 230 15 1	1	1
14	1204 200 15 2	4	4
15	1204 200 15 2	4	4
16	2020 180 15 1	2	2
17	1260 750 22 1	3	3
18	1260 750 22 1	3	3
19	621 100 12 3	4	4
20	1982 104 15 1	1	1
21	632 449 2 3	3	3

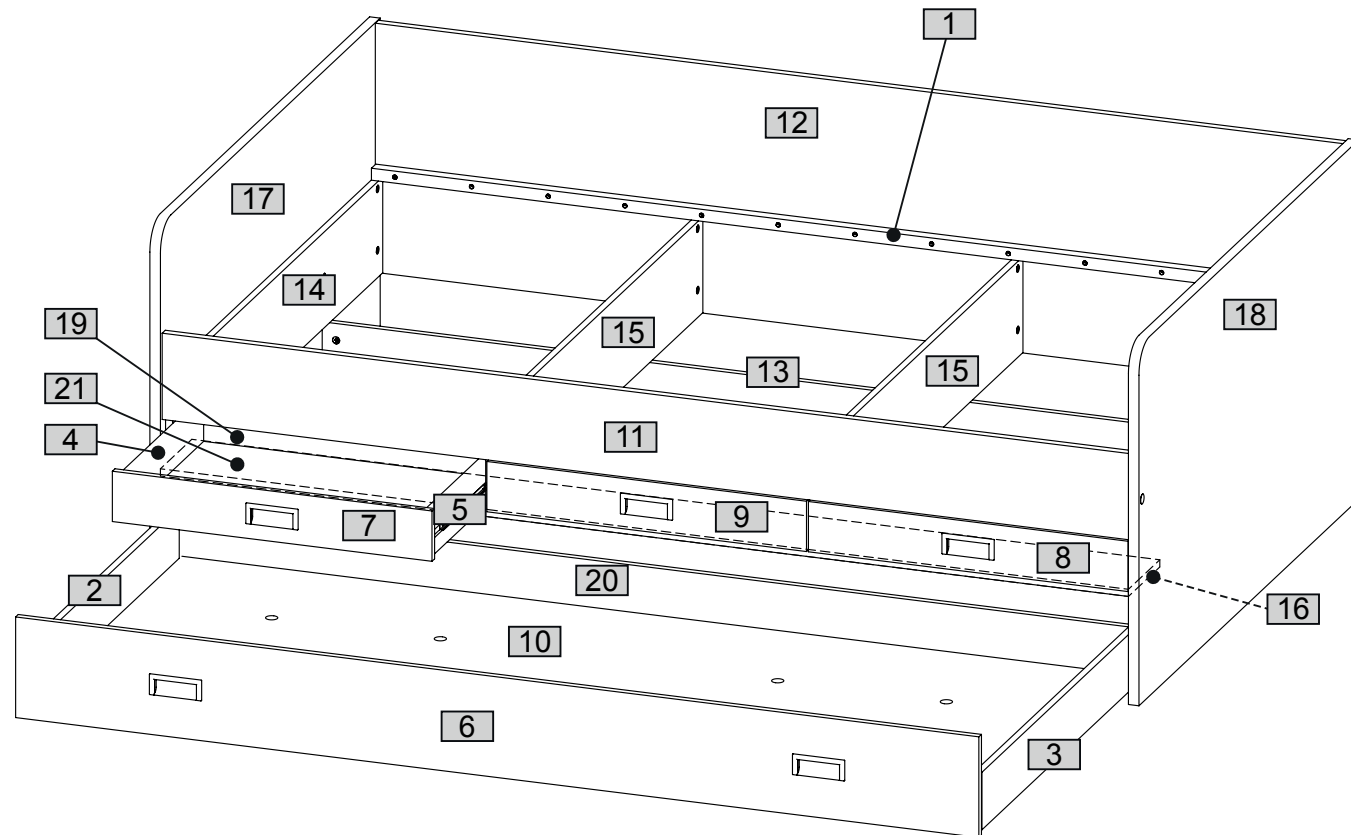

0 10 20 30 40 50 60 70 80 90 100 110 120 130 140 150 160 170 180 190 200

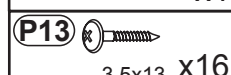
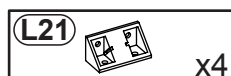
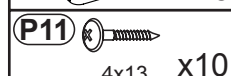
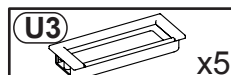
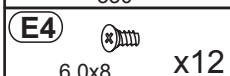
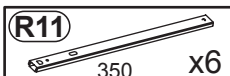
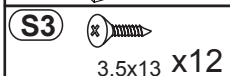
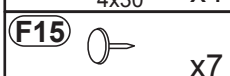
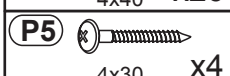
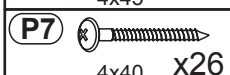
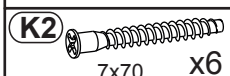
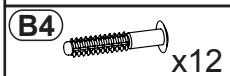
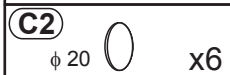
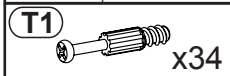
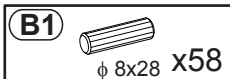

1

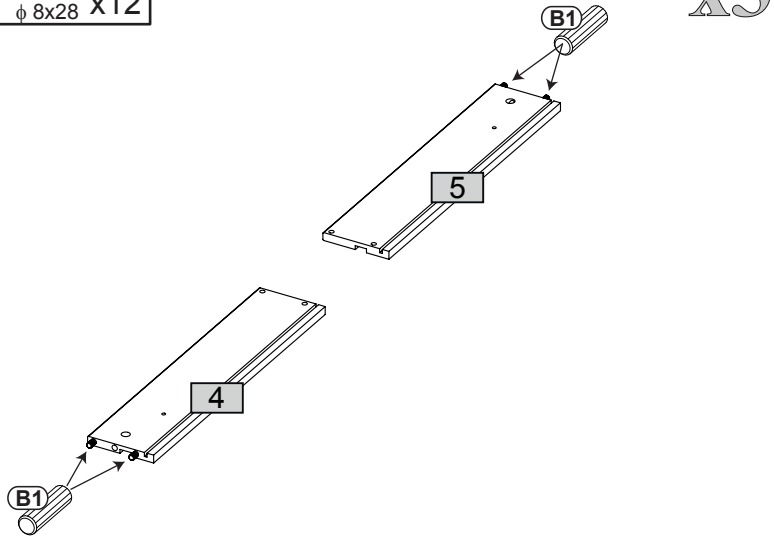
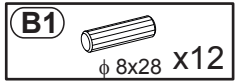

2

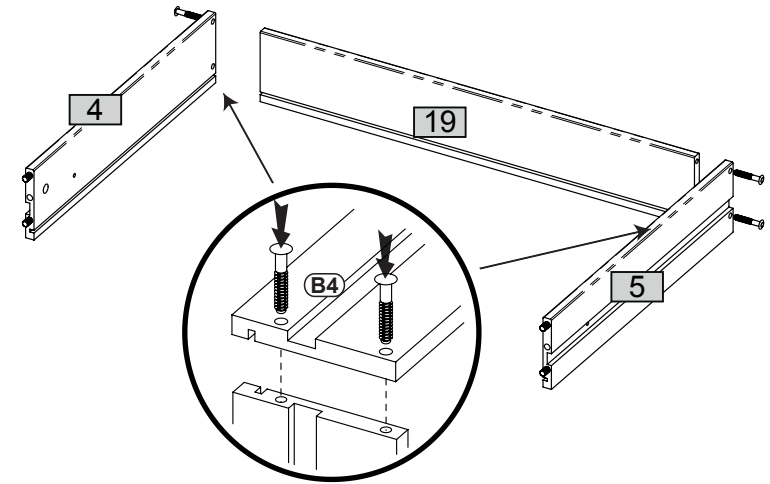
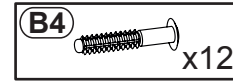

3

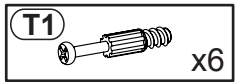

x3

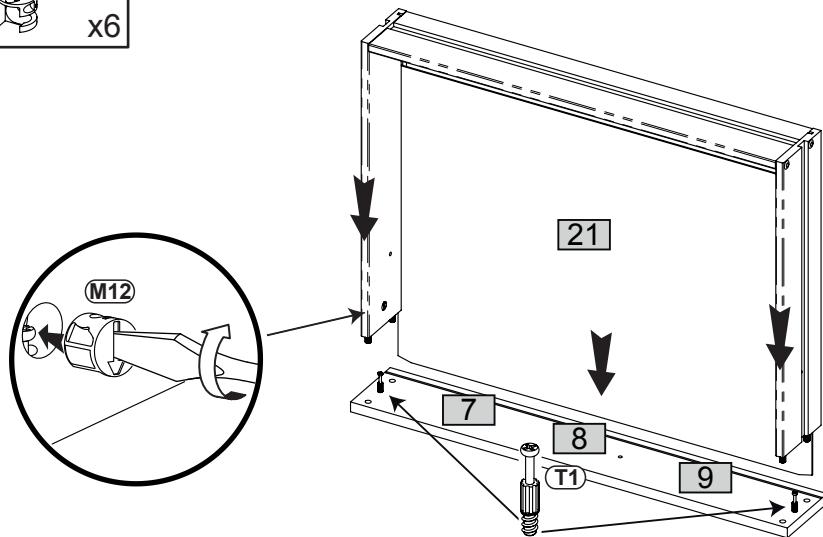

4

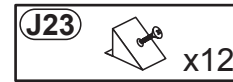

x3

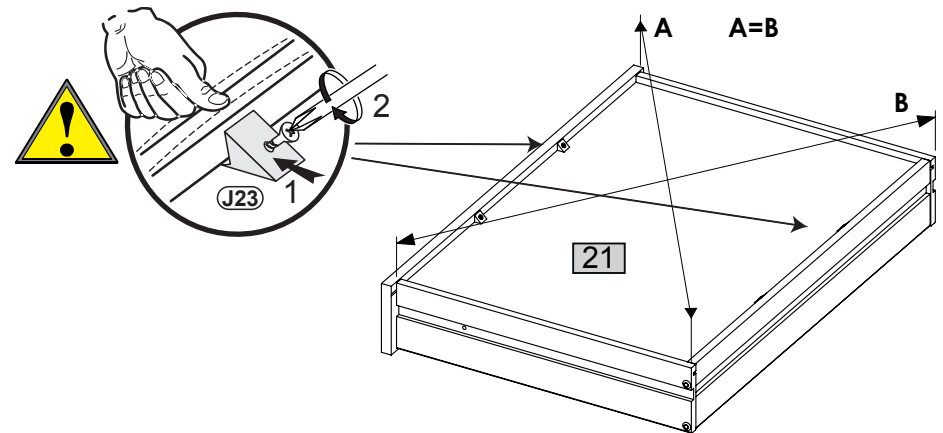

5

B1  $\phi 8 \times 28 \times 14$

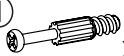
T1  x16

I4  x6

S3  3,5x13 X12

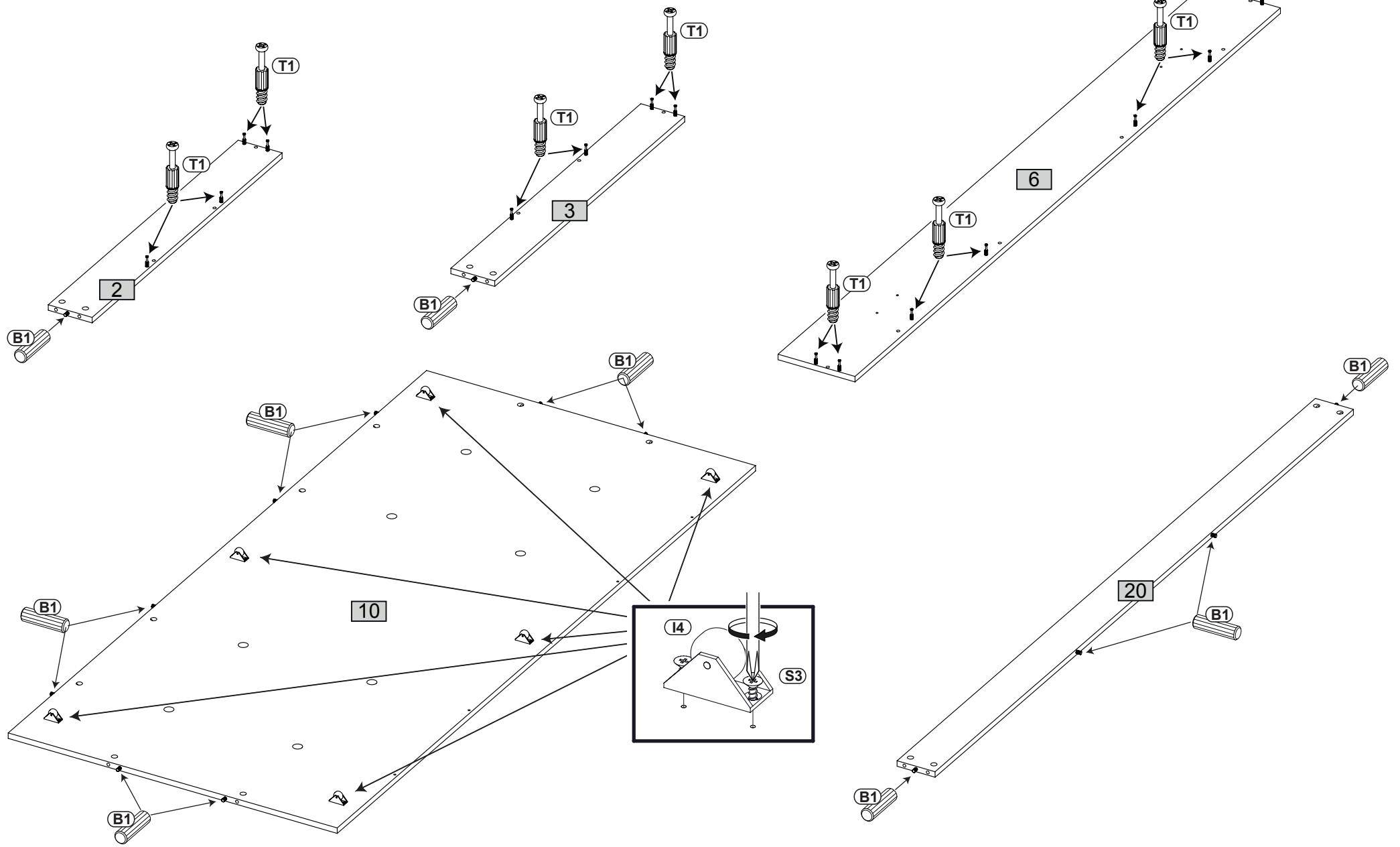

6

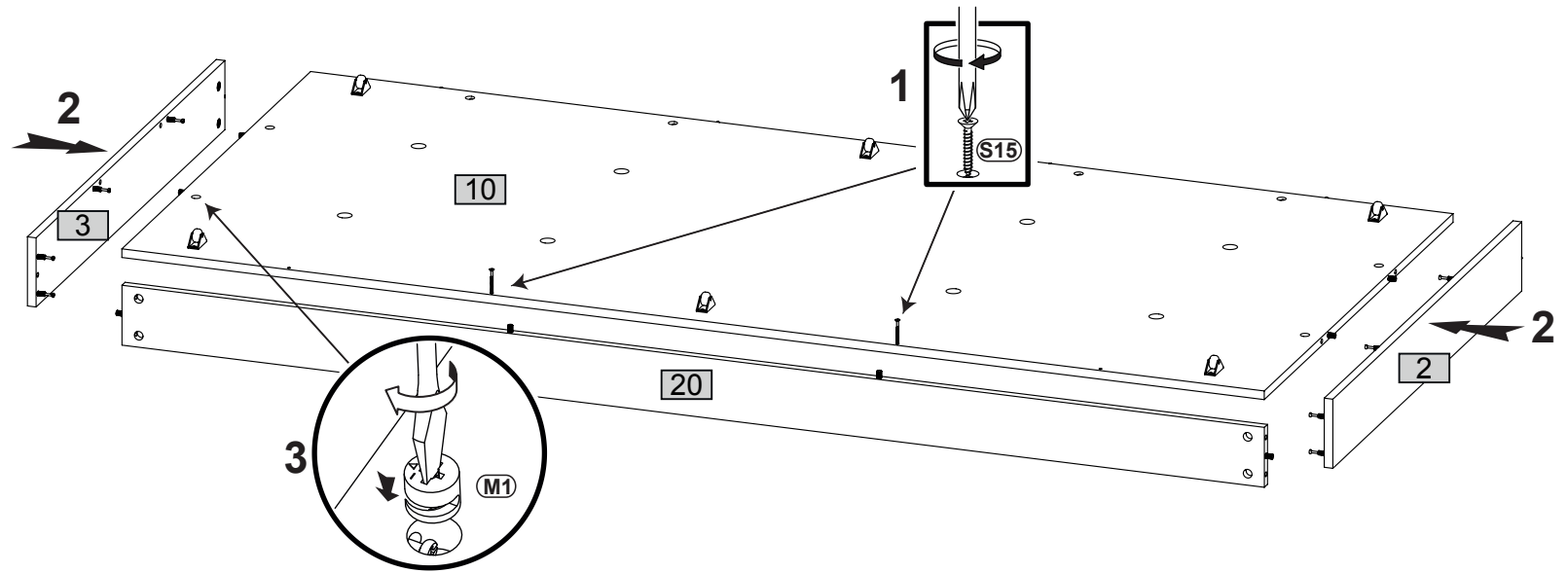
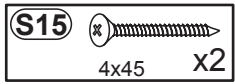

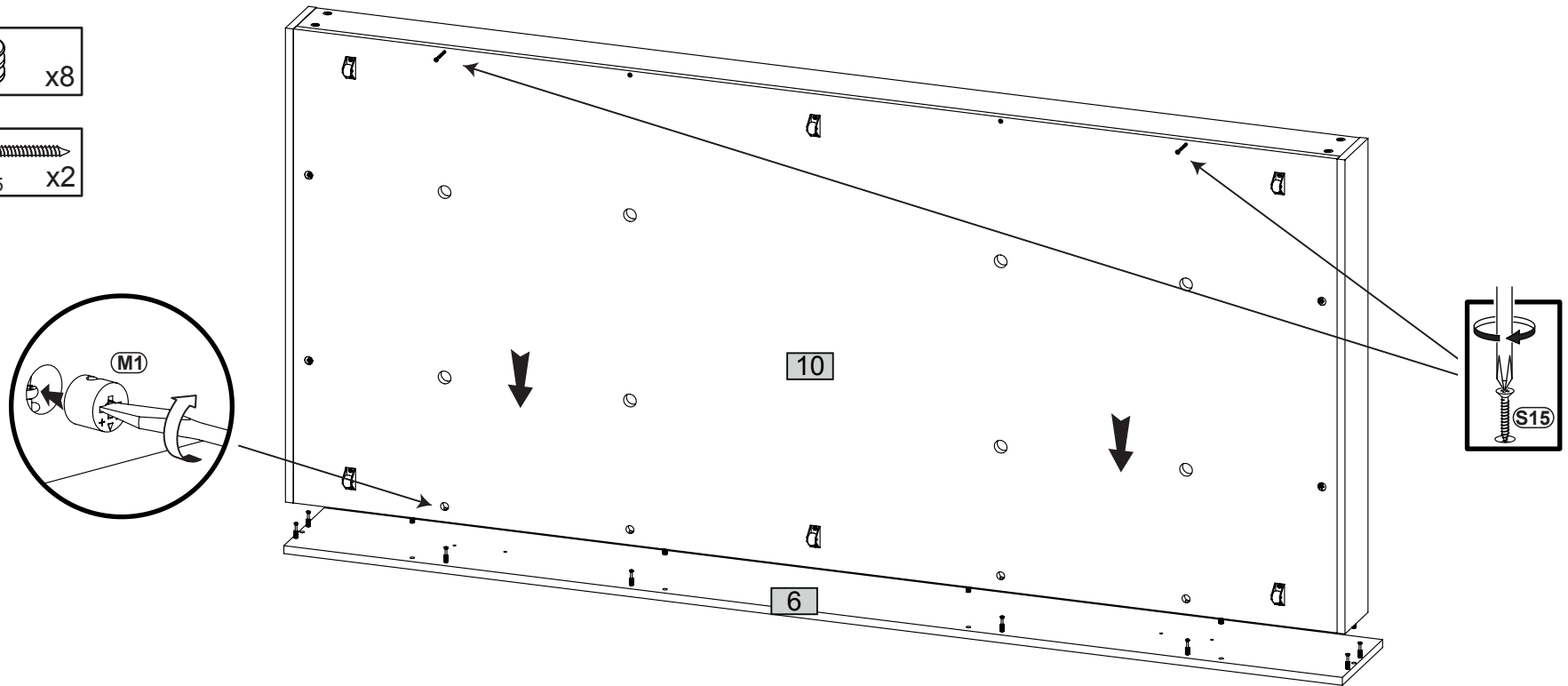
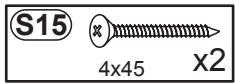

7





8

B1  ϕ 8x28 x20

R11  350 x6

L21  x4

F15  x3

E4  6,0x8 x12

P13  3,5x13 x8

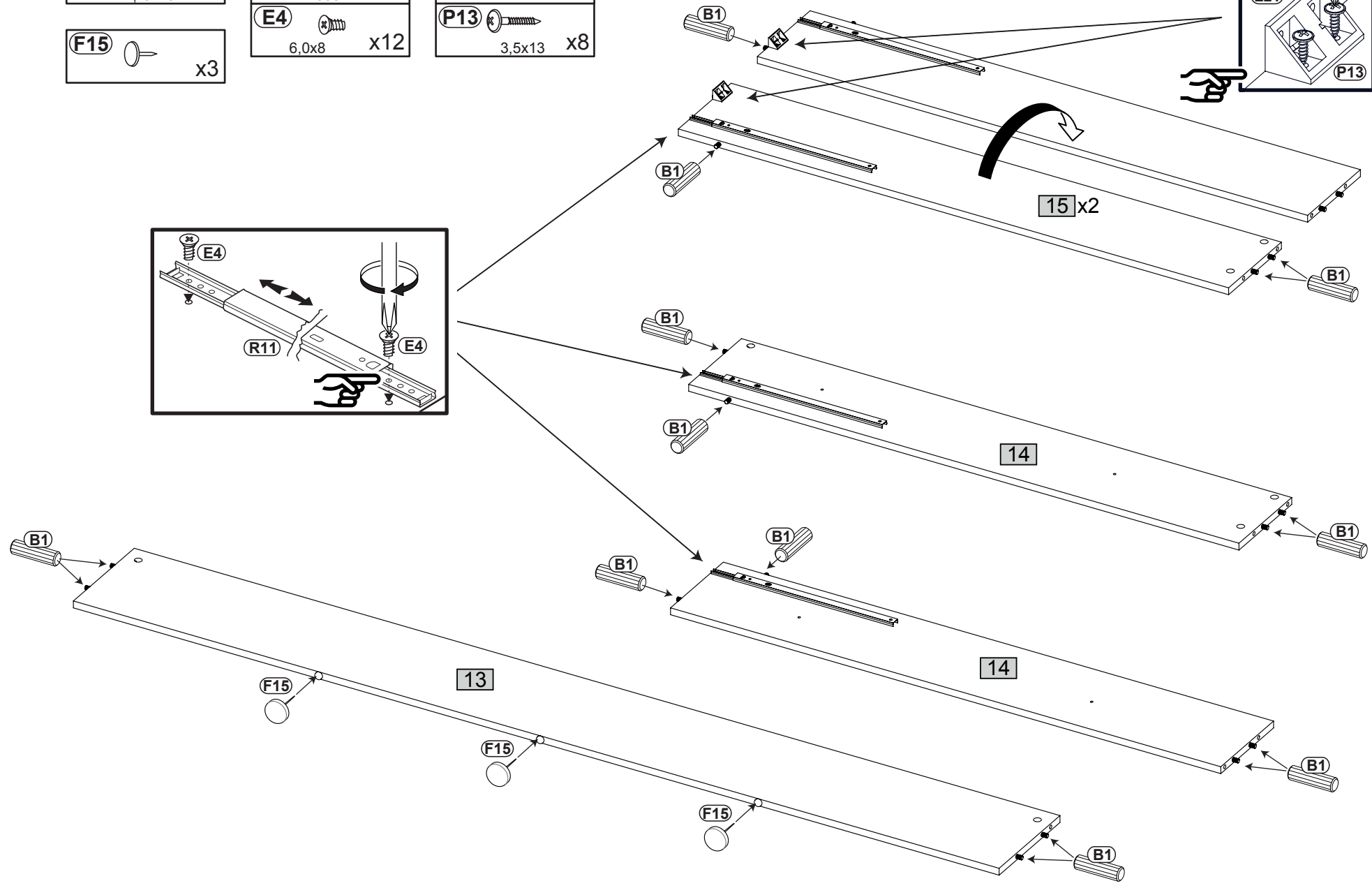
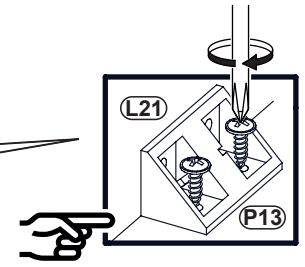
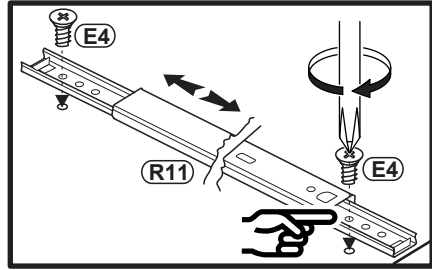

9

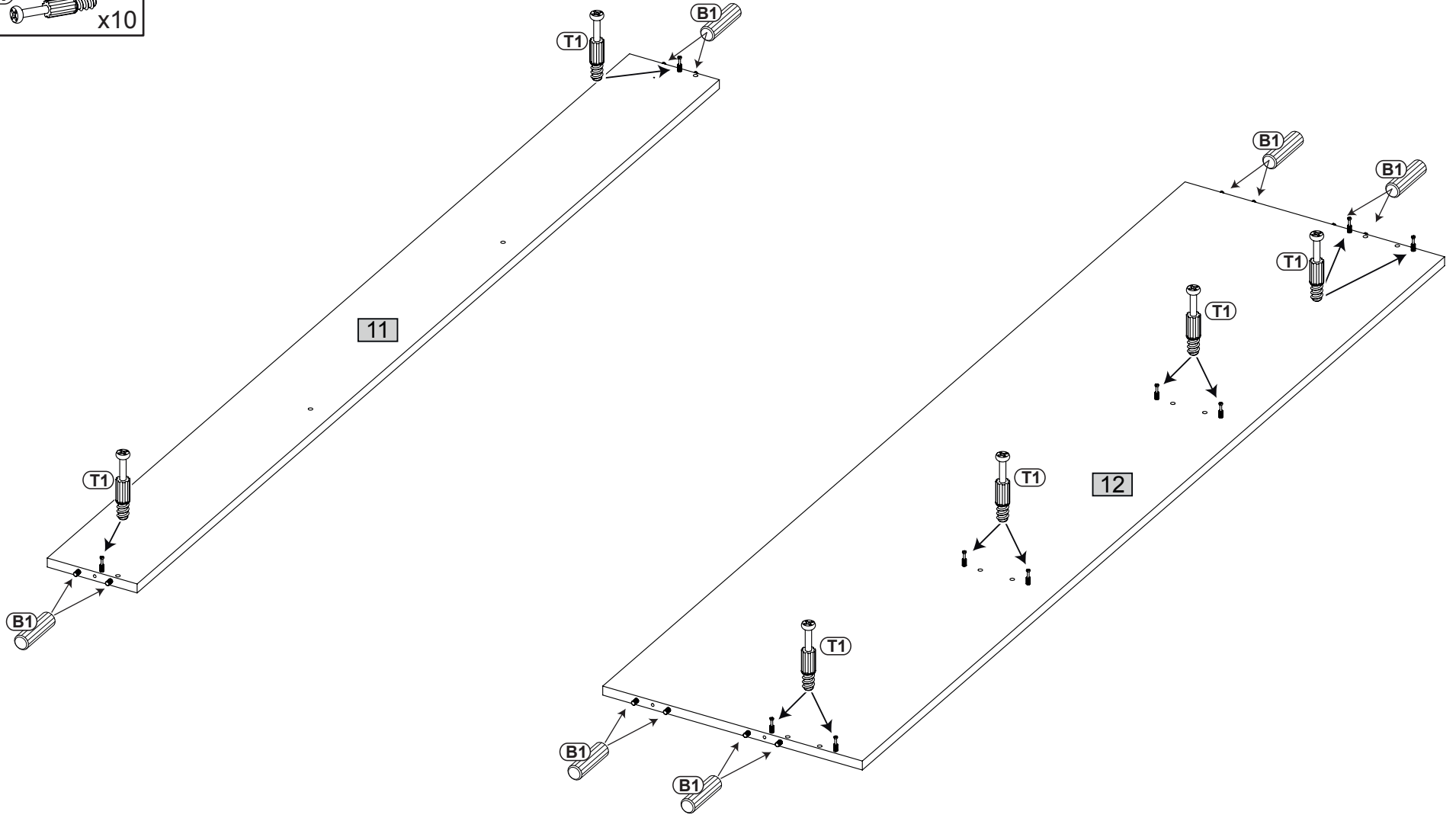
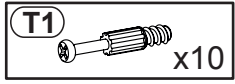
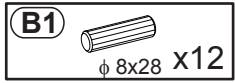

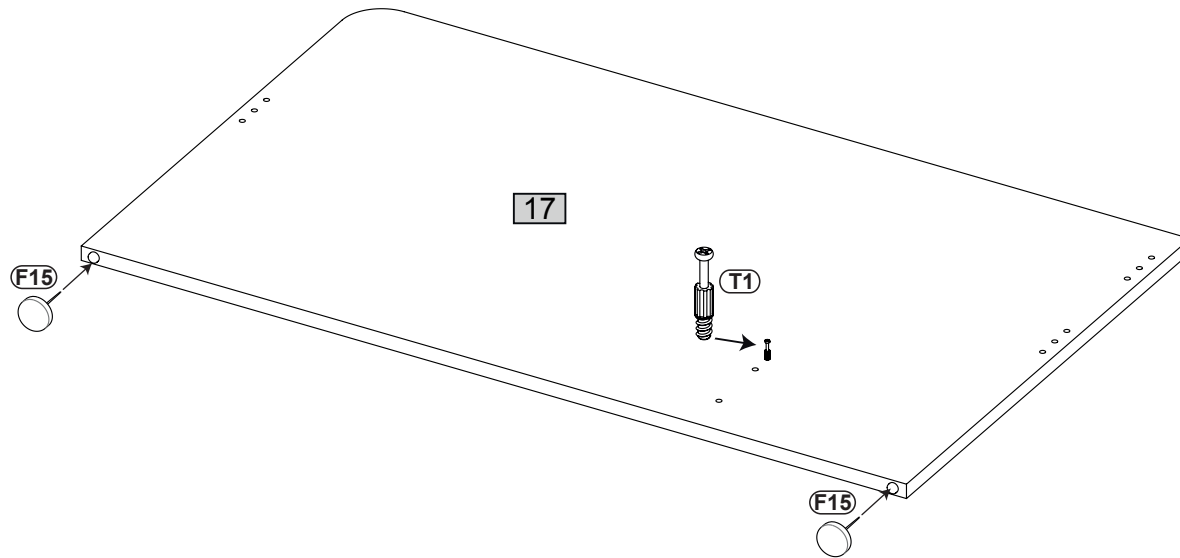
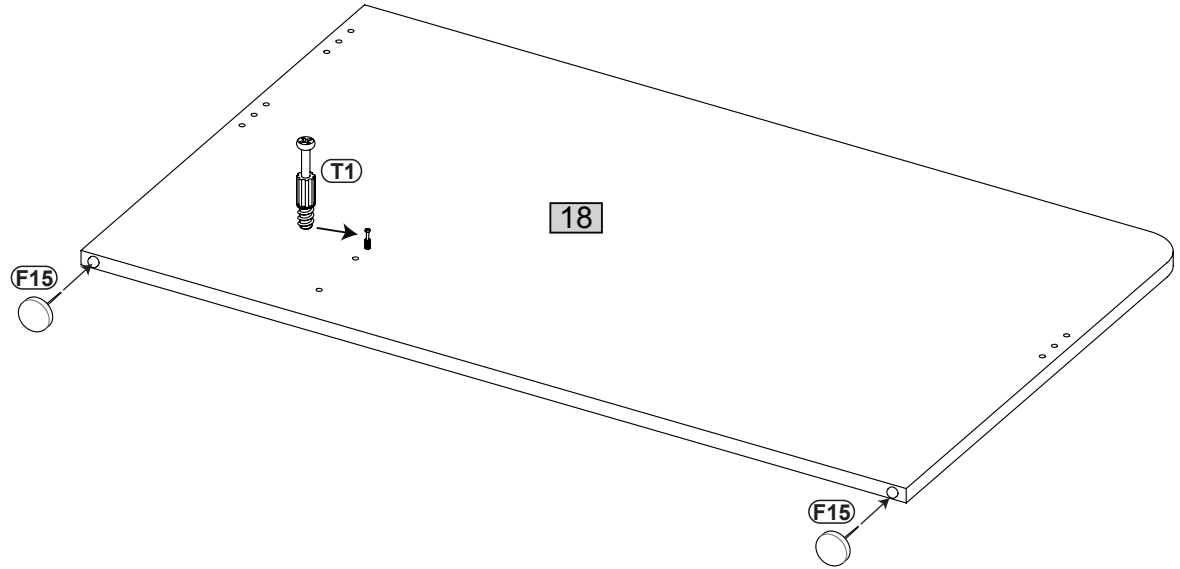
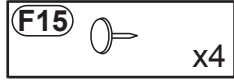
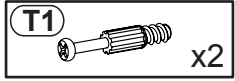

10

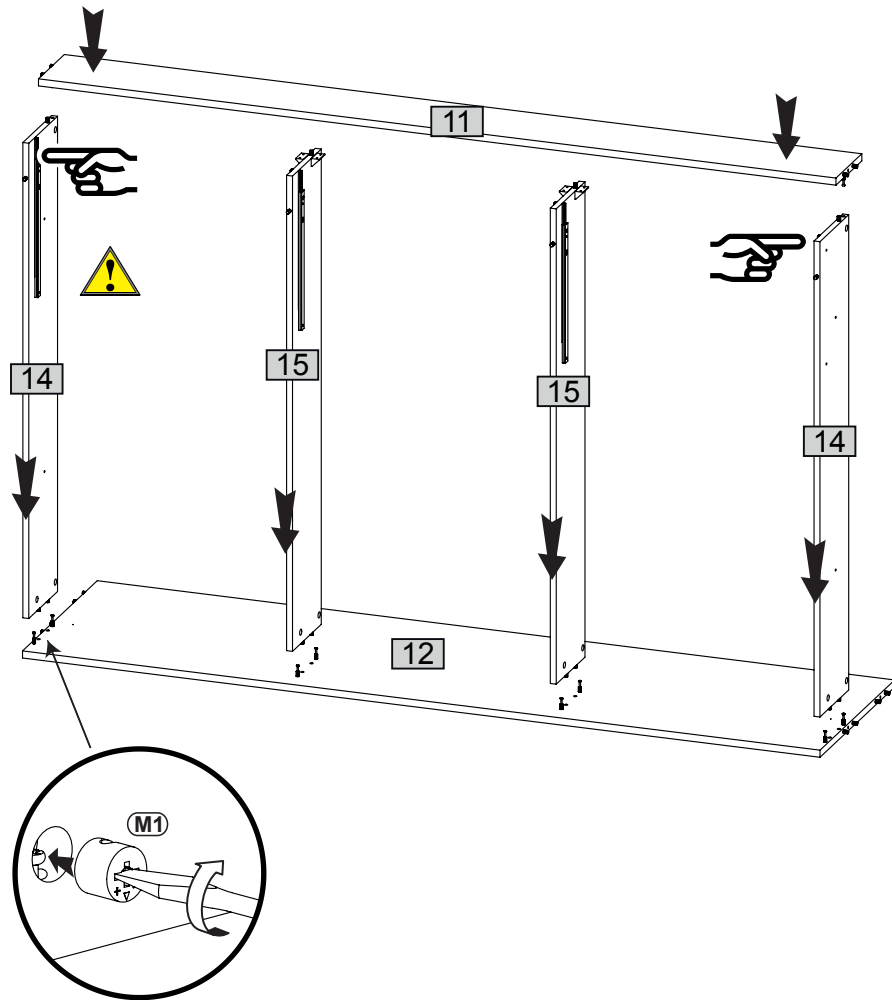

11 **M1**  x10

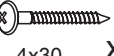

12 **M1**  x2 **K2**  7x70 x6 **P5**  4x30 x4

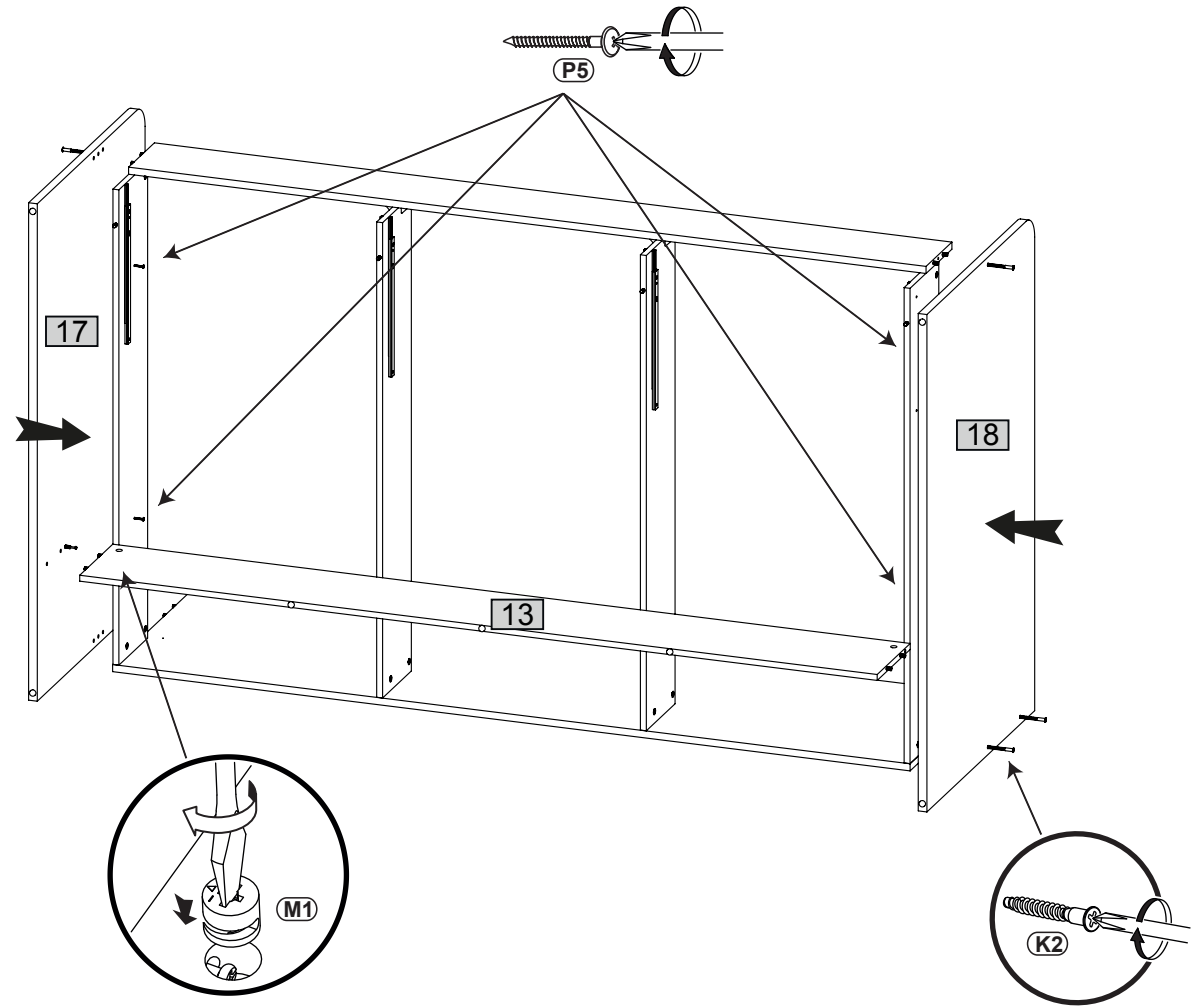

13

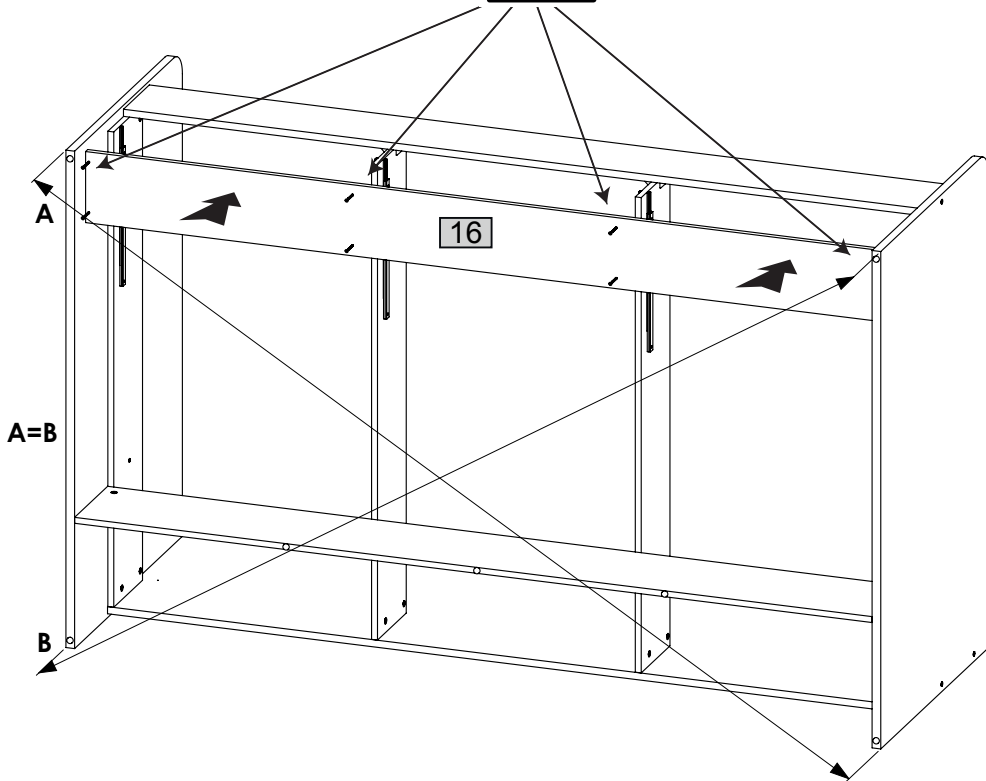
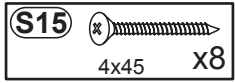

14

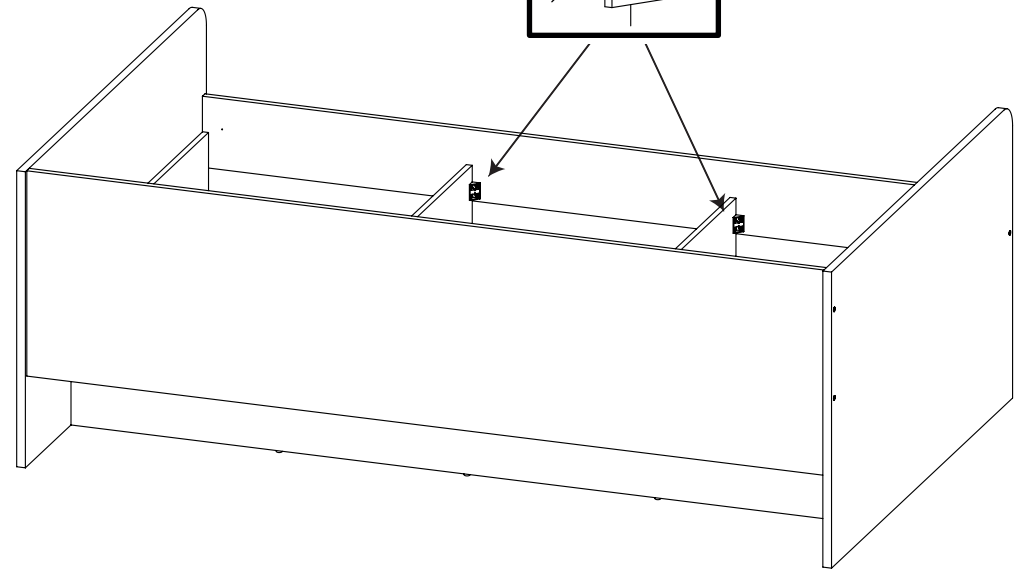
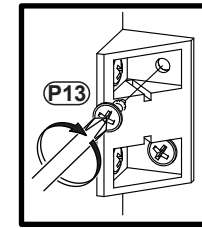
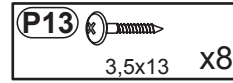

15

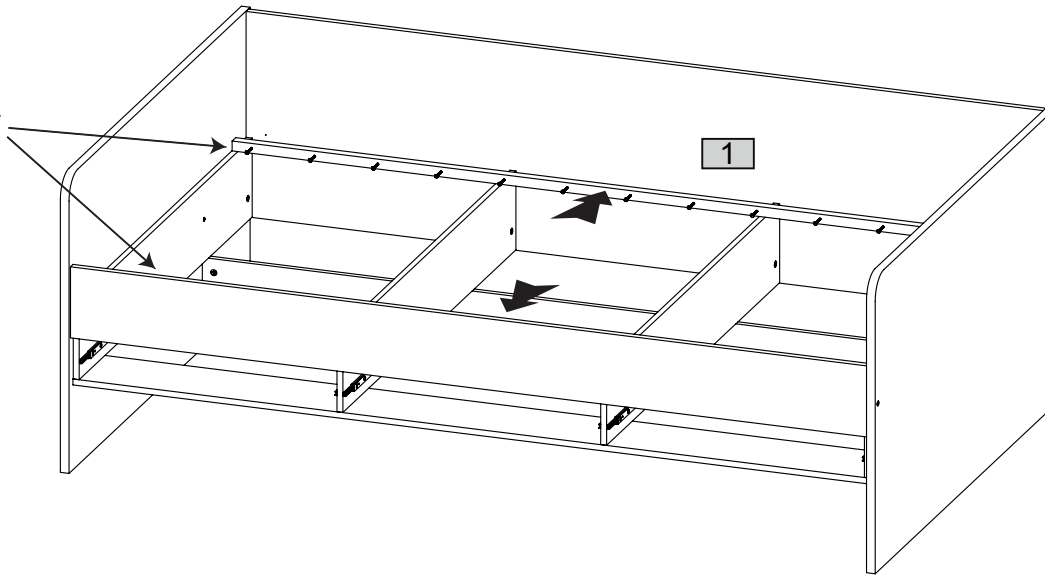
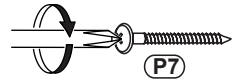
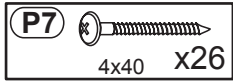

16

