

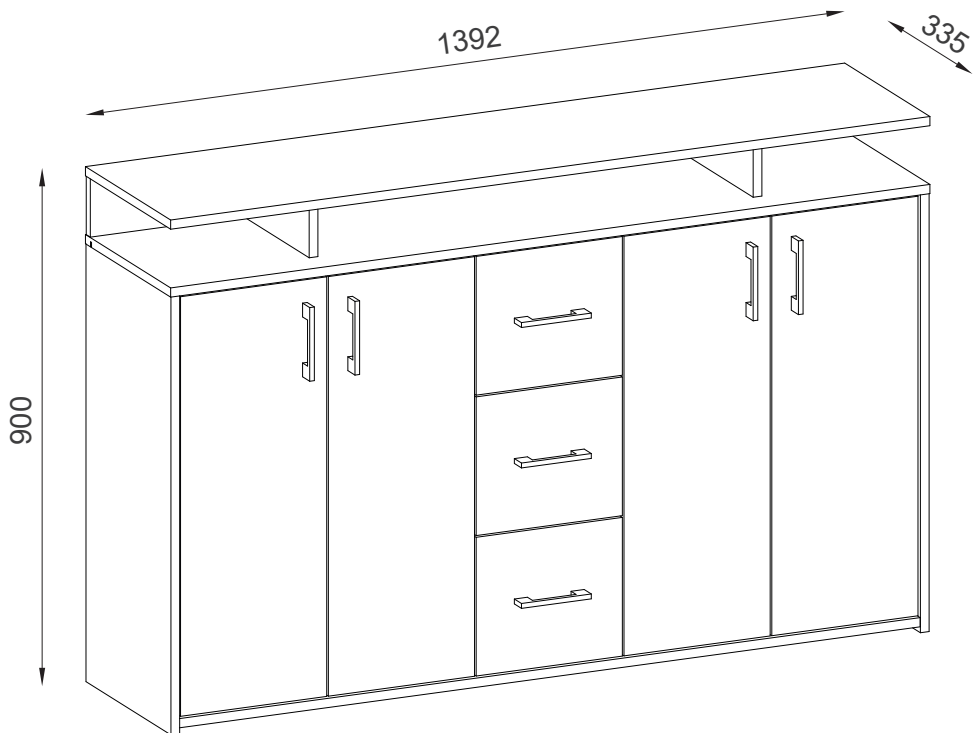

KOMODA DOROTHEA 4150360.xx

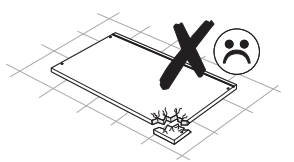

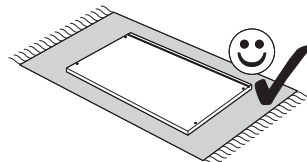

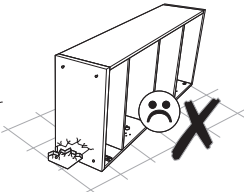
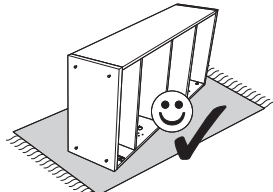
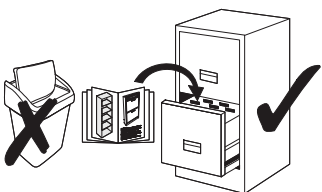
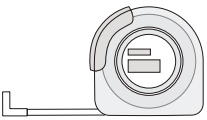
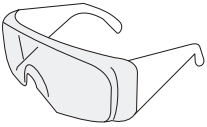
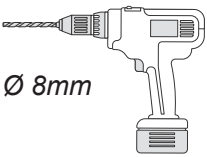
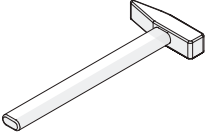
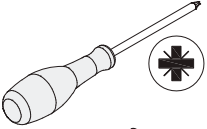
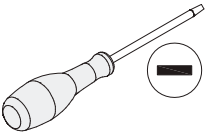
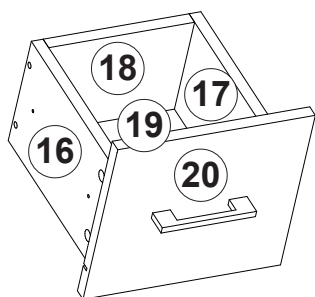
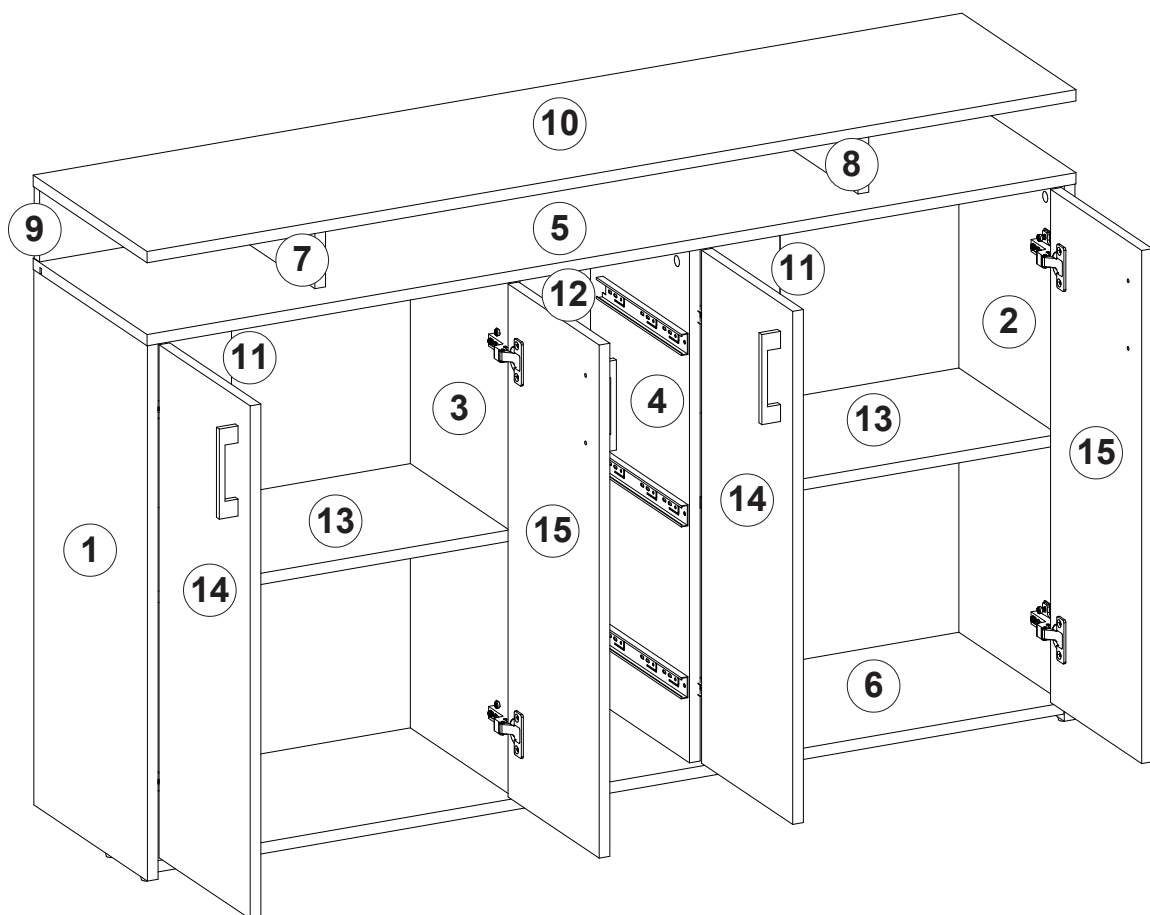
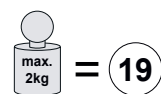
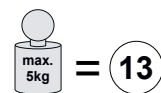
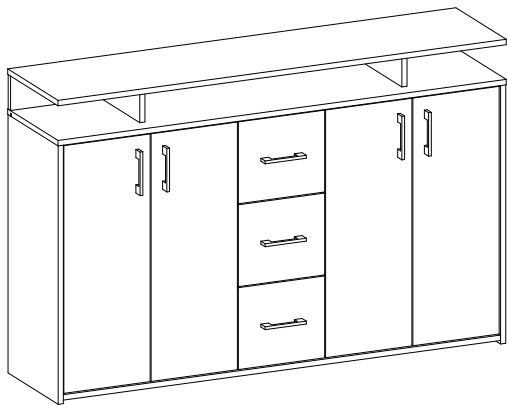



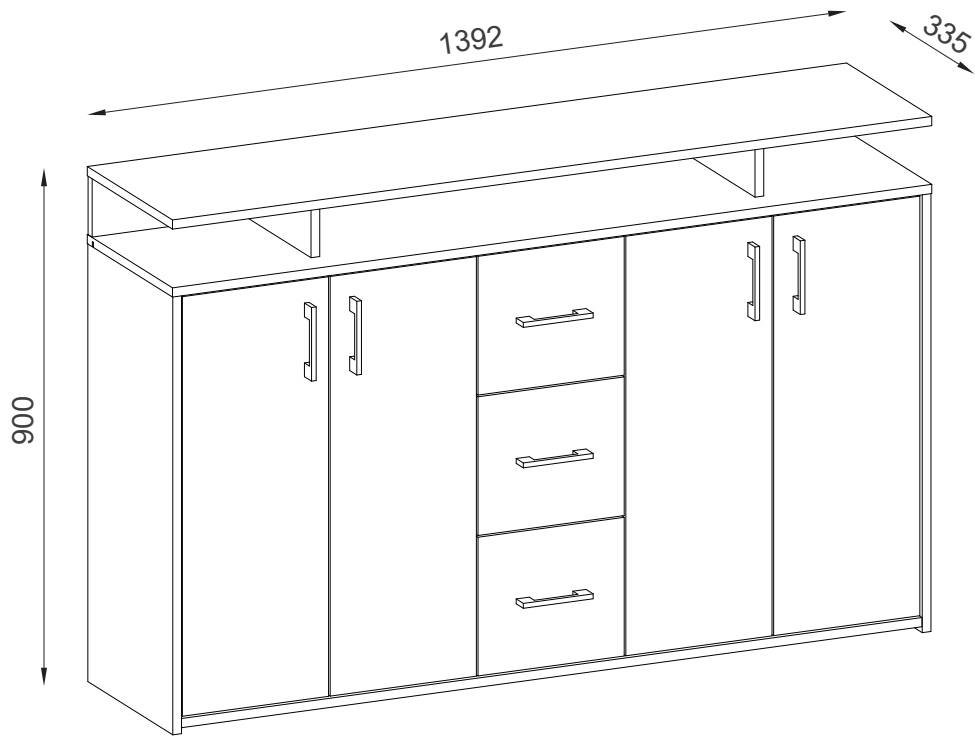

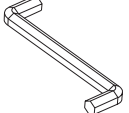
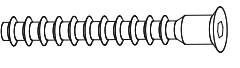

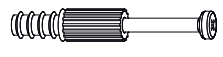

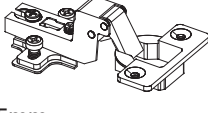
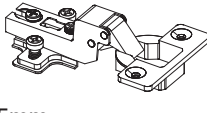
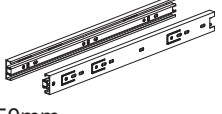
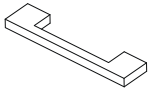



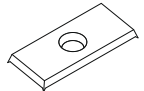
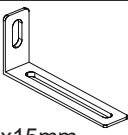
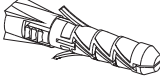



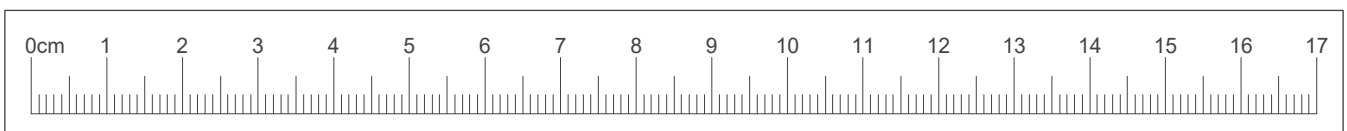

**x3**

A	B (mm)		C	D
1	761	334	16	x1 1/2
2	761	334	16	x1 2/2
3	735	291	16	x1 1/2
4	735	291	16	x1 1/2
5	1392	335	16	x1 2/2
6	1358	309	16	x1 2/2
7	102	260	16	x1 2/2
8	102	260	16	x1 2/2
9	1390	102	16	x1 2/2
10	1392	335	16	x1 2/2
11	756	550	2,5	x2 1/2
12	756	268	16	x1 1/2
13	536	291	16	x2 2/2
14	729	268	16	x2 1/2
15	729	268	16	x2 1/2
16	250	160	16	x3 2/2
17	250	160	16	x3 2/2
18	198	160	16	x3 2/2
19	212	249	2,5	x3 2/2
20	268	241	16	x3 2/2



1x  4mm <b>z1</b>	20x  Ø 6,3x50mm <b>e27</b>	44x  Ø 8x30mm <b>f1</b>	40x  45mm <b>r23</b>
40x  Ø 15x12mm <b>r1</b>	14x  Ø 20mm <b>s1</b>	4x  Ø 35mm <b>ab3</b>	4x  Ø 35mm <b>ab2</b>
3x  L=250mm <b>n2</b>	7x  L=96/128mm <b>c238</b>	2x  15x45x45mm <b>k46</b>	4x  Ø 15mm <b>k40</b>
11x  10x10x15mm <b>l2</b>	6x  L=20x10x2 mm <b>n108</b>	2x  L=75x32x15mm <b>n14/2</b>	2x  Ø 8x50mm <b>y1</b>
18x  Ø 3x16mm <b>p50</b>	20x  Ø 3,5x16mm <b>p51</b>	14x  Ø 4,2x16mm <b>p21</b>	14x  Ø 4x27mm <b>p28</b>
12x  Ø 5x13 mm <b>e3</b>	2x  Ø 5x50mm <b>p60</b>		

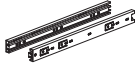

<b>1</b>	f1 x 8  Ø 8x30mm	r1 x 4  Ø 15x12mm	r23 x 4  45mm	b2 x 4  40x50x12mm	e3 x 12  Ø 5x13mm	n2 x 3  L=250mm
----------	---	--	--	---	--	--

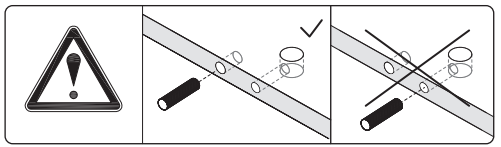
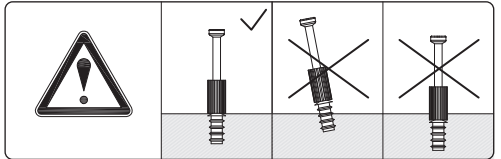
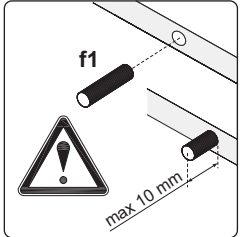
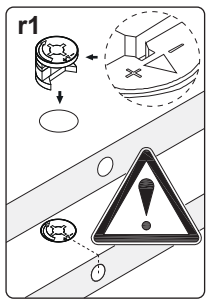
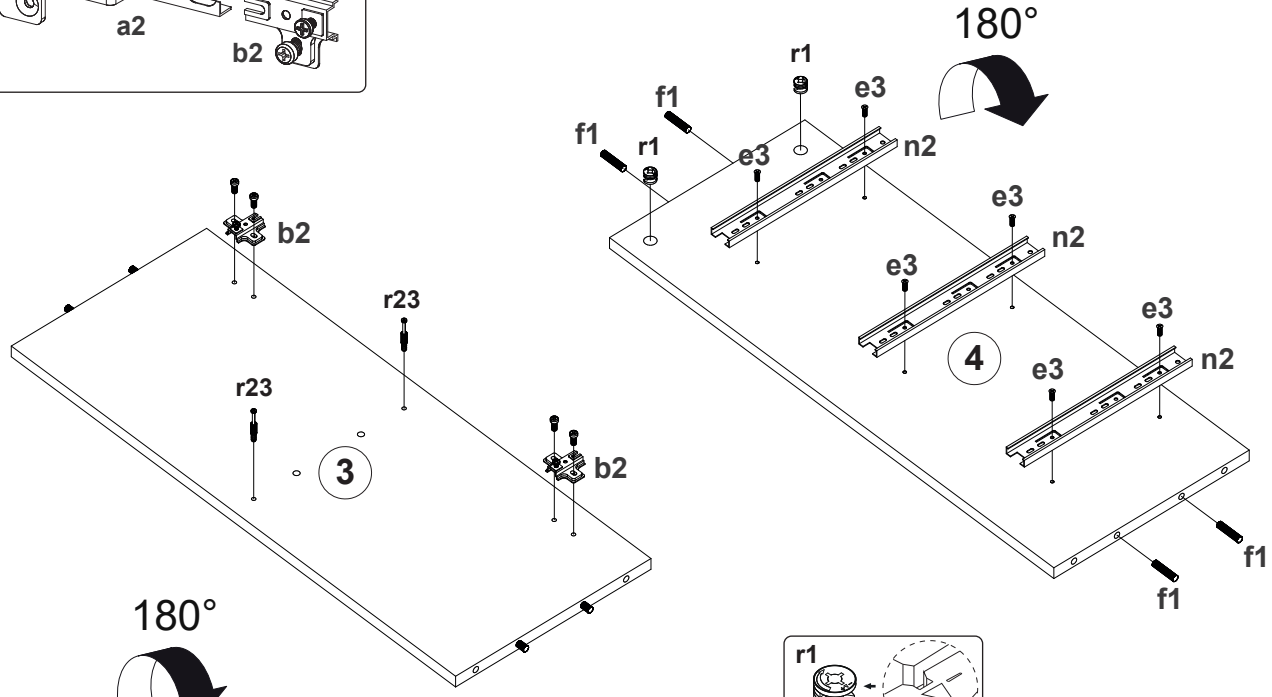
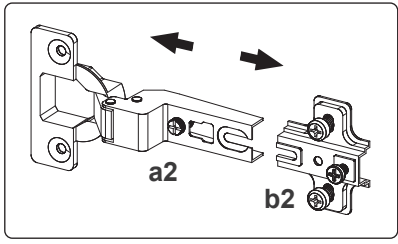
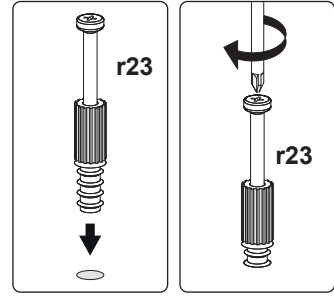
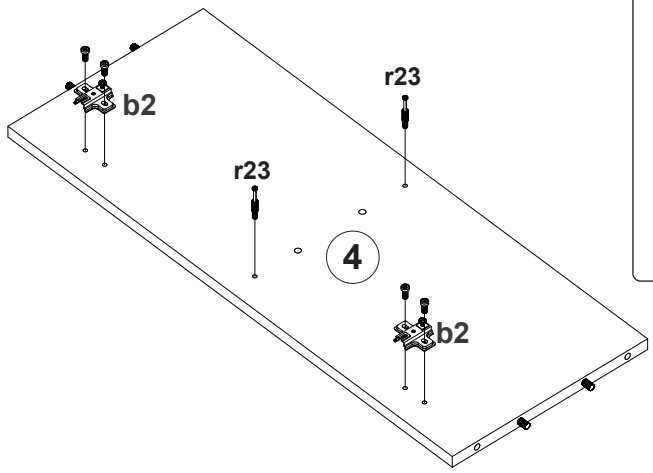
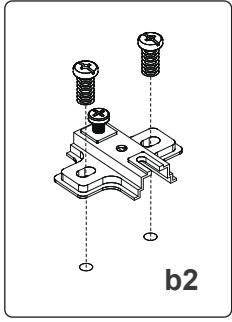

# 2

f1 x 12



Ø 8x30mm

r1 x 6



Ø 15x12mm

r23 x 8



45mm

b3 x 4



40x50x12mm

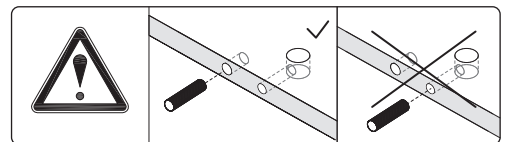
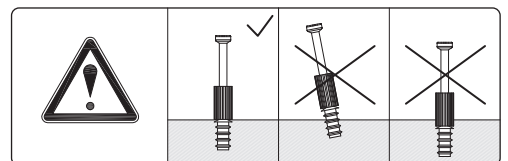
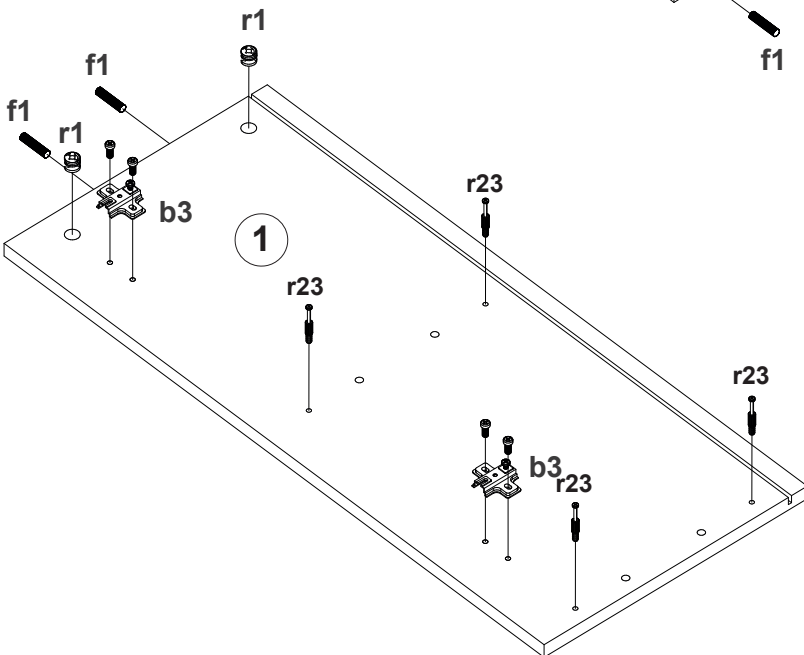
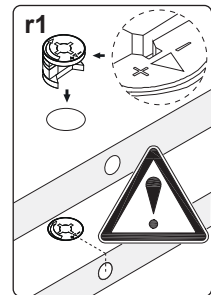
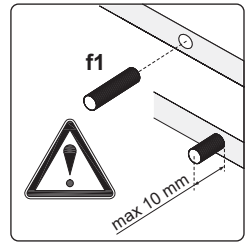
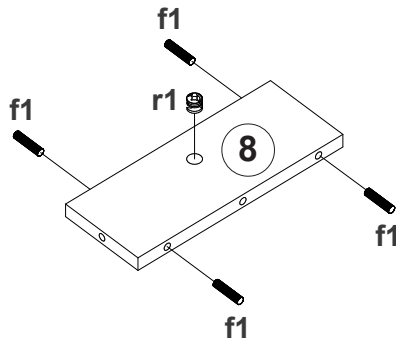
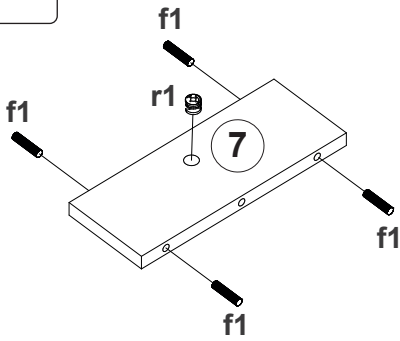
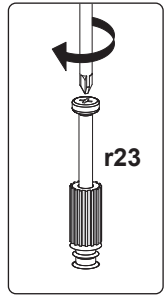
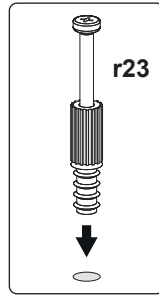
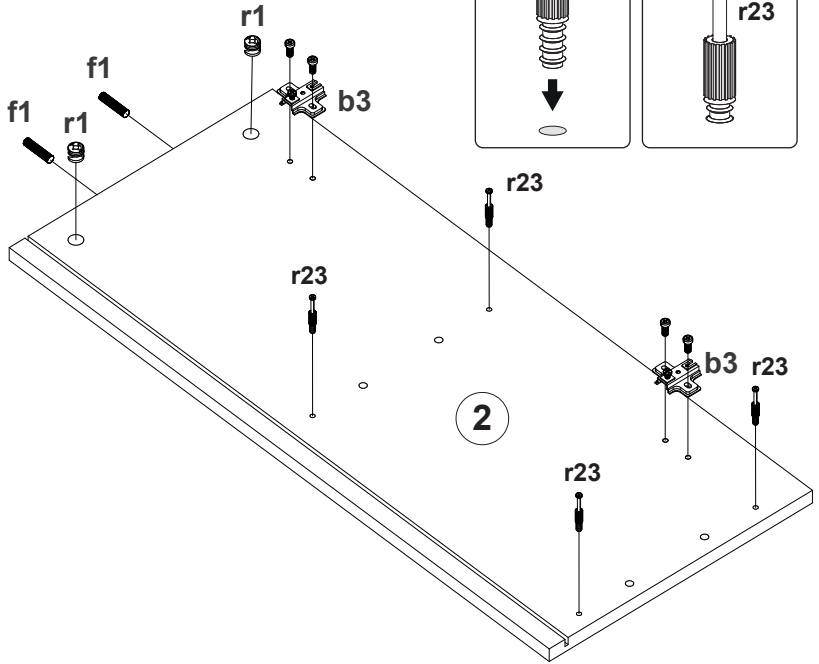
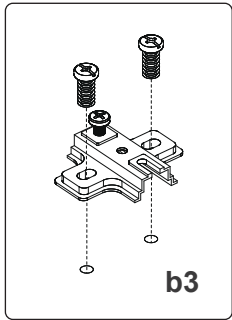
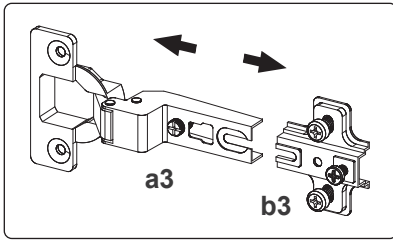

# 3

f1 x 8



Ø 8x30mm

r1 x 8



Ø 15x12mm

r23 x 11



45mm

p51 x 4



Ø 3,5x16mm

n14/2 x 2

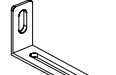

L=75x32x15mm

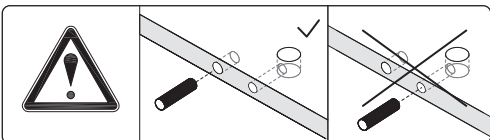
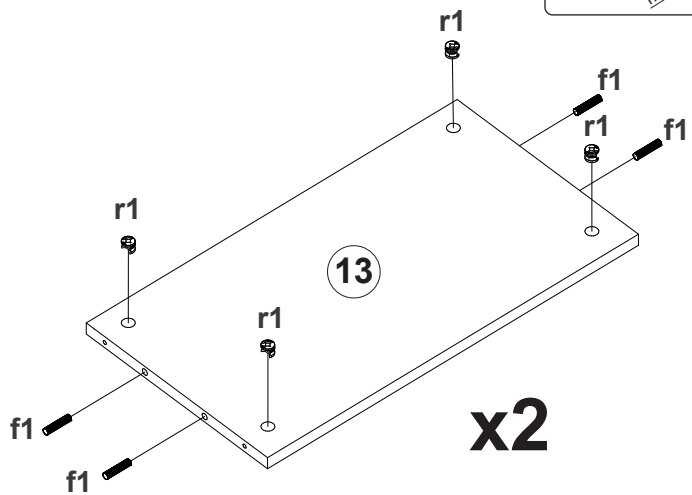
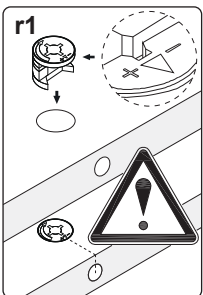
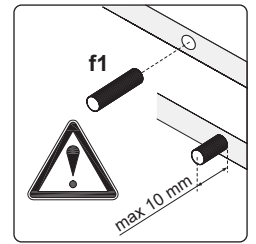
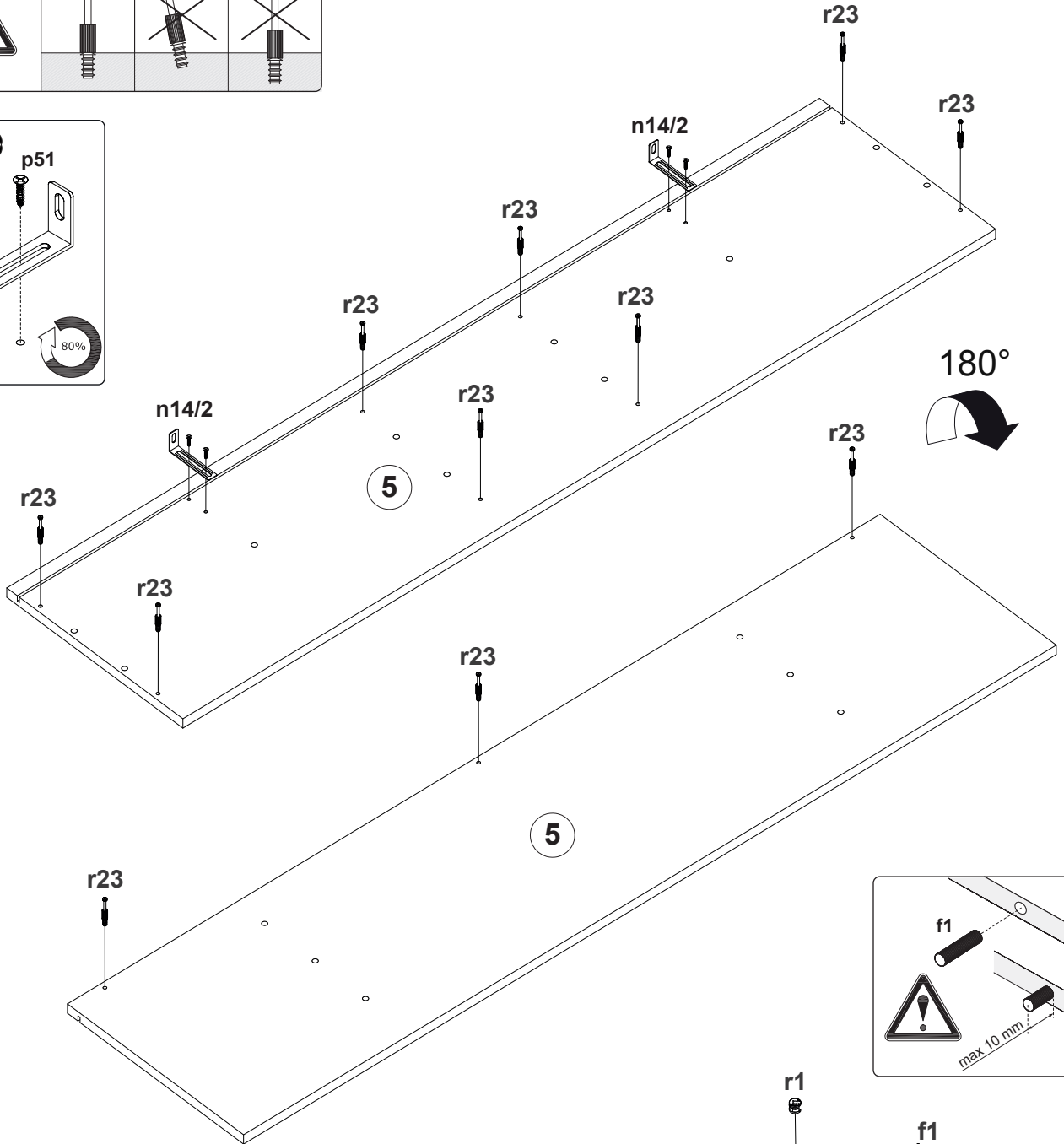
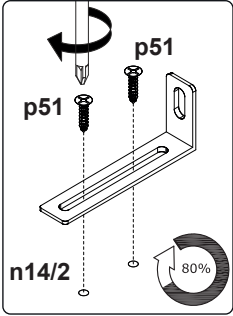
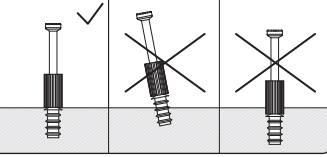

# 4

f1 x 4



Ø 8x30mm

r1 x 10



Ø 15x12mm

r23 x 5



45mm

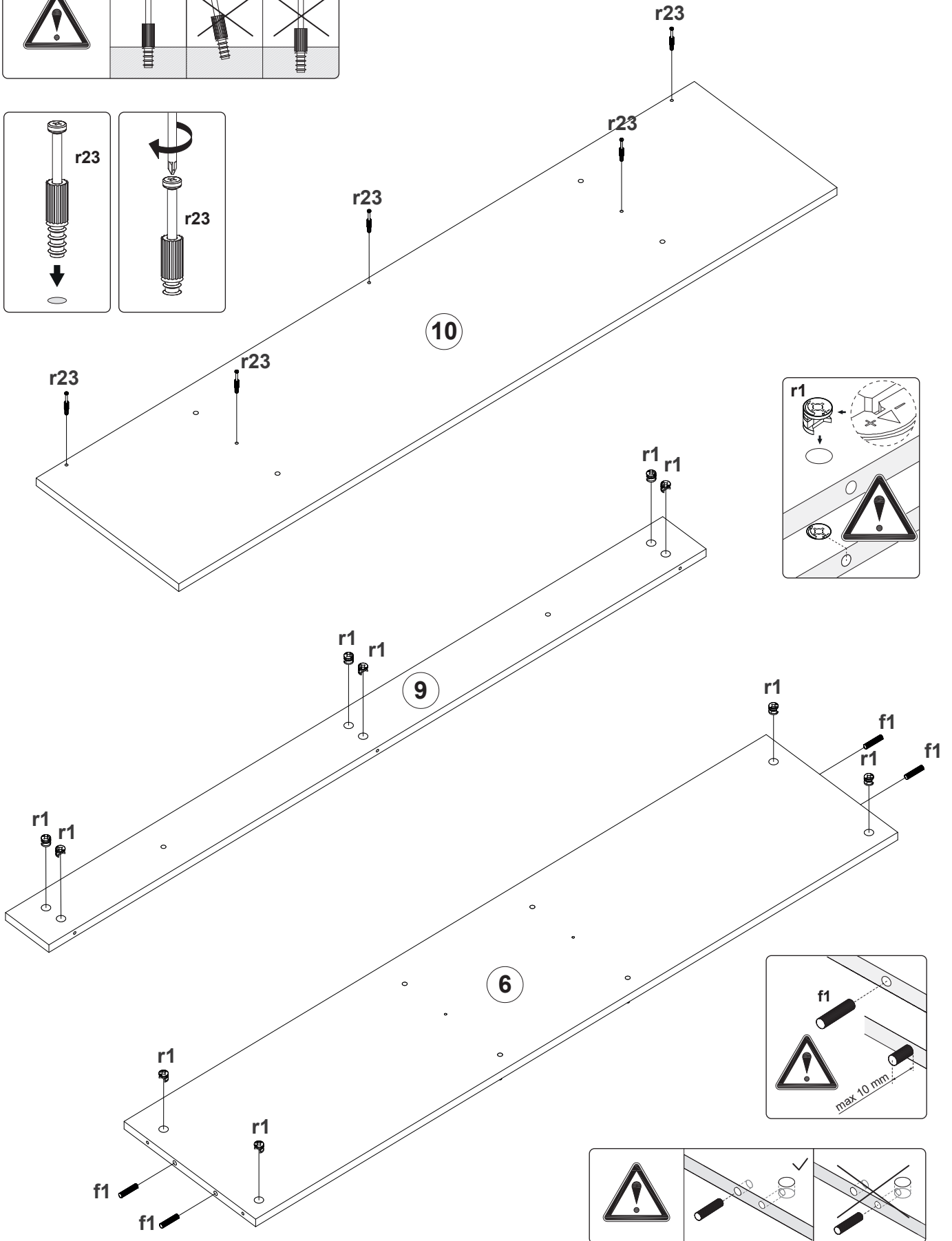
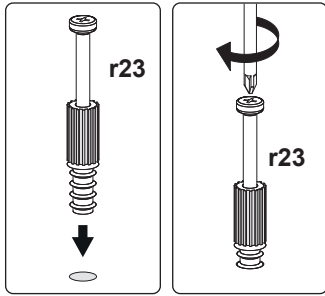
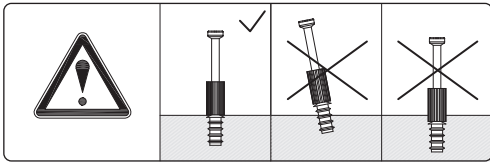

# 5

s1 x 4



Ø 20mm

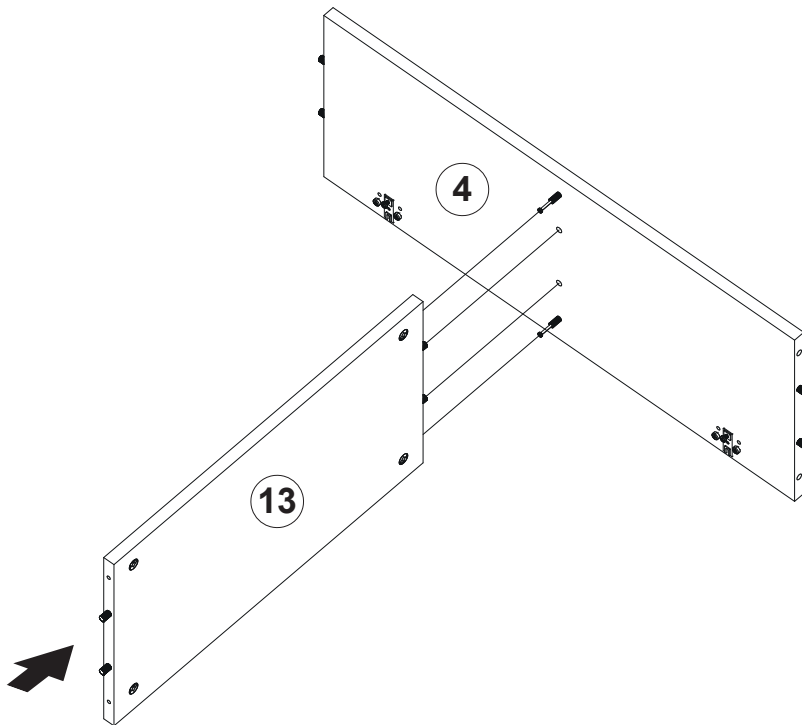
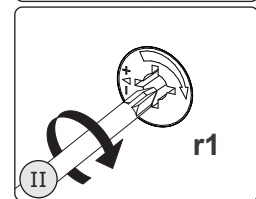
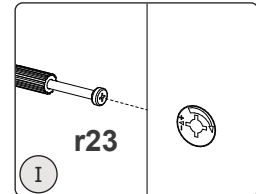
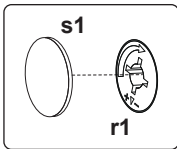
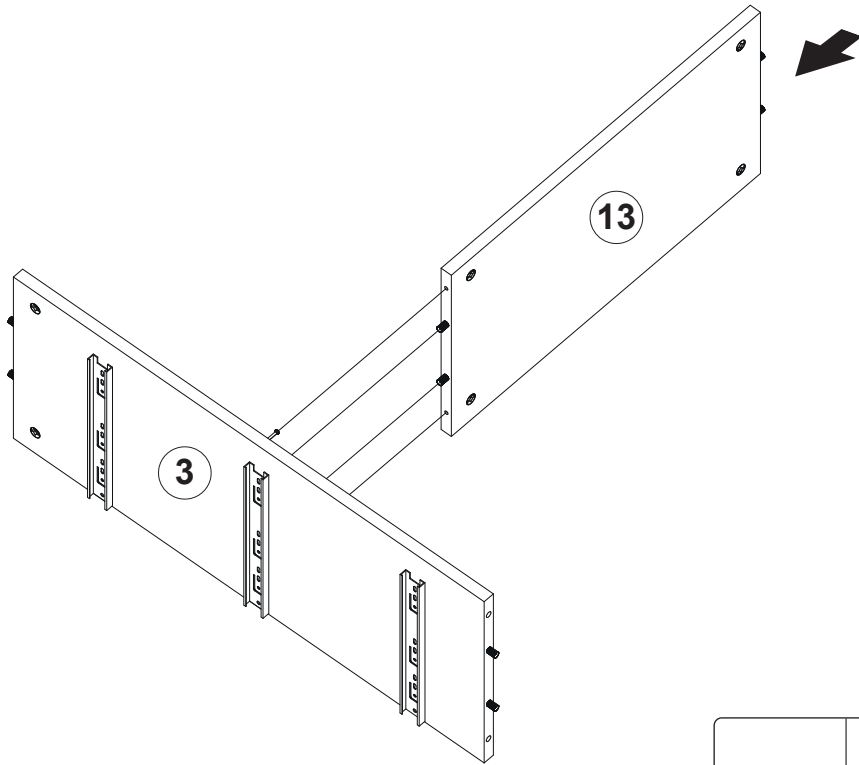

6

z1 x 1



4mm

e27 x 2

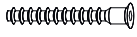

Ø 6,3x50mm

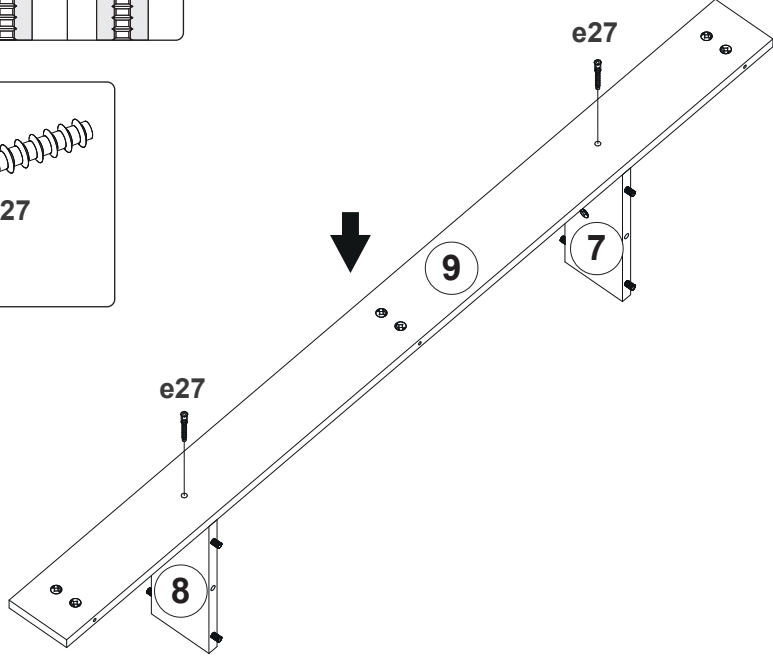
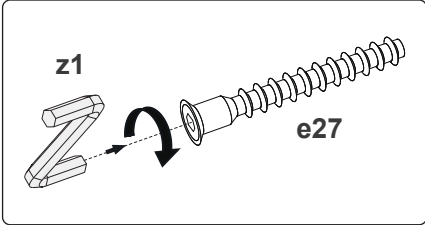
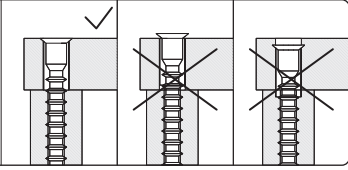

I

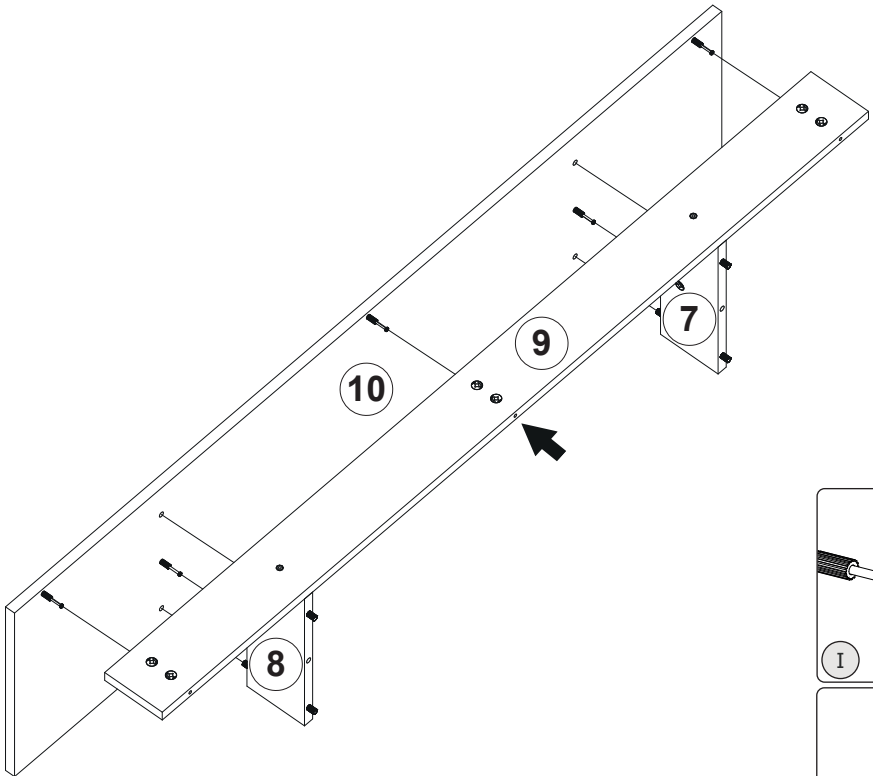

II

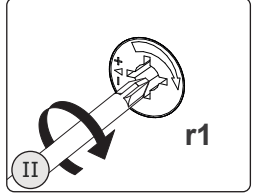
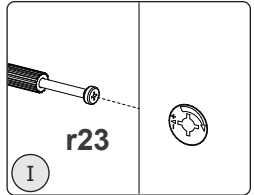

# 7

z1 x 1

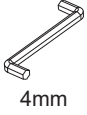

4mm

e27 x 4



Ø 6,3x50mm

s1 x 4



Ø 20mm

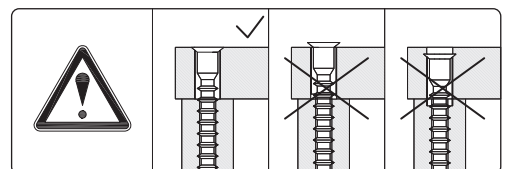
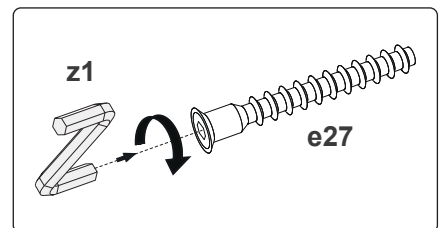
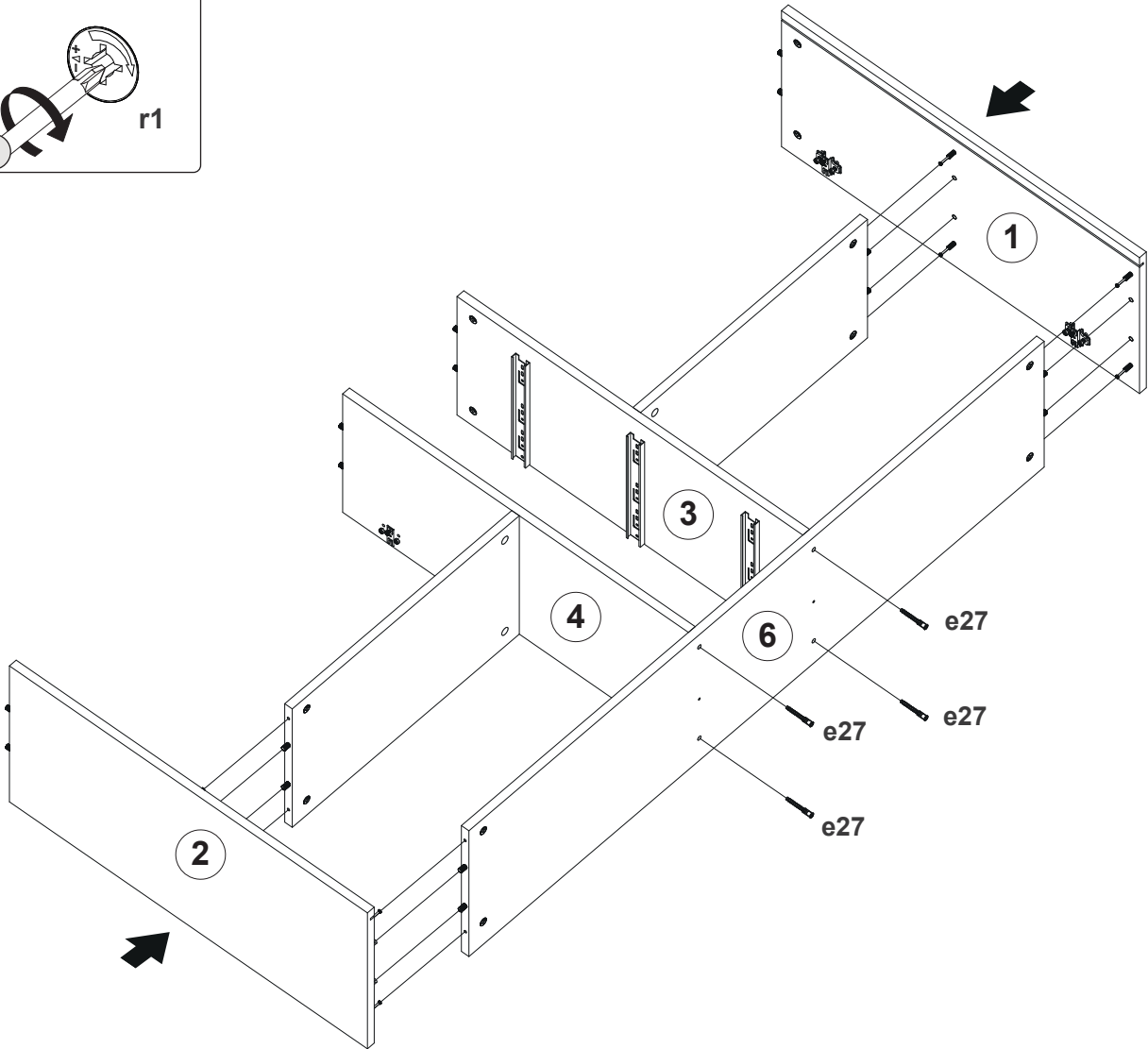
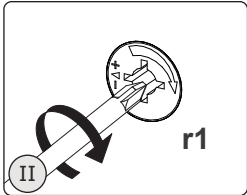
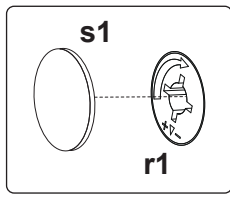
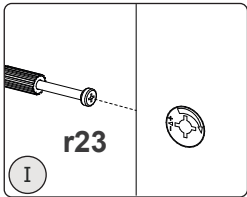

# 8

s1 x 4



Ø 20mm

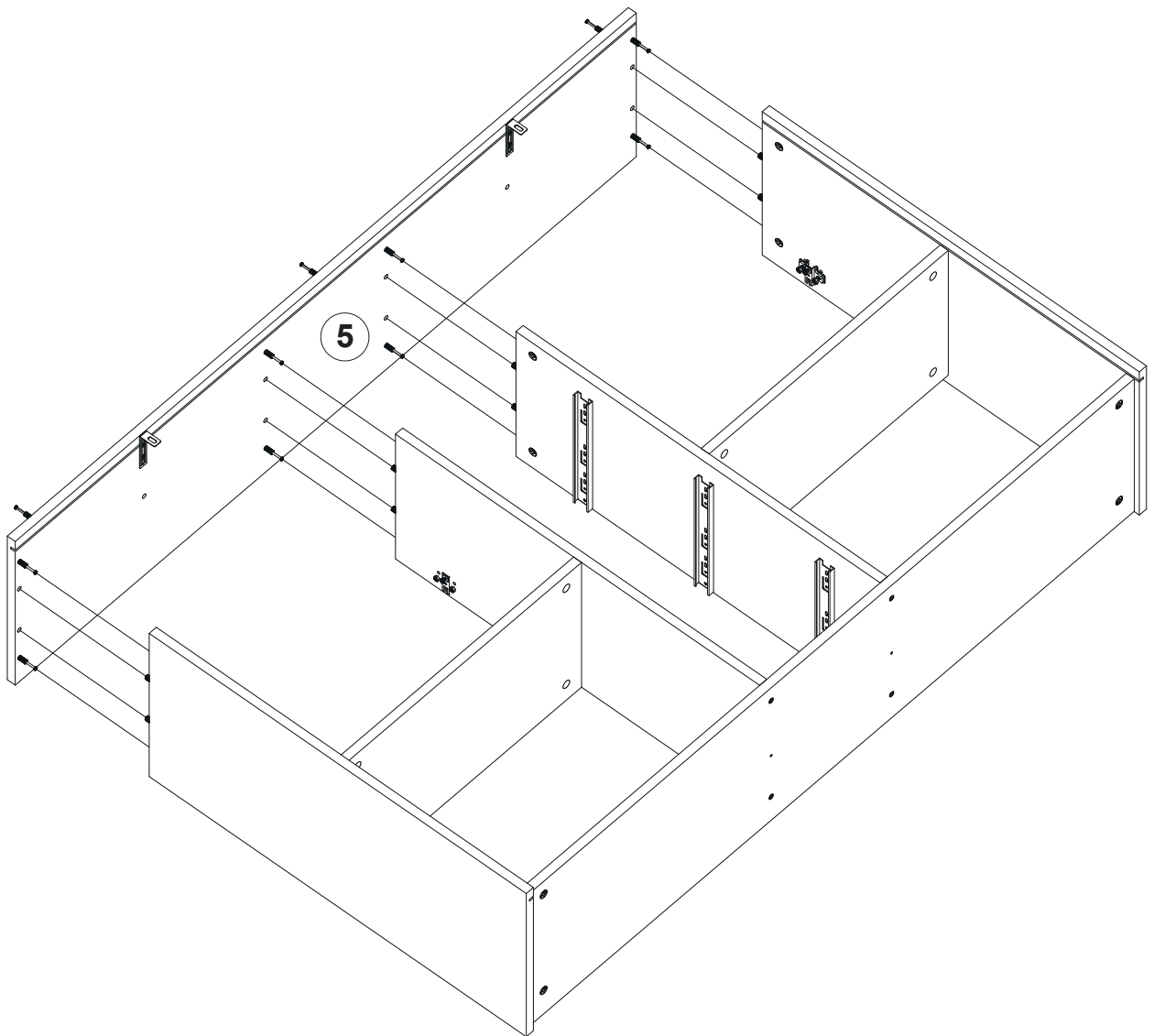
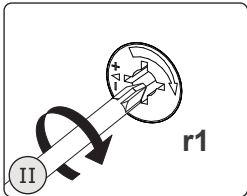
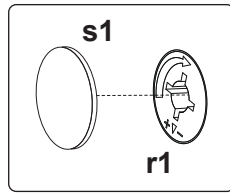
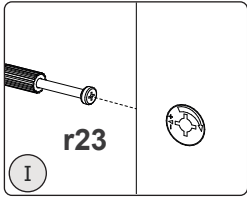

# 9

s1 x 2



Ø 20mm

z1 x 1



4mm

e27 x 2

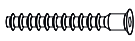

Ø 6,3x50mm

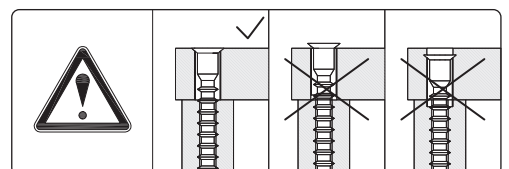
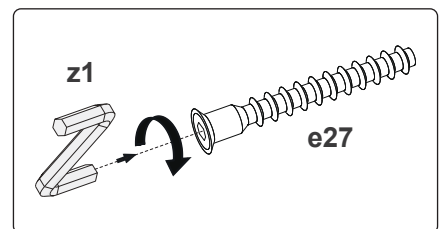
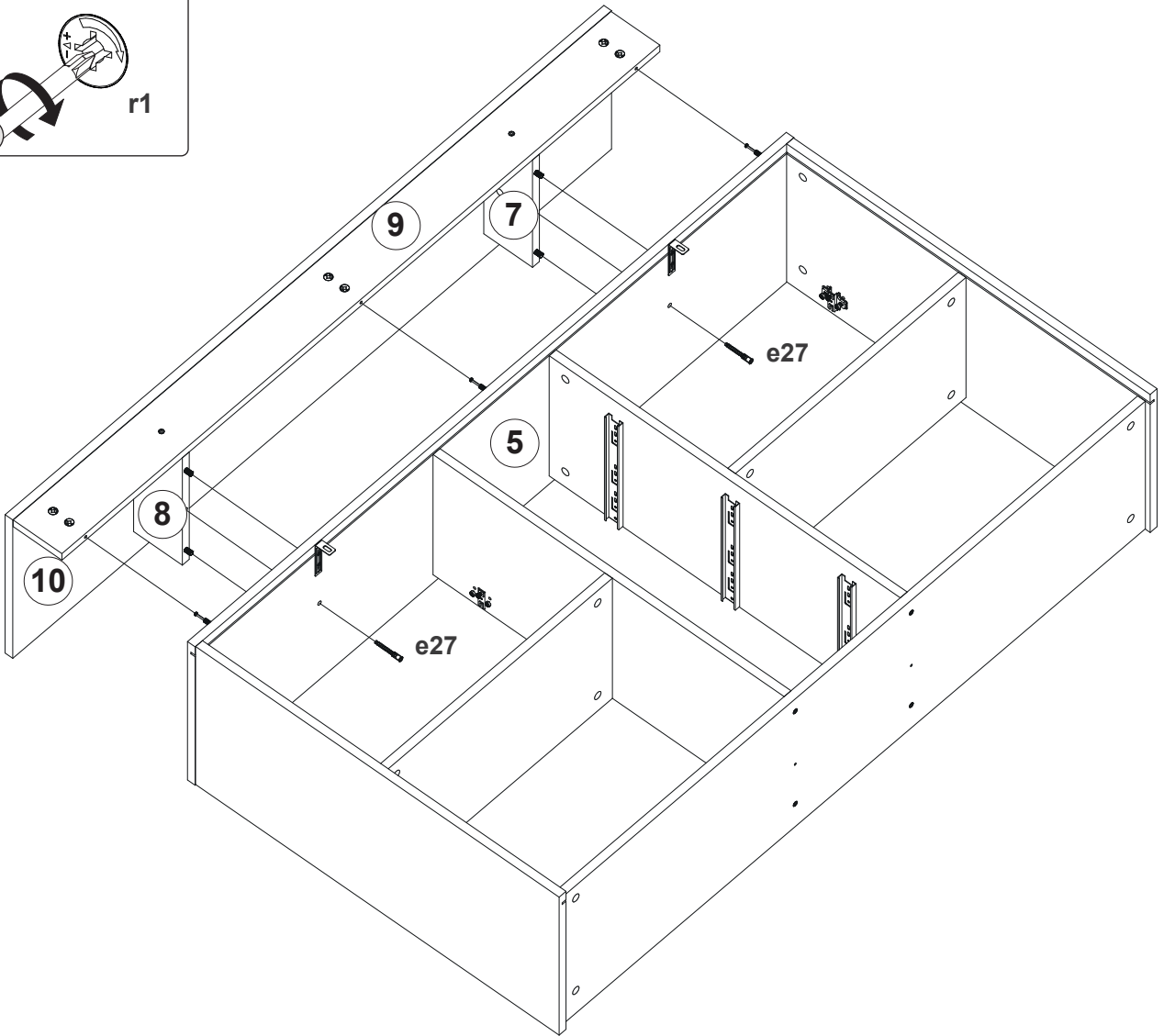
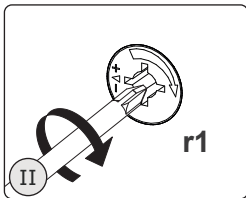
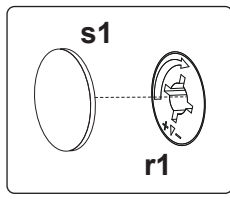
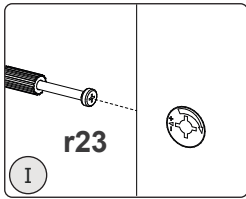

10

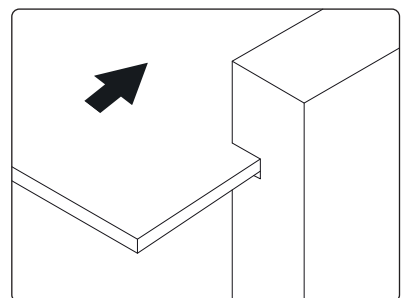
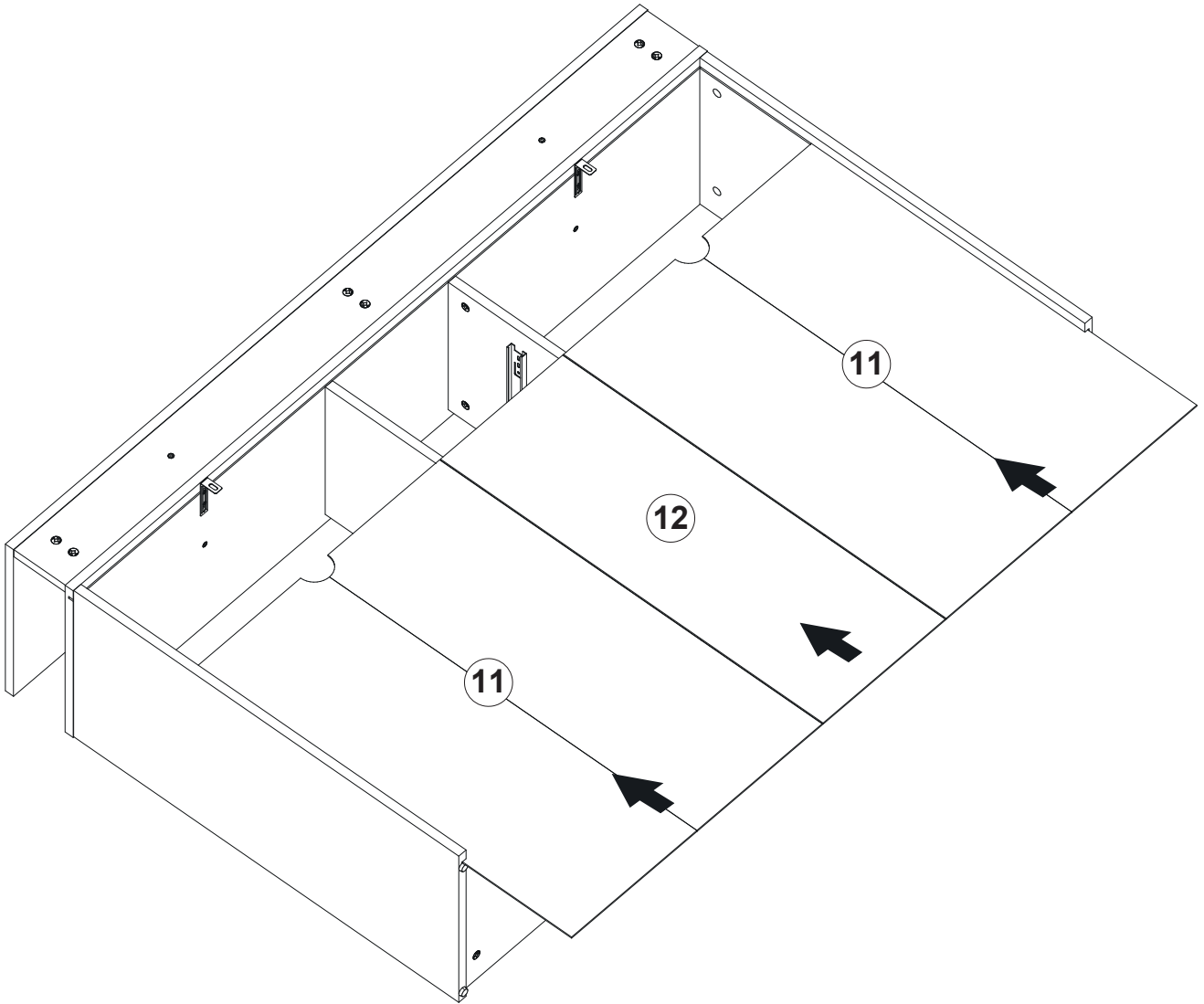

# 11

I2 x 11

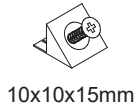

p21 x 11

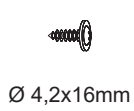

k40 x 4



k46 x 2

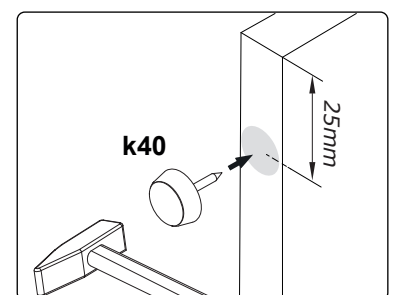
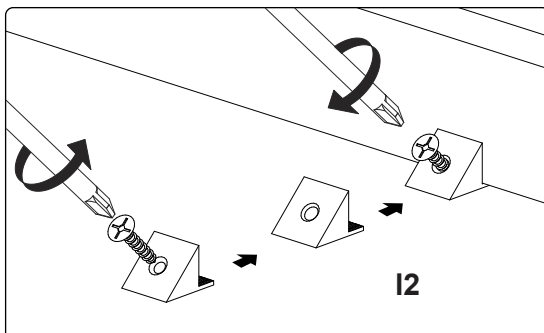
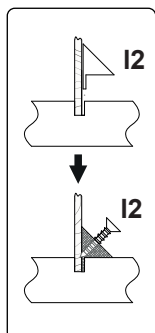
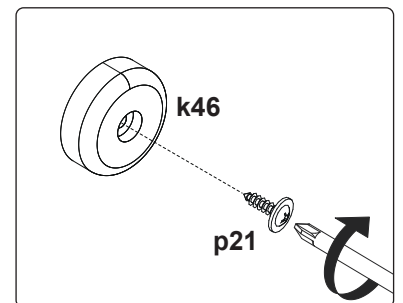
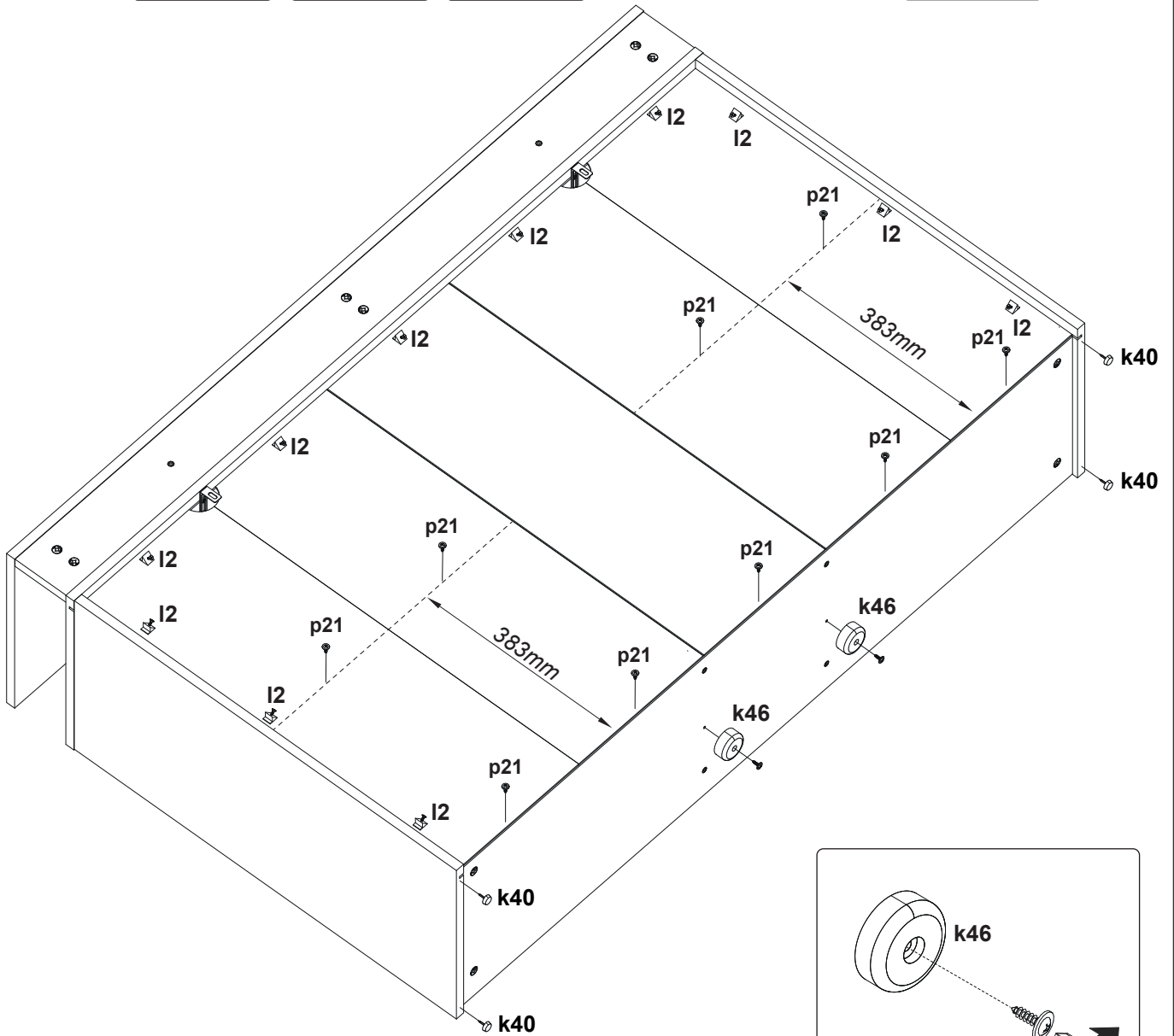
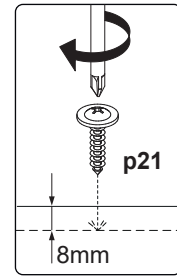
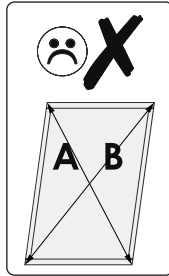
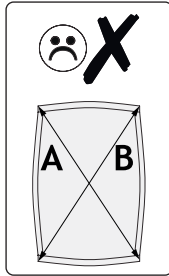
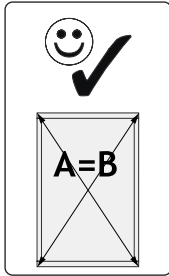
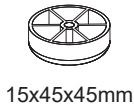

# 12

f1 x 12



Ø 8x30mm

r1 x 12



Ø 15x12mm

r23 x 12



45mm

z1 x 1



4mm

e27 x 12

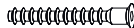

Ø 6,3x50mm

c238 x 3

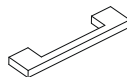

L=96/128mm

p28 x 6



Ø 4x27mm

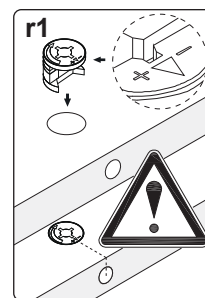
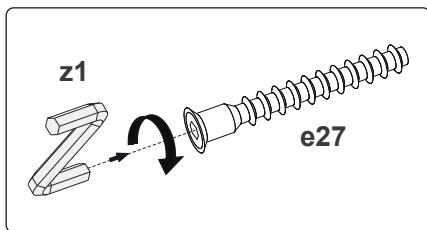

## A

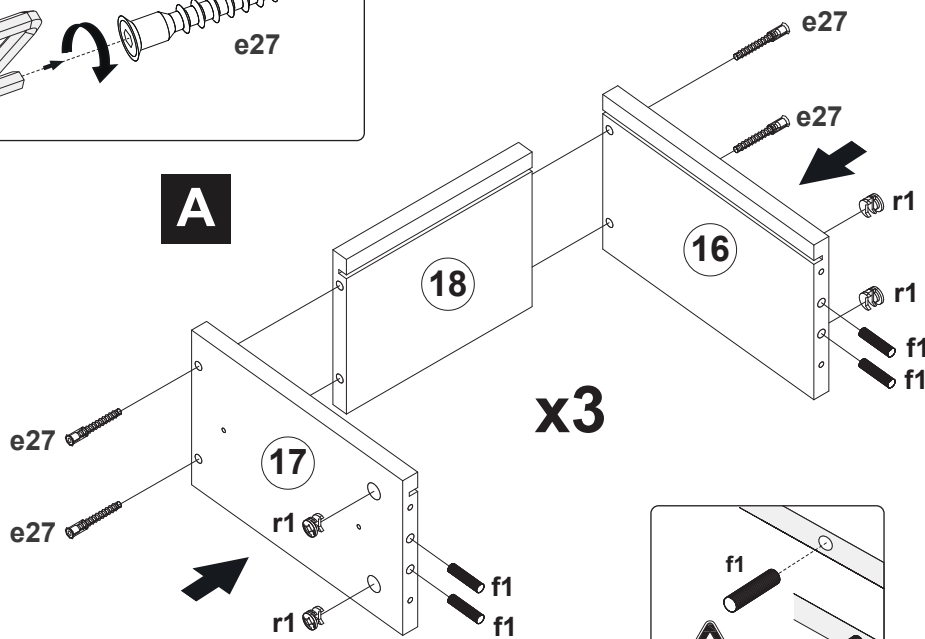

x3

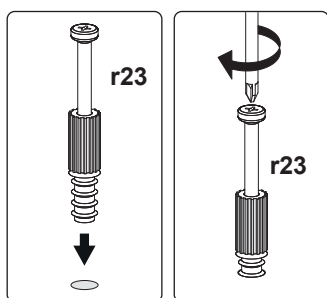

## B

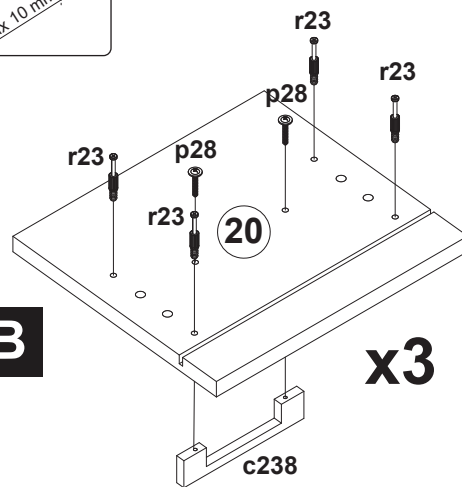

x3

## C

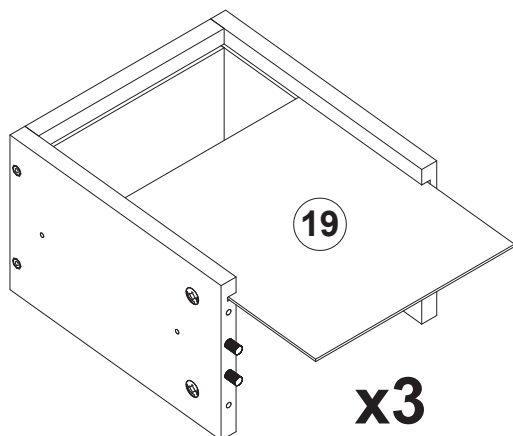

x3

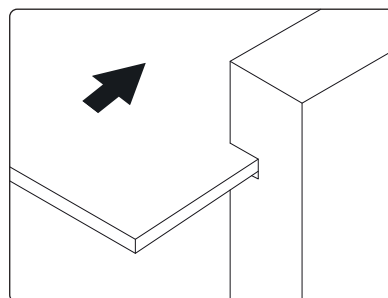

# 13

p50 x 12



Ø 3x16mm

n2 x 3

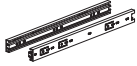

L=250mm

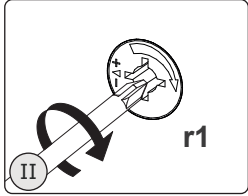
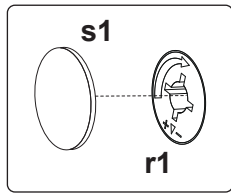
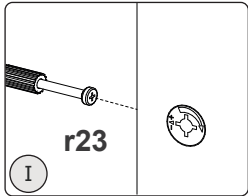

## D

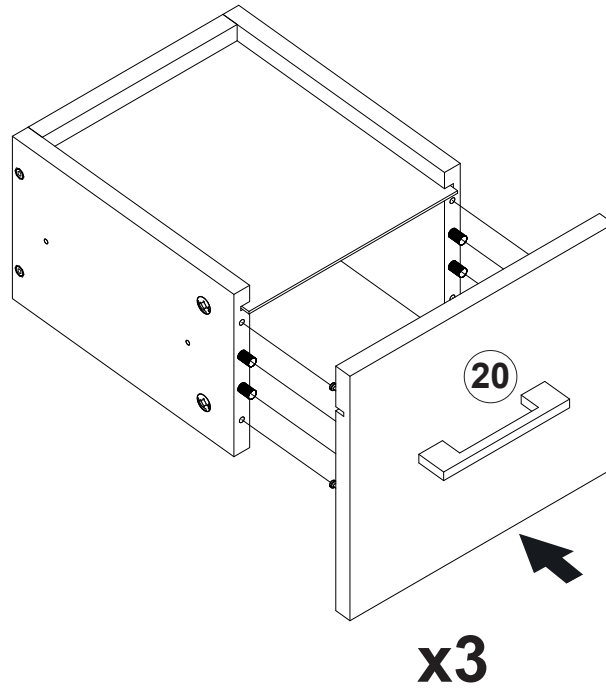

## E

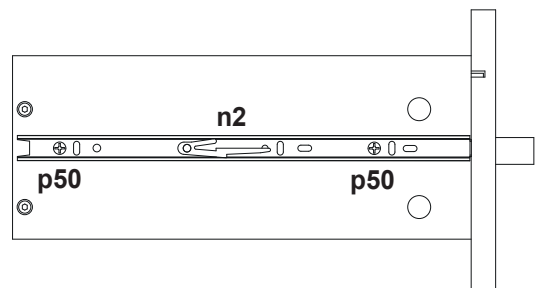
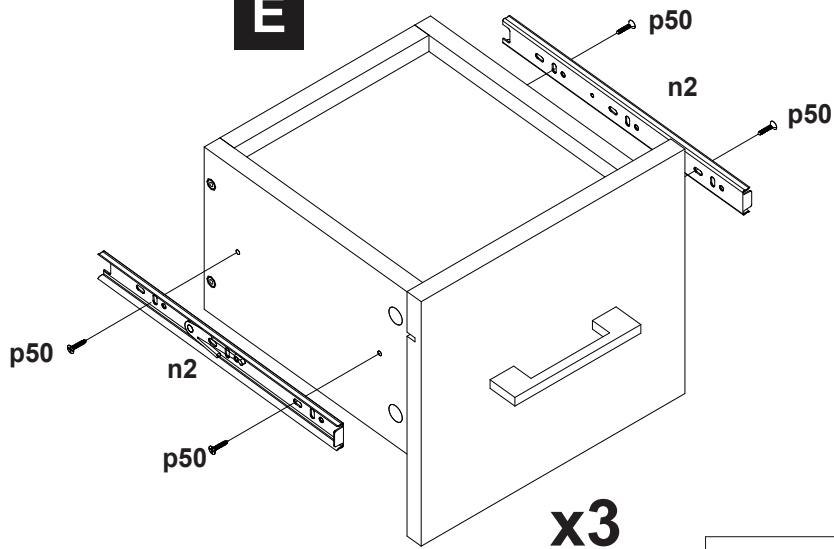

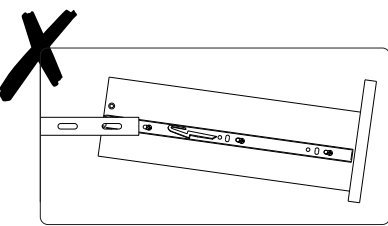
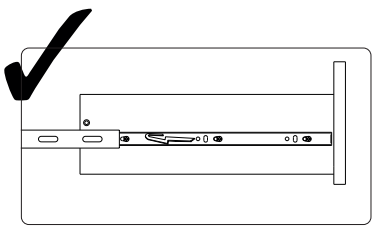
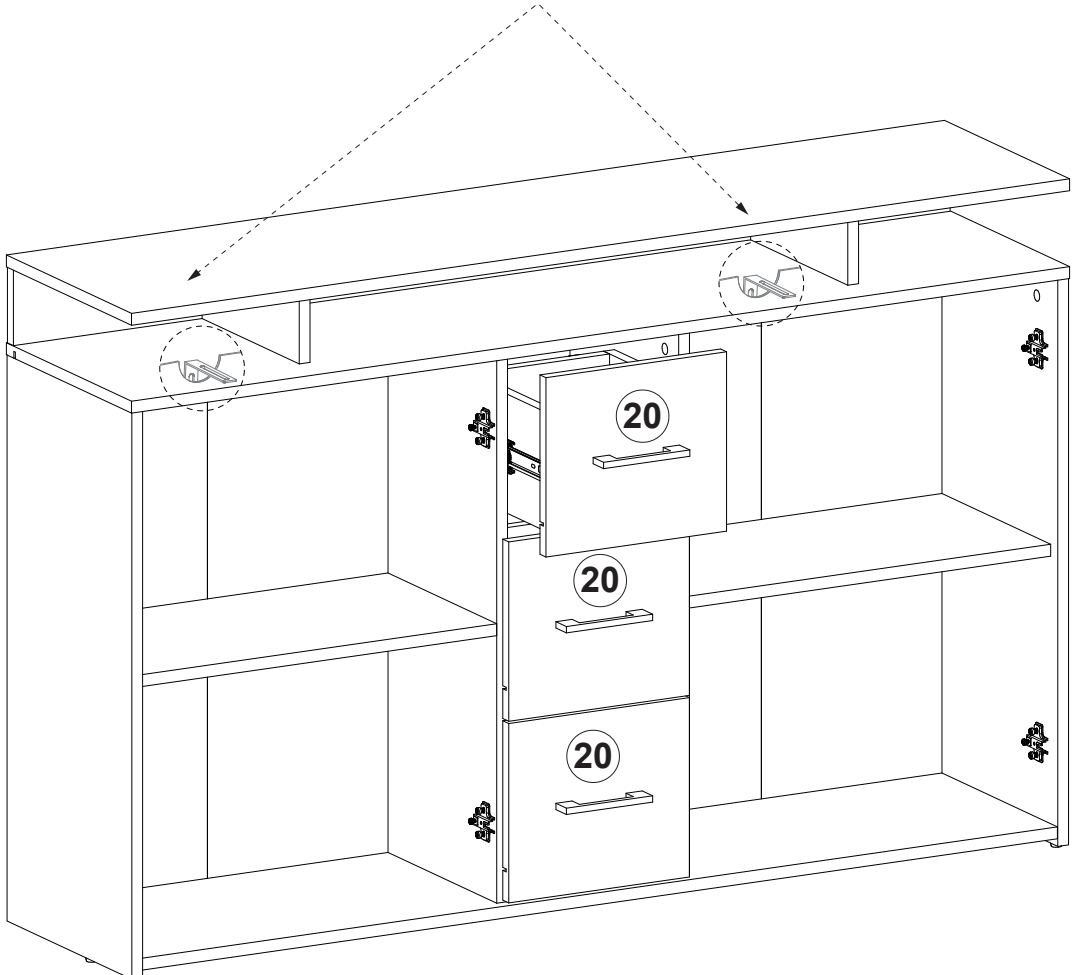
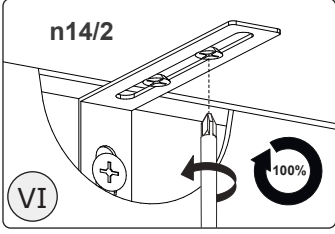
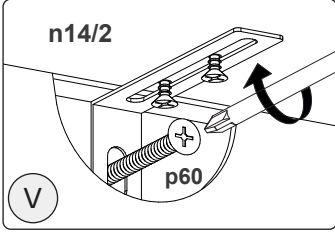
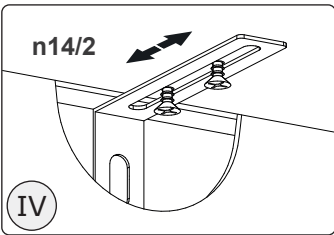
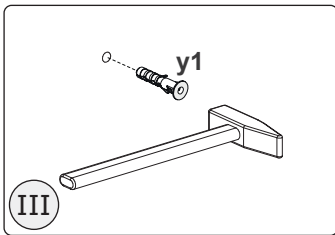
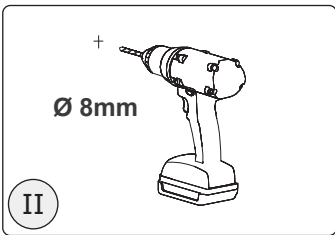
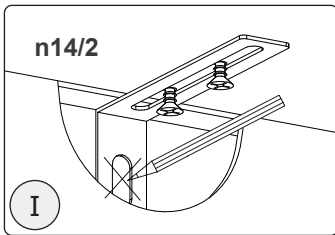
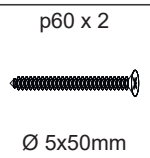
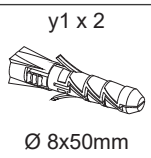

# 14

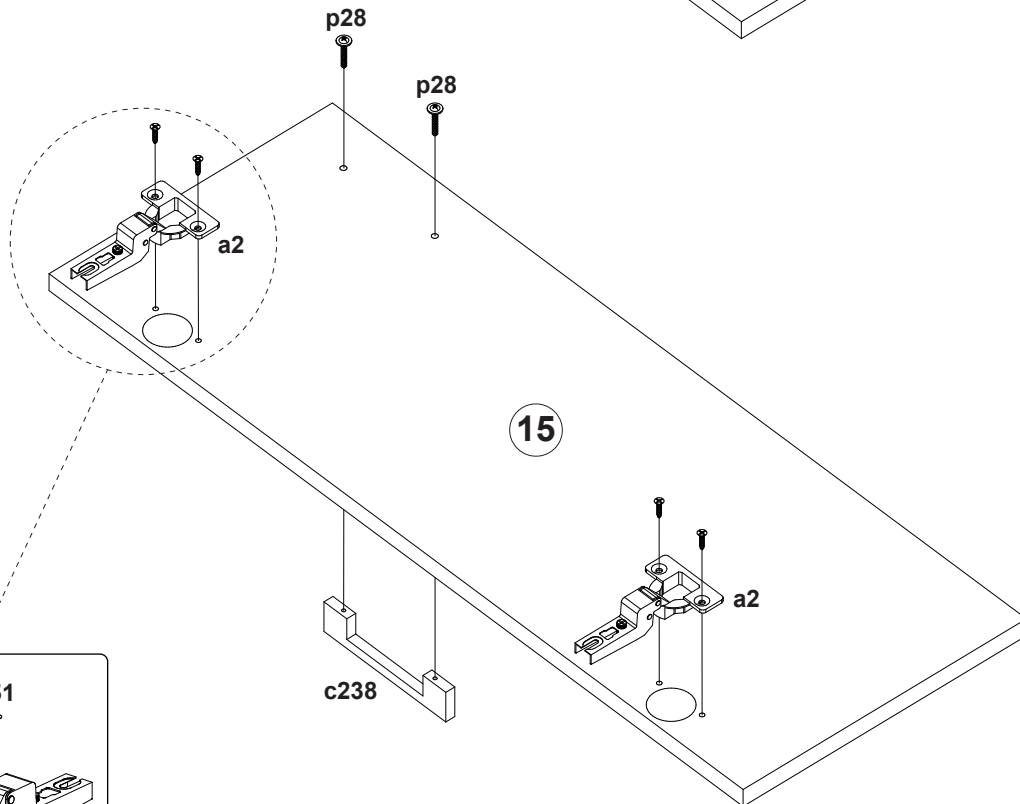
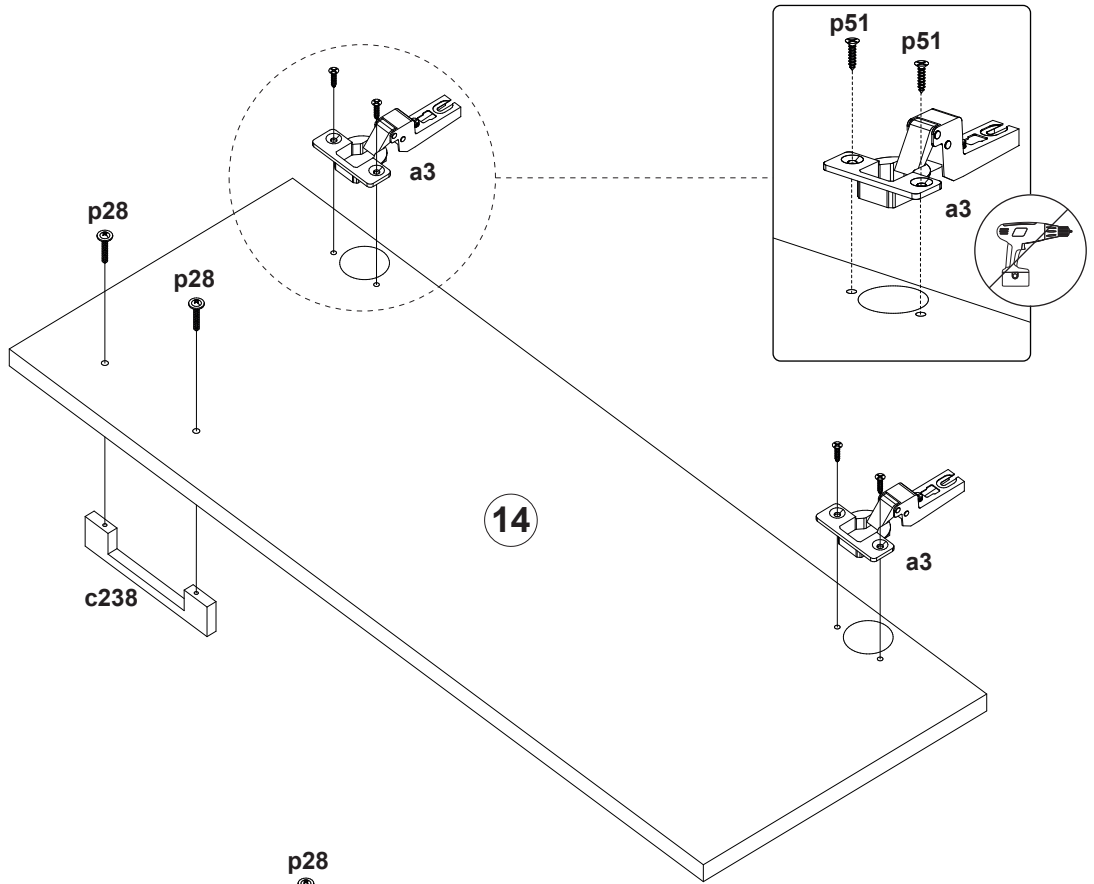
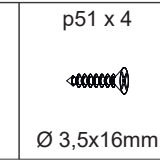
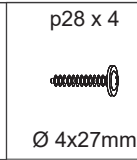
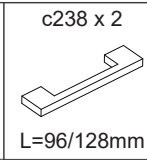
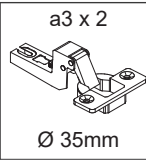
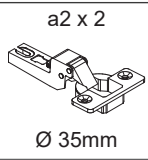

# 15

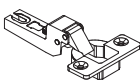
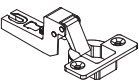
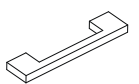

# 16

a2 x 2  Ø 35mm	a3 x 2  Ø 35mm	c238 x 2  L=96/128mm	p28 x 4  Ø 4x27mm	p51 x 4  Ø 3,5x16mm
---	---	---	--	--

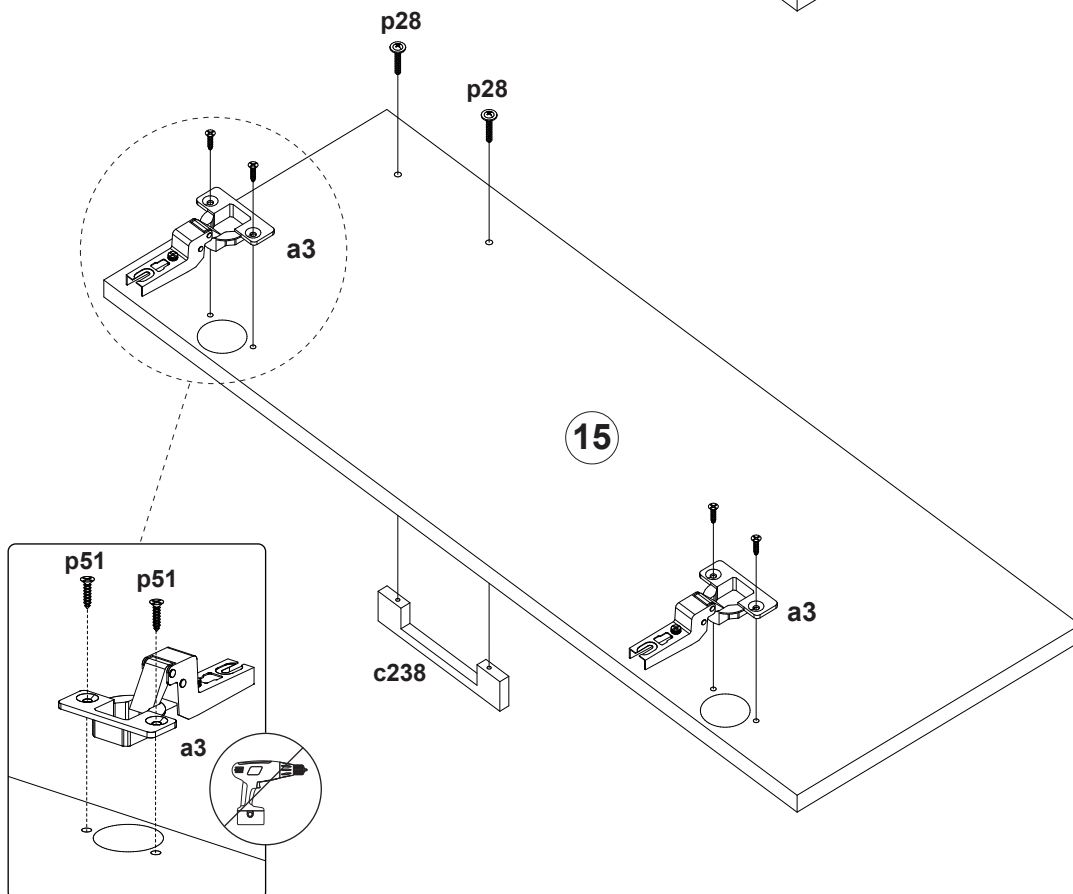
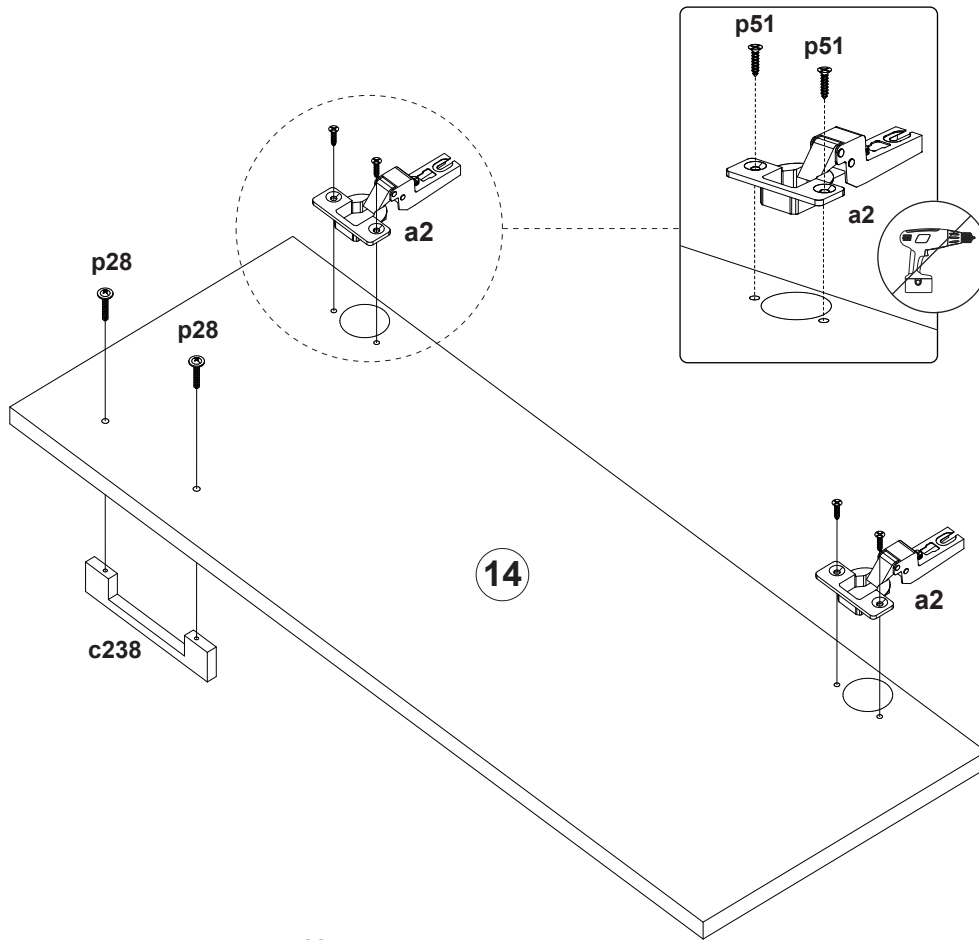

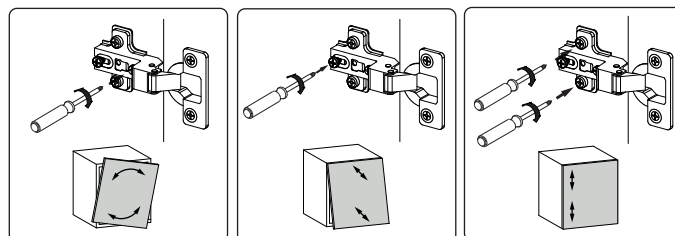
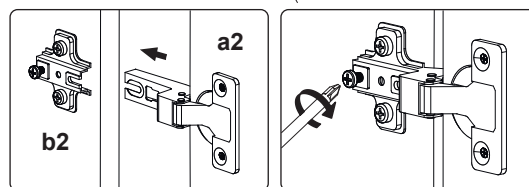
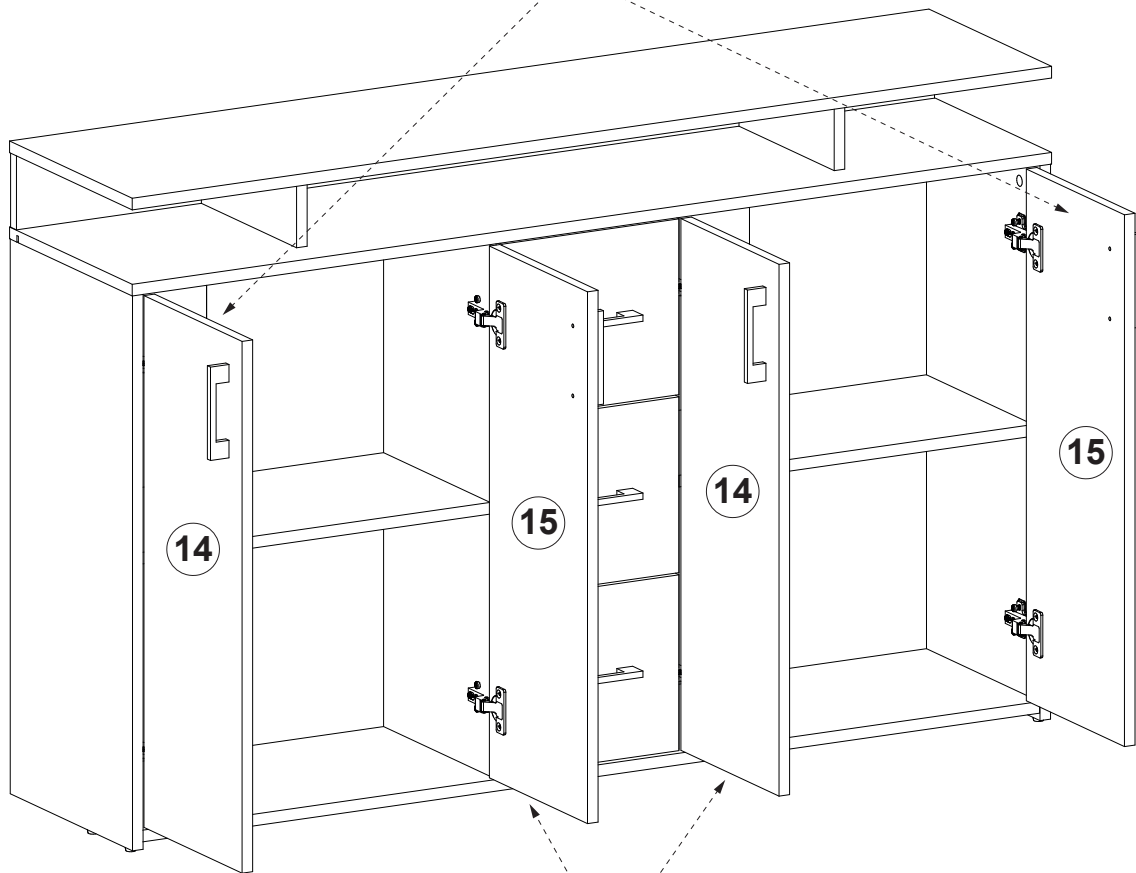
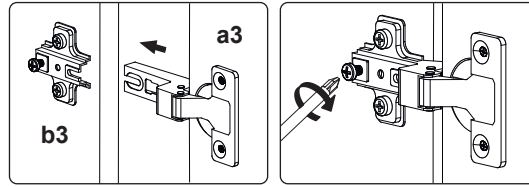
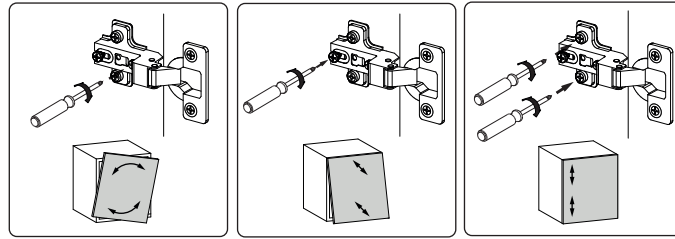



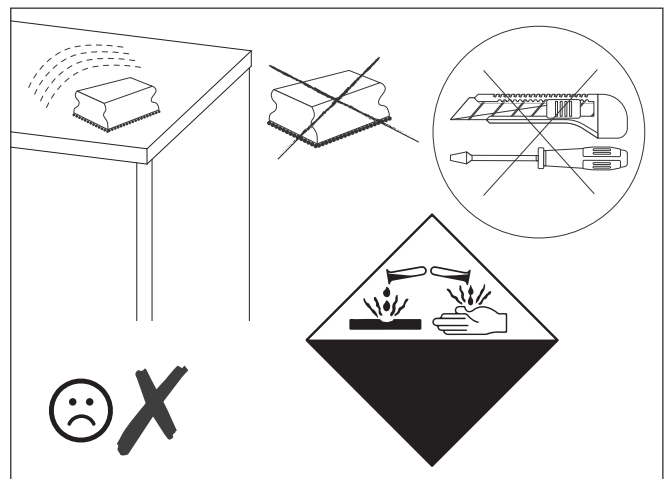
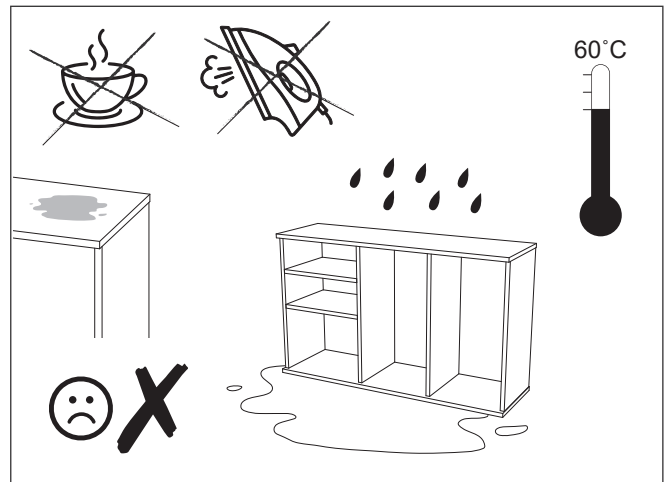
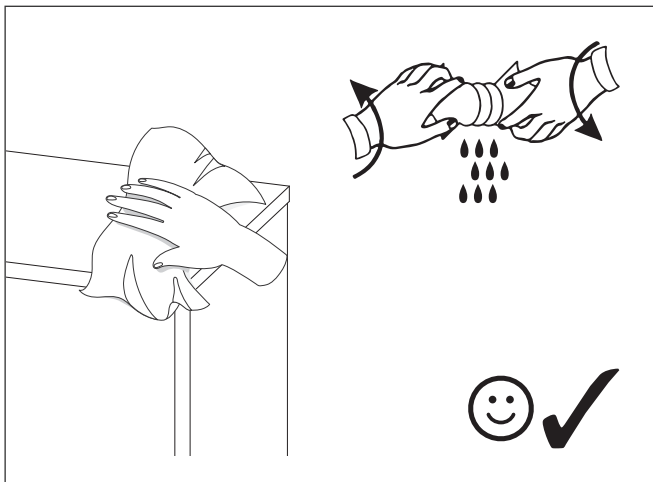
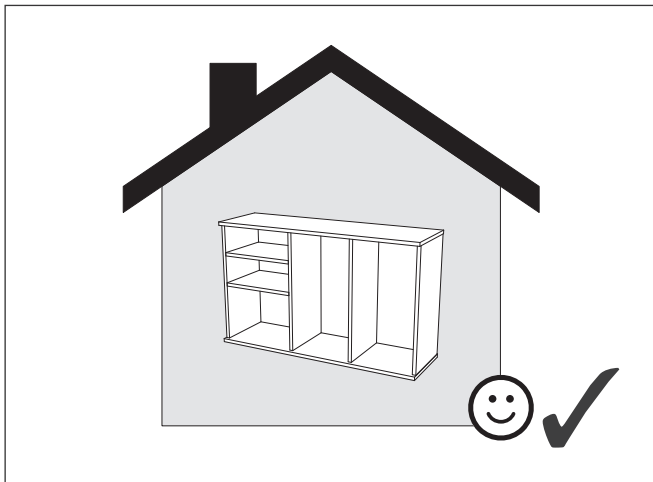

- PL** Powierzchnię mebli należy czyścić tylko środkami do pielęgnacji mebli. Szanowny kliencie w przypadku reklamacji prosimy wypełnić druki reklamacyjne dostępne w punktach sprzedaży przedkładając Kartę Reklamacyjną (zawierającą datę produkcji i numer pakowacza lub zmiany pakowania) umieszczoną w każdej z paczek, oraz instrukcję montażu mebla, gdzie prosimy o zaznaczenie uszkodzonego elementu.
- SK** Povrch nábytku čistite iba prostriedkami určenými na ošetrovanie nábytku. Vá ení zákazníci! V prípade reklamácie prosíme, aby ste vyplnili tlačivá, ktoré sú prístupné v obchodoch, predlo ili Reklamačný list (ktorý obsahuje dátum výroby a číslo baliča alebo číslo zmeny pri balení), ktorý sa nachádza v ka dom balení a návod na montáž nábytku, v ktorom označte poškodenú časť.
- CZ** Povrch nábytku čistěte pouze přípravky určenými k ošetřování nábytku. Vá ený zákazník, v případě uplatnění reklamacie vyplňte prosím reklamační formuláře, které jsou dostupné v prodejnách a předlo te Reklamační kartu (obsahující datum výroby a číslo balení nebo změny balení, která je umístěna v balíčku) a návod k obsluze s vyznačením poškozeného dílu.
- BG** Повърхността на мебелите трябва да се почиства само с препарати за поддържане на мебели. Уважаеми клиенти, в случай на рекламация моля попълнете формулярите за рекламация, които ще получите в търговските пунктове, като представите Картата за рекламация (съдържаща датата на производство и номера на опаковчика или смяната за опаковане), която ще намерите във всяка опаковка, и инструкцията за монтаж на мебела, върху която да отбележите повредения елемент.
- RO** Suprafața ei trebuie să fie curățată numai cu substanțe destinate pentru curățarea mobilei. Stimată Cumpărător, în caz de reclamație vă rugăm să completați formularul de reclamație pe care îl puteți lua de la punctul de vânzare și pe care îl veți prezenta împreună cu Cartela de Garanție (care conține data producției și nr ambalatorului sau țurei de ambalare), însoțită la fiecare ambalaj, precum și instrucțiunile de montaj ale mobilei, pe care vă rugăm să marcați elementul deteriorat.
- UA** Поверхню меблів потрібно чистити тільки засобами для догляду за меблями. Шановний клієнте для заяви рекламачії, просимо заповнити формуляр рекламачії, доступний у пунктах продажу, вказуючи рекламачійну карту (містить дату виробництва та номер пакувальника або зміни упаковки), прикладену до кожного пакету, а також інструкцію з монтажу меблів, на якій просимо позначити пошкоджений елемент.
- RUS** Поверхность мебели надо чистить только средствами для ухода за мебелью. Уважаемый клиент для заявления рекламации, просим заполнить формуляр рекламации, доступный в пунктах продажи, указывая Рекламационную карту (содержащую дату производства и номер упаковщика или смены упаковки), приложенную к каждому пакету, а также инструкцию по монтажу мебели, на которой просим обозначить поврежденный элемент.
- DE** Reinigen Sie den Möbelbereich nur mit Möbelpflege. Kunden, bei Beanstandung Bitte füllen Sie die Reklamationsformulare, die in den Verkaufsabteilungen erhältlich sind, vor dem Verkauf aus eine Reklamationskarte (mit Angabe des Produktionsdatums und der Anzahl der Personen, die die Waren verpacken, oder der Anzahl der Schichten) Verpackung), die in jeder Packung enthalten ist, und Halterungen, in denen Sie reichlich vorhanden oder beschädigt sind Elemente Reinigen Sie den Möbelbereich nur mit Möbelpflege. Kunden, bei Beanstandung.
- GB** Furniture surface must be cleaned only with furniture maintenance formulas. Dear Customer, should you wish to file a complaint, we would request you to fill in the complaint forms available in our outlets, submitting the Complaint Card (specifying the date manufactured, packaging employee/ shift code) enclosed in each of the packets, together with the Assembly Manual, where please highlight the faulty component.
- H** A bútorok felületét kizárólag a bútorápolószerekkel lehet tisztítani. Tisztelt Vásárló! Reklamáció esetén kérjük az eladási helyeken kapható reklamációs nyomtatványokat kitölteni a Reklamációs Lap (tartalmazza a gyártási dátumát és csomagoló számát vagy műszakszámát) bemutatásával, amely mindegyik csomagban található, valamint a bútor szerelési utasítását, amelyen kérjük a sérült elemet bejelölni szíveskedjék.
- FR** La surface des meubles ne peut être nettoyée qu'avec des produits pour l'entretien de meubles. Cher Client, en cas de réclamation, veuillez bien remplir des formulaires de réclamation accessibles dans les centres de vente en montrant le mode d'emploi pour monter le meuble. Nous vous demandons de bien vouloir y entourer l'élément en panne.
- ES** Limpiar la superficie de muebles exclusivamente con los agentes para el cuidado de los muebles. Estimado Cliente, en caso de reclamaciones, hagan favor de rellenar los formularios de reclamación disponibles en los puntos de venta, presentando las instrucciones de montaje de mueble, donde es necesario indicar un elemento estropeado.
- NL** Het oppervlak van meubels hoeft alleen te worden gereinigd door middel van meubelverzorging Beste klant voor de verklaring!  
klacht, vul dan het klachtenformulier in dat beschikbaar is in de verkooppunten, met vermelding van: klachtenkaart (bevat de fabricagedatum en het nummer van de verpakker of verandering van verpakking), bevestigd aan elk pakket, evenals instructies voor het installeren van meubels, die we u vragen te markeren beschadigd item.
- IT** **Pulire le superfici dei mobili solo con gli appositi detergenti. Gentile Cliente, se desidera presentare un reclamo, Le chiediamo di compilare i moduli di reclamo disponibili presso i nostri punti vendita, presentando la Scheda di reclamo (specificando la data di produzione, l'imballaggio della merce o il numero di strati di imballaggio) allegata a ciascuna confezione, insieme al manuale di montaggio, dove si prega di evidenziare l'articolo difettoso.**