

Assembly Instructions



1/1

D80-ZL

External tools needed for assembly: hammer, screwdriver

Perla

Optional tools : Power drill with screwdriver bit

260cm

Please follow steps

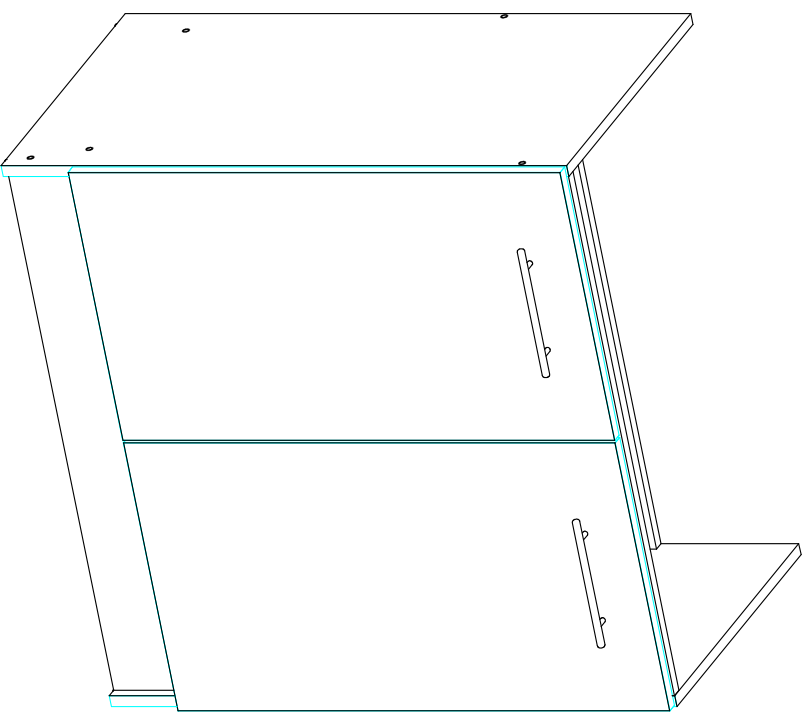
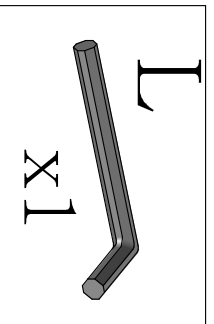
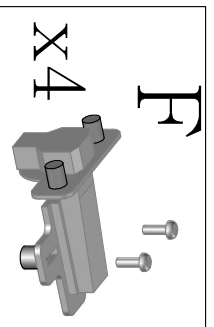
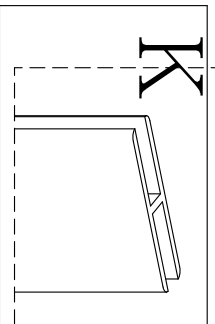
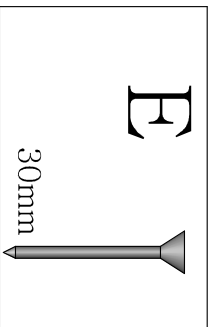
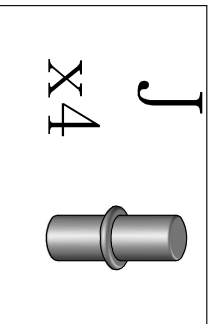
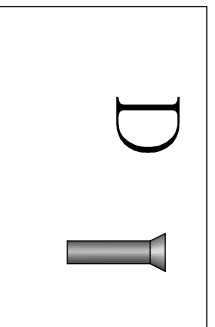
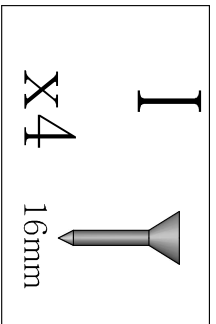
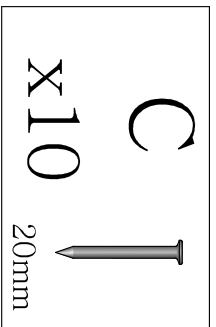
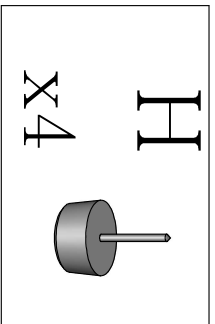
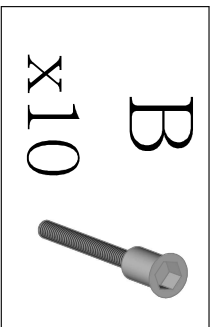
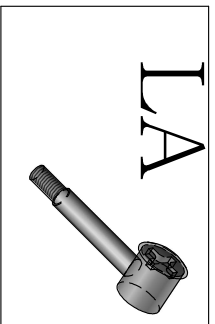
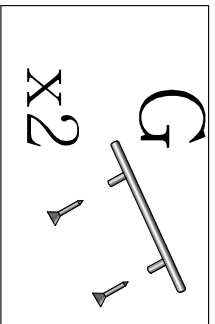
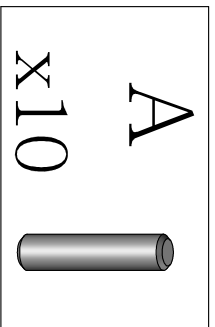

Assembly Instructions



2

D80-ZL\_

External tools needed for assembly: hammer, screwdriver

Perła

Optional tools :Power drill with screwdriver bit

260cm

Please follow steps

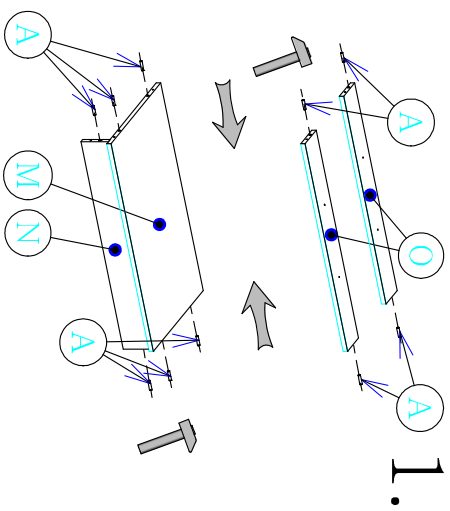

1.

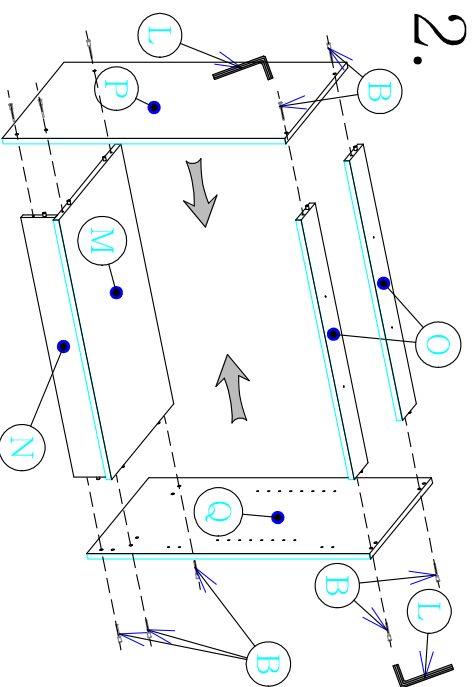

2.

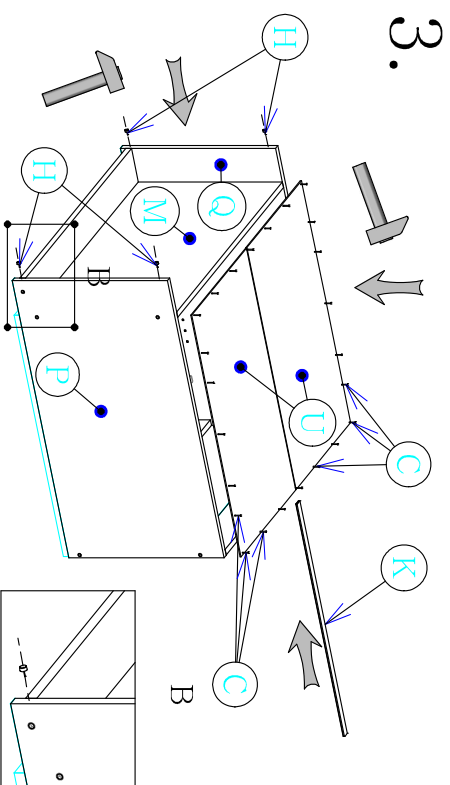

3.

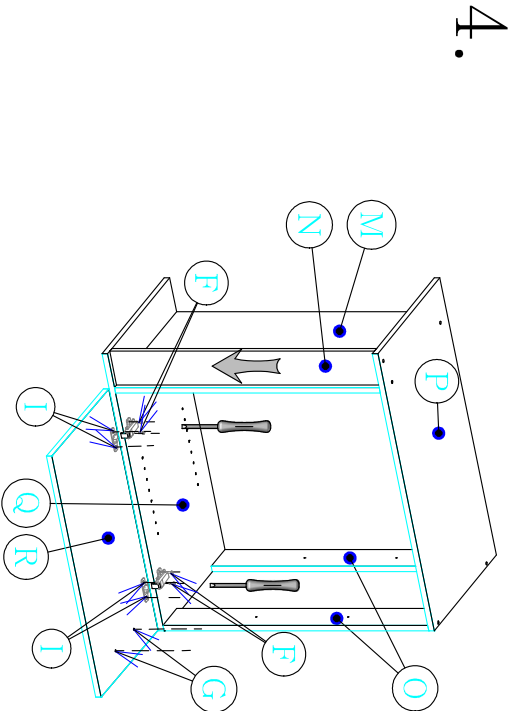

4.

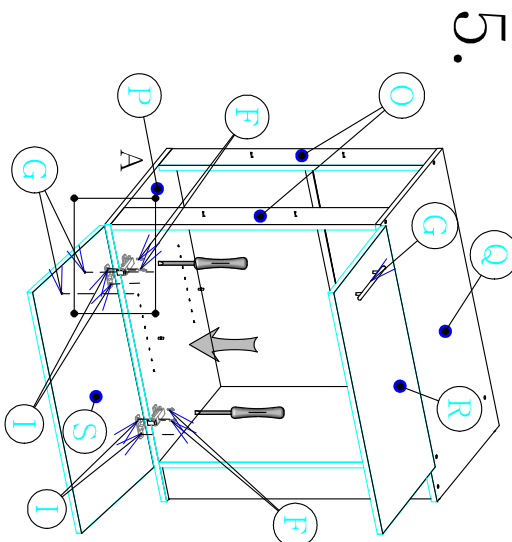

5.

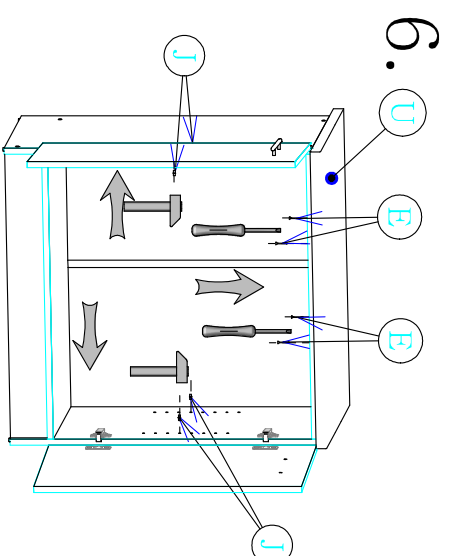

6.

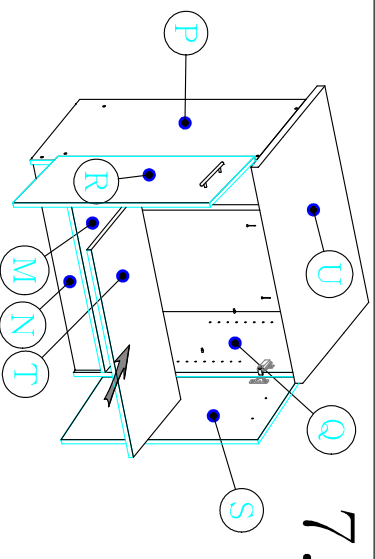

7.

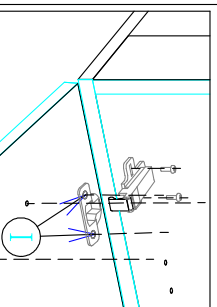

A

Assembly Instructions

**HALMAR**

1/1

D80

Perta

260cm

External tools needed for assembly: hammer, screwdriver

Optional tools : Power drill with screwdriver bit

Please follow steps

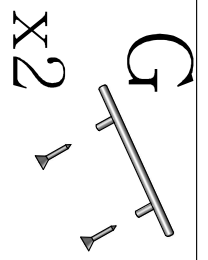
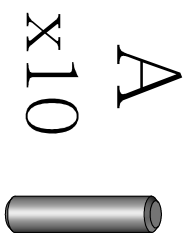

LA

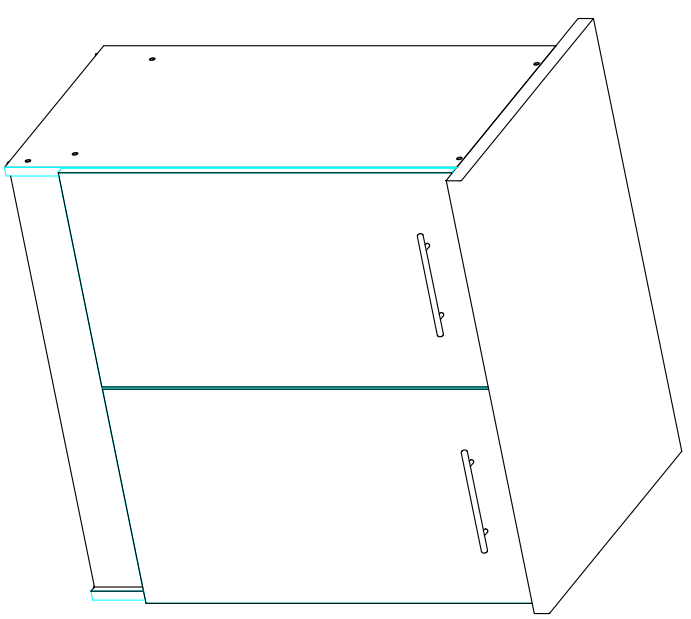
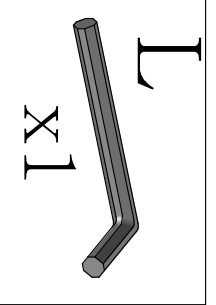
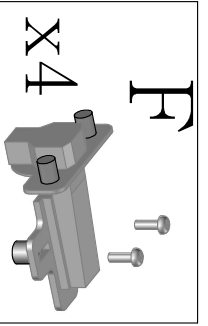
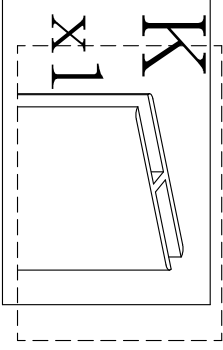
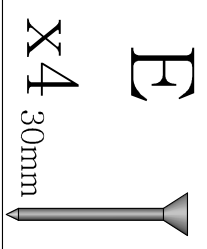
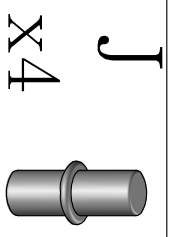
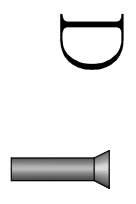
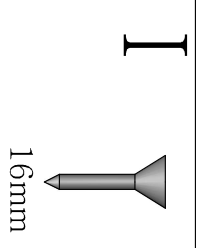
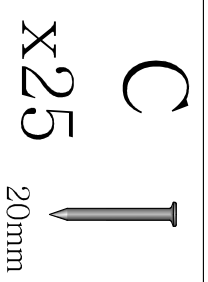
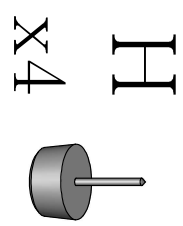
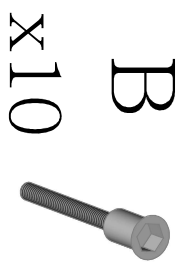
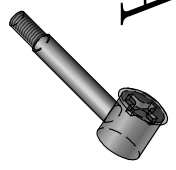

Assembly Instructions



2

D80\_

Perla

260cm

External tools needed for assembly: hammer, screwdriver

Optional tools :Power drill with screwdriver bit

Please follow steps

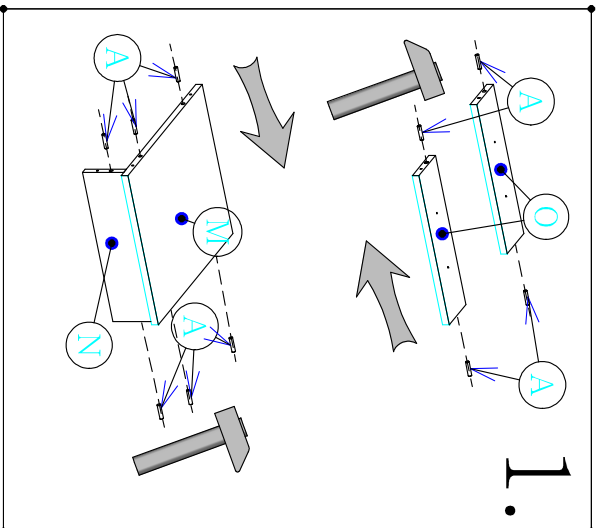

1.

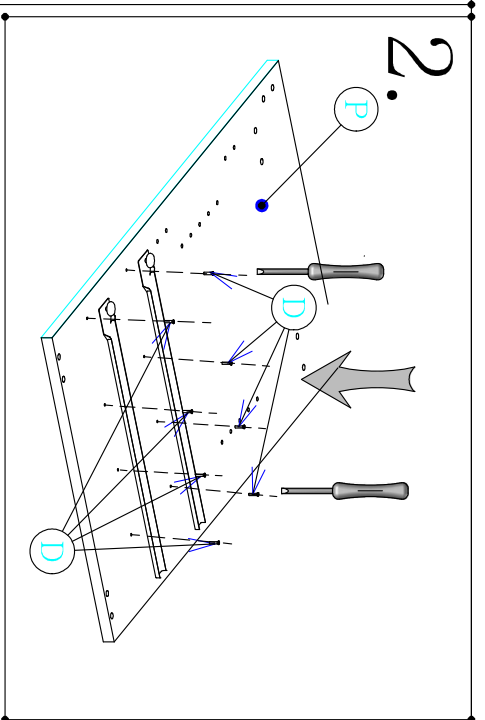

2.

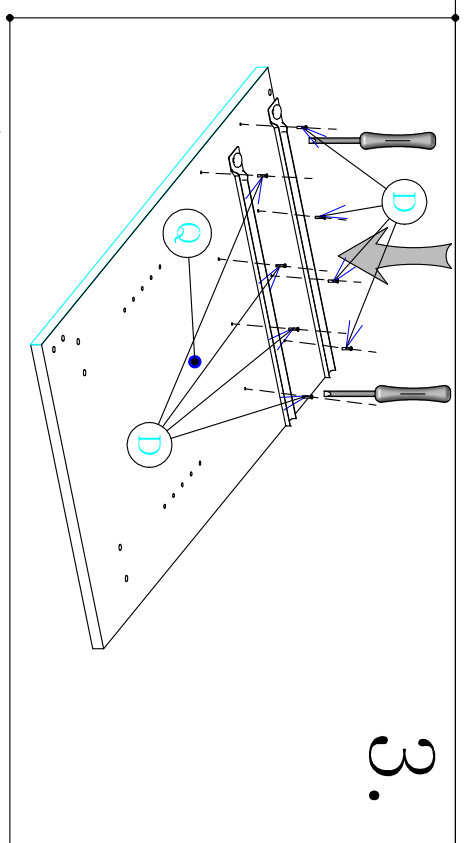

3.

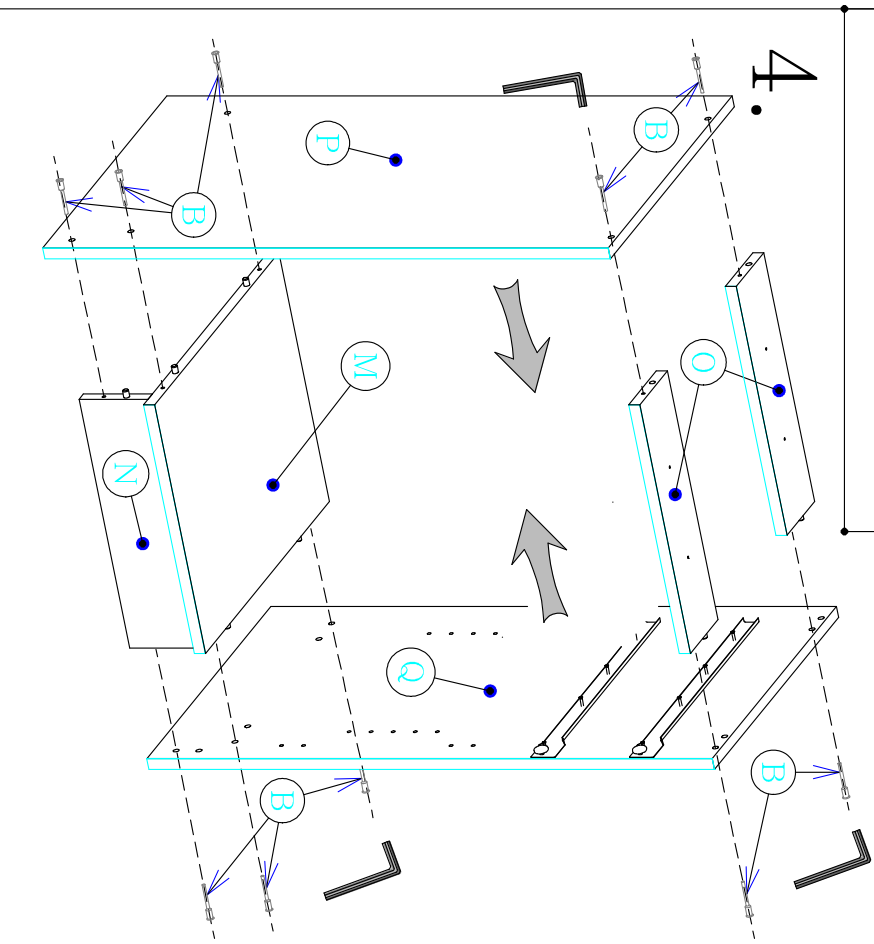

4.

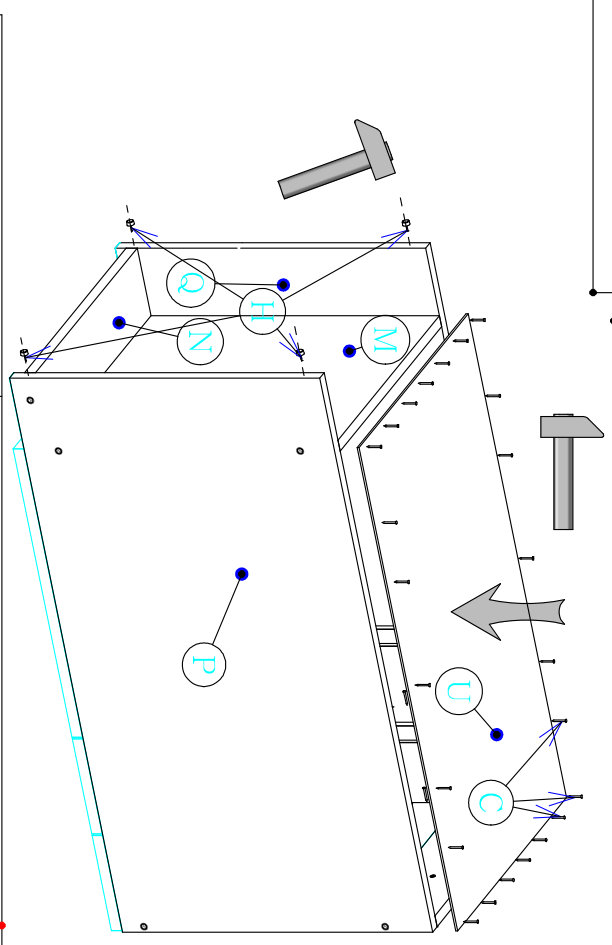

5.

Assembly Instructions



1/2

D40-SZ

External tools needed for assembly: hammer, screwdriver

Perla

Optional tools : Power drill with screwdriver bit

260cm

Please follow steps

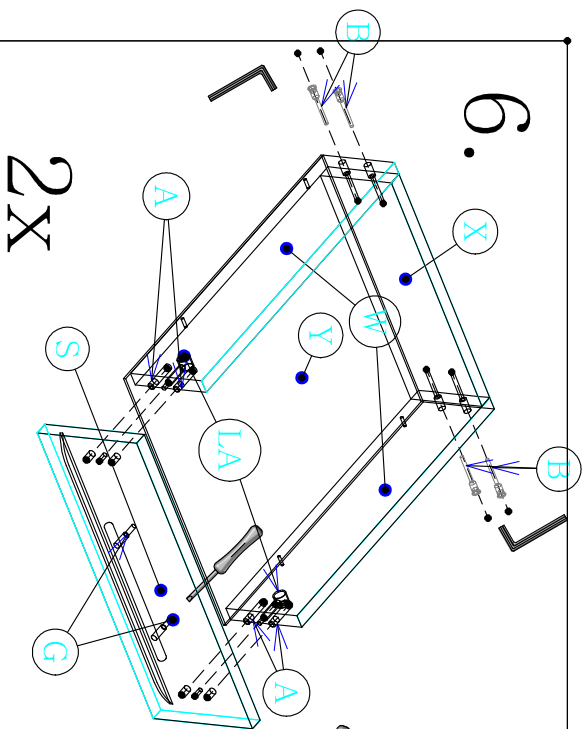

9.

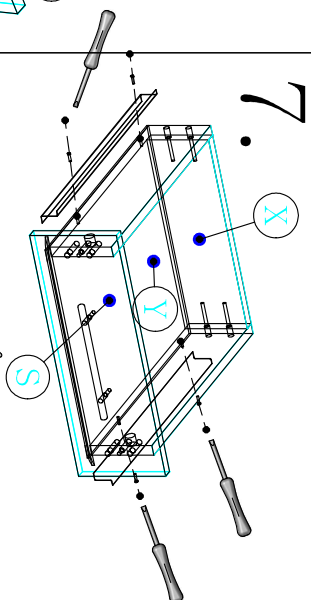
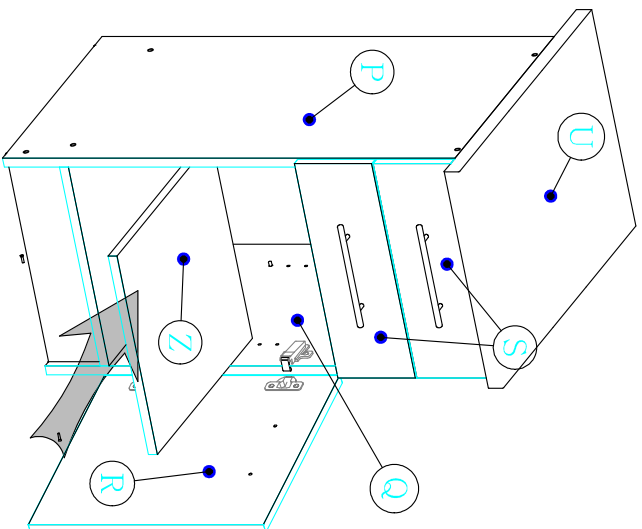

7.

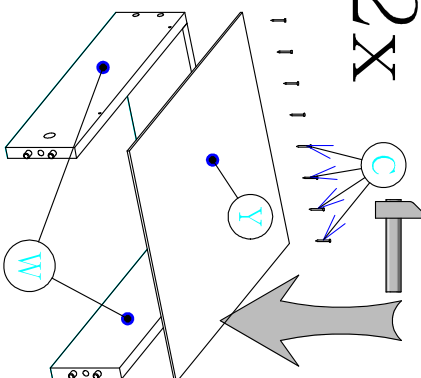

8.

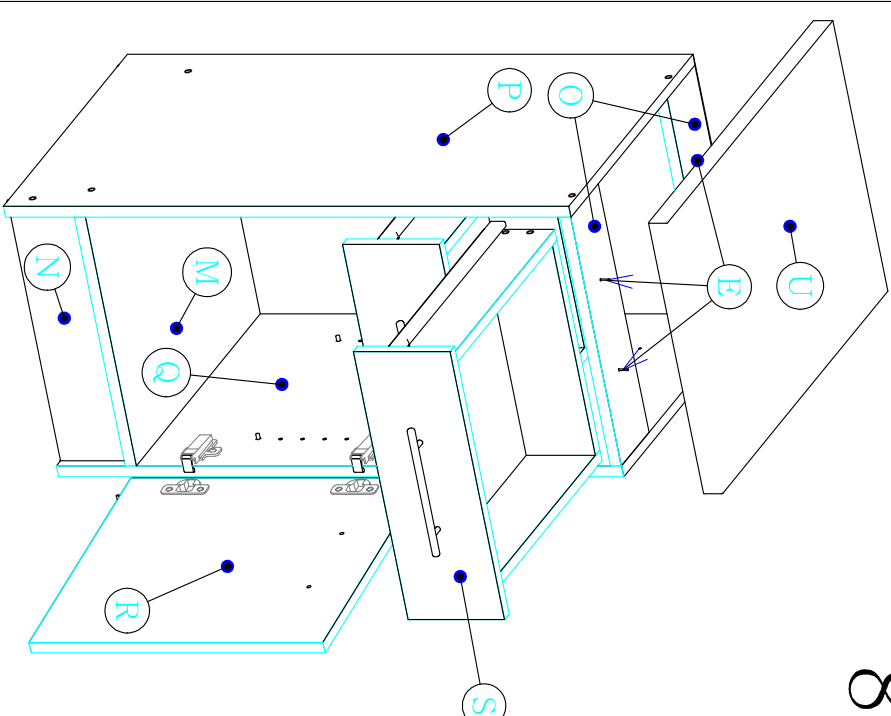

Assembly Instructions

**HALMAR**

2/2

D40-SZ

External tools needed for assembly: hammer, screwdriver

Perta

Optional tools :Power drill with screwdriver bit

260cm

Please follow steps

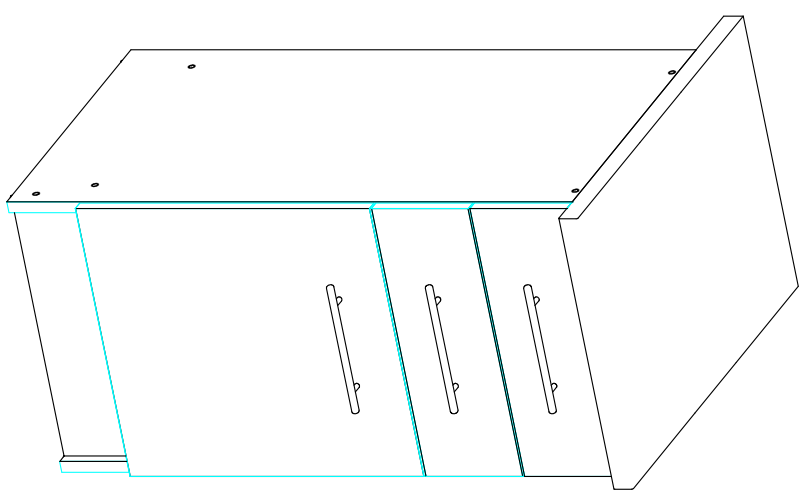
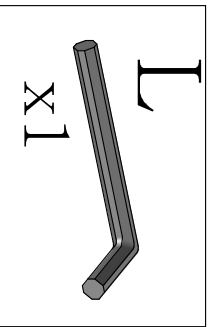
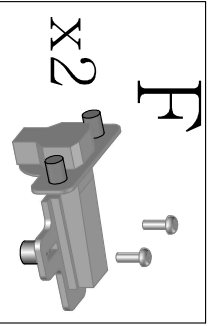
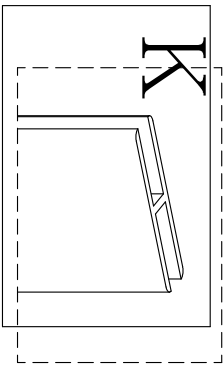
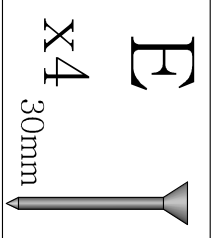
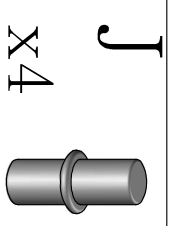
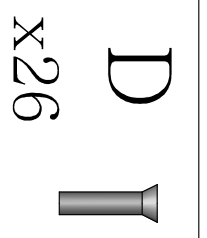
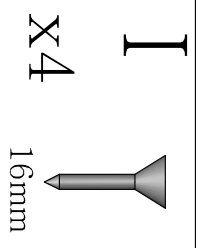
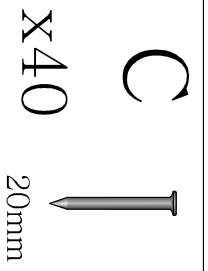
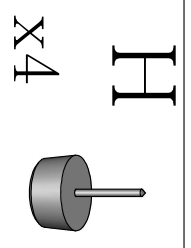
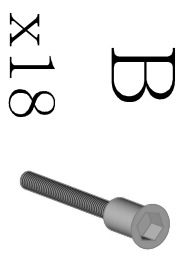
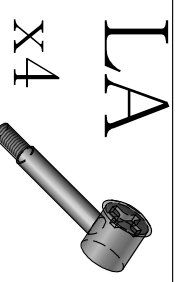
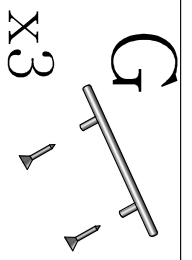
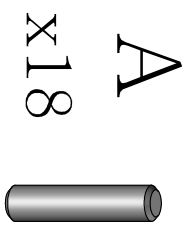

Assembly Instructions



3

D40-SZ\_

External tools needed for assembly: hammer, screwdriver

Perla

Optional tools :Power drill with screwdriver bit

260cm

Please follow steps

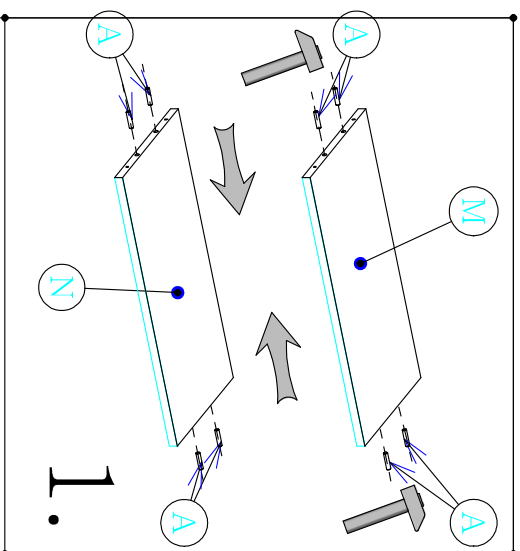

1.

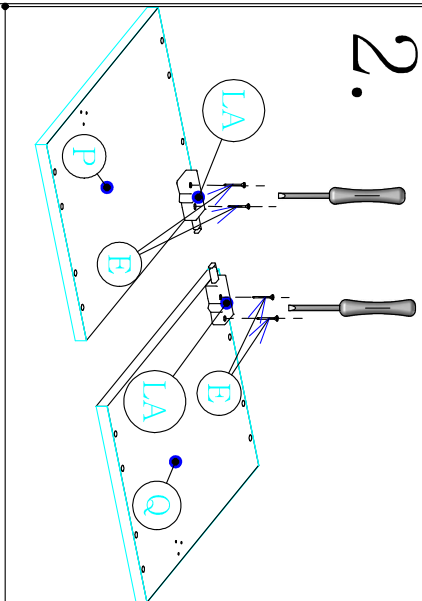

2.

5.

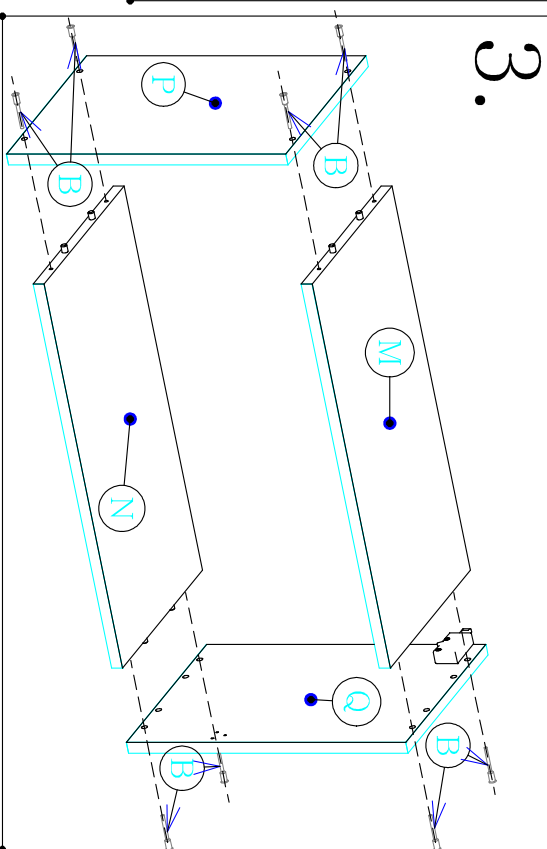

3.

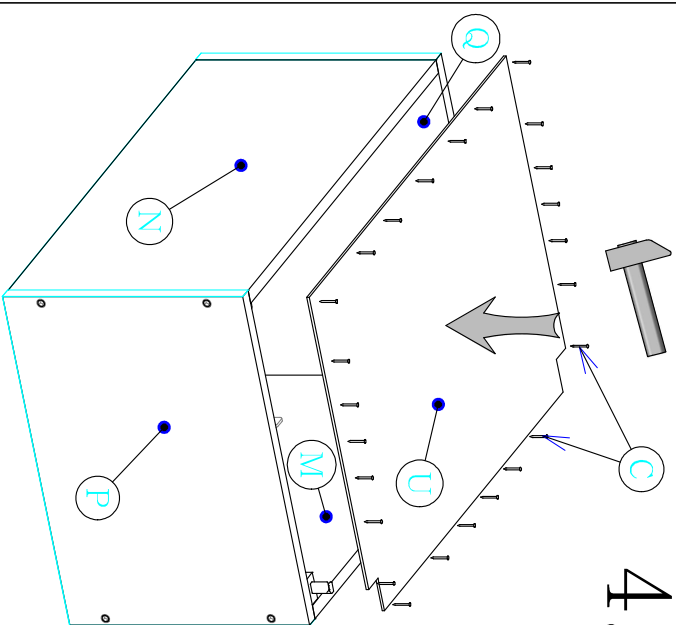

4.

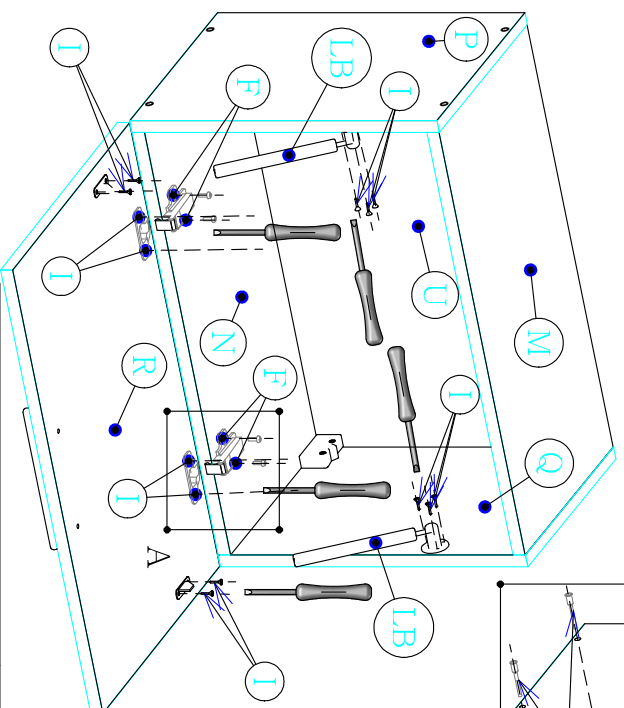

Assembly Instructions

G60-OK

Perta

260cm

**HALMAR**

1/2

External tools needed for assembly: hammer, screwdriver

Optional tools : Power drill with screwdriver bit

Please follow steps

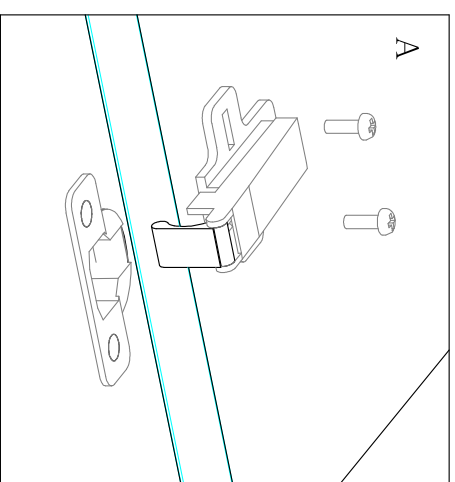

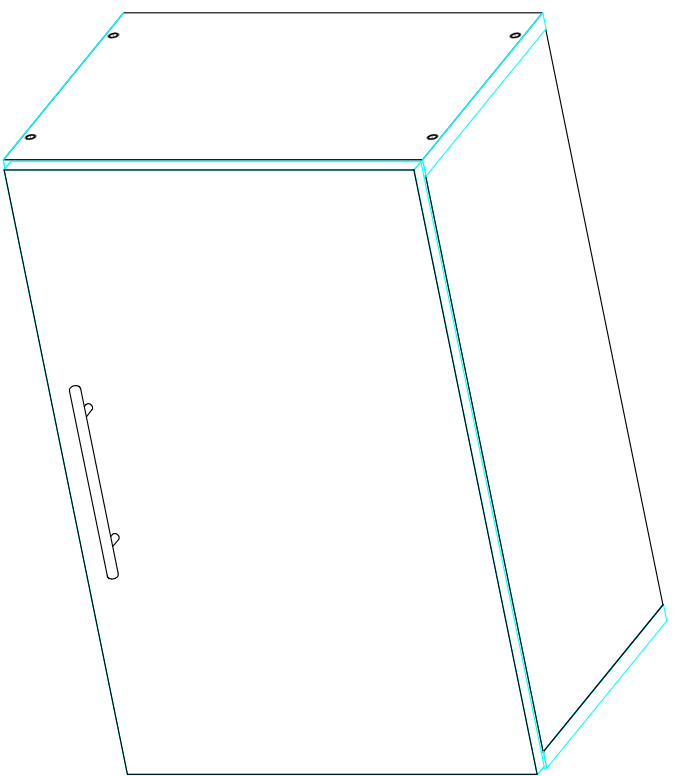
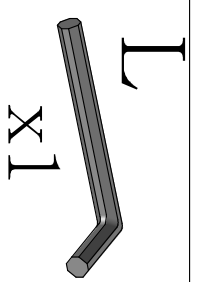
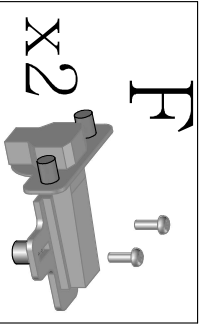
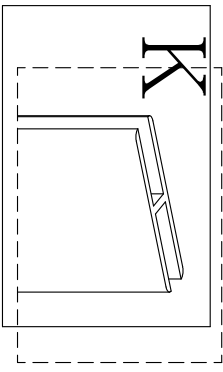
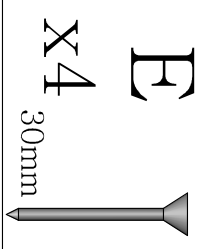
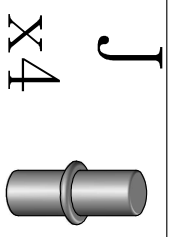
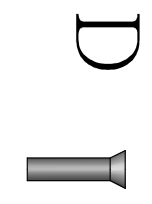
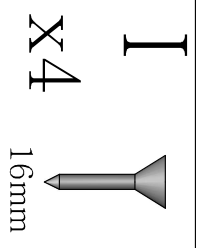
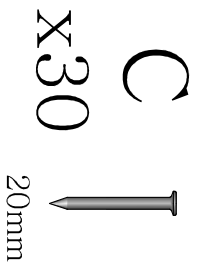
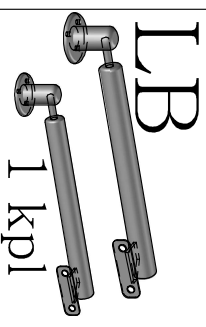
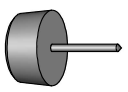
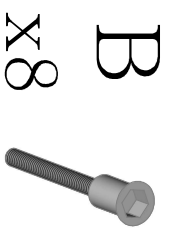
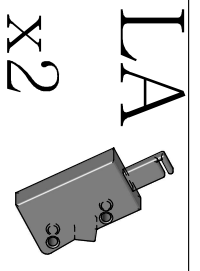
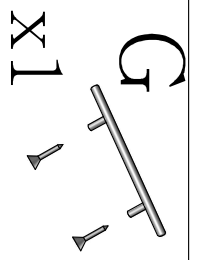
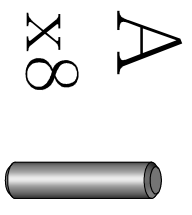

Assembly Instructions



2

G60-OK\_

External tools needed for assembly: hammer, screwdriver

Perła

Optional tools :Power drill with screwdriver bit

260cm

Please follow steps

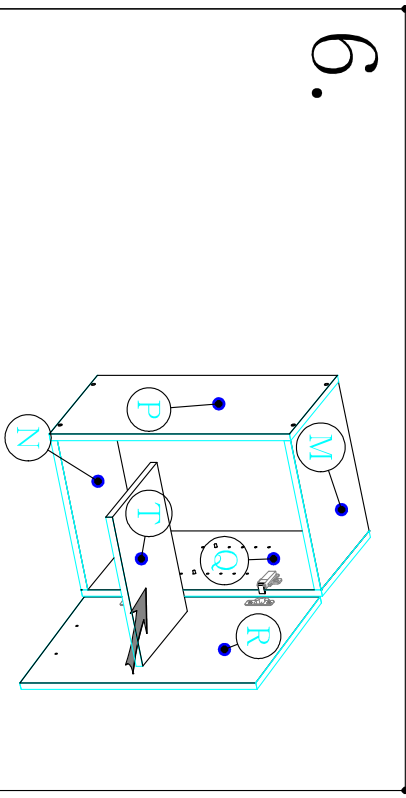
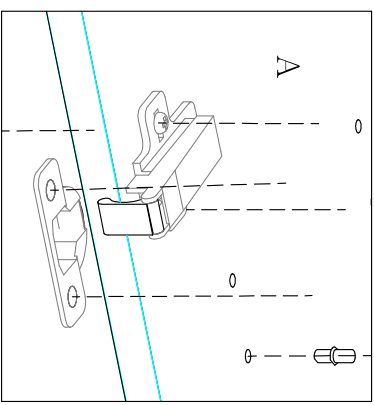
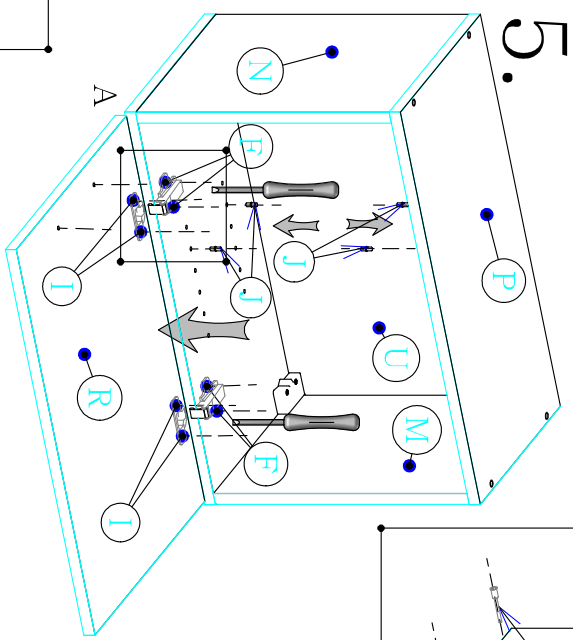
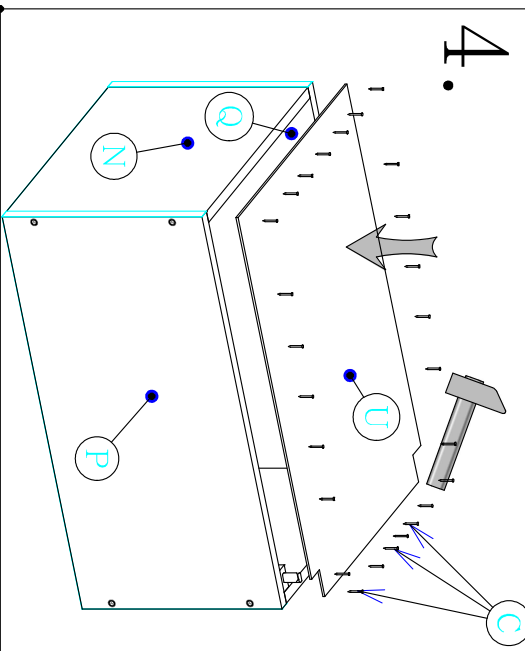
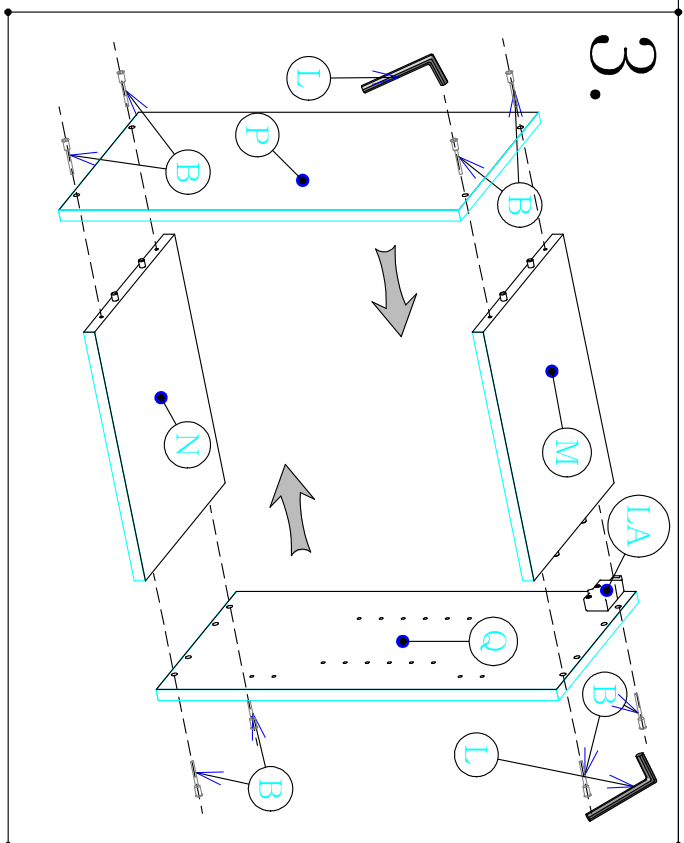
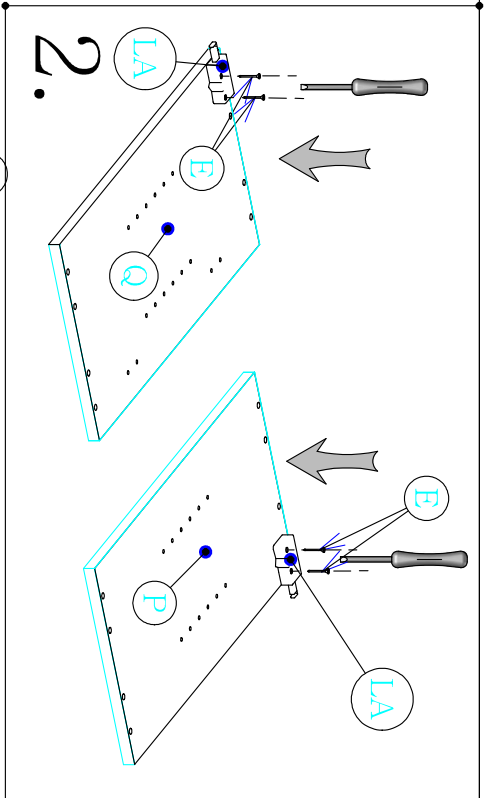
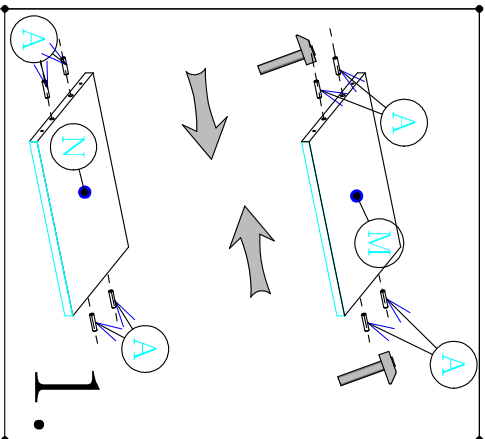

Assembly Instructions



1/1

G40-P

Perła

260cm

External tools needed for assembly: hammer, screwdriver

Optional tools :Power drill with screwdriver bit

Please follow steps

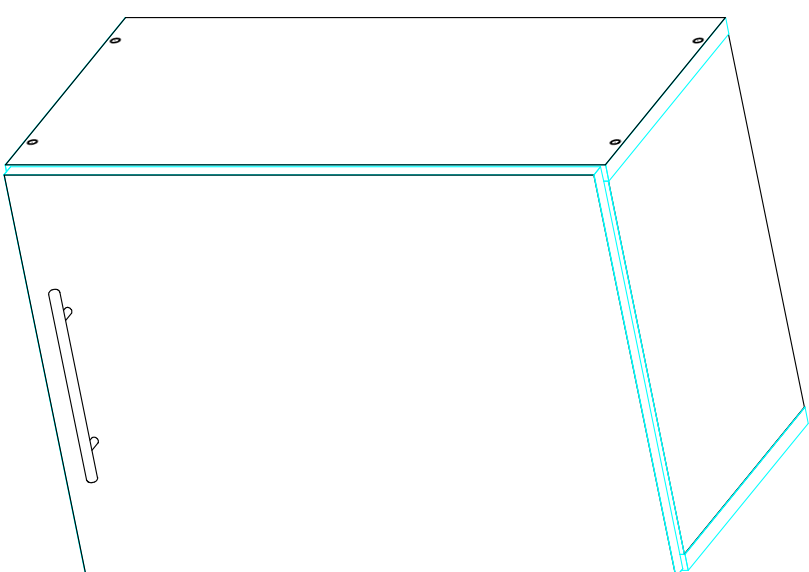
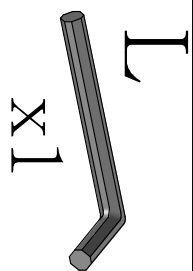
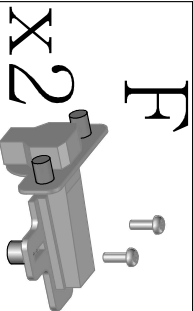
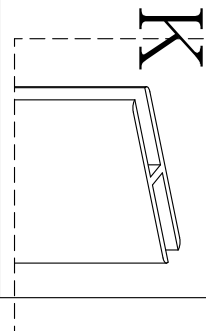
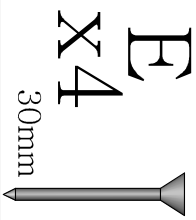
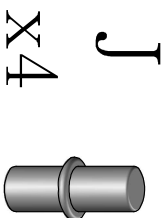
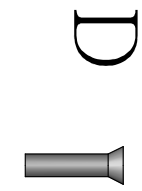
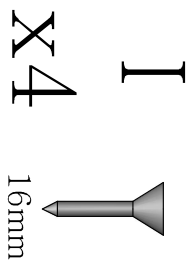
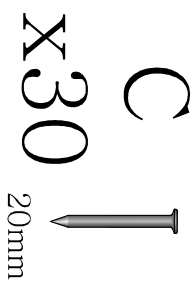
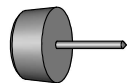
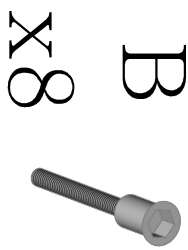
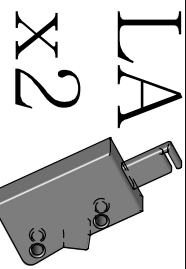
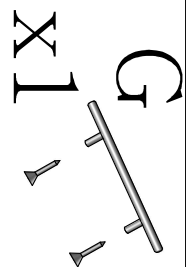
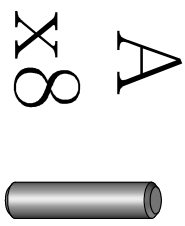

Assembly Instructions



1/1

G40-P-

External tools needed for assembly: hammer, screwdriver

Perla

Optional tools :Power drill with screwdriver bit

260cm

Please follow steps

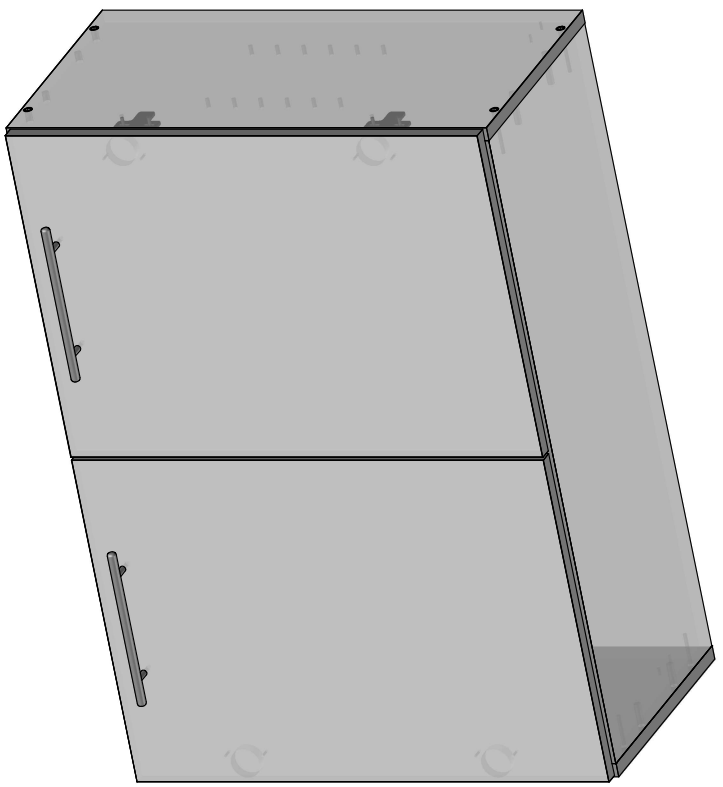
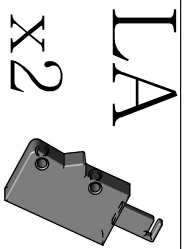
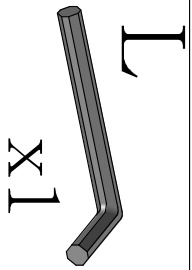
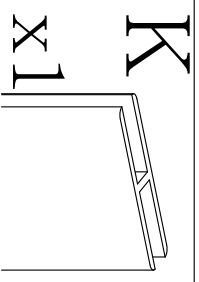
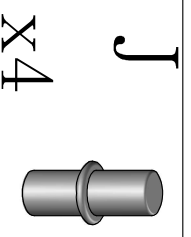
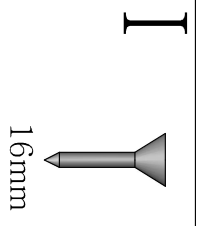
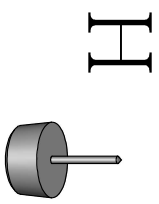
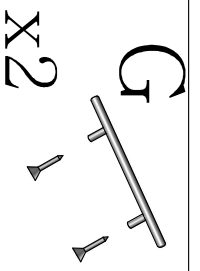
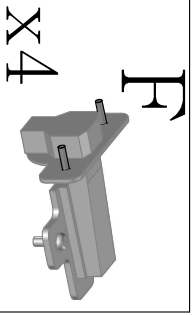
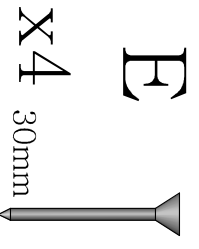
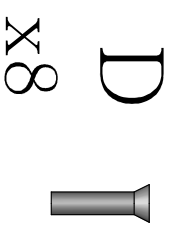
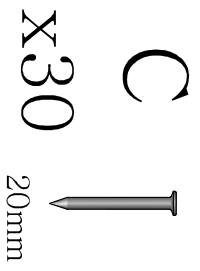
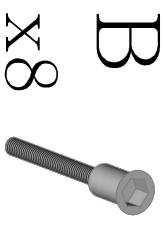
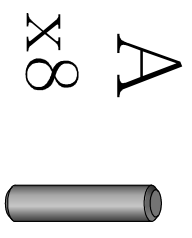

Assembly Instructions



1/1

G80\_

External tools needed for assembly: hammer, screwdriver

Perla

Optional tools :Power drill with screwdriver bit

260cm

Please follow steps

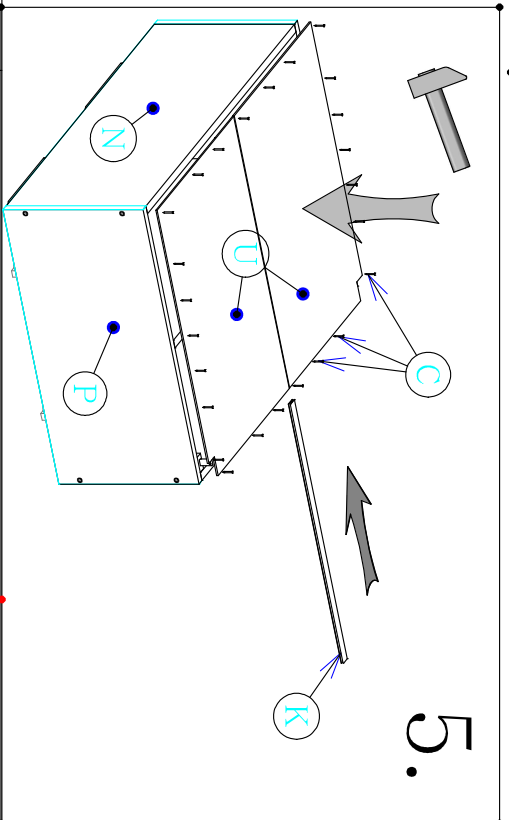
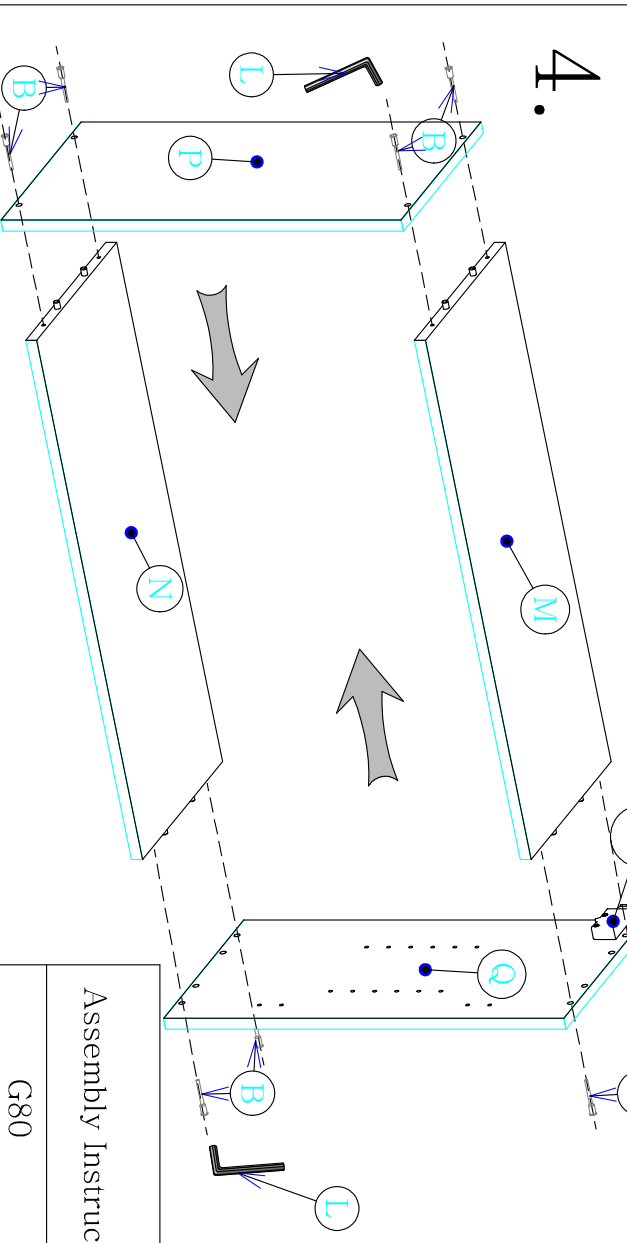
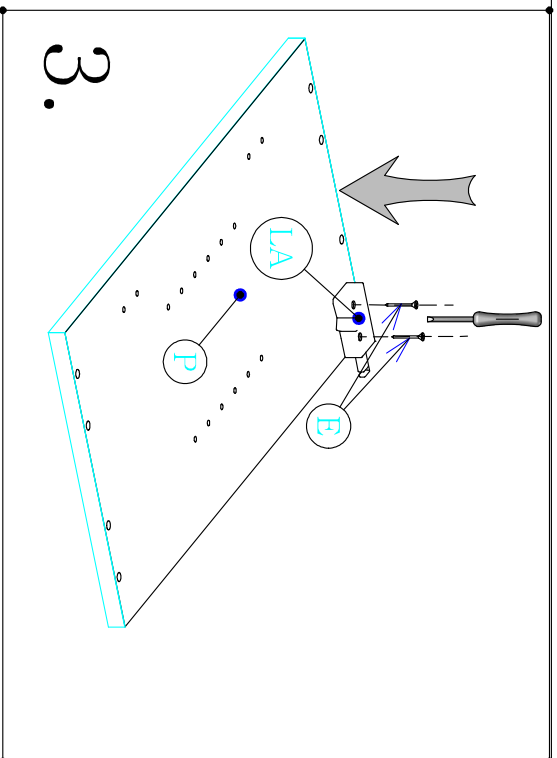
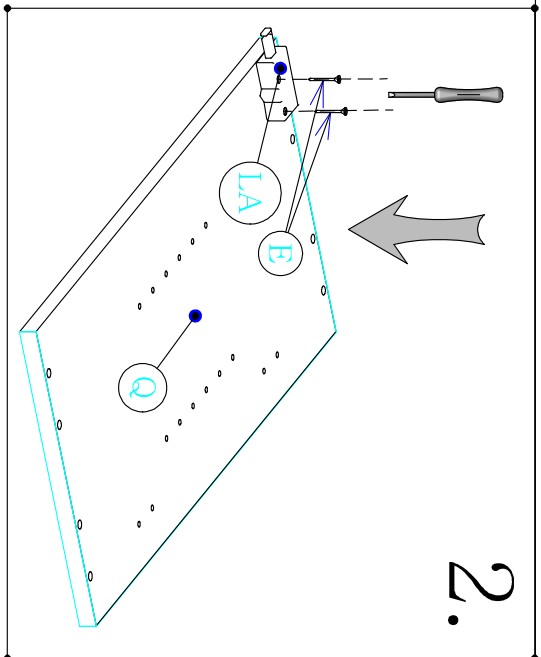
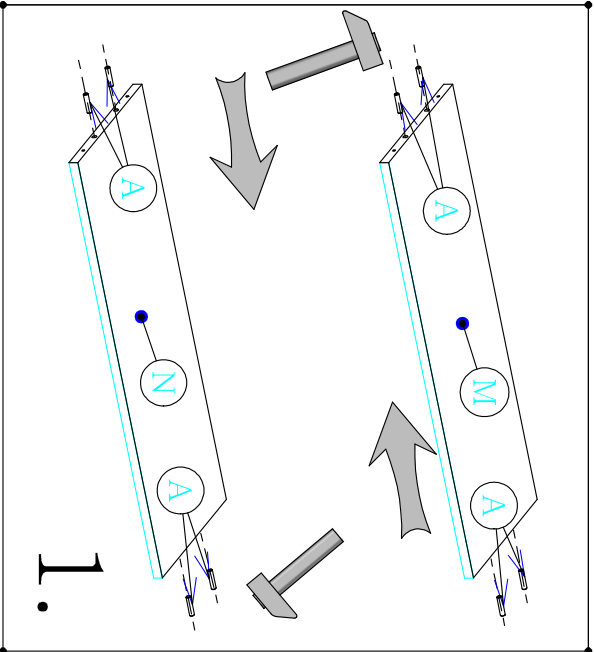

Assembly Instructions				1/2
G80	Perła			
260cm		Optional tools : Power drill with screwdriver bit	Please follow steps	

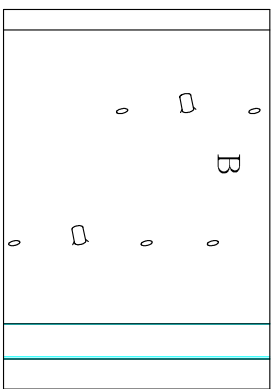
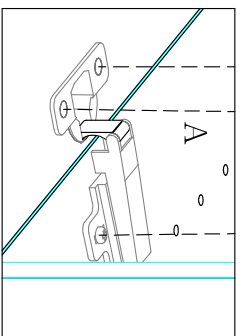
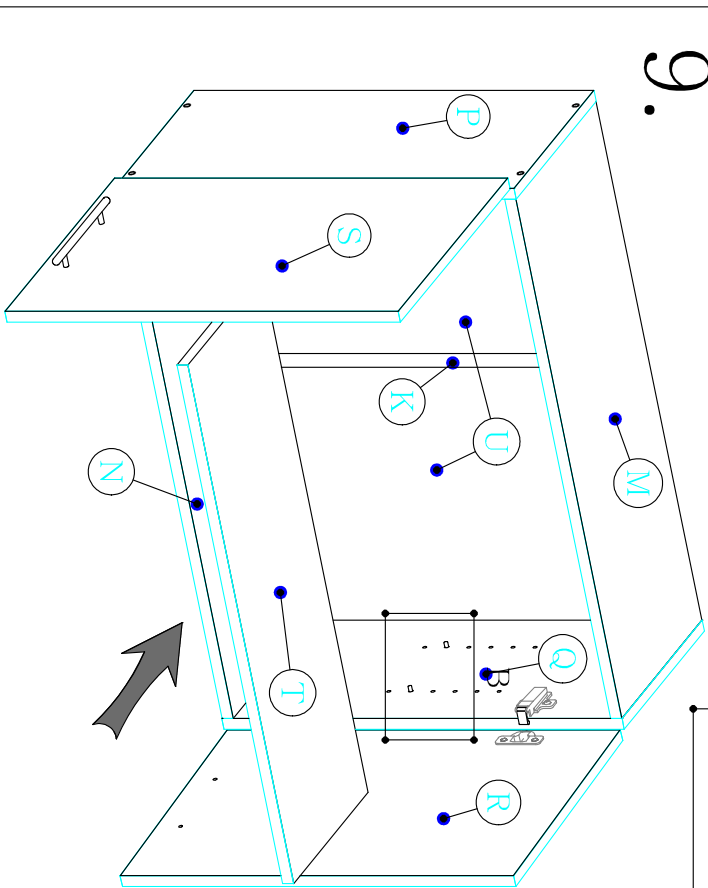
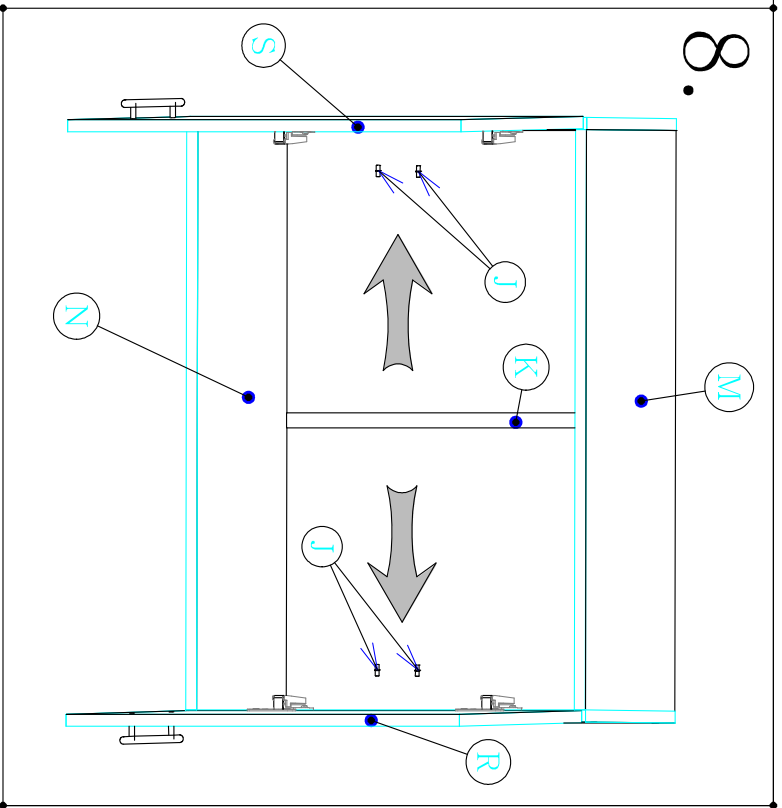
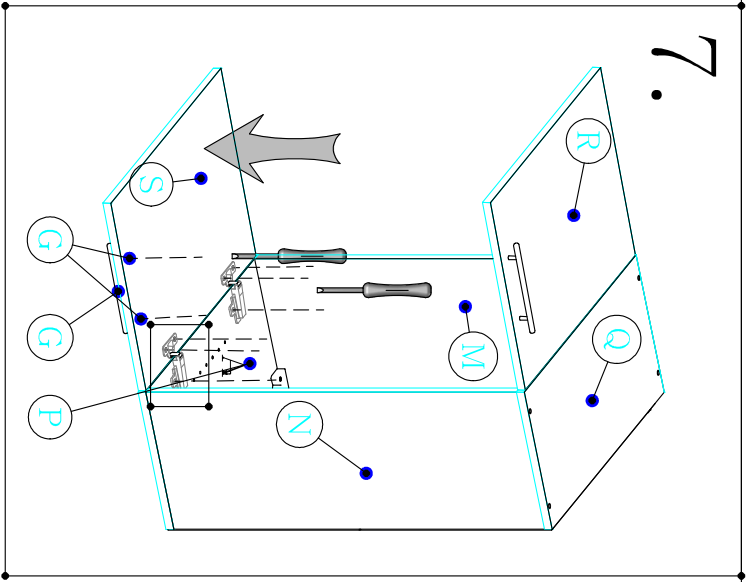
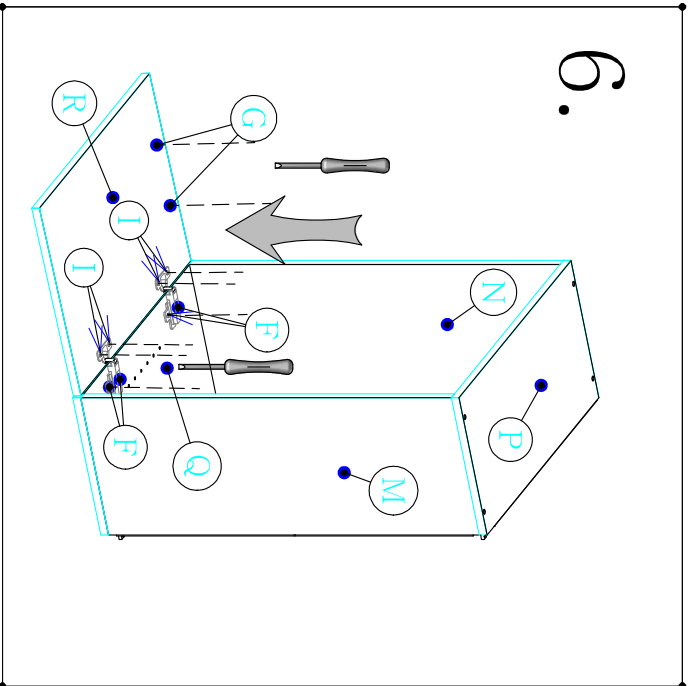

Assembly Instructions



2/2

External tools needed for assembly: hammer, screwdriver

G80

Optional tools :Power drill with screwdriver bit

Perla

Please follow steps

260cm

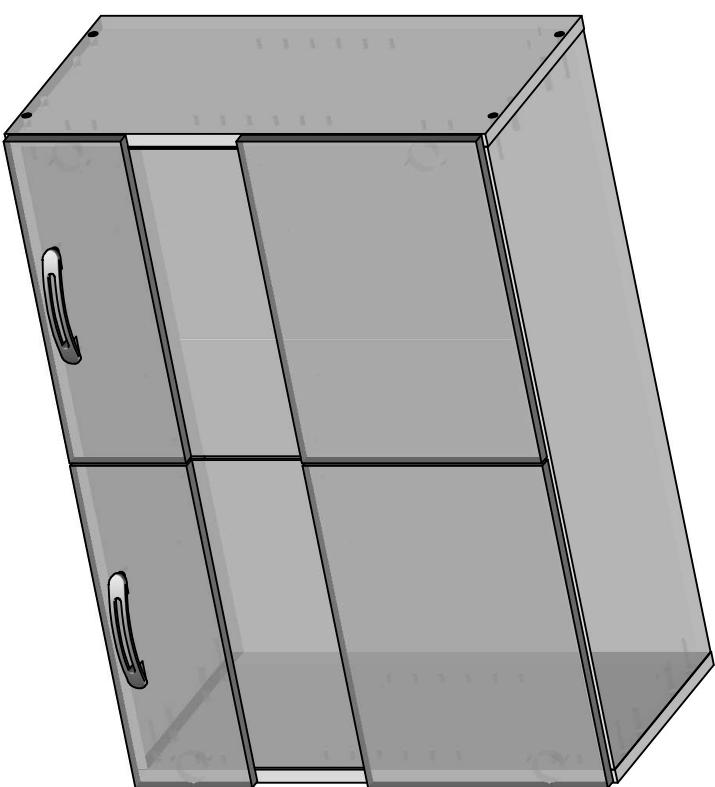
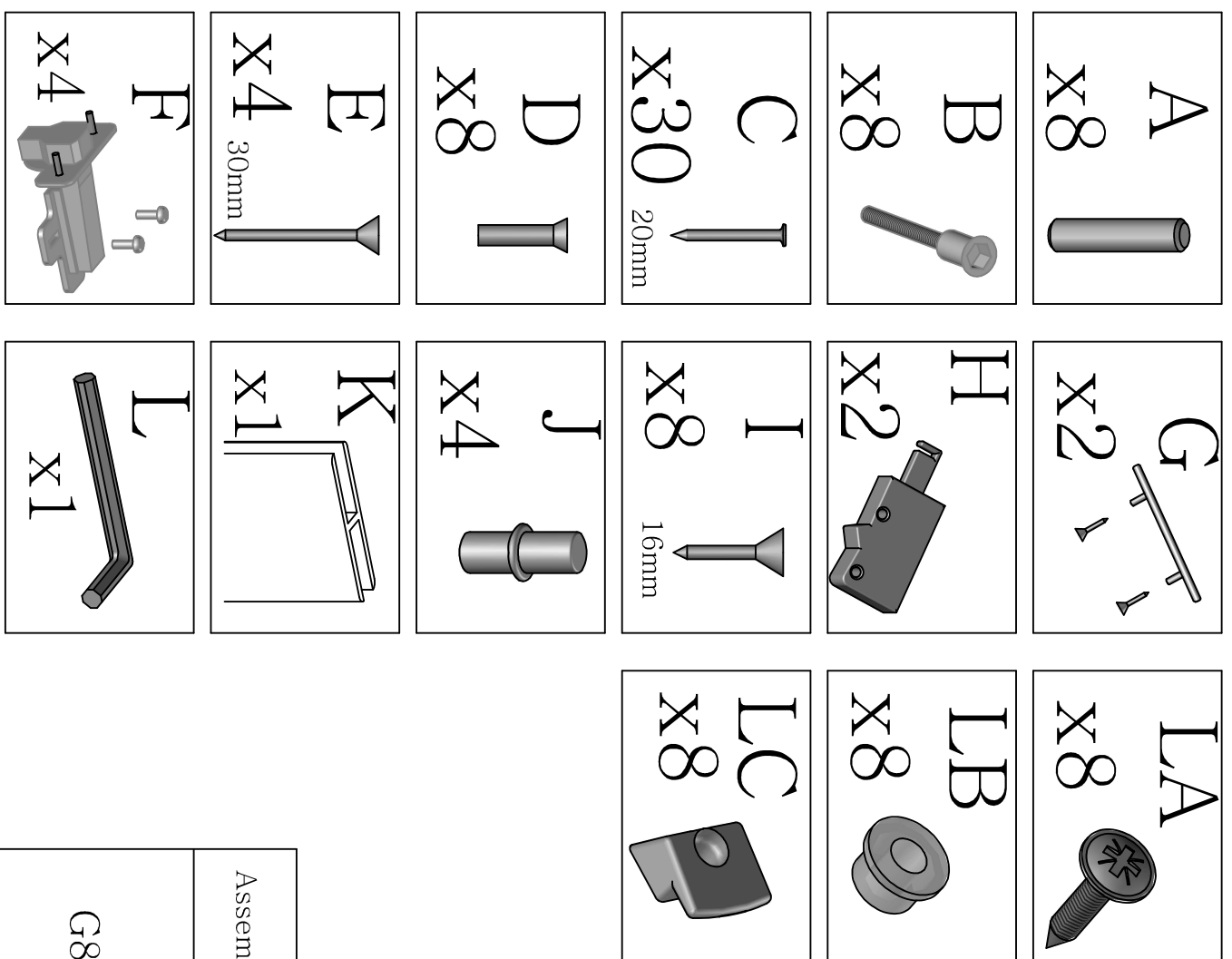

Assembly Instructions



External tools needed for assembly: hammer, screwdriver

Optional tools: Power drill with screwdriver bit

G80Wk

Please follow steps

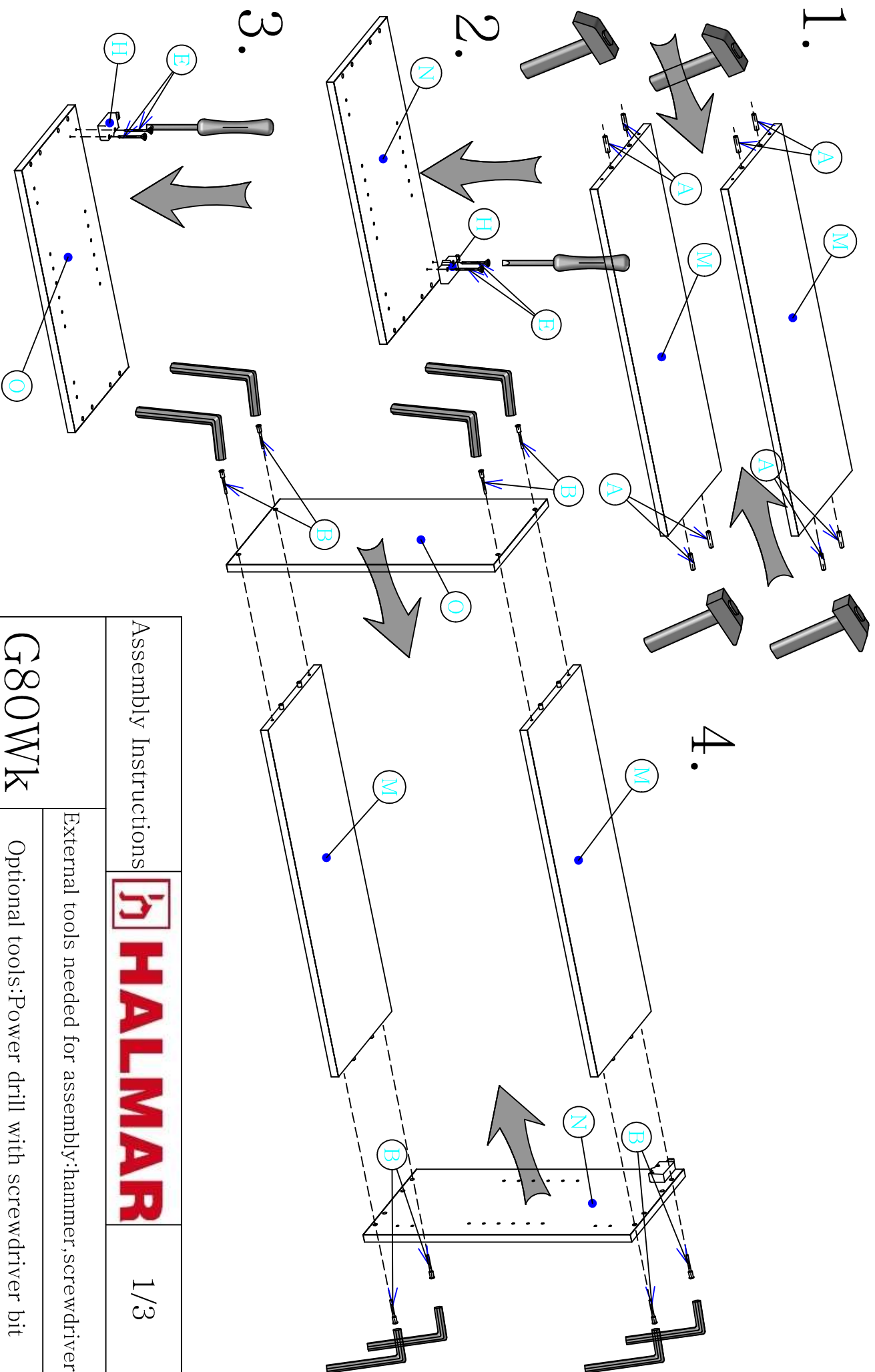

Assembly Instructions



1/3

G80Wk

External tools needed for assembly: hammer, screwdriver

Optional tools: Power drill with screwdriver bit

Please follow steps

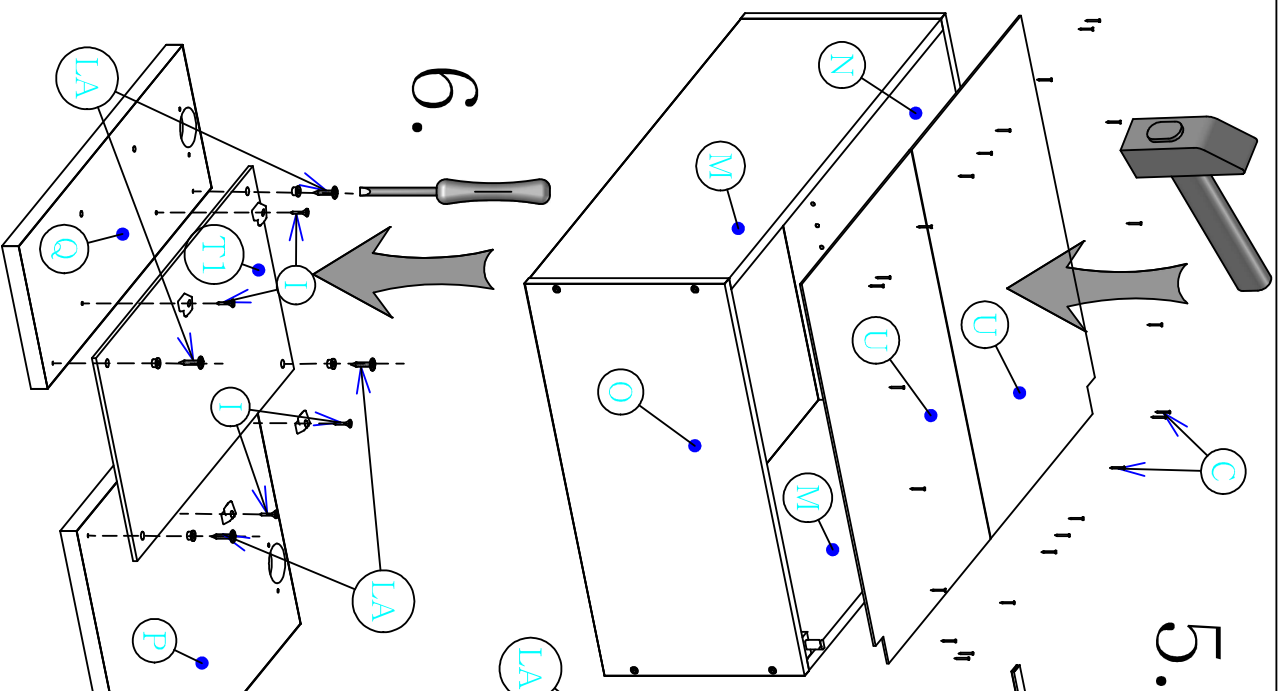

5.

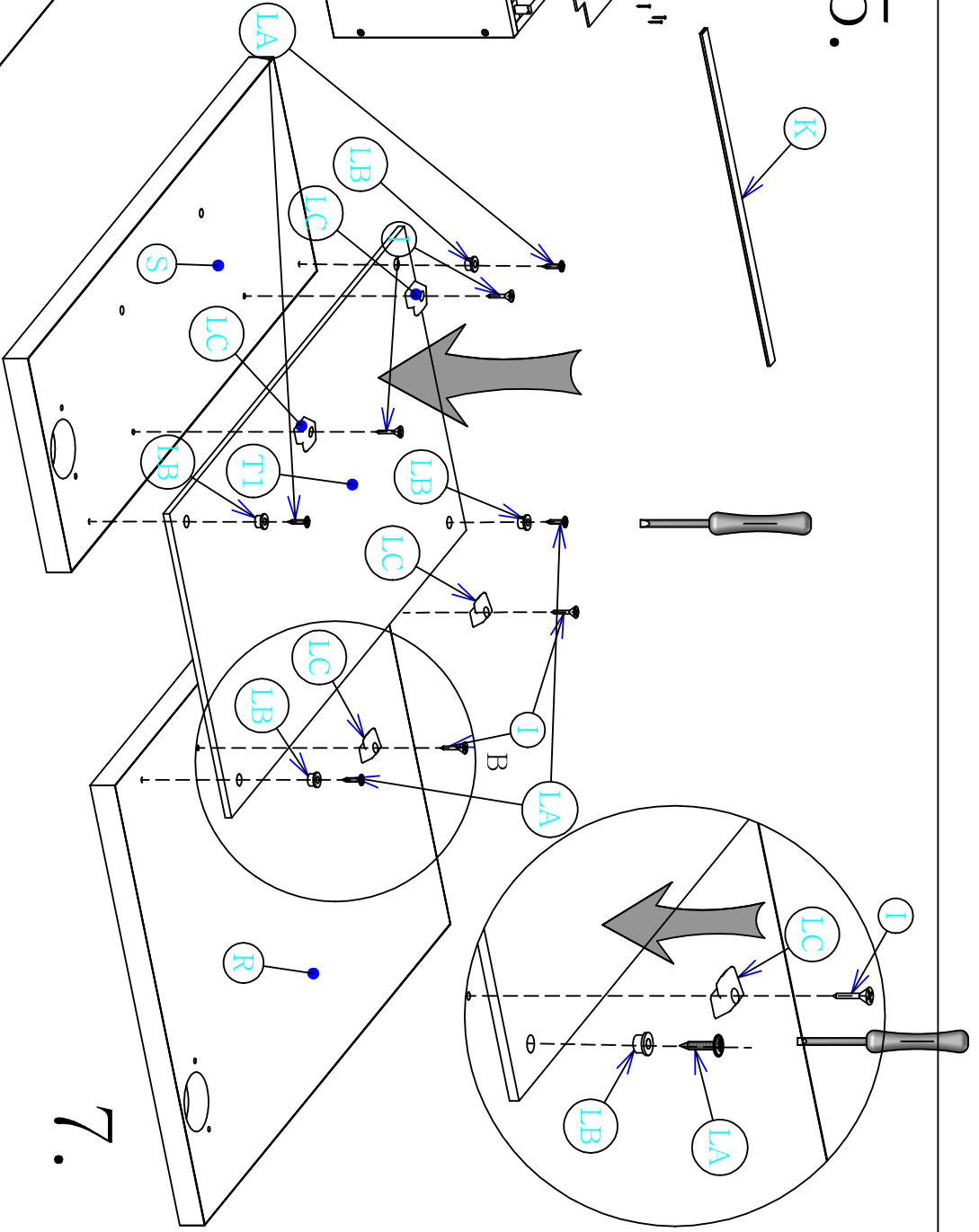

6.

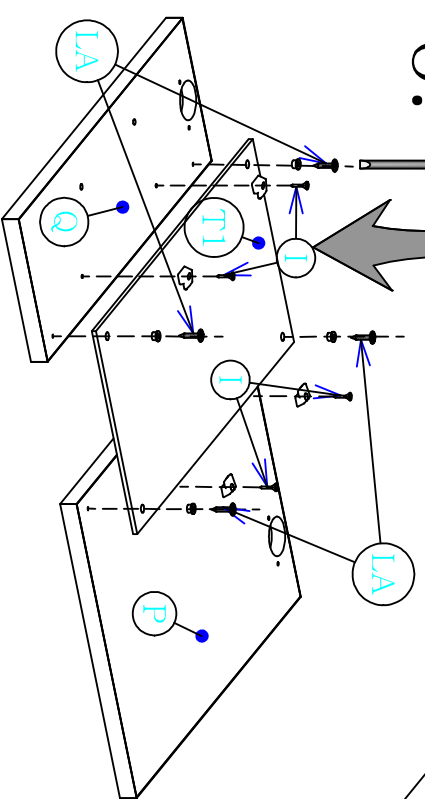

7.

Assembly Instructions



2/3

External tools needed for assembly:hammer,screwdriver

G80Wk

Optional tools:Power drill with screwdriver bit

Please follow steps

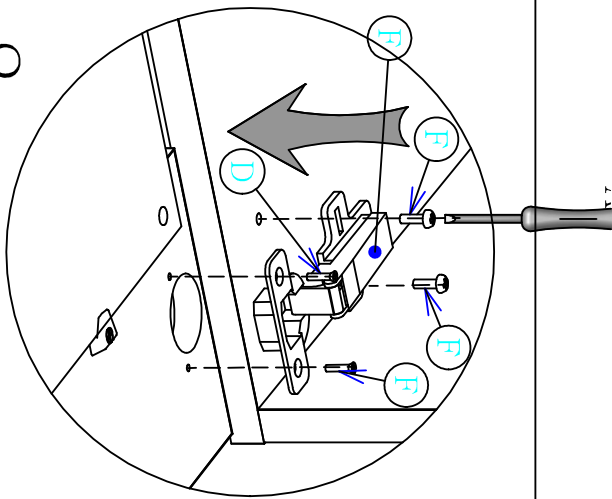

8.

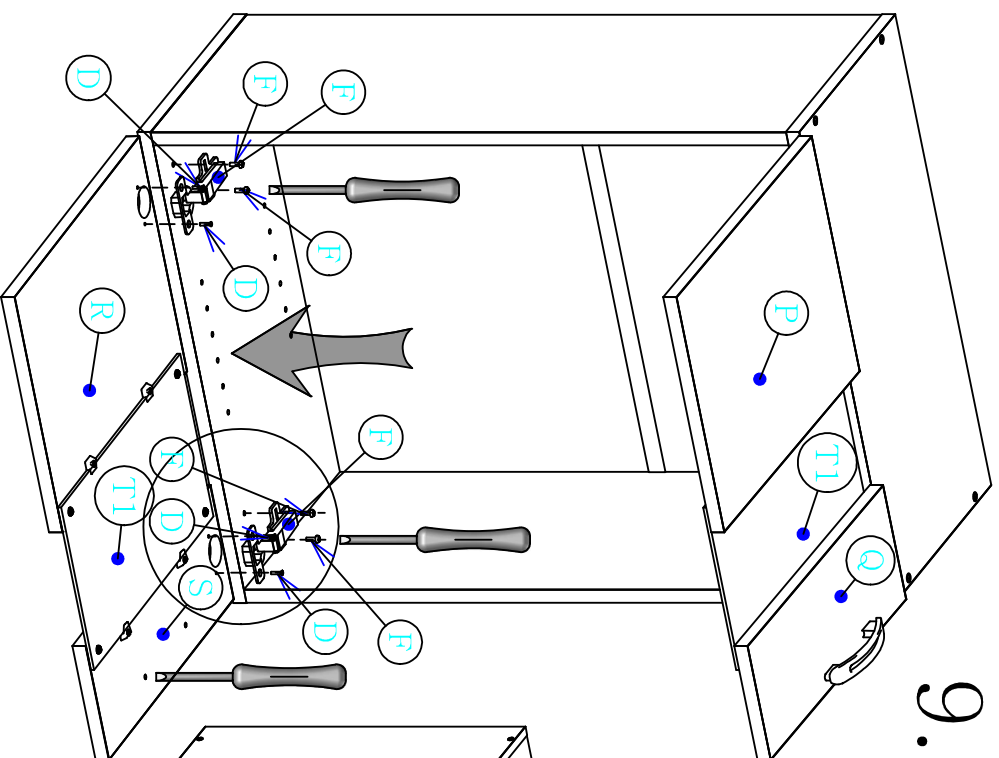
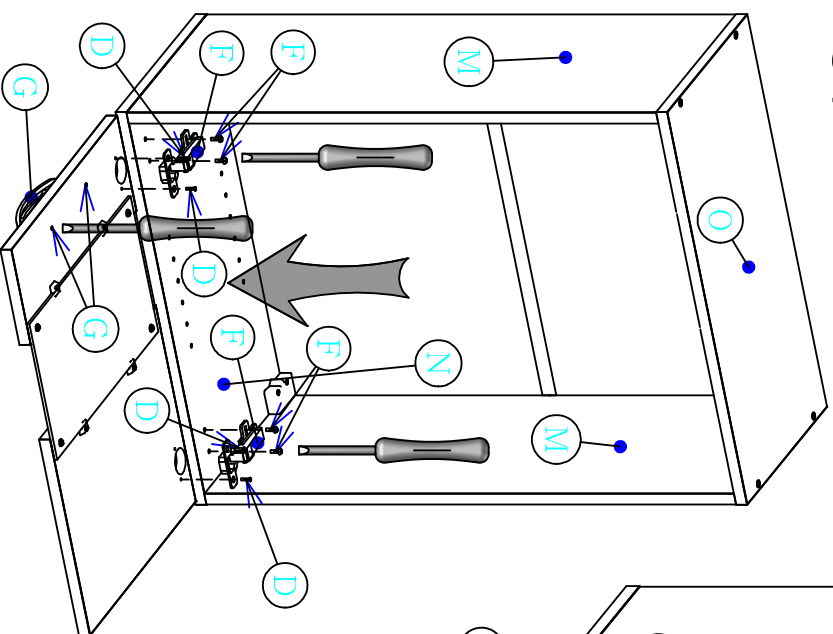

9.

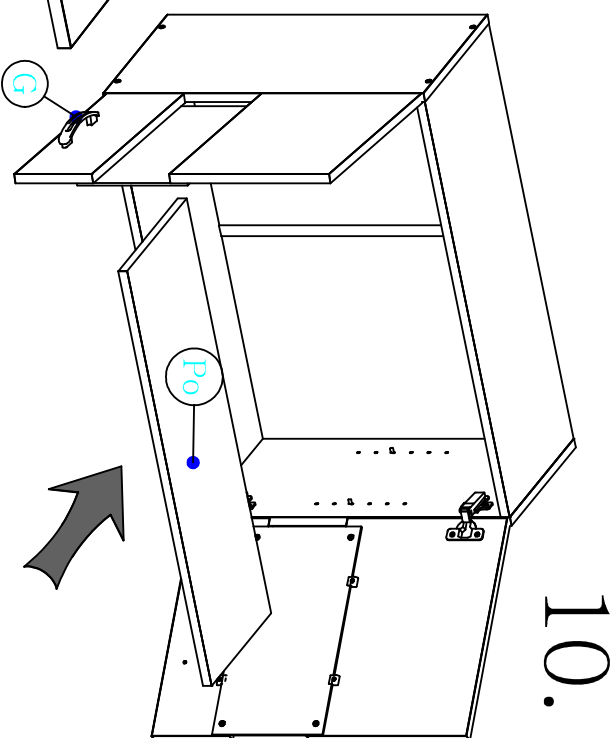

10.

Assembly Instructions



3/3

External tools needed for assembly:hammer,screwdriver

G80Wk

Optional tools:Power drill with screwdriver bit

Please follow steps