

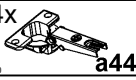

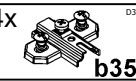



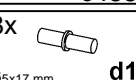
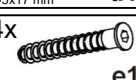
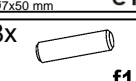
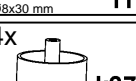

Ø10 mm
Ø 5 mm

- 4x  **a44**
- 4x  **b35**
- 2x  **c488**
- 8x  **d1**
Ø5x17 mm
- 4x  **e1**
Ø7x50 mm
- 8x  **f1**
Ø8x30 mm
- 4x  **k27**
- 8x  **l2**
- 8x  **p51**
Ø3.5x15 mm
- 2x  **p131**
Ø4x16 mm
- 4x  **r1**
Ø15x12 mm #16
- 4x  **r42**
- 4x  **s2**
Ø16
- 1x  **z1**

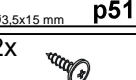
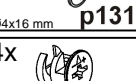
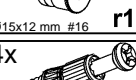
A	B	C1	C2	C3	D
1	S295-0001	784	396	19	2/2
2	S295-1001	773	350	16	1/2
3	S295-1002	773	350	16	1/2
4	S295-2001	820	380	28	2/2
5	S295-2002	800	350	16	2/2
6	S295-3001	766	320	16	1/2
7	S295-9301	783	777	2,5	2/2

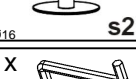
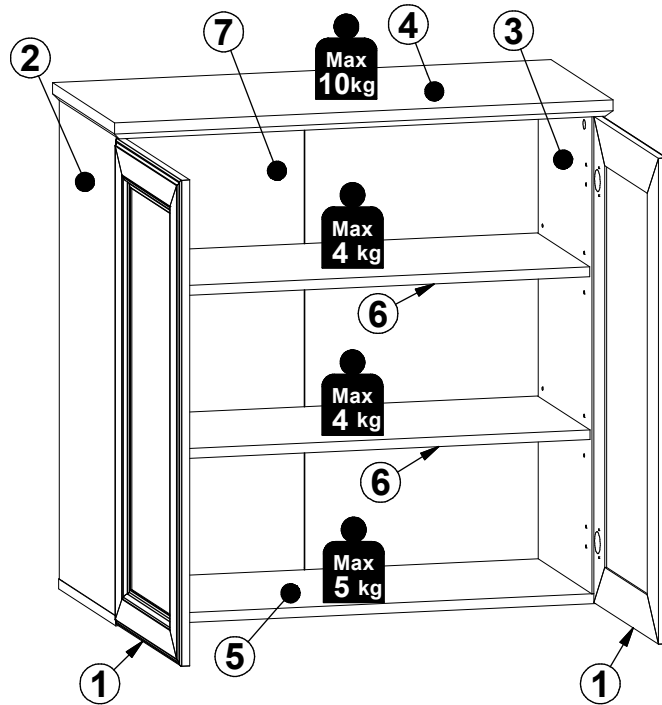

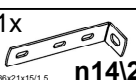
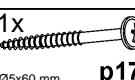
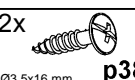
- 1x  **f35**
Ø10x50 mm
- 1x  **n142**
96x21x15/1,5
- 1x  **p17**
Ø5x60 mm
- 2x  **p38**
Ø3.5x16 mm

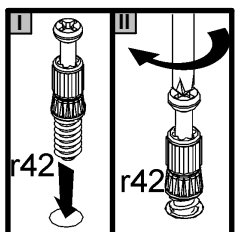
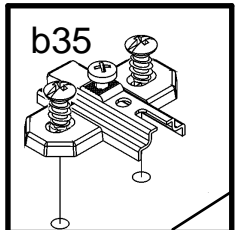
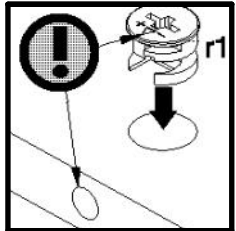
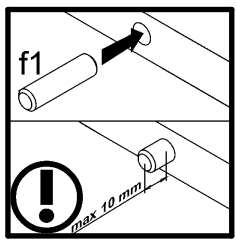
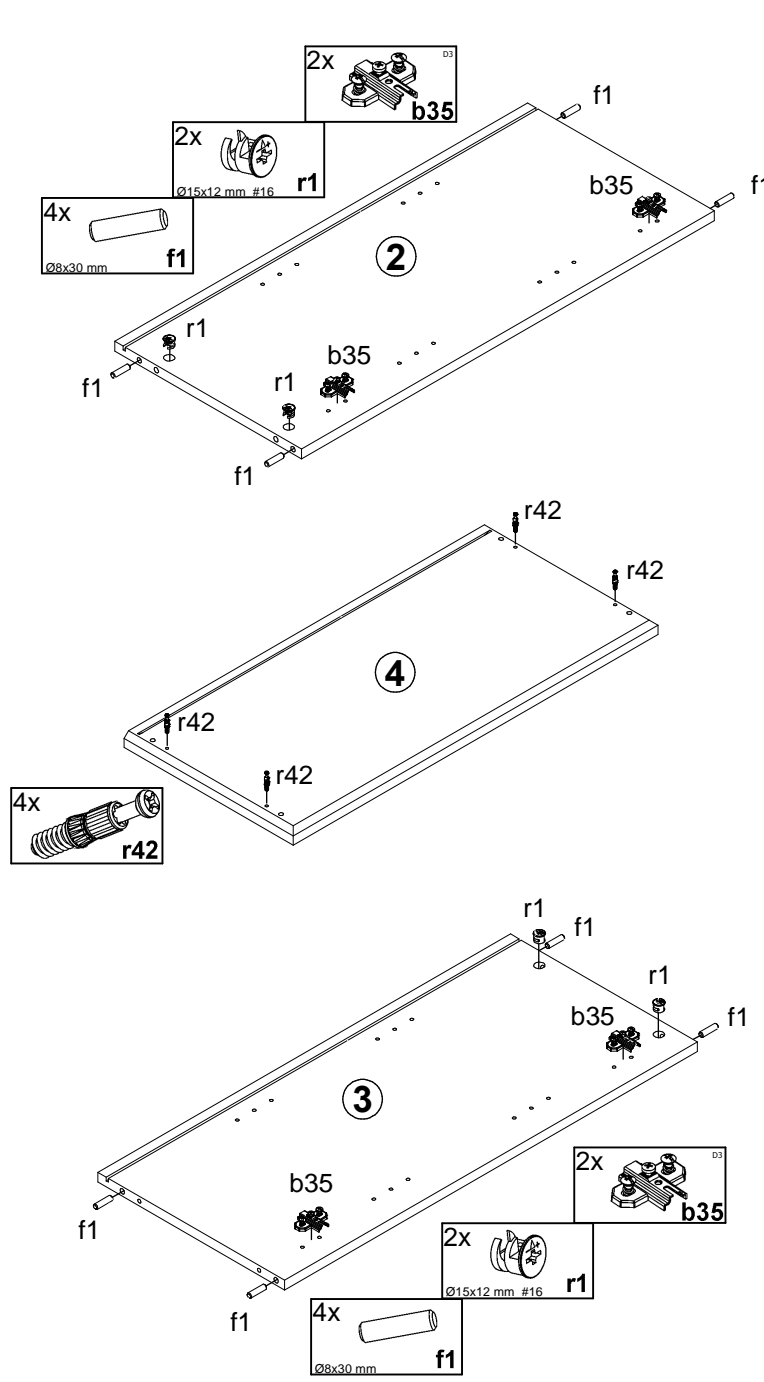

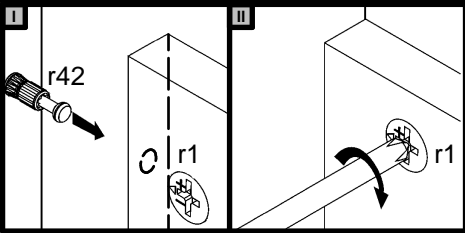

2

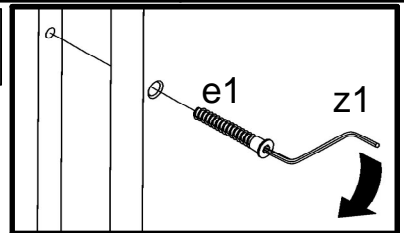
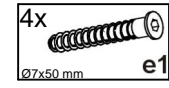
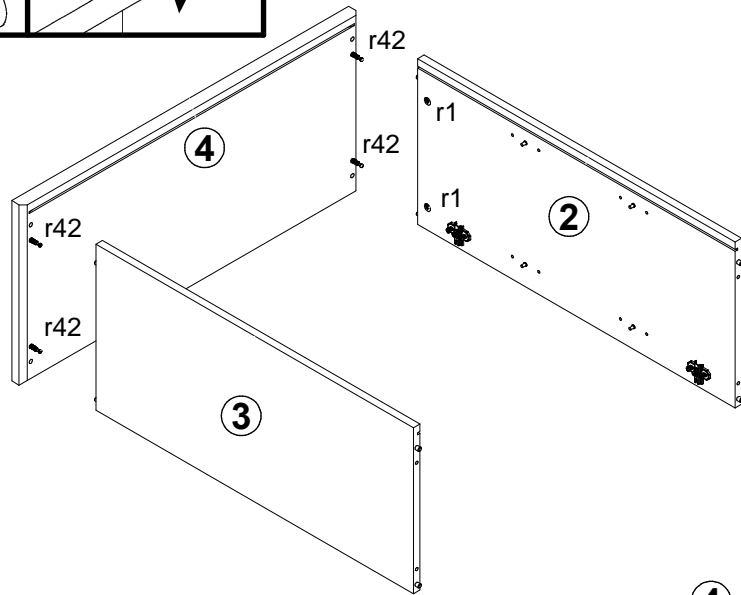

3

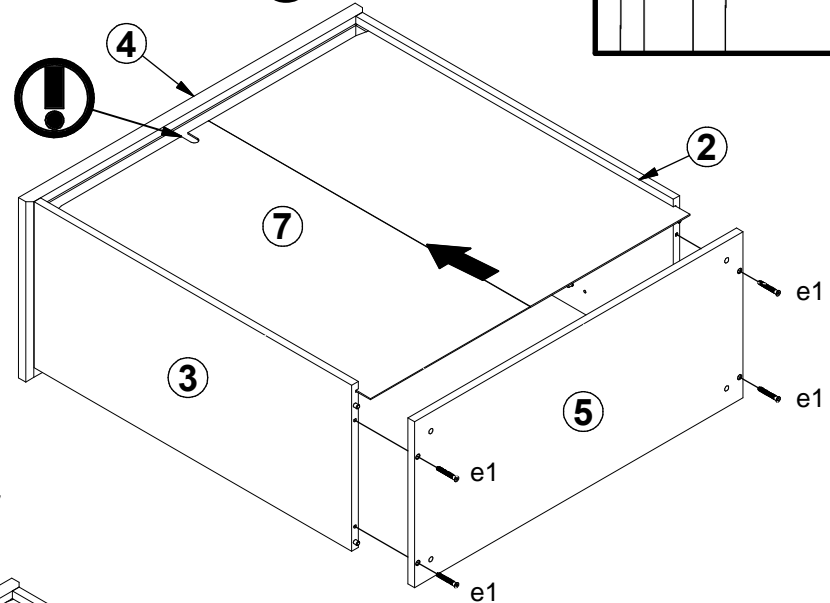

4

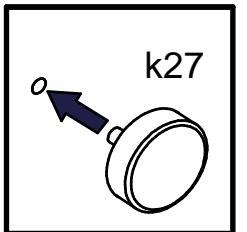
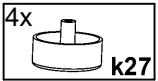
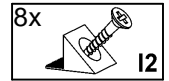
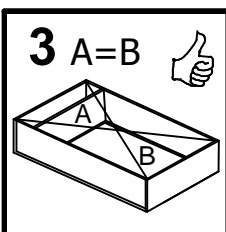
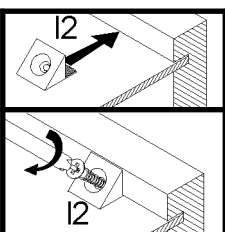
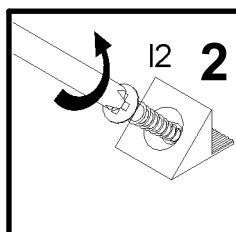
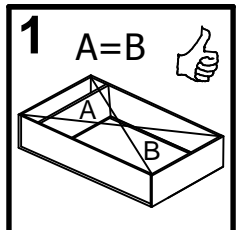
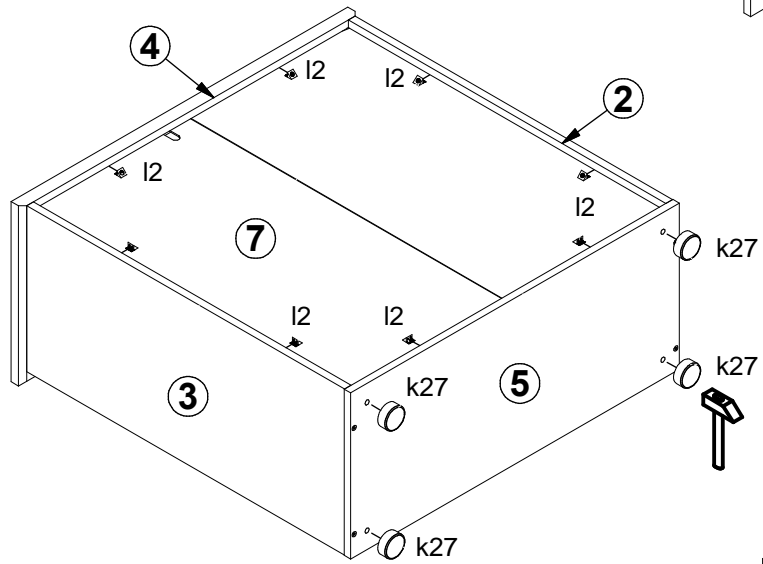

5

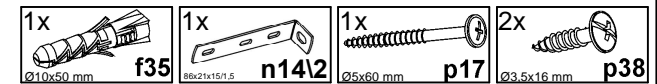
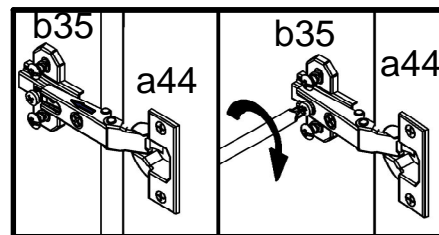
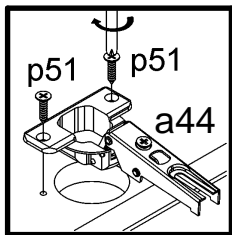
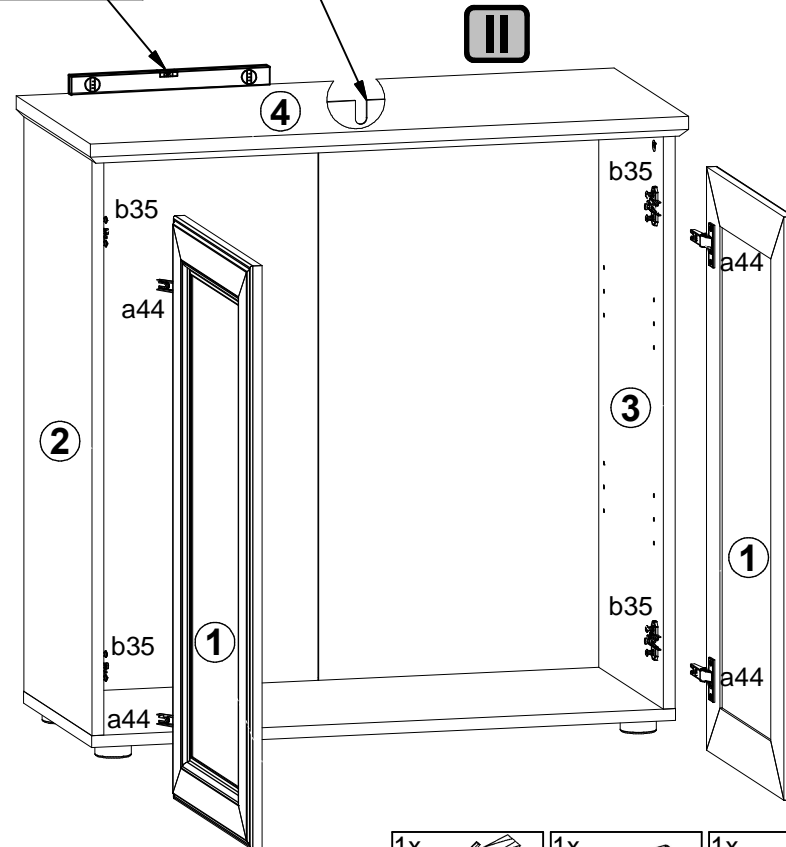
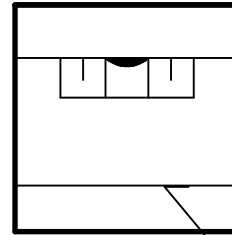
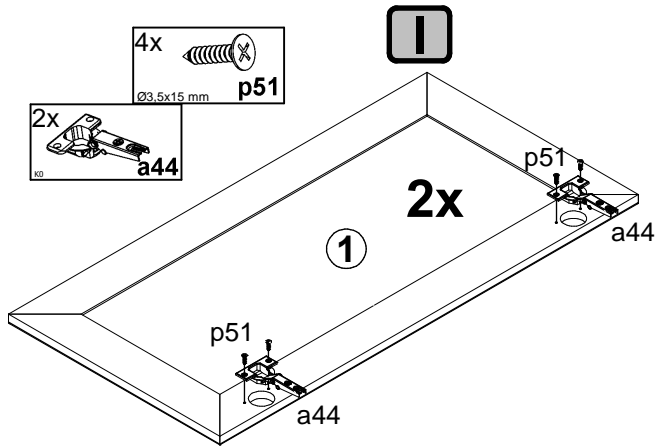
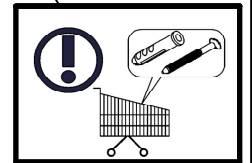
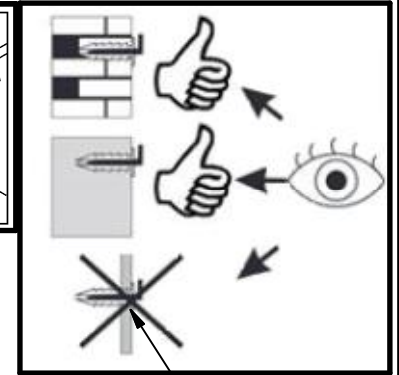
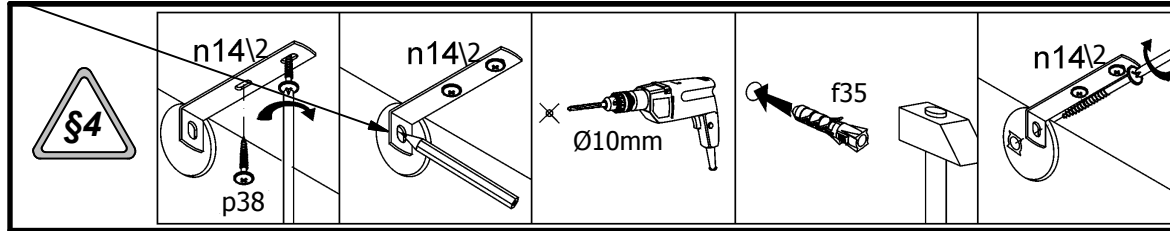

- 2x c488
- 2x p131
- 8x d1
- 4x s2

6

