

Dario

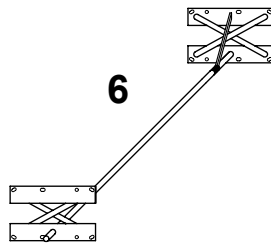

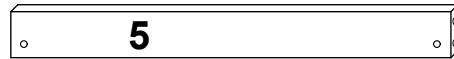

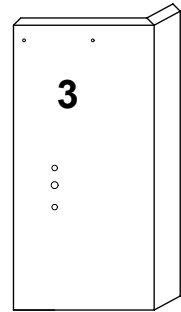
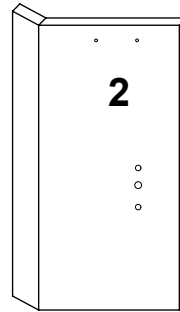
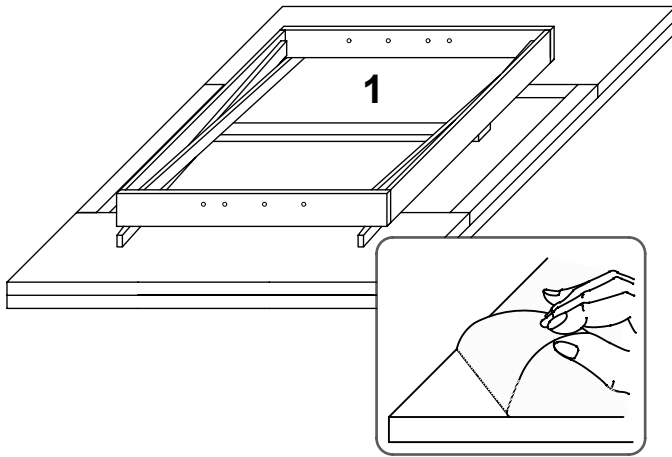
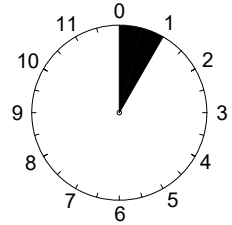
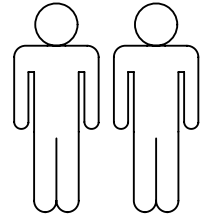
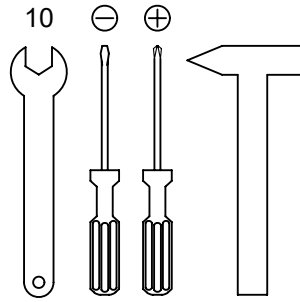
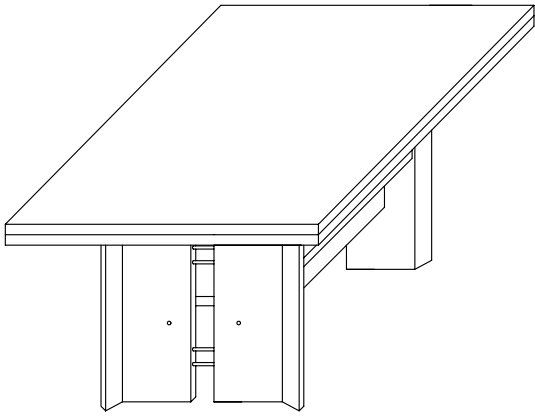
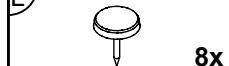
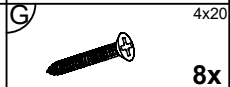
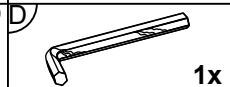
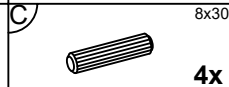
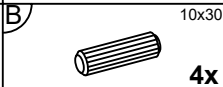
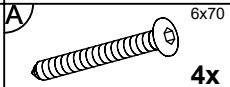
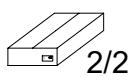
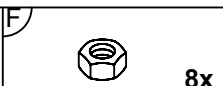
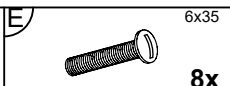
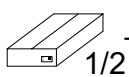

1	1x	1/2
2	2x	2/2
3	2x	2/2
4	1x	2/2
5	2x	2/2
6	1x	2/2

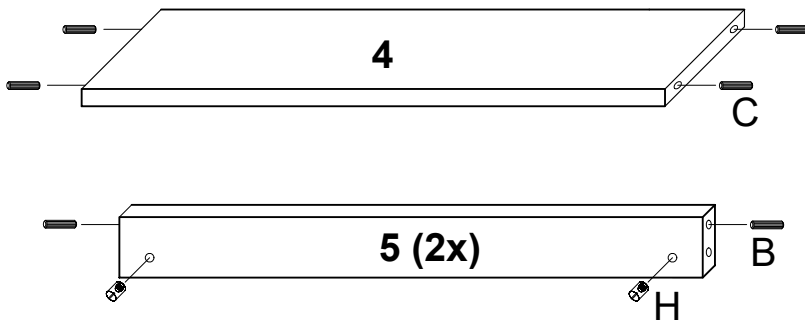

I.

1.



B		10x30
		4x
C		8x30
		4x
H		
		4x

2.



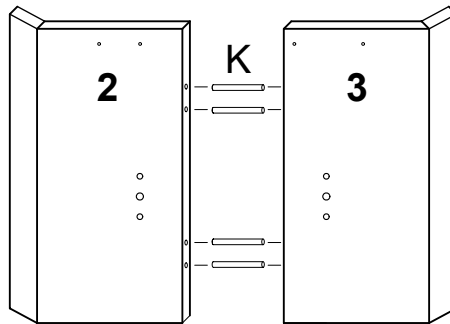

(2x)

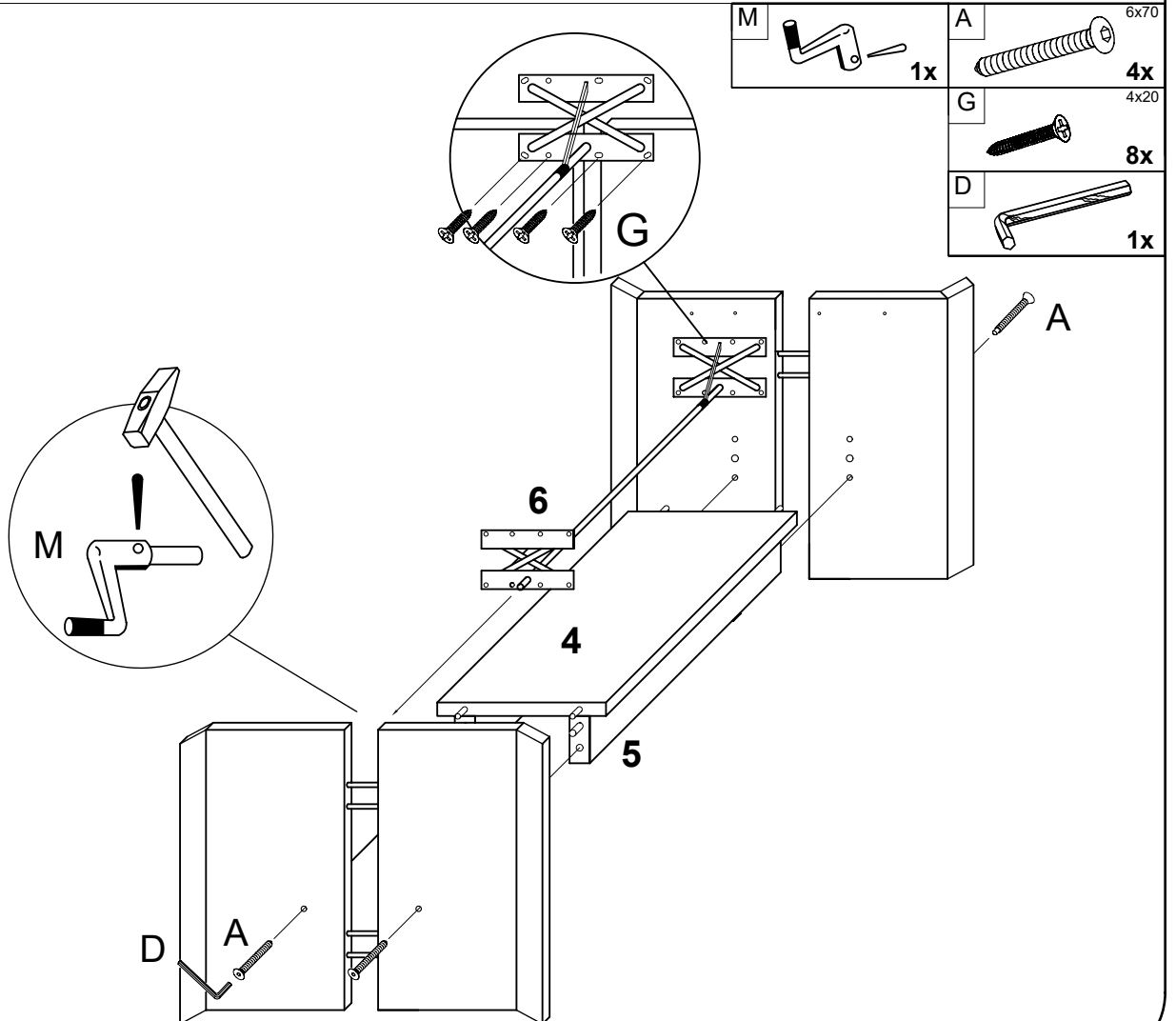

K		
		8x



3.



M		1x
A		6x70
		4x
G		4x20
		8x
D		
		1x

II.

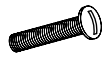
4.

E		6x35
		8x
F		8x
L		8x

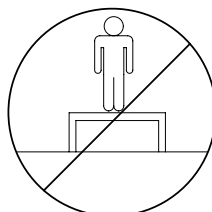
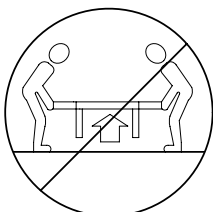
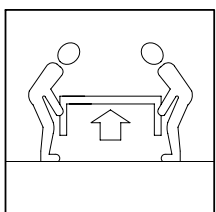
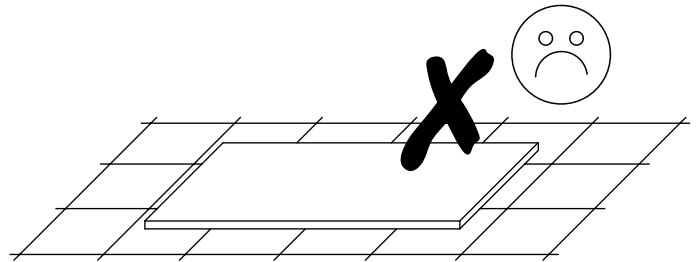
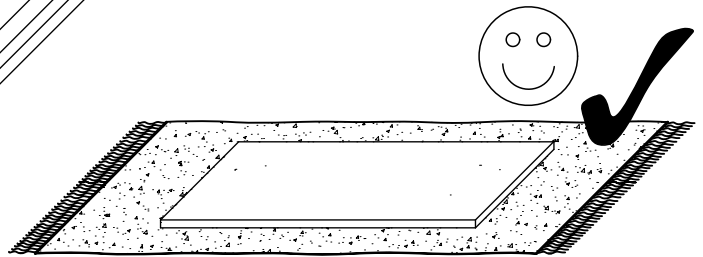
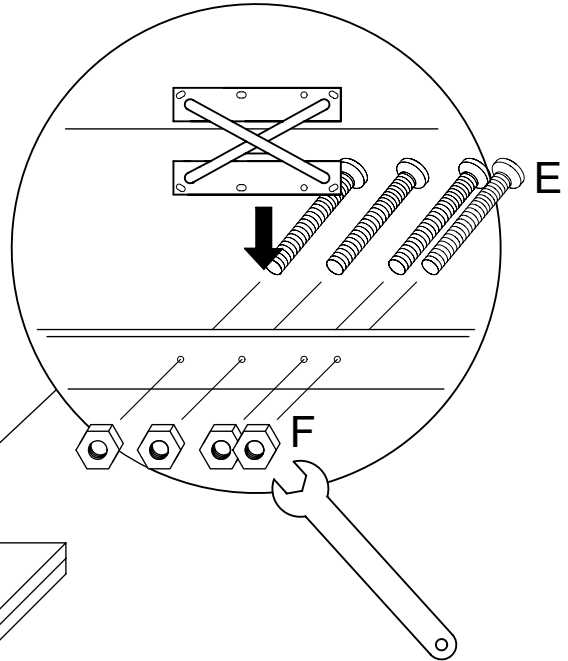
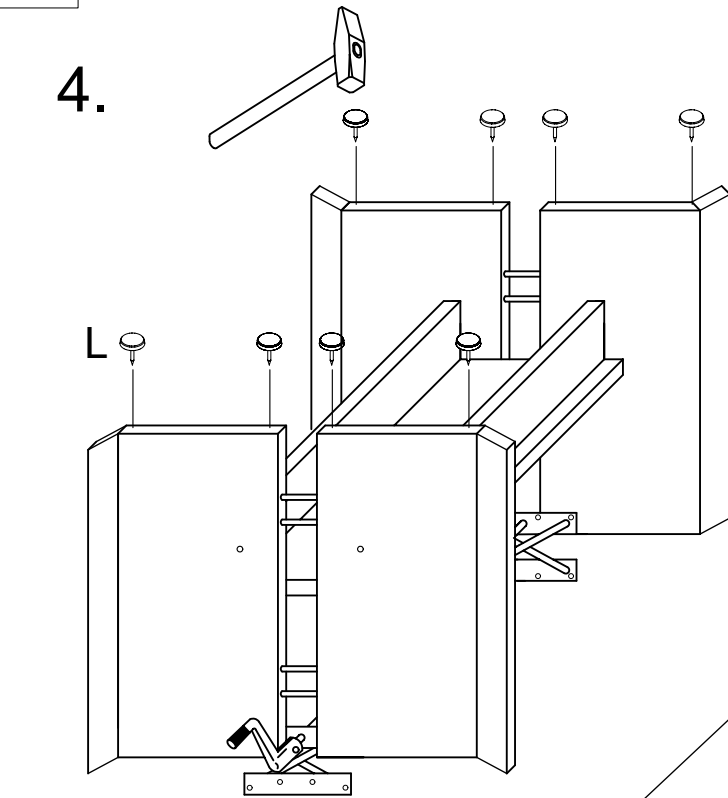

LE TRI
+ FACILE



BAC
DE
TRI