

Massa

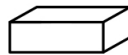

1 / 1	1	x1	Ø80x18
1 / 1	2	x1	Ø60x18
1 / 1	3	x3	382x238x40
1 / 1	4	x3	432x338x40
1 / 1	5	x2	80x80x13

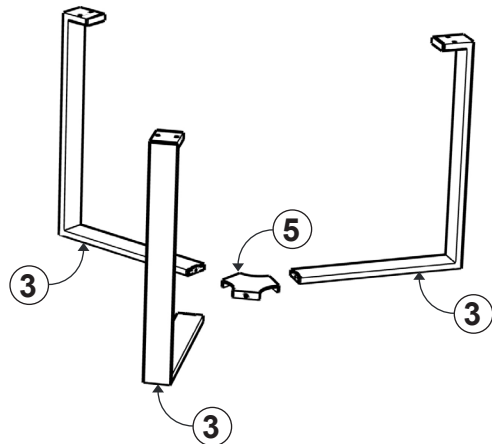
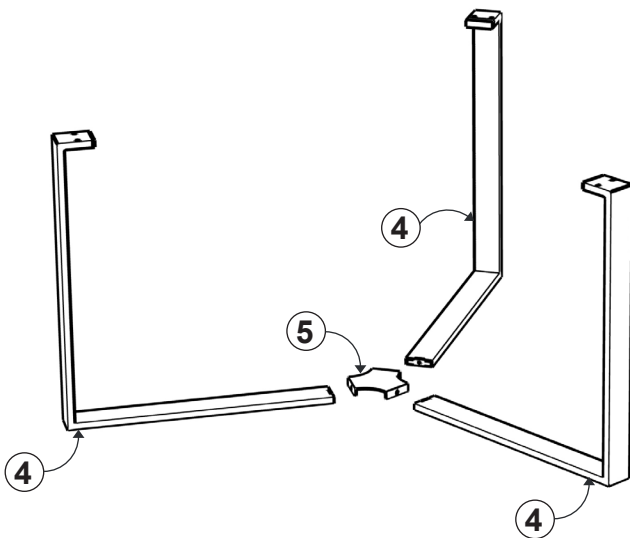
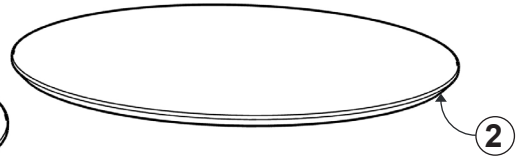
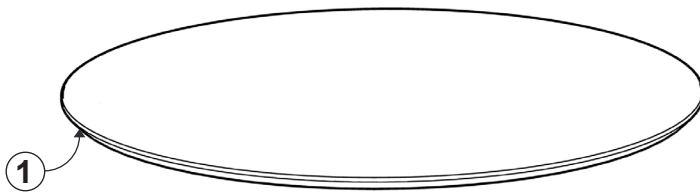
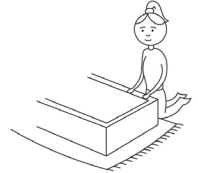
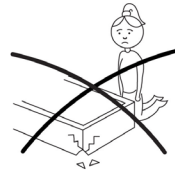
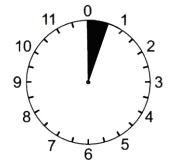
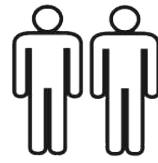
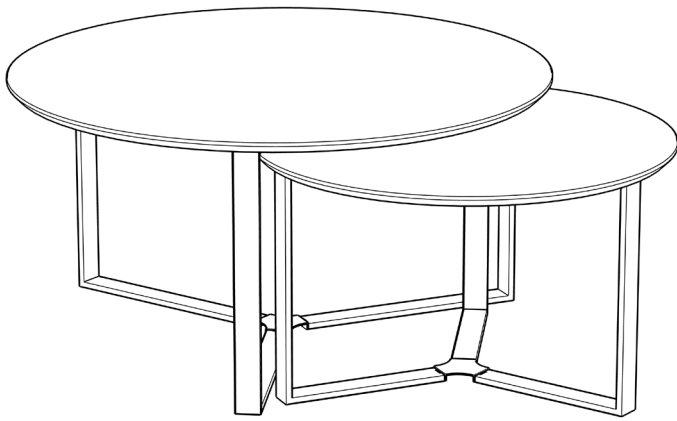
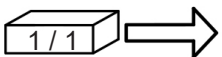

A

M6x16

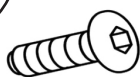

x6

B

M6x20

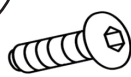

x12

C

Ø16x6

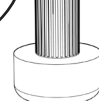

x12

D

SW4

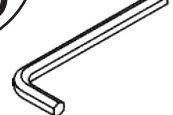

x1

I.

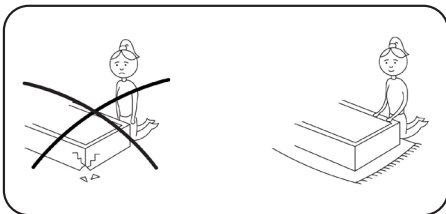
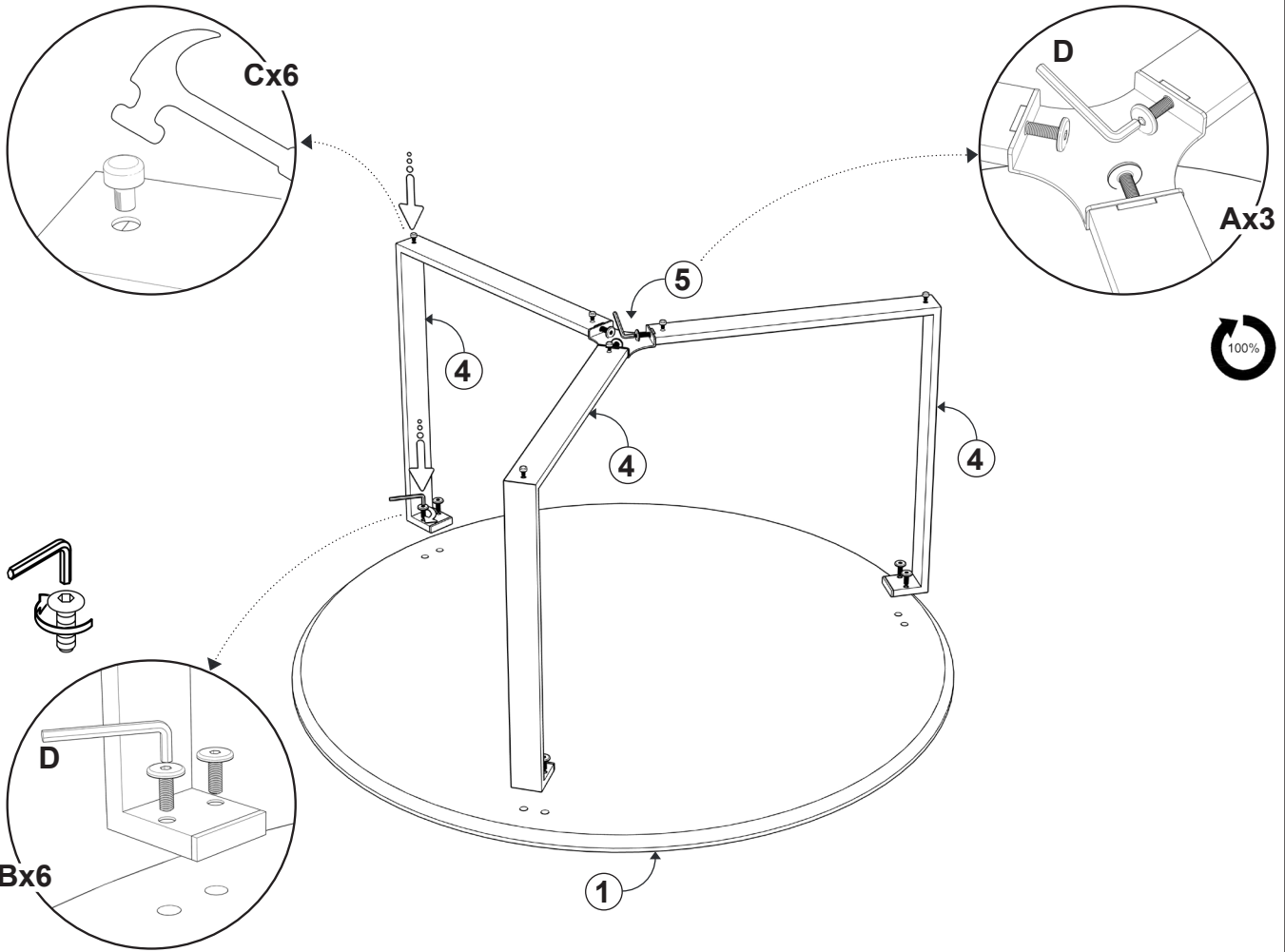
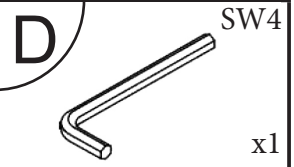
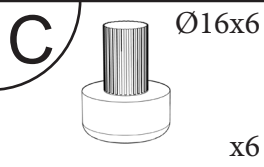
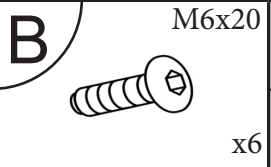
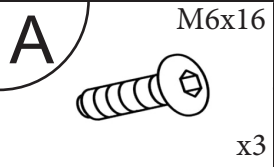

II.

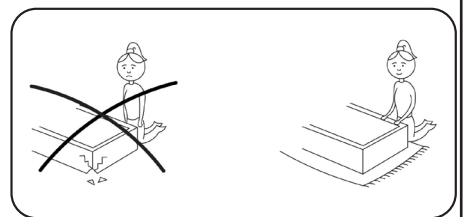
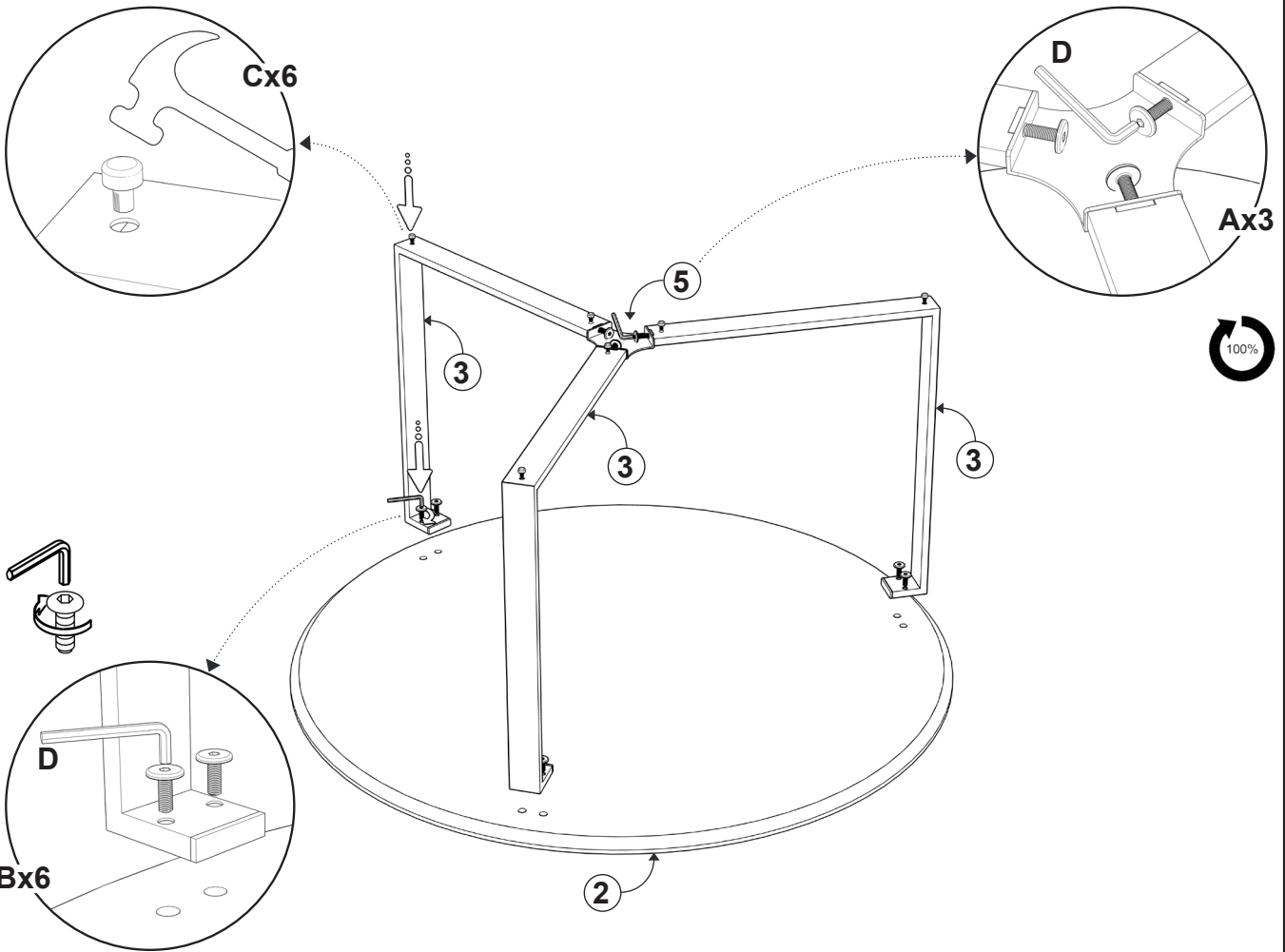
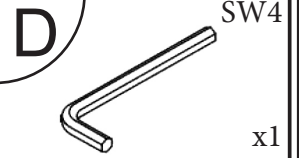
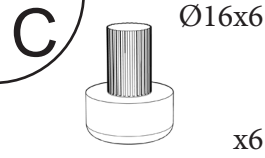
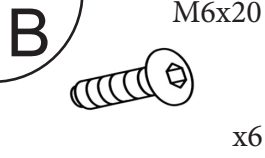
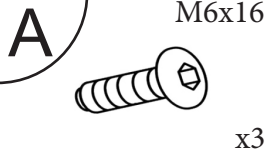

III.

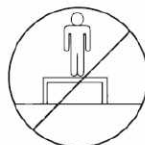
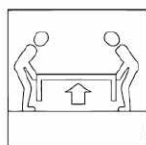
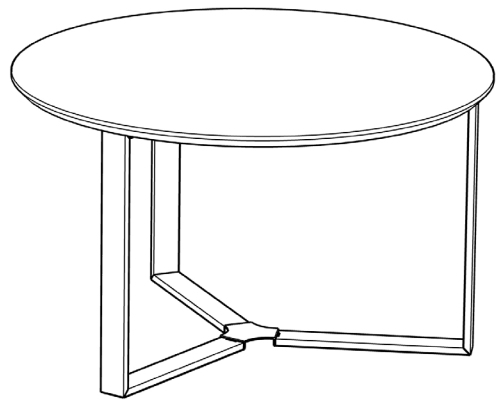
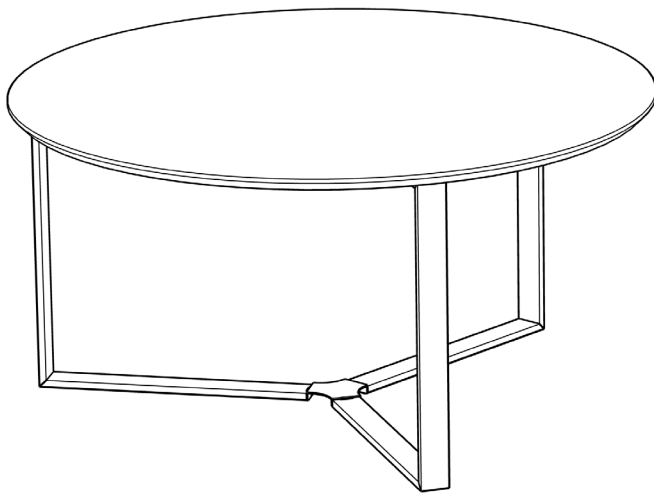
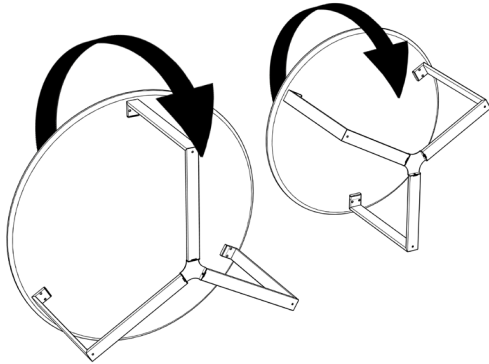

LE TRI
+ FACILE



+

