

SC-258
NINA

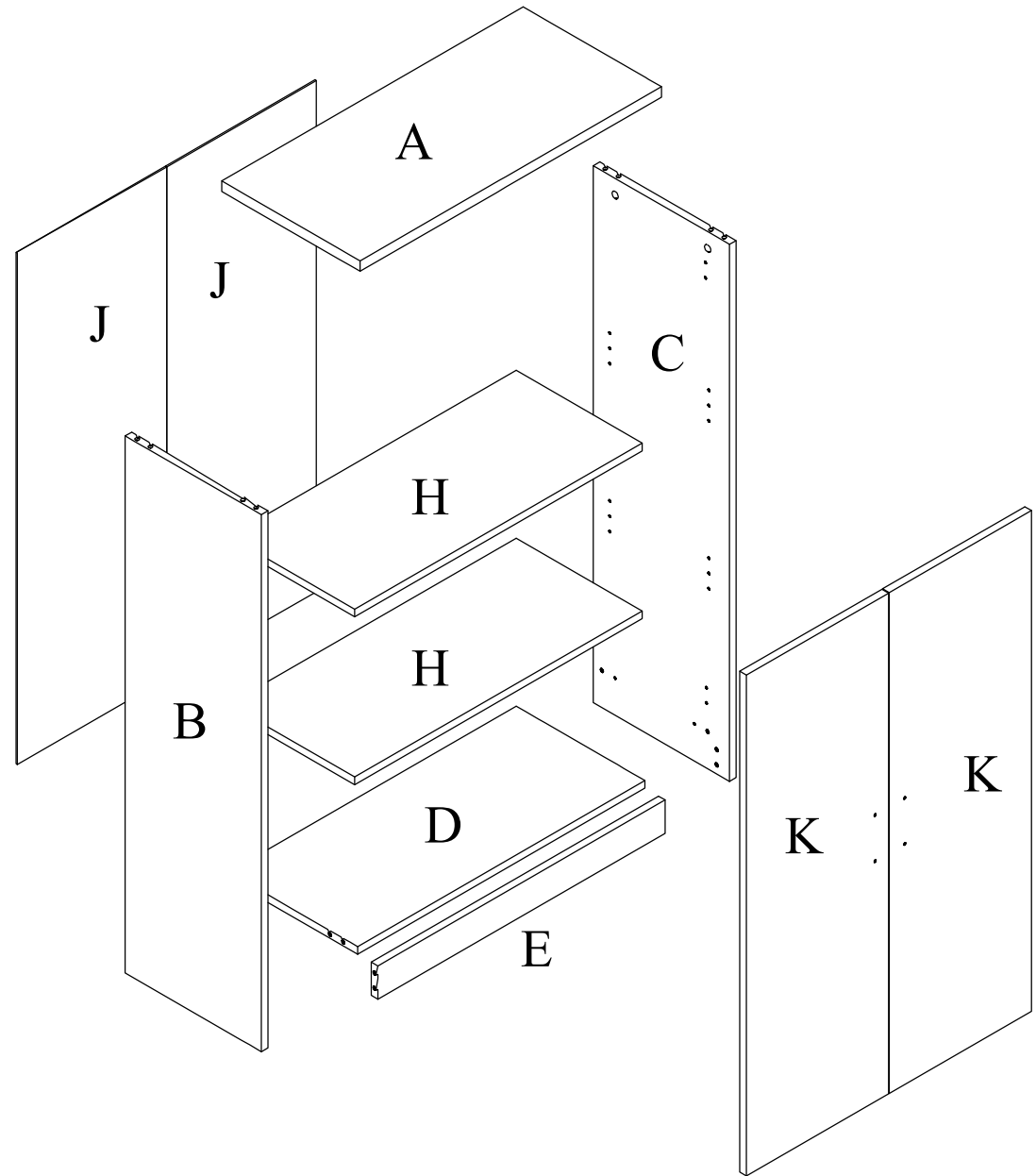

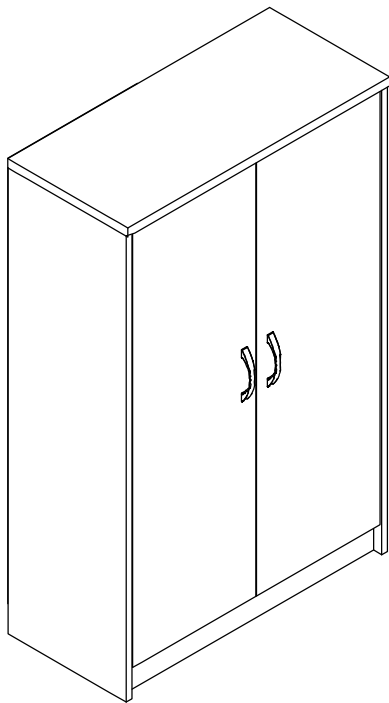

0013K	1x	0036K	4x	0014K	4x
-------	----	-------	----	-------	----

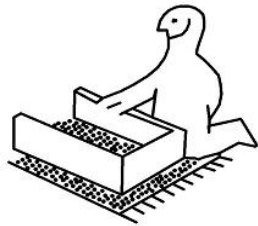
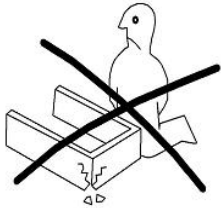
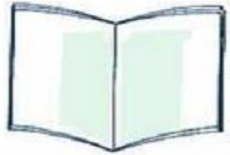
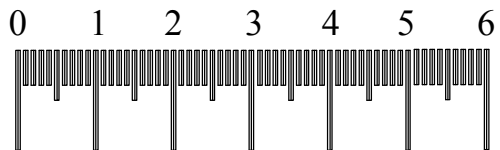
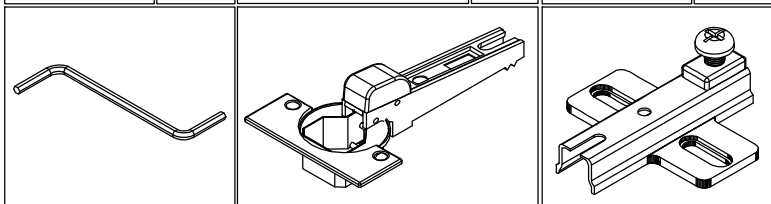

0016U	2x	0018K	8x	0019K	8x
-------	----	-------	----	-------	----

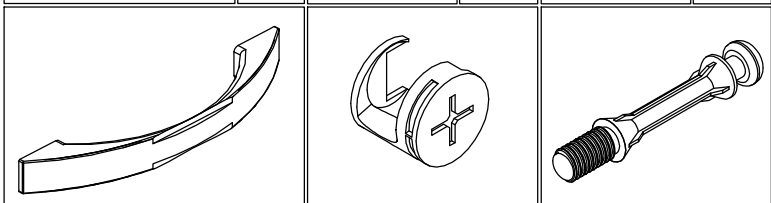

0001K	12x	0009K	8x	0016K	30x	0022V	4x
-------	-----	-------	----	-------	-----	-------	----

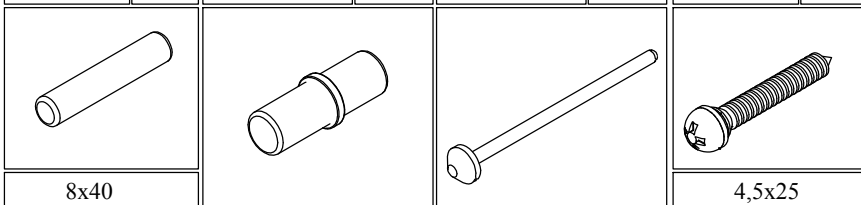

0002K	4x	0027K	1x	0024V	2x	0002V	8x
-------	----	-------	----	-------	----	-------	----

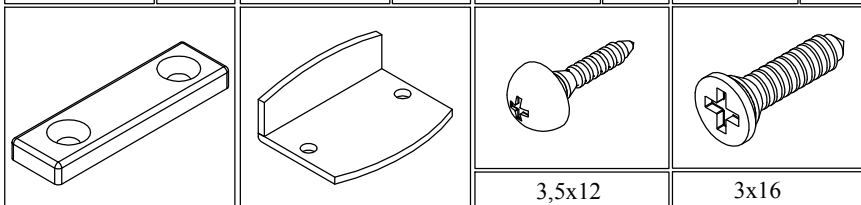

0054K	8x	0001V	16x
-------	----	-------	-----

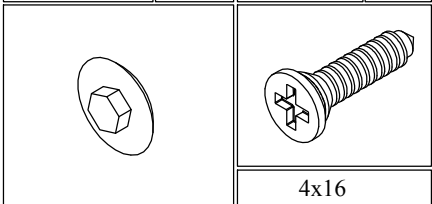

1.)

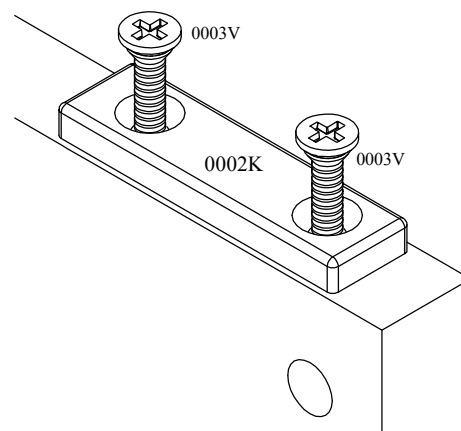
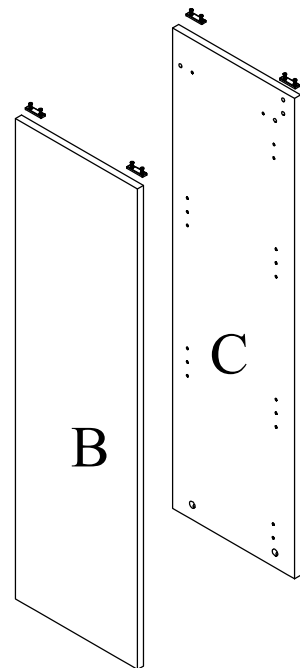
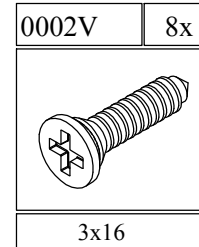
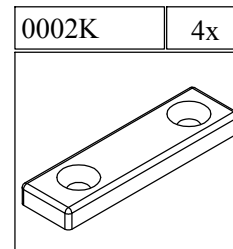

2.)

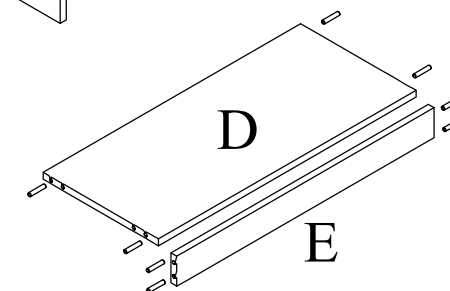
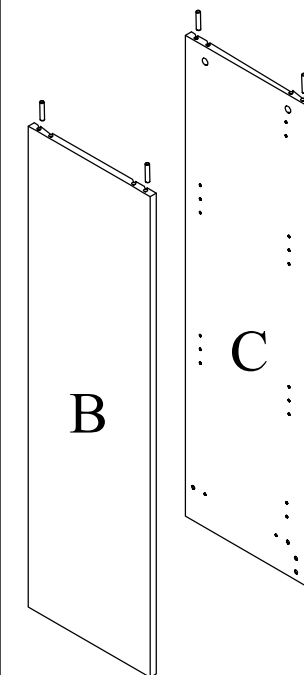
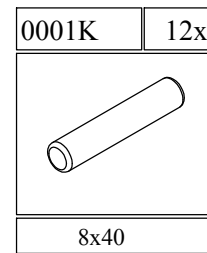
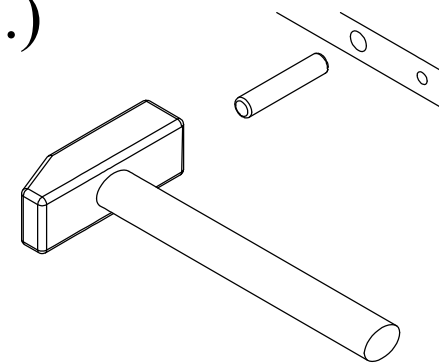

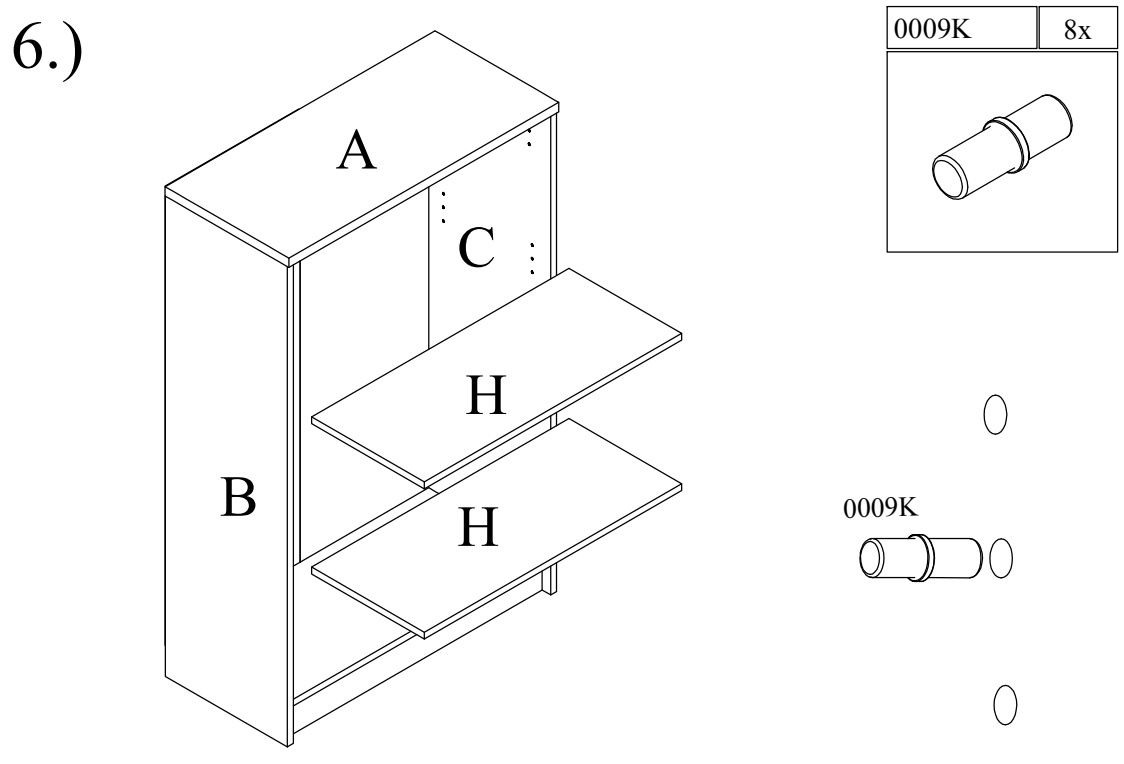
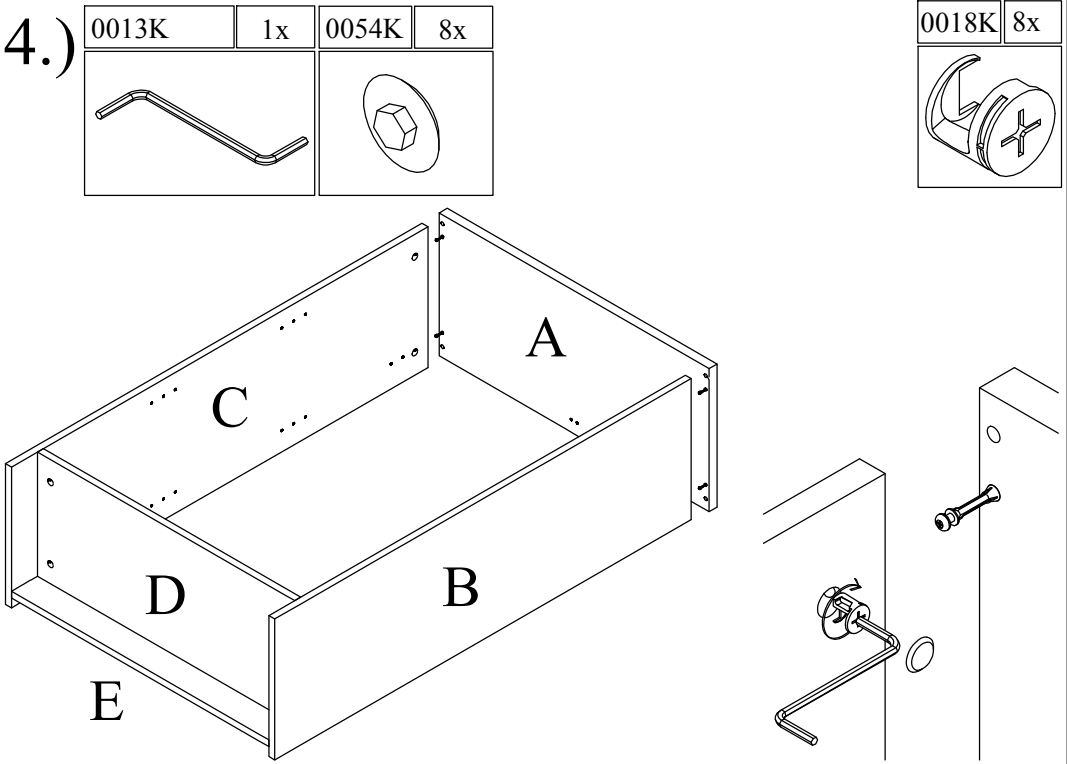
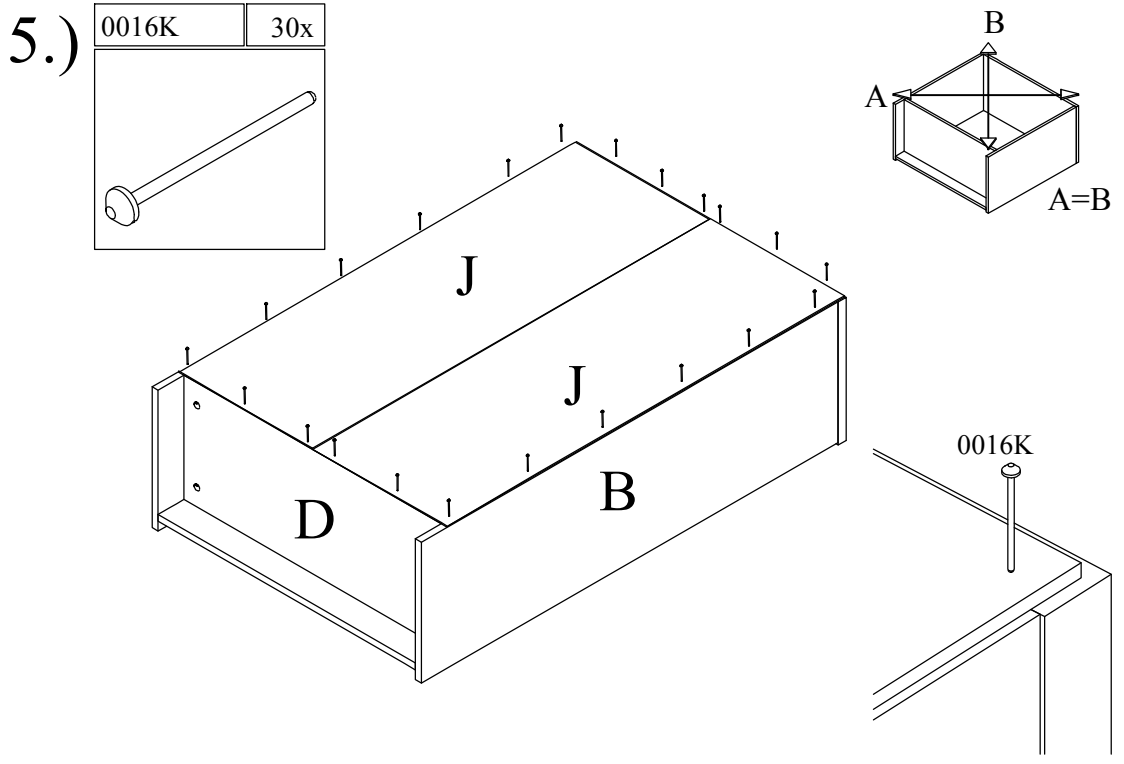
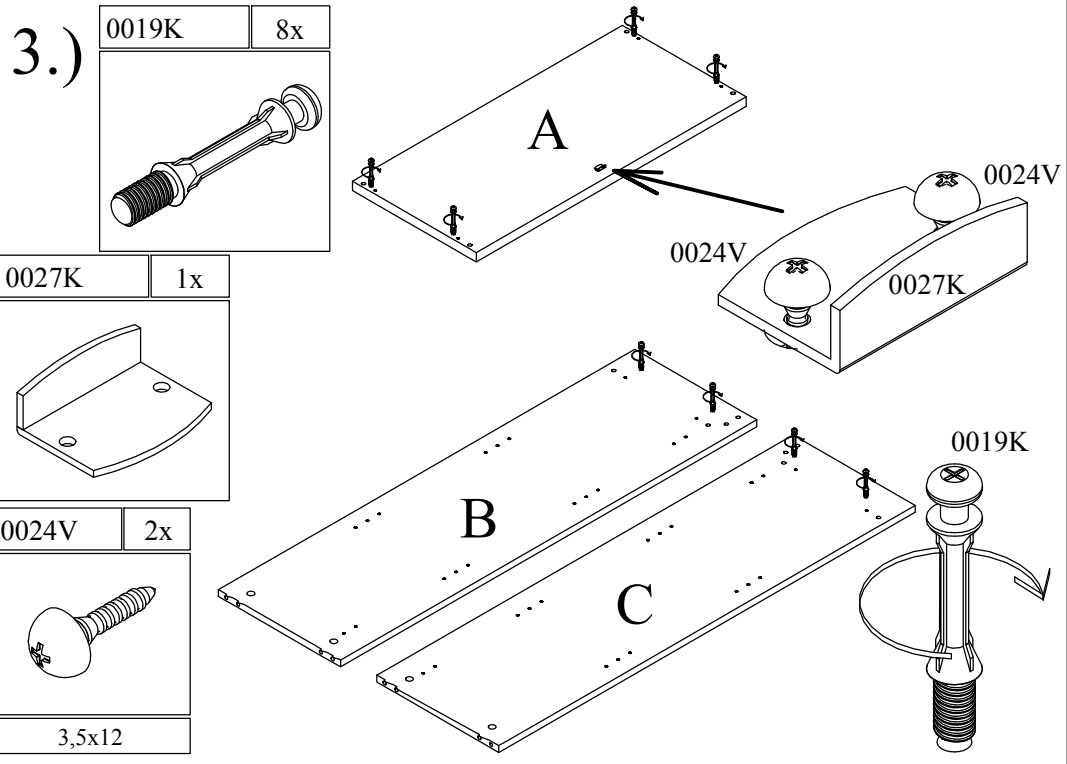

7.)

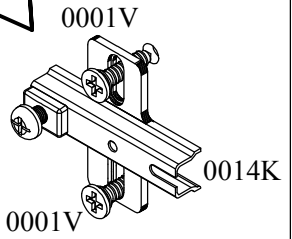
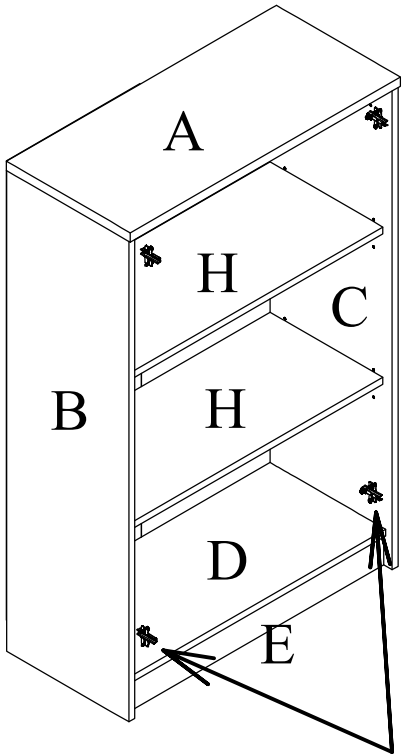
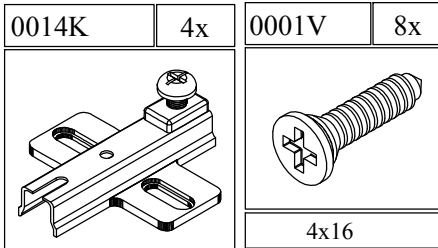

8.)

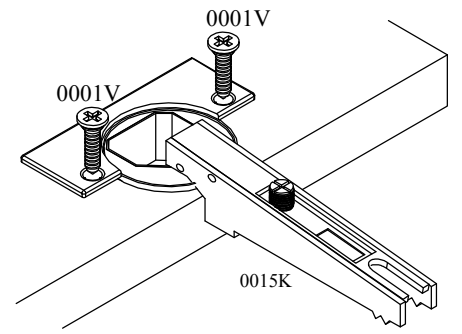
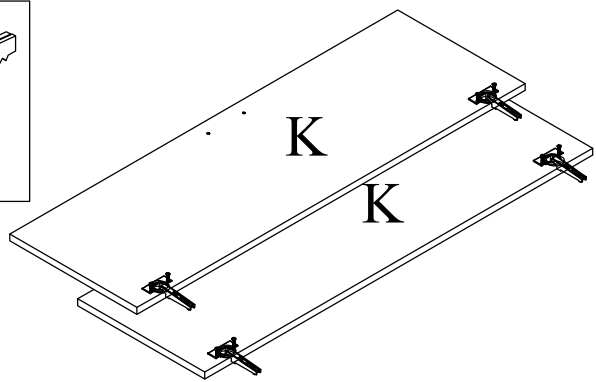
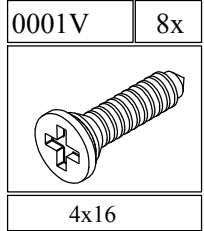
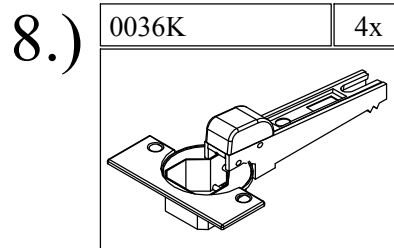

9.)

